



# RESOURCE SAVER™ AUTOMATIC WASHER

## Use & Care Guide

For questions about features, operation/performance, parts, accessories or service call: 1-800-253-1301

In Canada, for assistance call: 1-800-461-5681, for installation and service call: 1-800-807-6777

or visit our website at [www.whirlpool.com](http://www.whirlpool.com) or [www.whirlpool.com/canada](http://www.whirlpool.com/canada)

---

Table of Contents.....	2
------------------------	---

---

---

# TABLE OF CONTENTS

<b>WASHER SAFETY .....</b>	<b>3</b>
<b>PARTS AND FEATURES .....</b>	<b>4</b>
<b>WASHER USE .....</b>	<b>5</b>
Understanding Washer Cycles .....	5
Loading.....	5
Normal Washer Sounds.....	5
Starting Your Washer.....	6
Selecting a Fabric Speed and Cycle Time .....	7
ACCUWASH™ Temperature Control System.....	8
High Efficiency Spray Rinse System.....	8
SMARTBLEACH™ Timed Bleach Dispenser .....	8
Self-Cleaning Lint Filter.....	8
<b>WASHER CARE .....</b>	<b>8</b>
Cleaning Your Washer .....	8
Water Inlet Hoses.....	8
Vacation, Storage, and Moving Care.....	8
<b>TROUBLESHOOTING.....</b>	<b>9</b>
<b>ASSISTANCE OR SERVICE .....</b>	<b>11</b>
In the U.S.A. ....	11
In Canada .....	11
<b>WARRANTY .....</b>	<b>12</b>

# WASHER SAFETY

## Your safety and the safety of others are very important.

We have provided many important safety messages in this manual and on your appliance. Always read and obey all safety messages.



This is the safety alert symbol.

This symbol alerts you to potential hazards that can kill or hurt you and others.

All safety messages will follow the safety alert symbol and either the word "DANGER" or "WARNING." These words mean:

**! DANGER**

You can be killed or seriously injured if you don't immediately follow instructions.

**! WARNING**

You can be killed or seriously injured if you don't follow instructions.

All safety messages will tell you what the potential hazard is, tell you how to reduce the chance of injury, and tell you what can happen if the instructions are not followed.

## IMPORTANT SAFETY INSTRUCTIONS

**WARNING:** To reduce the risk of fire, electric shock, or injury to persons when using the washer, follow basic precautions, including the following:

- Read all instructions before using the washer.
- Do not wash articles that have been previously cleaned in, washed in, soaked in, or spotted with gasoline, dry-cleaning solvents, other flammable, or explosive substances as they give off vapors that could ignite or explode.
- Do not add gasoline, dry-cleaning solvents, or other flammable, or explosive substances to the wash water. These substances give off vapors that could ignite or explode.
- Under certain conditions, hydrogen gas may be produced in a hot water system that has not been used for 2 weeks or more. **HYDROGEN GAS IS EXPLOSIVE.** If the hot water system has not been used for such a period, before using the washing machine, turn on all hot water faucets and let the water flow from each for several minutes. This will release any accumulated hydrogen gas. As the gas is flammable, do not smoke or use an open flame during this time.
- Do not allow children to play on or in the washer. Close supervision of children is necessary when the washer is used near children.
- Before the washer is removed from service or discarded, remove the lid.
- Do not reach into the washer if the tub or agitator is moving.
- Do not install or store the washer where it will be exposed to the weather.
- Do not tamper with controls.
- Do not repair or replace any part of the washer or attempt any servicing unless specifically recommended in this Use and Care Guide or in published user-repair instructions that you understand and have the skills to carry out.
- See Installation Instructions for grounding requirements.

**SAVE THESE INSTRUCTIONS**

# PARTS AND FEATURES

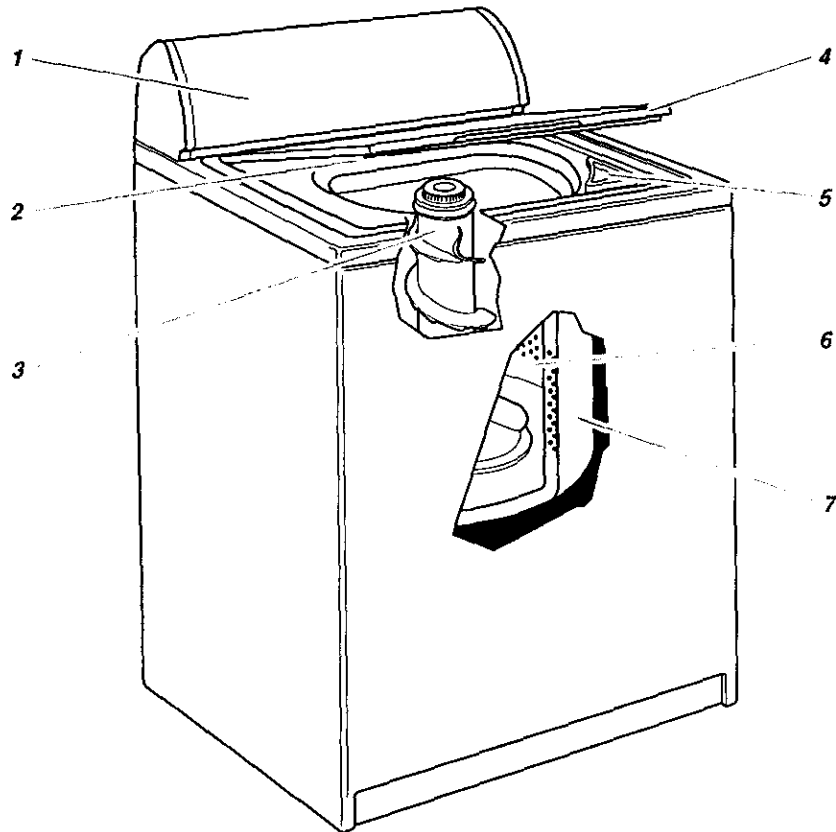

1. Control panel
2. Model and serial number label
3. XTRA ROLL ACTION™ PLUS agitator
4. Lid
5. SMARTBLEACH™ timed bleach dispenser
6. DURASMOOTH™ white porcelain basket
7. Tub

**Additional features**  
 MAGIC CLEAN® lint filter  
 ACCUWASH™ temperature control system

## Control panel

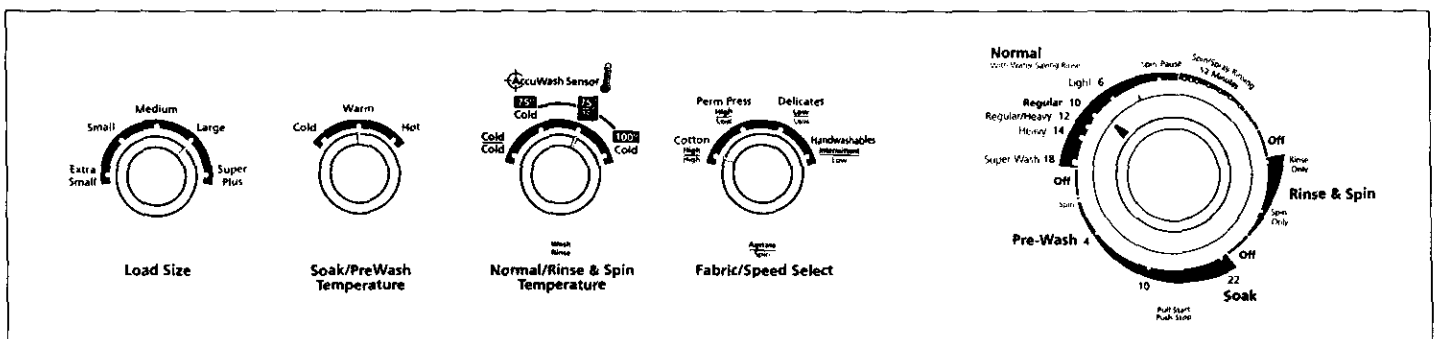

# WASHER USE

## Understanding Washer Cycles









When the Cycle Control knob is set to a number and pulled out, the washer fills (to the selected load size) before agitation and timing start. The washer begins agitating immediately after filling; agitation occurs with the washer lid up or down.

During agitation, the agitator creates a continuous rollover action that provides a thorough cleaning of the wash load.



After agitation starts, the Cycle Control knob turns clockwise until it points to an OFF area and the cycle ends.

**NOTE:** The washer pauses briefly throughout each cycle. These pauses are normal for washer operation.

WASH	RINSE
 1. Fill	 1. Spin-No fill
 2. Wash selected time	 2. Spray rinses-Spin
 3. Drain No agitation	 3. Spin
 4. Spin	 4. Off
 5. Pause-No spin	

## Loading

### Loading suggestions

For these suggested full-sized loads, set the LOAD SIZE selector to the highest load size setting.

### SUPER CAPACITY™ PLUS WASHERS

#### Heavy Work Clothes

3 pair pants	1 coverall
3 shirts	1 overall
4 pair jeans	

#### Delicates

3 camisoles	2 bras
1 quilted robe	2 nighties
4 slips	1 baby's dress
4 panties	

#### Towels

10 bath towels	14 wash cloths
10 hand towels	1 bath mat

#### Mixed Load

3 double sheets	2 shirts
4 pillowcases	2 blouses
8 T-shirts	8 handkerchiefs
6 pair shorts	

## Normal Washer Sounds

Your new washer may make sounds your old one didn't. Because the sounds might be unfamiliar, you may be concerned about them. These sounds are normal.

### During washing

When you select a small load size setting, your washer has a lower water level. This can cause a clicking sound from the upper part of the agitator.

### During drain

If water is drained quickly from your washer (depending on your installation), you may hear air being pulled through the pump during the end of draining.

### After drain and before spin

When the cycle changes from draining to spinning, you may hear gears engaging.

## Starting Your Washer

### ⚠ WARNING



#### Fire Hazard

Never place items in the washer that are dampened with gasoline or other flammable fluids.

No washer can completely remove oil.

Do not dry anything that has ever had any type of oil on it (including cooking oils).

Doing so can result in death, explosion, or fire.

### ⚠ WARNING



#### Electrical Shock Hazard

Plug into a grounded 3 prong outlet.

Do not remove ground prong.

Do not use an adapter.

Do not use an extension cord.

Failure to follow these instructions can result in death, fire, or electrical shock.

1. Measure detergent and pour it into the washer. If desired, add powdered or liquid color safe bleach. Use less detergent when using a small load size.



Drop a sorted load of clothes loosely into your washer.

- Load evenly to maintain washer balance. Mix large and small items.
- Items should move easily through the wash water. Overloading can cause poor cleaning.
- To reduce wrinkling of permanent press clothes and some synthetic knits, use a large load size to provide more space (see step 4).

2. (OPTIONAL STEP) Pour measured liquid chlorine bleach into the liquid chlorine bleach dispenser. Bleach will be dispensed automatically during the wash part of the cycle. See "SMARTBLEACH" Timed Bleach Dispenser."

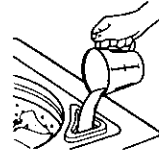

- Never use more than 1 cup (250 mL) for a full load. Use less with a smaller load size.
  - Follow the manufacturer's directions for safe use.
  - To avoid spilling, use a cup with a pouring spout. Do not let bleach splash, drip, or run down into the washer basket.
  - Use only liquid chlorine bleach in this dispenser.
3. Close the washer lid.
  4. Turn the LOAD SIZE selector to the correct setting for your wash load and the type of fabric being washed.
    - Choose a load size that allows the load to move freely for best fabric care. See "Loading."
    - You may change the load size selection after the washer has started filling by turning the selector to a different setting.

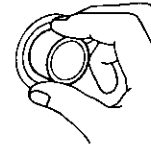

5. If a Soak or Prewash cycle is desired, set the SOAK/ PREWASH TEMPERATURE selector to the desired setting
  - Match the water temperature with the type of fabrics and soils in your load.
  - The water temperature for this cycle is not regulated with the ACCUWASH Temperature Control System.

Water Temp	Use For
<b>Hot</b> 111°F (44°C) or above	Whites and pastels Heavy and greasy soils
<b>Warm</b> 90°-110°F (32°-43°C)	Bright colors Moderate to light soils
<b>Cold</b> 70°-90°F (21°-32°C)	Colors that bleed or fade Light soils

6. Select a Normal wash temperature or a Rinse & Spin temperature with the NORMAL/RINSE & SPIN TEMPERATURE selector.
  - Match the water temperature with the type of fabrics and soils in your load.
  - Your washer uses ACCUWASH™ temperature control to regulate incoming hot and cold water in the Normal wash cycle and Rinse & Spin cycle. See "ACCUWASH Temperature Control System."
7. Turn the FABRIC/SPEED SELECT to the setting that matches the type of fabric in your load. See "Selecting a Fabric Speed and Cycle Time."
  - The selector lets you customize your wash cycles for 4 types of fabrics: Cotton, Perm Press, Delicates and Handwashables.
  - The selections provide different agitation and spin speeds.

8. Push in the Cycle Control knob and turn it to the wash cycle you want. Reduce the wash time when using a small load size setting. See "Selecting a Fabric Speed and Cycle Time."



Pull out the Cycle Control knob to start the washer.

**To stop or restart your washer**

- To **stop** the washer at any time, push in the Cycle Control knob.
- To **restart** the washer, close the lid (if open) and pull out the Cycle Control knob.

## Selecting a Fabric Speed and Cycle Time

This section describes the available wash cycles and will help you make the best cycle selections for your wash loads. The FABRIC/SPEED SELECT is used with the Cycle Control knob to design a cycle to match the fabrics and soil levels in your load.

- The washer pauses briefly throughout each cycle. These pauses are normal. Refer to "Normal Washer Sounds" to learn more about the sounds you may hear during a wash cycle.
- Refer to "Understanding Washer Cycles" to learn what happens during a wash cycle.

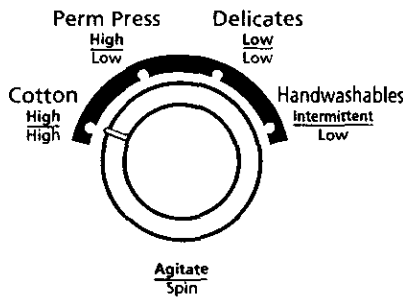

Fabric/Speed Select

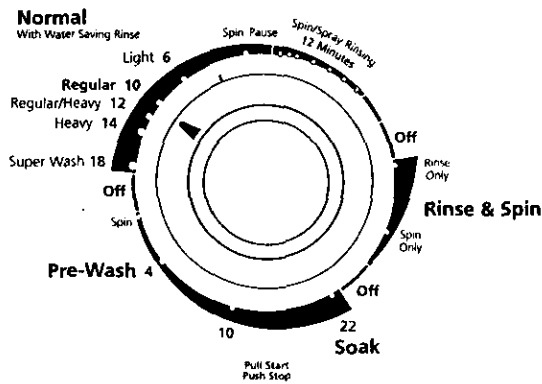

Cycle Control knob

**Normal cycle**

The Normal cycle is used with the FABRIC/SPEED SELECT to provide the best wash and spin action for your load. Select 6, 10, 12 or 14 minutes of wash time depending on the soil levels in your load. (See chart.)

**Super Wash** - Select the 18-minute Super Wash feature to wash heavily soiled loads that need maximum soil removal.

FABRIC/SPEED Setting	CYCLE CONTROL Setting	LOAD TYPE
Cotton	Super Wash	Sturdy fabrics <i>Maximum soil removal</i>
Perm Press or Cotton	Heavy	Sturdy fabrics <i>Removes heavy soils</i>
Perm Press or Cotton	Regular/Heavy	Cottons <i>Removes moderate to heavy soils</i>
Perm Press or Cotton	Regular	Permanent Press Synthetic <i>Removes moderate soils</i>
Delicates	Light	Delicate Washable knits Linens <i>Gentle cleaning for light soils</i> <i>Better water removal for faster drying times</i>
Hand-washables	Light	Handwashables <i>Gentle cleaning for special-care items</i>

**Rinse & Spin cycle**

When washing heavily soiled clothes, or washing special-care items, you may find an extra rinse and spin is needed. Choosing Spin Only can help shorten drying times by removing excess water.

- For a rinse and spin, turn the Cycle Control knob to RINSE ONLY.
- For a spin only, turn the Cycle Control knob to SPIN ONLY.

**NOTE:** Rinse water temperature and spin speed will be the same as your previous wash cycle unless new selections are made.

**Soak cycle**

The Soak cycle features brief periods of agitation and soak time to help remove heavy soils and stains that need pretreatment. Select 10 or 22 minutes of soak time, depending on the soil level of your load.

**For high speed agitation,** set the FABRIC/SPEED SELECT to COTTON or PERM PRESS.

**For low speed agitation,** set the FABRIC/SPEED SELECT to DELICATES.

**For intermittent agitation,** set the FABRIC/SPEED SELECT to HANDWASHABLES.

- Select a Soak/Prewash Temperature to match the type of fabric and soils in your load.
- Use the amount of detergent or presoak additive recommended by manufacturer.
- The Soak cycle automatically advances into the Pre-Wash cycle.
- After the cycle ends, set a new wash cycle.

### Pre-Wash cycle

The Pre-Wash cycle features 4 minutes of agitation to help remove heavy soils and stains that need pretreatment. This cycle provides additional washing prior to the desired cycle. Because the Pre-Wash cycle does not rinse, a new wash cycle should be selected after the Pre-Wash cycle ends.

**For high speed agitation,** set the FABRIC/SPEED SELECT to COTTON or PERM PRESS.

**For low speed agitation,** set the FABRIC/SPEED SELECT to DELICATES.

**For intermittent agitation,** set the FABRIC/SPEED SELECT to HANDWASHABLES.

- Select a Soak/Prewash Temperature to match the type of fabric and soils in your load.
- Use Pre-Wash for heavily soiled loads that need more than one wash.
- After the cycle ends, set a new wash cycle.

### ACCUWASH™ Temperature Control System

Your washer uses the ACCUWASH automatic temperature control in the Normal wash cycle and Rinse and Spin cycle. The ACCUWASH feature maintains a uniform water temperature by regulating incoming hot and cold water. This helps eliminate undissolved detergent and ensures consistent cleaning results.

- Select a wash water temperature of 75°F (24°C) for items that bleed, handwashables, or lightly soiled items.
- Select a wash water temperature of 100°F (38°C) for cleaning whites and bright colors or moderately to heavily soiled items.

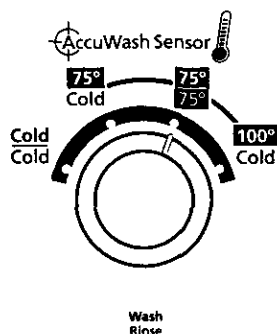

### High Efficiency Spray Rinse System

The washing portion for this system ends with a drain and spin the same as do traditional wash cycles. After that, the spray rinse system begins.

Fresh water is added as the machine spins the load. Repeated spinning with spray rinses achieves excellent rinsing results and uses less water than does a traditional rinse cycle.



No fill



Spray rinsing and spinning

**To assure proper spray rinsing:**

- Do not open the washer lid during spray rinsing.
- Do not use liquid fabric softeners. You could stain your clothes. Use a fabric softener sheet in the dryer instead.

### SMARTBLEACH™ Timed Bleach Dispenser

The timed bleach dispenser automatically dispenses liquid chlorine bleach to the wash load at the appropriate time during the cycle to help ensure the cleanest and brightest loads. Bleach is dispensed into the wash load a few minutes after agitation begins in order to give the detergent time to achieve the best soil and stain removal.

**NOTE:** Do not use this dispenser to add powdered chlorine or color-safe bleach to your wash load. The dispenser is for liquid chlorine bleach only.

### Self-Cleaning Lint Filter

Your washer has a self-cleaning lint filter at the bottom of the basket. Wash and rinse water flow over the filter during agitation, separating the lint from the water. The lint spins out of the system during the spin part of the cycle.

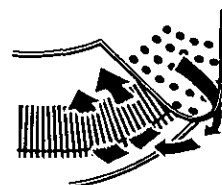

If your washer drains into a tub, remove any lint collected in the tub or strainer.

## WASHER CARE

### Cleaning Your Washer

#### Cleaning the exterior

Use a soft, damp cloth or sponge to wipe up any spills such as detergent or bleach. Occasionally wipe the outside of your washer to keep it looking new.

#### Cleaning the interior

Clean your washer interior by mixing 1 cup (250 mL) of chlorine bleach and 2 cups (500 mL) of detergent. Pour this into your washer and run it through a complete cycle using hot water. Repeat this process if necessary.

**NOTE:** Remove any hard water deposits using only cleaners labeled as washer safe.

### Water Inlet Hoses

Replace inlet hoses after five years of use to reduce the risk of hose failure. Periodically inspect and replace inlet hoses if bulges, kinks, cuts, wear or leaks are found.

When replacing your inlet hoses, mark the date of replacement on the label with a permanent marker.

### Vacation, Storage, and Moving Care

Install and store your washer where it will not freeze. Because some water may stay in the hoses, freezing can damage your washer. If storing or moving your washer during freezing weather, winterize it.



### Non-use or vacation care

Operate your washer only when you are at home. If you will be on vacation or not using your washer for an extended period of time, you should:

- Unplug washer or disconnect power.
- Turn off the water supply to the washer. This helps avoid accidental flooding (due to a water pressure surge) while you are away.

### To winterize washer

1. Shut off both water faucets.
2. Disconnect and drain water inlet hoses.
3. Put 1 quart (1 L) of R.V.-type antifreeze in the basket.
4. Run washer on a drain and spin setting (see "Drain and Spin") for about 30 seconds to mix the antifreeze and water.
5. Unplug washer or disconnect power.

### To use washer again

1. Flush water pipes and hoses.
2. Reconnect water inlet hoses.
3. Turn on both water faucets.
4. Plug in washer or reconnect power.
5. Run the washer through a complete cycle with 1 cup (250 mL) of detergent to clean out antifreeze.

## TROUBLESHOOTING

First try the solutions suggested here and possibly avoid the cost of a service call...

### Washer won't fill, rinse or agitate

- **Check the following:**
  - Is the power cord plugged into a grounded 3 prong outlet?
  - Is the indicator on the Cycle Control knob properly lined up with a cycle? Turn the Cycle Control knob to the right slightly and **pull to start**.
  - Are the water inlet valve screens clogged?
  - Are both the hot and cold water faucets turned on?
  - Is the water inlet hose kinked?
- **Does the water level seem too low, or does the washer appear to not fill completely?**
  - The top of the agitator is much higher than the highest water level. This creates a perception that the washer is not filling completely. This is normal.

### Washer stops

- **Check the following:**
  - Is the power cord plugged into a grounded 3 prong outlet?
  - Is the indicator on the Cycle Control knob properly lined up with a cycle? Turn the Cycle Control knob to the right slightly and **pull to start**.
  - Are the water inlet valve screens clogged?
  - Are both the hot and cold water faucets turned on?
  - Is the water inlet hose kinked?
- **Is there power at the plug?**
  - Check your electrical source or call an electrician.
- **Has a fuse blown or is the circuit breaker open?**
  - If problem continues, call an electrician.
- **Are you using an extension cord?**
  - Do not use an extension cord.

- **Is the washer in a normal pause in the Permanent Press (or Hand Washables) cycle?**

The washer pauses for about 2 minutes in the Permanent Press cycle. Allow the cycle to continue.

The Hand Washables cycle features periods of agitation and soak.

- **Is the washer overloaded?**
  - Wash smaller loads.

### Washer won't drain or spin

- **Is the drain hose clogged, or the end of the drain hose more than 72 inches (183 cm) above the floor?**
  - See the Installation Instructions for proper installation of drain hose.
- **Is the lid open?**
  - The lid must be closed during operation.
- **Is there excessive sudsing?**
  - Always measure detergent. Follow manufacturer's directions. If you have very soft water, you might need to use less detergent.
- **Is your voltage low?**
  - Check your electrical source or call an electrician. Do not use an extension cord.

### Washer continues to fill or drain, or the cycle seems stuck

- **Is the top of drain hose lower than the water level in washer?**
  - The top of the hose must be higher than the water level in the washer for proper operation. See the Installation Instructions.
- **Does the drain hose fit too tightly in the standpipe, or is it taped to the standpipe?**
  - The drain hose should be loose yet fit securely. Do not seal the drain hose with tape. The hose needs an air gap. See the Installation Instructions.

### Washer makes noise

- **Is the load balanced and the washer level?**
  - The wash load should be balanced and not overloaded.
  - The washer must be level. The front feet should be properly installed and the nuts tightened. Reset the rear leveling legs (if needed). See the Installation Instructions.
- **Did you completely remove the yellow shipping strap with cotter pins?**
  - See the Installation Instructions.
- **Are the gears engaging after the drain and before spin, or is the upper part of agitator clicking during wash?**
  - These are normal washer noises.

### Washer leaks

- **Check the following:**
  - Are the fill hoses tight? Are the fill hose washers properly seated? Is the drain hose clamp properly installed? See the Installation Instructions.
- **Is the sink or drain clogged?**
  - Sink and standpipe must be able to handle 17 gallons (64 L) of water per minute.
- **Is water deflecting off the tub ring or the load?**
  - Center the tub before starting the washer.
  - The wash load should be balanced and not overloaded. The fill or spray rinses can deflect off the load.
  - The washer must be level. The front feet should be properly installed and the nuts tightened. Reset the rear leveling legs (if needed). See the Installation Instructions.
- **Check household plumbing for leaks.**

---

### Washer basket is crooked

---

- **Was the washer basket pulled forward during loading?**  
The wash load should be balanced and not overloaded. Push the basket to the center before starting wash.
- **Is the load balanced and the washer level?**  
The wash load should be balanced and not overloaded.  
  
The washer must be level. The front feet should be properly installed and the nuts tightened. Reset the rear leveling legs (if needed). See the Installation Instructions.
- **The washer basket moves while washing.**  
This is normal.

---

### Agitator operation

---

- **The top of the agitator is loose, or moves in only one direction.**  
This is normal.

---

### Dispenser clogged or bleach leaking

---

- **Did you put powdered or color-safe bleach in the liquid chlorine bleach dispenser?**  
Add powdered or liquid color-safe bleach directly to the basket. Do not use the chlorine bleach dispenser for color-safe bleach.

---

### Load too wet

---

- **Did you use the right cycle for the load being washed?**  
Select a cycle with a higher spin speed (if available).
- **Did you use a cold rinse?**  
Cold rinses leave loads wetter than warm rinses. This is normal.

---

### Residue or lint on load

---

- **Did you sort properly?**  
Sort lint givers (towels, chenille) from lint takers (corduroy, synthetics). Also sort by color.
- **Did you overload the washer?**  
The wash load must be balanced and not overloaded. Lint can be trapped in the load if overloaded. Wash smaller loads.
- **Check the following:**  
Was paper or tissue left in the pockets?  
  
Did you use enough detergent? Follow manufacturer's directions. Use enough detergent to hold the lint in the water.  
  
Is your water colder than 70°F (21°C)? Wash water colder than 70°F (21°C) may not completely dissolve the detergent.

---

### Stains on load

---

- **Did you follow the manufacturer's directions when adding detergent?**  
Measure detergent. Use enough detergent to remove soil and hold it in suspension.
- **Did you use a liquid fabric softener?**  
Do not use liquid fabric softeners. Use a fabric softener sheet in the dryer instead.
- **Is there above average iron (rust) in water?**  
You may need to install an iron filter.
- **Did you properly sort the load?**  
Sort dark clothes from whites and lights.
- **Did you unload the washer promptly?**  
To avoid dye transfer, unload the washer as soon as it stops.

---

### Load is wrinkled

---

- **Did you unload the washer promptly?**  
Unload the washer as soon as it stops.
- **Did you use the right cycle for the load being washed?**  
Use the Permanent Press cycle or another cycle with low spin speeds (if available) to reduce wrinkling.
- **Did you overload the washer?**  
The wash load must be balanced and not overloaded. Loads should move freely during washing.
- **Was the wash water warm enough to relax wrinkles, or are you using warm rinses?**  
If safe for the load, use 100°F (38°C) wash water. Use cold rinse water.
- **Are the hot and cold water hoses reversed?**  
Check to be sure the hot and cold water hoses are connected to the right faucets. See the Installation Instructions.

---

### Load is tangled or twisted

---

- **Did you overload the washer?**  
The wash load must be balanced and not overloaded. Loads should move freely during washing.
- **Did you wrap items around the agitator?**  
Drop items loosely into the washer. Do not wrap items around the agitator.

---

### Gray whites, dingy colors

---

- **Did you properly sort the load?**  
Dye transfer can occur when mixing whites and colors in a load. Sort dark clothes from whites and lights.
- **Was the wash temperature too low?**  
Use 100°F (38°C) wash water, if safe for the load, to clean heavy or greasy soils. Cleaning some heavy or greasy soils may require Soak or Pre-wash.
- **Did you use enough detergent, or do you have hard water?**  
Use more detergent for washing heavy soils in cold or hard water.
- **Are the hot and cold water hoses reversed?**  
Check to be sure the hot and cold water hoses are connected to the right faucets. See the Installation Instructions.

---

### Garment damage

---

- **Check the following:**  
Were sharp items removed from pockets before washing?  
Empty pockets, zip zippers, snap or hook fasteners before washing.  
  
Were strings and sashes tied to prevent tangling?  
  
Were items damaged before washing? Mend rips and broken threads in seams before washing.
- **Did you overload the washer?**  
The wash load must be balanced and not overloaded. Loads should move freely during washing.
- **Did you properly add chlorine bleach?**  
Do not pour chlorine bleach directly on load. Wipe up bleach spills. Undiluted bleach will damage fabrics.
- **Did you follow the manufacturer's care label instructions?**

---

# ASSISTANCE OR SERVICE

Before calling for assistance or service, please check "Troubleshooting." It may save you the cost of a service call. If you still need help, follow the instructions below.

When calling, please know the purchase date and the complete model and serial number of your appliance. This information will help us to better respond to your request.

## If you need replacement parts

If you need to order replacement parts, we recommend that you only use FSP® factory specified parts. These parts will fit right and work right because they are made with the same precision used to build every new WHIRLPOOL GOLD™ appliance.

### To locate FSP replacement parts in your area:

In the U.S.A., call the Consumer Assistance Center at **1-800-253-1301**, or your nearest designated service center.

In Canada, call **1-800-807-6777**, or your nearest designated service center.

---

## In the U.S.A.

Call the Whirlpool Consumer Assistance Center toll free:  
**1-800-253-1301**.

### Our consultants provide assistance with:

- Features and specifications on our full line of appliances.
- Installation information.
- Use and maintenance procedures.
- Accessory and repair parts sales.
- Specialized customer assistance (Spanish speaking, hearing impaired, limited vision, etc.).
- Referrals to local dealers, repair parts distributors, and service companies.

Whirlpool designated service technicians are trained to fulfill the product warranty and provide after-warranty service anywhere in the United States.

To locate the Whirlpool designated service company in your area, you can also look in your telephone directory Yellow Pages.

## For further assistance

If you need further assistance, you can write to Whirlpool Corporation with any questions or concerns at:

Whirlpool Brand Home Appliances  
Consumer Assistance Center  
c/o Correspondence Dept.  
2000 North M-63  
Benton Harbor, MI 49022-2692

Please include a daytime phone number in your correspondence.

---

## In Canada

Call the Inglis Limited Consumer Relations Center toll free:  
**1-800-461-5681** 8:30 a.m. - 6:00 p.m. (EST).

### Our consultants provide assistance with:

- Features and specifications on our full line of appliances.
- Referrals to local dealers.

## For service in Canada

Call **1-800-807-6777**. Inglis designated service technicians are trained to fulfill the product warranty and provide after-warranty service anywhere in Canada.

## For further assistance

If you need further assistance, you can write to Inglis Limited with any questions or concerns at:

Consumer Relations Center  
Inglis Limited  
1901 Minnesota Court  
Mississauga, Ontario L5N 3A7

Please include a daytime phone number in your correspondence

---

## Gearcase assembly covered by your warranty

