



Microwave Oven

Safety Instructions2-7

Operating Instructions

Auto Features16-22

 Auto Defrost 21

 Chicken 16

 Chicken Chart 19

 Melt 17

 Melt Chart 20

 Metal Rack 22

 Popcorn 16

 Quick Defrost 21

 Soften 17

 Soften Chart 20

 Time Defrost 22

Control Panel9

Cooking Guide24-28

Cookware23

Features of Your Oven 8

Microwave Oven Functions10-14

 Child Lock11

 Clock10

 Cooking at High Power Levels12

 Cooking at Lower Power Levels13

 Cooking Guide for
 Lower Power Levels 14

 Cooking with More
 Than One Cook Cycle13

 Hold Warm11

 Light10

 More/Less12

 Settings12

 Timer10

 Vent Fan10

Microwave Terms 36

Sensor Features15, 16, 18

 Sensor Cook 15

 Sensor Cook Chart 18

 Sensor Reheat 16

 Sensor Reheat Chart 18

Care and Cleaning

Charcoal Filters32

Grease Filters31

Inside29

Outside29

Replacing the Light Bulbs30

Stainless Steel29

Vent Filters31

Troubleshooting Tips 33, 34

Things That Are Normal
With Your Microwave Oven 35

Consumer Support

Consumer Support Back Cover

Optional Kits7

Warranty 39

**Owner's
Manual**

JVM2052

Write the model and serial numbers here:

Model # _____

Serial # _____

You can find them on a label when the door is open.

IMPORTANT SAFETY INSTRUCTIONS.

READ ALL INSTRUCTIONS BEFORE USING.

When using electrical appliances basic safety precautions should be followed, including the following:

▲ WARNING!

To reduce the risk of burns, electric shock, fire, injury to persons, or exposure to excessive microwave energy:

PRECAUTIONS TO AVOID POSSIBLE EXPOSURE TO EXCESSIVE MICROWAVE ENERGY

- (a) **Do Not Attempt** to operate this oven with the door open, since open-door operation can result in harmful exposure to microwave energy. It is important not to defeat or tamper with the safety interlocks.
- (b) **Do Not Place** any object between the oven front face and the door or allow soil or cleaner residue to accumulate on sealing surfaces.
- (c) **Do Not Operate** the oven if it is damaged. It is particularly important that the oven door close properly and that there is no damage to the:
 - (1) door (bent),
 - (2) hinges and latches (broken or loosened),
 - (3) door seals and sealing surfaces.
- (d) **The Oven Should Not** be adjusted or repaired by anyone except properly qualified service personnel.

Read and follow the specific precautions in the *Precautions to Avoid Possible Exposure to Excessive Microwave Energy* section above.

This appliance must be grounded. Connect only to a properly grounded outlet. See the *Grounding Instructions* section on page 6.

Install or locate this appliance only in accordance with the provided installation instructions.

This microwave oven is UL listed for installation over electric and gas ranges.

This microwave oven is not approved or tested for marine use.

This over-the-range oven is designed for use over ranges no wider than 36." It may be installed over both gas and electric cooking equipment.

Do not operate this appliance if it has a damaged power cord or plug, if it is not working properly, or if it has been damaged or dropped. If the power cord is damaged, it must be replaced by General Electric Service or an authorized service agent using a power cord available from General Electric.

Do not cover or block any openings on the appliance.

Use this appliance only for its intended use as described in this manual. Do not use corrosive chemicals or vapors in this appliance. This microwave oven is specifically designed to heat, dry or cook food, and is not intended for laboratory or industrial use.

To reduce the risk of fire in the oven cavity:

- Do not overcook food. Carefully attend appliance when paper, plastic or other combustible materials are placed inside the oven while cooking.
- Remove wire twist-ties and metal handles from paper or plastic containers before placing them in the oven.
- Do not use the oven for storage purposes. Do not leave paper products, cooking utensils or food in the oven when not in use.
- Do not pop popcorn in your microwave oven unless in a special microwave popcorn accessory or unless you use popcorn labeled for use in microwave ovens.
- If materials inside the oven ignite, keep the oven door closed, turn the oven off and disconnect the power cord, or shut off power at the fuse or circuit breaker panel. If the door is opened, the fire may spread.
- Do not use the Sensor Features twice in succession on the same food portion. If food is undercooked after the first countdown, use **Cook Time** for additional cooking time.

SAVE THESE INSTRUCTIONS

IMPORTANT SAFETY INSTRUCTIONS. READ ALL INSTRUCTIONS BEFORE USING.

GEAppliances.com

IMPORTANT SAFETY INSTRUCTIONS.

Thermometer—Do not use regular cooking or oven thermometers when cooking by microwave. The metal and mercury in these thermometers could cause **arcing** and possible damage to the oven. Do not use a thermometer in food you are microwaving unless the thermometer is designed or recommended for use in the microwave oven.

Do not clean with metal scouring pads. Pieces can burn off the pad and touch electrical parts involving risk of electric shock.

Do not store any materials, other than our recommended accessories, in this oven when not in use.

Do not store this appliance outdoors. Do not use this product near water—for example, in a wet basement, near a swimming pool, near a sink or in similar locations.

Keep power cord away from heated surfaces.

Do not immerse power cord or plug in water.

Some products such as whole eggs and sealed containers—for example, closed jars—are able to explode and should not be heated in this microwave oven. Such use of the microwave oven could result in injury.

It is important to keep the area clean where the door seals against the microwave. Use only mild, non-abrasive detergents applied with a clean sponge or soft cloth. Rinse well.

This appliance must only be serviced by qualified service personnel. Contact nearest authorized service facility for examination, repair or adjustment.

As with any appliance, close supervision is necessary when used by children.

Do not store anything directly on top of the microwave oven surface when the microwave oven is in operation.

Do not mount this appliance over a sink.

WARNING!



ARCING

If you see arcing, press the **Clear/Off** pad and correct the problem.

Arcing is the microwave term for sparks in the oven. Arcing is caused by:

The metal rack not installed correctly so it touches the microwave wall.

Metal or foil touching the side of the oven.

Turntable ring support not installed correctly.

Foil not molded to food (upturned edges act like antennas).

Metal, such as twist-ties, poultry pins or gold-rimmed dishes, in the microwave.

Recycled paper towels containing small metal pieces being used in the microwave.

SAVE THESE INSTRUCTIONS

Safety Instructions

Operating Instructions

Care and Cleaning

Troubleshooting Tips

Consumer Support

IMPORTANT SAFETY INSTRUCTIONS.

READ ALL INSTRUCTIONS BEFORE USING.

⚠ WARNING!



FOODS

Do not pop popcorn in your microwave oven unless in a special microwave popcorn accessory or unless you use popcorn labeled for use in microwave ovens.

Do not boil eggs in a microwave oven. Pressure will build up inside egg yolk and will cause it to burst, possibly resulting in injury.

Operating the microwave with no food inside for more than a minute or two may cause damage to the oven and could start a fire. It increases the heat around the magnetron and can shorten the life of the oven.

Foods with unbroken outer "skin" such as potatoes, hot dogs, sausages, tomatoes, apples, chicken livers and other giblets, and egg yolks should be pierced to allow steam to escape during cooking.

Superheated water

Liquids, such as water, coffee, or tea, are able to be overheated beyond the boiling point without appearing to be boiling. Visible bubbling or boiling when the container is removed from the microwave oven is not always present. This could result in very hot liquids suddenly boiling over when the container is disturbed or a spoon or other utensil is inserted into the liquid.

To reduce the risk of injury to persons:

- Do not overheat the liquid.
- Stir the liquid both before and halfway through heating it.
- Do not use straight-sided containers with narrow necks.
- After heating, allow the container to stand in the microwave oven for a short time before removing the container.
- Use extreme care when inserting a spoon or other utensil into the container.

Foods cooked in liquids (such as pasta) may tend to boil more rapidly than foods containing less moisture. Should this occur, refer to the *Care and cleaning of the oven* section for instructions on how to clean the inside of the oven.

Avoid heating baby food in glass jars, even with the lid off. Make sure all infant food is thoroughly cooked. Stir food to distribute the heat evenly. Be careful to prevent scalding when warming formula. The container may feel cooler than the formula really is. Always test the formula before feeding the baby.

Don't defrost frozen beverages in narrow-necked bottles (especially carbonated beverages). Even if the container is opened, pressure can build up. This can cause the container to burst, possibly resulting in injury.

Hot foods and steam can cause burns. Be careful when opening any containers of hot food, including popcorn bags, cooking pouches and boxes. To prevent possible injury, direct steam away from hands and face.

Do not overcook potatoes. They could dehydrate and catch fire, causing damage to your oven.

Cook meat and poultry thoroughly—meat to at least an INTERNAL temperature of 160°F and poultry to at least an INTERNAL temperature of 180°F. Cooking to these temperatures usually protects against foodborne illness.

SAVE THESE INSTRUCTIONS

IMPORTANT SAFETY INSTRUCTIONS.

READ ALL INSTRUCTIONS BEFORE USING.

GEAppliances.com



MICROWAVE-SAFE COOKWARE

Do not operate the oven in the microwave mode without the turntable and the turntable support seated and in place. The turntable must be unrestricted so it can rotate.

Make sure all cookware used in your microwave oven is suitable for microwaving. Most glass casseroles, cooking dishes, measuring cups, custard cups, pottery or china dinnerware which does not have metallic trim or glaze with a metallic sheen can be used. Some cookware is labeled "suitable for microwaving."

If you are not sure if a dish is microwave-safe, use this test: Place in the oven both the dish you are testing and a glass measuring cup filled with 1 cup of water—set the measuring cup either in or next to the dish. Microwave 30–45 seconds at high. If the dish heats, it should not be used for microwaving.



How to test for a microwave-safe dish.

If the dish remains cool and only the water in the cup heats, then the dish is microwave-safe.

Oversized food or oversized metal cookware should not be used in a microwave oven because they increase the risk of electric shock and could cause a fire.

Sometimes the oven floor, turntable and walls can become too hot to touch. Be careful touching the floor, turntable and walls during and after cooking.

If you use a meat thermometer while microwaving, make sure it is safe for use in microwave ovens.

Do not use recycled paper products. Recycled paper towels, napkins and waxed paper can contain metal flecks which may cause arcing or ignite. Paper products containing nylon or nylon filaments should be avoided, as they may also ignite.

Some styrofoam trays (like those that meat is packaged on) have a thin strip of metal embedded in the bottom. When microwaved, the metal can burn the floor of the oven or ignite a paper towel.

Use of the rack accessory:

- Remove the rack from the oven when not in use.
- Use pot holders when handling the rack and cookware. They may be hot.
- Be sure that the rack is positioned properly inside the oven to prevent product damage.
- Do not cover the rack or any part of the oven with metal foil. This will cause overheating of the microwave oven.

Do not use your microwave oven to dry newspapers.

Not all plastic wrap is suitable for use in microwave ovens. Check the package for proper use.

Paper towels, waxed paper and plastic wrap can be used to cover dishes in order to retain moisture and prevent spattering while microwaving. Be sure to vent plastic wrap so steam can escape.

Cookware may become hot because of heat transferred from the heated food. Pot holders may be needed to handle the cookware.

When microwaving "boilable" cooking pouches and tightly closed plastic bags, they should be slit, pierced or vented as directed by package. If they are not, plastic could burst during or immediately after cooking, possibly resulting in injury. Also, plastic storage containers should be at least partially uncovered because they form a tight seal. When cooking with containers tightly covered with plastic wrap, remove covering carefully and direct steam away from hands and face.

Use foil only as directed in this manual. When using foil in the microwave oven, keep the foil at least 1" away from the sides of the oven.

Plastic cookware—Plastic cookware designed for microwave cooking is very useful, but should be used carefully. Even microwave-safe plastic may not be as tolerant of overcooking conditions as are glass or ceramic materials and may soften or char if subjected to short periods of overcooking. In longer exposures to overcooking, the food and cookware could ignite.

Follow these guidelines:

- 1** Use microwave-safe plastics only and use them in strict compliance with the cookware manufacturer's recommendations.
- 2** Do not microwave empty containers.
- 3** Do not permit children to use plastic cookware without complete supervision.

SAVE THESE INSTRUCTIONS

Safety Instructions

Operating Instructions

Care and Cleaning

Troubleshooting Tips

Consumer Support

IMPORTANT SAFETY INFORMATION. READ ALL INSTRUCTIONS BEFORE USING.

⚠ WARNING!

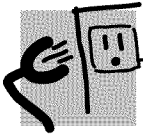

GROUNDING INSTRUCTIONS

WARNING: *Improper use of the grounding plug can result in a risk of electric shock.*

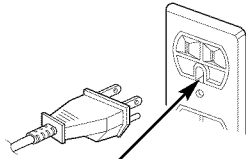

Ensure proper ground exists before use.

This appliance must be grounded. In the event of an electrical short circuit, grounding reduces the risk of electric shock by providing an escape wire for the electric current.

This appliance is equipped with a power cord having a grounding wire with a grounding plug. The plug must be plugged into an outlet that is properly installed and grounded.

Consult a qualified electrician or service technician if the grounding instructions are not completely understood, or if doubt exists as to whether the appliance is properly grounded.

If the outlet is a standard 2-prong wall outlet, it is your personal responsibility and obligation to have it replaced with a properly grounded 3-prong wall outlet.

Do not under any circumstances cut or remove the third (ground) prong from the power cord.

Do not use an adapter plug with this appliance.

Do not use an extension cord with this appliance. If the power cord is too short, have a qualified electrician or service technician install an outlet near the appliance.

For best operation, plug this appliance into its own electrical circuit to prevent flickering of lights, blowing of fuse or tripping of circuit breaker.

THE VENT FAN

The fan will operate automatically under certain conditions (see Vent Fan section). Take care to prevent the starting and spreading of accidental cooking fires while the vent fan is in use.

Clean the underside of the microwave often. Do not allow grease to build up on the microwave or the fan filters.

In the event of a grease fire on the surface units below the microwave oven, smother a flaming pan on the surface unit by covering the pan completely with a lid, a cookie sheet or a flat tray.

Use care when cleaning the vent fan filters. Corrosive cleaning agents, such as lye-based oven cleaners, may damage the filters.

When preparing flaming foods under the microwave oven, turn the fan on.

Never leave surface units beneath your microwave oven unattended at high heat settings. Boilovers cause smoking and greasy spillovers that may ignite and spread if the microwave vent fan is operating. To minimize automatic fan operation, use adequate sized cookware and use high heat on surface units only when necessary.

SAVE THESE INSTRUCTIONS

IMPORTANT SAFETY INSTRUCTIONS. READ ALL INSTRUCTIONS BEFORE USING.

GEAppliances.com

PACEMAKERS

Most pacemakers are shielded from interference from electronic products, including microwaves. However, patients with pacemakers may wish to consult their physicians if they have concerns.



READ AND FOLLOW THIS SAFETY INFORMATION CAREFULLY.

SAVE THESE INSTRUCTIONS

Optional kits

Available at extra cost from your GE supplier.

Filler Panel Kits

JX52WH—White

JX52BL—Black

When replacing a 36" range hood, filler panel kits fill in the additional width to provide a custom built-in appearance.

For installation between cabinets only; not for end-of-cabinet installation. Each kit contains two 3" wide filler panels.

Filter Kits

JX81D—Recirculating Charcoal Filter Kit

Filter kits are used when the oven cannot be vented to the outside.

Available at extra cost from your GE supplier. See the back cover for ordering by phone or at GEAppliances.com.

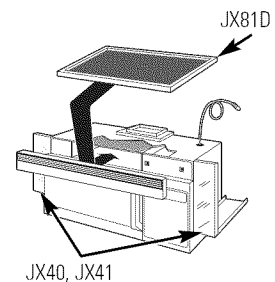

Safety Instructions

Operating Instructions

Care and Cleaning

Troubleshooting Tips

Consumer Support

About the features of your oven.

Throughout this manual, features and appearance may vary from your model.

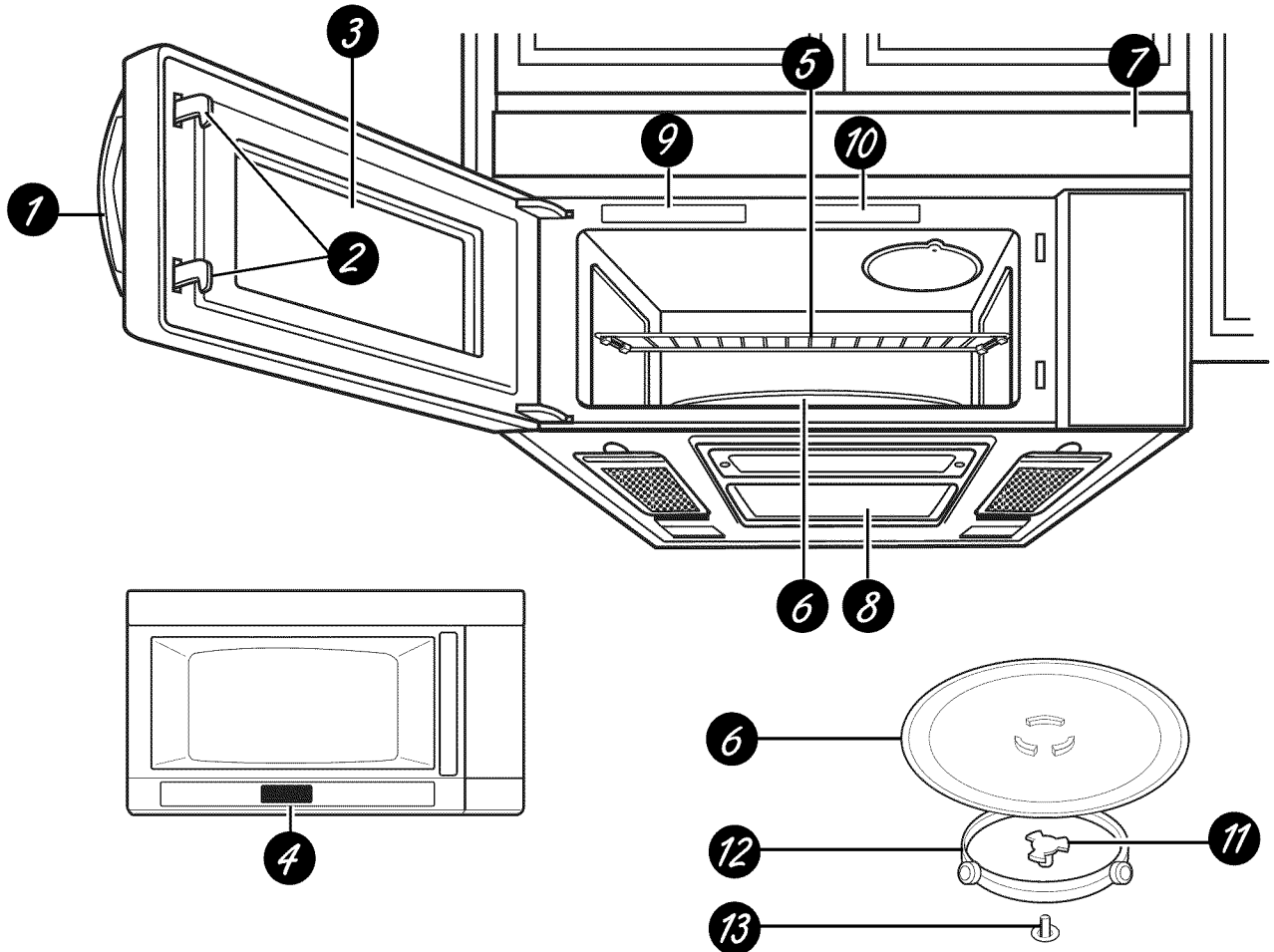

To Install:

1. Place the support on the oven cavity bottom.
2. Place the turntable on the support.

Fit the raised, curved lines in the center of the turntable bottom between the three spokes of the hub. The rollers on the support should fit inside the turntable bottom ridge.

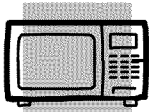

Features of the Oven

- | | |
|---|---|
| 1 Door Handle. | 7 Vent Grille. |
| 2 Door Latches. | 8 Cooktop/Countertop Light. |
| 3 Window with Metal Shield. Screen allows cooking to be viewed while keeping microwaves confined in the oven. | 9 Model and Serial Number Plate. |
| 4 Control Panel. | 10 Cooking Guide. |
| 5 Metal Rack. | 11 Hub. |
| 6 Turntable. The turntable rotates in both directions to help cook food more evenly. Do not operate the microwave oven without the turntable in place. | 12 Support. |
| | 13 Shaft. |

About the control panel.

You can microwave by time, with the sensor features or with the auto features.

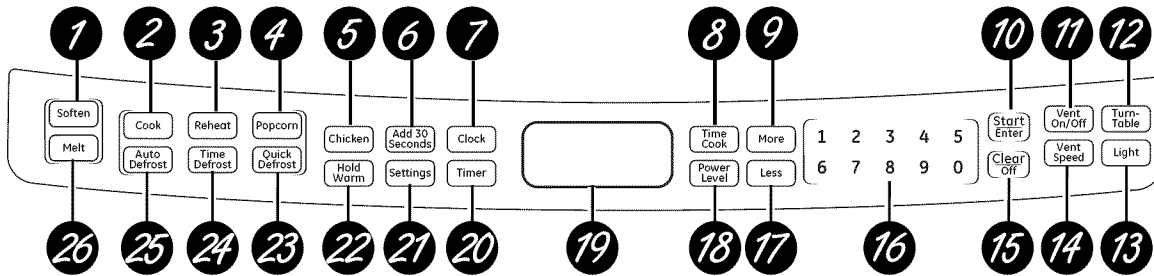

Cooking Controls

- 1 Soften.** Touch this pad to soften butter, ice cream, cream cheese and frozen juice.
- 2 Cook.** Touch this pad to cook baked potatoes, vegetable casseroles, rice and frozen entrées. The oven's sensor will tell the oven how long to cook depending on the amount of humidity coming from the food.
- 3 Reheat.** Touch this pad to reheat pizza, dinner plates, soup/sauce and casseroles. The oven's sensor will tell the oven how long to cook depending on the amount of humidity coming from the food.
- 4 Popcorn.** Touch this pad when popping popcorn in your microwave oven. The oven's sensor will tell the oven how long to cook depending on the amount of humidity it detects from the popcorn.
- 5 Chicken.** Touch this pad to cook chicken wings, chicken nuggets, spicy chicken and Mexican chicken.
- 6 Add 30 Seconds.** Touch this pad to add 30 more seconds to the cooking time.
- 7 Clock.** Touch this pad to enter the time of day.
- 8 Time Cook.** Touch this pad to set a cooking time.
- 9 More.** Touch this pad to add ten seconds of cooking time each time you press it.
- 10 Start/Enter.** Touch this pad to start a function. If you open the door after the oven begins to cook, touch **Start/Enter** again.
- 11 Vent On/Off.** Touch this pad to turn the fan on/off.
- 12 Turntable.** Touch this pad to turn on and off the turntable.
- 13 Light.** Touch this pad to turn the light on high, low or off.
- 14 Vent Speed.** Touch this pad to choose one of 5 fan speeds.
- 15 Clear/Off.** Touch this pad to stop the oven or to clear all entries.
- 16 Number Pads.** Touch number pads to enter cooking time, power level, quantities or weights.
- 17 Less.** Touch this pad to subtract ten seconds of cooking time each time you press it.
- 18 Power Level.** Touch this pad to select a cooking power level.
- 19 Display.** The display includes a clock and indicators to tell you time of day, cooking time setting and cooking functions selected.
- 20 Timer.** Touch this pad to set the timer.
- 21 Settings.** Touch this pad to change the oven's default setting for sound, clock, display speed and defrost weight.
- 22 Hold Warm.** Touch this pad to keep hot, cooked foods warm in your microwave oven for up to 90 minutes.
- 23 Quick Defrost.** Touch this pad to provide quick defrost for 1.0 pound of frozen food.
- 24 Time Defrost.** Touch this pad to defrost most other frozen foods.
- 25 Auto Defrost.** Touch this pad to select food type and defrost food (meat, poultry, fish and bread) by weight.
- 26 Melt.** Touch this pad to melt butter/margarine, chocolate, cheese and marshmallows.

About microwave oven functions.

Clock

This oven includes a 12-hour clock.

Example (setting 8:00 AM):



8 0 0



1 Touch **Clock**.

2 Enter the time by using the number pads.

3 Touch **Start/Enter**. (Press **1** for AM, **2** for PM.)

4 Touch **Start/Enter**.

Timer

You can use your microwave oven as a timer. Use the Timer for timing up to 99 minutes, and 99 seconds.

Example (setting 3 minutes):

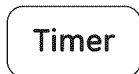

3 0 0



1 Touch **Timer**.

2 Enter the time by using the number pads.

3 Touch **Start/Enter**. When the time is over, you will hear beeps and **END** will display.

Vent Fan

The fan moves steam and other vapors from the cooking surface. There are five speeds.

Example (setting Level 4):



1 Touch **Vent On/Off**. This shows the last level until you select the fan speed level.

2 Touch **Vent Speed** until **LEVEL 4** appears in the display.

Touch **Vent On/Off** to turn off the fan when desired.

NOTE: If the temperature from the range or cooktop below the microwave oven gets too hot, the exhaust fan in the vent hood will automatically turn on at the **LEVEL 4** setting to protect the oven.

It may stay on up to an hour to cool the oven. When this occurs, the **Vent On/Off** pad will not turn the fan off.

Light

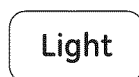

Touch **Light** once for bright light, twice for night light or three times to turn the light off.

Child Lock

You may lock the control panel to prevent the microwave oven from being accidentally started or used by children.

The **Child Lock** feature is also useful when cleaning the control panel. **Child Lock** prevents accidental programming when wiping the control panel.

To set Child Lock:

- 1** Touch **Clear/Off**.
- 2** Touch and hold **Start/Enter** more than 4 seconds. **LOCKED** will appear in the display window and two beeps will sound.

To cancel Child Lock:

Touch and hold **Start/Enter** more than 4 seconds. **LOCKED** will disappear and two beeps will sound.



Hold Warm

You can keep cooked food warm in your microwave oven for up to 90 minutes. You can use **Hold Warm** by itself or to follow a cooking cycle automatically.

- 1** Touch **Hold Warm**.

- 2** Touch **Start/Enter**.

NOTES:

- **Hold Warm** operates for up to 90 minutes.
- **Food cooked covered** should be covered during **Hold Warm**.
- **Pastry items** (pies, turnovers, etc.) should be uncovered during **Hold Warm**.
- Complete meals kept warm on a dinner plate can be covered during **Hold Warm**.

To make Hold Warm automatically follow another cycle:

While you are programming the cooking instructions, touch **Hold Warm** before touching **Start/Enter**.

- When the last cooking cycle is over, you will hear two beeps and **Hold Warm** will appear in the oven display.
- You can set **Hold Warm** to follow **Auto Defrost** or multi-cycle cooking.

| Food Type | Recommended Quantity |
|-----------|----------------------|
| Liquid | 1–2 cups |
| Dry | 5–10 oz. |



About microwave oven functions.

Settings

You can change the default values for beep sound, clock, display speed and defrost weight.

See the following chart for more information:

| No. | Function | No. | Result |
|-----|------------------------------|-----|--------------|
| 1 | Beep ON/Off control | 1 | Sound ON |
| | | 2 | Sound OFF |
| 2 | Clock display control | 1 | Clock ON |
| | | 2 | Clock OFF |
| 3 | Display | 1 | Slow Speed |
| | | 2 | Normal Speed |
| | | 3 | Fast Speed |
| 4 | Defrost weight mode selected | 1 | lbs. |
| | | 2 | kg. |

Example (changing defrost weight mode from lbs. to kg.):

Settings

4

2

1 Touch **Settings**.

2 Touch **4**.

3 Touch **2**.

More

Less

More/Less

By using the **More** or **Less** pads, all of the preprogrammed cook and time cook features can be adjusted to cook food for a longer or shorter time.

Touching **More** will add 10 seconds of cooking time each time you press it. Touching **Less** will subtract 10 seconds of cooking time each time you press it.

Cooking at High Power Levels

Example (cooking food for 8 minutes, 30 seconds at 100% power):

8 3 0

Start
Enter

1 Enter the cook time.

2 Touch **Start/Enter**.

When the cook time is over, four beeps will sound and **COOK END** will display.

Cooking at Lower Power Levels

HIGH power cooking does not always give you the best results with foods that need slower cooking, such as roasts, baked goods or custards.

Your oven has 10 power settings in addition to HIGH.

Example (cooking food for 7 minutes 30 seconds at 70% power):

7 3 0

Power
Level

7

Start
Enter

1 Enter the cook time.

2 Touch **Power Level**.

3 Enter the power level.

4 Touch **Start/Enter**.

When the cook time is over, four beeps will sound and **COOK END** will display.

See the *Cooking Guide for Lower Power Levels* on the next page.

Cooking with More Than One Cook Cycle

For best results, some recipes call for one Power Level for a certain length of time, and another Power Level for another length of time. Your oven can be set to change from one to another automatically, for up to three cycles if the first heating cycle is defrost.

Example (cooking food for 3 minutes at 100% power and then 70% power for 7 minutes 30 seconds):

3 0 0

Time
Cook

7 3 0

Power
Level

7

Start
Enter

1 Enter the first cook time.

2 Touch **Time Cook**.

3 Enter the second cook time.

4 Touch **Power Level**.

5 Enter the power level.

6 Touch **Start/Enter**.

When the cook time is over, four beeps will sound and **COOK END** will display.

About microwave oven functions.

Cooking Guide for Lower Power Levels

The 10 power levels in addition to HIGH allow you to choose the best power level for the food you are cooking. Below are listed all the power levels, examples of foods best cooked at each level and the amount of microwave power you are using.

| Power Level | Microwave Output | Use |
|-------------|------------------|--|
| 10 High | 100% | Boil water. Cook ground beef. Make candy. Cook fresh fruits and vegetables. Cook fish and poultry. Preheat browning dish. Reheat beverages. Bacon slices. |
| 9 | 90% | Reheat meat slices quickly. Saute onions, celery and green pepper. |
| 8 | 80% | All reheating. Cook scrambled eggs. |
| 7 | 70% | Cook breads and cereal products. Cook cheese dishes, veal. Cook cakes, muffins, brownies, cupcakes. |
| 6 | 60% | Cook pasta. |
| 5 | 50% | Cook meats, whole poultry. Cook custard. Cook whole chicken, turkey, spare ribs, rib roast, sirloin roast. |
| 4 | 40% | Cook less tender cuts of meat. Reheat frozen convenience foods. |
| 3 | 30% | Thaw meat, poultry and seafood. Cook small quantities of food. Finish cooking casseroles, stew and some sauces. |
| 2 | 20% | Soften butter and cream cheese. Heat small amounts of food. |
| 1 | 10% | Soften ice cream. Raise yeast dough. |
| 0 | 0% | Standing time. |

Humidity Sensor

What happens when using the Sensor Features:

The Sensor Features detect the increasing humidity released during cooking. The oven automatically adjusts the cooking time to various types and amounts of food.

Do not use the Sensor Features twice in succession on the same food portion—it may result in severely overcooked or burnt food. If food is undercooked after the countdown, use **Time Cook** for additional cooking time.

NOTE: Sensor features will not operate when the oven is hot. If one of the sensor cooking pads is touched when the temperature inside the oven is greater than 200°F, "OVEN TOO HOT FOR SENSOR COOKING---USING ALTERNATE METHOD" will be displayed. The oven will automatically change to cook by time (follow the directions in the display) or once the oven is cool enough, the sensor features will function normally.

The proper containers and covers are essential for best sensor cooking.

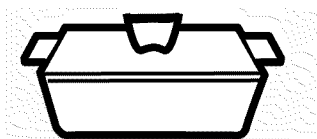

Covered

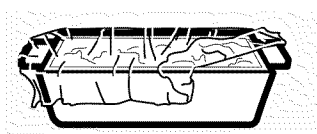

Vented

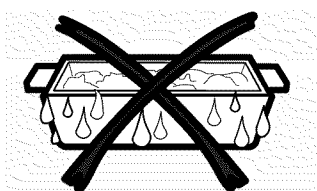

Dry off dishes so they don't mislead the sensor.

Always use microwave-safe containers and cover them with lids or vented plastic wrap. Never use tight sealing plastic containers—they can prevent steam from escaping and cause food to overcook.

Be sure the outside of the cooking containers and the inside of the microwave oven are dry before placing food in the oven. Beads of moisture turning into steam can mislead the sensor.

Sensor Cook

Using **Sensor Cook** lets you heat common microwave-prepared foods without needing to program times and Cook Powers. **Sensor Cook** has preset Cook Power for 7 food categories.

Example (cooking rice):

- 1** Touch **Cook**.
- 2** Choose the food category.

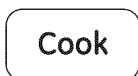

6

Sensor Cook Chart

| Category | Touch Pad Number | Amount |
|------------------|------------------|------------|
| Baked Potato | 1 | 1-4 each |
| Fresh Vegetable | 2 | 1-4 cups |
| Frozen Vegetable | 3 | 1-4 cups |
| Canned Vegetable | 4 | 1-4 cups |
| Casserole | 5 | 1-4 cups |
| Rice | 6 | 1/2-2 cups |
| Frozen Entrée | 7 | 10-21 oz. |

When the cook time is over, four beeps will sound and **COOK END** will display.

About the sensor and auto microwave features.

Sensor Reheat

Using **Sensor Reheat** lets you heat common microwave-prepared foods without needing to program times and power levels.

Example (reheating 2 slices of pizza):

Reheat

1

- 1** Touch **Reheat**.
- 2** Choose the food category.

Sensor Reheat Chart

| Category | Touch Pad Number | Amount |
|--------------|------------------|--------------|
| Pizza Slice | 1 | 1–3 slices |
| Dinner Plate | 2 | 1–2 servings |
| Soup/Sauce | 3 | 1–4 cups |
| Casserole | 4 | 1–4 cups |

When the reheat time is over, four beeps will sound and **COOK END** will display.

Chicken

The oven uses low power to cook poultry (chicken wings, chicken nuggets, Spicy chicken and Mexican chicken). See the Chicken Chart.

Example (cooking 6 oz. chicken wings):

Chicken

1

1

Start
Enter

- 1** Touch **Chicken**.
- 2** Choose the food category. Touch **1** for chicken wings.
- 3** Choose the amount by touching **1** for 6 oz.
- 4** Touch **Start/Enter**.

Chicken Chart

| Category | Touch Pad Number | Amount |
|-----------------|------------------|---------------|
| Chicken Wings | 1 | 6, 12 oz. |
| Chicken Nuggets | 2 | 4, 8 oz. |
| Spicy Chicken | 3 | 2, 4 servings |
| Mexican Chicken | 4 | 2, 4 servings |

When the cook time is over, four beeps will sound and **COOK END** will display.

NOTE: See recipes on page 19.

Popcorn

Use only with prepackaged microwave popcorn weighing 1.75 to 3.5 ounces.

NOTE: Do not use this feature twice in succession on the same food portion—it may result in severely overcooked or burnt food.

Popcorn (Do not use the rack when microwave cooking.)

Popcorn lets you pop 3.0 and 3.5 ounce bags of commercially packaged microwave popcorn. Pop only one package at a time. If you are using a microwave popcorn popper, follow manufacturer's instructions.

Touch the **Popcorn** pad. When the cook time is over, four beeps will sound and **COOK END** will display.

Recommended amounts: 3.0-3.5 oz.

To cook a snack size bag (1.75 oz.) place the bag in the oven. Set the oven to cook for 2 minutes at full power. LISTEN for the popping to slow down. When the popping slows to one pop per second, stop the oven. Make a note of how much time it took and use that setting in the future.

⚠ CAUTION:

DO NOT leave the microwave oven unattended while popping popcorn.

When popping commercially packaged popcorn, remove the rack from the oven. Do not place the bag of microwave popcorn on the rack or under the rack.

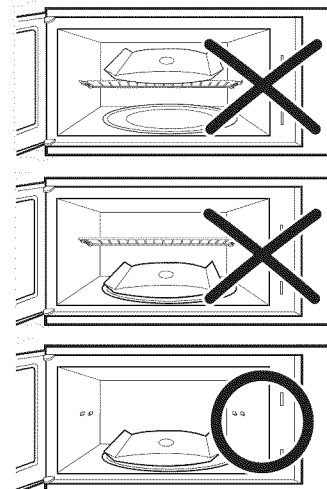

Soften

The oven uses low power to soften foods (butter, ice cream, cream cheese and frozen juice). See the Soften Chart.

Example (softening a quart of ice cream):

- 1** Touch **Soften**.
- 2** Choose the food category. Touch **2** for ice cream.
- 3** Choose the amount. Touch **2** for quart.
- 4** Touch **Start/Enter**.

Soften

2

2

Start
Enter

Soften Chart

| Category | Touch Pad Number | Amount |
|--------------|------------------|--------------------------|
| Butter | 1 | 1, 2, 3 sticks |
| Ice Cream | 2 | Pint, Quart, Half Gallon |
| Cream Cheese | 3 | 3, 8 oz. |
| Frozen Juice | 4 | 6, 12, 16 oz. |

When the heating time is over, four beeps will sound and **COOK END** will display.

Melt

The oven uses low power to melt foods (butter or margarine, chocolate, marshmallows or processed cheese food). See the Melt Chart.

Example (melting 8 oz. of chocolate):

- 1** Touch **Melt**.
- 2** Choose the food category. Touch **2** for chocolate.
- 3** Choose the amount. Touch **2** for 8 oz.
- 4** Touch **Start/Enter**.

Melt

2

2

Start
Enter

Melt Chart

| Category | Touch Pad Number | Amount |
|------------------|------------------|----------------|
| Butter/Margarine | 1 | 1, 2, 3 sticks |
| Chocolate | 2 | 4, 8 oz. |
| Cheese | 3 | 8, 16 oz. |
| Marshmallows | 4 | 5, 10 oz. |

When the heating time is over, four beeps will sound and **COOK END** will display.

About the sensor and auto microwave features.

Sensor Cook Chart

| Category | Direction | Amount |
|----------------------|---|---|
| Baked Potato | Pierce each potato with a fork and place on the oven tray around the edge, at least one inch apart. | 1-4 medium approx. 8-10 oz. each |
| VEGETABLE | Fresh Vegetables | Prepare as desired, wash and leave residual water on the vegetables. Place in an appropriately sized microwave container, cover with plastic wrap and vent. |
| | Frozen Vegetables | Remove from package, rinse off frost under running water. Place in an appropriately sized microwave container, cover with plastic wrap and vent. |
| | Canned Vegetables | Remove from the outer display can. Place in an appropriately sized microwave container, cover with plastic wrap and vent. After cooking, stir and allow to stand for 3 minutes. |
| Casserole | Assemble the ingredients per the recipe in a 1-2 quart casserole. Cook with plastic wrap and vent. After cooking, stir and allow to stand for 3 minutes | 1-4 cups |
| Rice | Add twice the amount of water as rice. Use a microwave container large enough to prevent water from boiling over dish. Cover with plastic wrap or lid. | 1/2-2 cups |
| Frozen Entrée | Remove from outer display package. Slit cover. If not in microwave-safe container, place on plate, cover with plastic wrap and vent. | 10-21 oz. |

Sensor Reheat Chart

| Category | Direction | Amount |
|---------------------|---|------------------------------|
| Pizza Slice | This is a reheat function for leftover pizza. Place on a paper towel on a microwave-safe plate. | 1-3 slices (3-5 oz. each) |
| Dinner Plate | Place on a low plate. Cover with vented plastic wrap. Let stand 3 minutes. | 1-2 servings |
| Soup/Sauce | Place in a shallow microwavable casserole. Cover with vented plastic wrap. After cooking, stir and let stand 3 minutes. | 1-4 cups |
| Casserole | Cover the dish containing the casserole with plastic wrap and vent. After cooking, stir and allow to stand for 3 minutes. | 1-4 cups |

Chicken Chart

| Category | Direction | Amount |
|---|--|-----------------|
| Chicken Wings (frozen, precooked) | Place in a single layer around the edge of a dinner plate or serving platter. | 6 or 12 oz. |
| Chicken Nuggets (frozen, precooked) | Place in a single layer around the edge of a dinner plate. | 4 or 8 oz. |
| Spicy Chicken | <p>- 2 servings (double the ingredients for 4 servings)</p> <p>1½ pounds skinless chicken pieces</p> <p>1 teaspoon cayenne pepper</p> <p>1½ tablespoon paprika</p> <p>1/2 teaspoon pepper</p> <p>1/2 cup hot sauce or 1 tablespoon Tabasco sauce</p> <p>1/2 cup barbecue sauce of choice</p> <p>Mix everything in an 8 X 8-inch glass dish or similar dish and cover with plastic wrap. Cook on Spicy chicken.</p> <p>Stir and serve as is or place under a broiler for a few minutes for additional browning.</p> | 2 or 4 servings |
| Mexican Chicken | <p>- 2 servings (double the ingredients for 4 servings)</p> <p>1/2 medium onion, chopped</p> <p>1/2 green bell pepper, diced</p> <p>1/2 cup frozen peas</p> <p>1/2 cup long grain rice</p> <p>1 cup water</p> <p>1/2 cup salsa</p> <p>1½ pounds skinless chicken pieces, legs, thighs, breasts, wings or combination of all</p> <p>1 teaspoon cumin</p> <p>Salt and pepper to taste</p> <p>1/2 cup green olives w/pimentos</p> <p>Place onions and peppers in an 8 X 8-inch glass dish or similar container and microwave for 3 minutes. Add peas, rice, water, salsa, chicken and cumin. Season with salt and pepper. Cover with plastic wrap and cook on Mexican chicken. Stir in the olives and serve as is or place under a broiler for a few minutes to add additional browning.</p> | 2 or 4 servings |

Safety Instructions

Operating Instructions

Care and Cleaning

Troubleshooting Tips

Consumer Support

About the auto microwave features.

Soften Chart

| <i>Category</i> | <i>Direction</i> | <i>Amount</i> |
|---------------------|---|--------------------------|
| Butter | Unwrap and place in a microwavable container. Butter will be at room temperature and ready for use in the recipe. | 1, 2 or 3 sticks |
| Ice Cream | Place the container in the oven. Ice cream will be soft enough to make scooping easier. | Pint, Quart, Half Gallon |
| Cream Cheese | Unwrap and place in a microwavable container. Cream cheese will be at room temperature and ready for use in the recipe. | 3 or 8 oz. |
| Frozen Juice | Remove the top. Place in the oven. Frozen juice will be soft enough to mix easily with water. | 6, 12 or 16 oz. |

Melt Chart

| <i>Category</i> | <i>Direction</i> | <i>Amount</i> |
|----------------------------|---|------------------|
| Butter or Margarine | Unwrap and place in a microwavable container. No need to cover the butter. Stir at the end of cooking to complete melting. | 1, 2 or 3 sticks |
| Chocolate | Chocolate chips or squares of baking chocolate may be used. Unwrap the squares and place in a microwavable container. Stir at the end of the cycle to complete melting. | 4 or 8 oz. |
| Cheese | Use processed cheese food only. Cut into cubes. Place in a single layer in a microwavable container. Stir at the end of cooking to complete melting. | 8 or 16 oz. |
| Marshmallows | Large or miniature marshmallows may be used. Place in a microwavable container. Stir at the end of the cycle to complete melting. | 5 or 10 oz. |

Auto Defrost

Four defrost choices are preset in the oven. The defrost feature provides you with the best defrosting method for frozen foods, because the oven automatically sets the defrosting times for each food item according to the weight you enter.

For added convenience, **Auto Defrost** includes a built-in tone mechanism that reminds you to check, turn over, separate or rearrange the food during the defrost cycle. Four different defrosting options are provided:

1. Meat
2. Poultry
3. Fish
4. Bread

After touching **Auto Defrost** once, select the food category. Available weight ranges for Meat, Poultry and Fish are 0.1 to 6.0 lbs. The available weight range for Bread is 0.1 to 1.0 lb.

Example (defrosting 1.2 lbs of meat):

- 1** Touch **Auto Defrost**.
- 2** Choose the food category.
- 3** Enter the weight.
- 4** Touch **Start/Enter**.

NOTE: After you touch **Start/Enter**, the display counts down the defrost time. The oven will beep once during the Defrost cycle. At this time, open the door and turn, separate, or rearrange the food as needed. Remove any portions that have thawed, then return frozen portions to the oven and touch **Start/Enter** to resume the defrost cycle. **The oven will not stop during the Beep unless the door is opened.**

For best results:

Remove fish, shellfish, meat and poultry from its original closed paper or plastic package (wrapper). Otherwise, the wrap will hold steam and juice close to the foods, which can cause the outer surface of the foods to cook.

Form the meat into the shape of a doughnut before freezing. When defrosting, scrape off thawed meat when the beep sounds and continue defrosting.

Place foods in a shallow glass baking dish or a on a microwave roasting rack to catch drippings.

Foods should still be somewhat icy in the center when removed from the oven.

Auto Defrost Chart

| Category | Food |
|----------------------------------|---|
| Meat 0.1 to 6.0 lbs | Beef Ground beef, Round steak, Cubes for stew, Tenderloin steak, Pot roast, Rib roast, Rump roast, Chuck roast, Hamburger patty Lamb Chops (1-inch thick), Rolled roast Pork Chops (1/2-inch thick), Hot dogs, Spareribs, Country-style ribs, Rolled roast, Sausage |
| Poultry 0.1 to 6.0 lbs | Poultry Whole (under 4 lbs), Cut up, Breasts (boneless) Cornish Hens Whole Turkey Breast (under 6 lbs) |
| Fish 0.1 to 6.0 lbs | Fish Fillets, Whole steaks Shellfish Crab meat, Lobster tails, Shrimp, Scallops |
| Bread 0.1 to 1.0 lbs | Muffins Roll Cake |

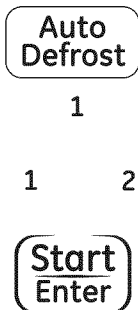

Quick Defrost

The **Quick Defrost** feature provides a rapid defrost for 1.0 pound frozen food. The oven automatically sets the defrosting time for ground beef.

Example (defrosting 1 lb. of ground beef):

- 1** Touch **Quick Defrost**.
- 2** Touch **Start/Enter**.

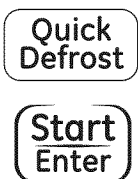

About the auto microwave features.

Time Defrost

This feature allows you to choose the time you want to defrost.

Example (defrosting for 2 minutes):



- 1** Touch **Time Defrost**.
- 2** Enter the defrosting time you want.
- 3** Touch **Start/Enter**. Defrost starts.

When the defrost time is over, four beeps will sound and **Cook End** will display.

Defrost Tips

When using **Auto Defrost**, the weight to be entered is the net weight in pounds and tenths of pounds (the weight of the food minus the container).

Use **Auto Defrost** only for raw food. **Auto Defrost** gives best results when food to be thawed is a minimum of 0°F (taken directly from a true freezer). If food has been stored in a refrigerator-freezer that does not maintain a temperature of 5°F or below, always program a lower food weight (for a shorter defrosting time) to prevent cooking the food.

If the food is stored outside the freezer for up to 20 minutes, enter a lower food weight.

The shape of the package alters the defrosting time. Shallow rectangular packets defrost more quickly than a deep block.

Separate pieces as they begin to defrost. Separated pieces defrost more easily.

You can use small pieces of aluminum foil to shield foods like chicken wings, leg tips and fish tails, but the foil must not touch the side of the oven. Foil causes arcing, which can damage the oven lining.

Shield areas of food with small pieces of foil if they start to become warm.

For better results, a preset standing time is included in the defrosting time.

For best results, elevate food to be defrosted on a microwave-safe roasting rack. This prevents the possibility of warm meat juices cooking food during defrost.

A DEFROST PLATE is provided for complete defrosting of larger food items. Place the defrost plate on the glass tray plastic side down. Place the item to be defrosted directly on the defrost plate.

Metal Rack

⚠ CAUTION:

To avoid risk of property damage:

Do not use rack to pop popcorn.

Rack must be on the four plastic supports when used.

Use the rack only when cooking food on rack position.

Do not cook with rack on floor of the oven.

The metal rack gives you extra space when cooking in more than one container at the same time.

To use rack:

- 1** Place the rack securely in the four plastic supports.
The rack **MUST NOT** touch metal walls or the back of the microwave oven.
- 2** Place equal amounts of food both **ABOVE AND BELOW** the rack.
The amount of food must be approximately the same to balance out cooking energy.

Microwave Utensil Guide

| Use | Do Not Use |
|--|--|
| <p>OVENPROOF GLASS: (treated for high intensity heat): Utility dishes, loaf dishes, pie plates, cake plates, liquid measuring cups, casseroles and bowls without metallic trim.</p> <p>CHINA: Bowls, cups, serving plates and platters without metallic trim.</p> <p>PLASTIC: Plastic wrap (as a cover)—lay the plastic wrap loosely over the dish and press it to the sides. Vent plastic wrap by turning back one edge slightly to allow excess steam to escape. The dish should be deep enough so that the plastic wrap will not touch the food. As the food heats, it may melt the plastic wrap wherever the wrap touches the food. Use plastic dishes, cups, semirigid freezer containers and plastic bags only for short cooking times. Use these with care because the plastic may soften from the heat of the food.</p> <p>PAPER: Paper towels, waxed paper, paper napkins and paper plates with no metallic trim or design. Look for the manufacturer’s label for use in the microwave oven.</p> | <p>METAL UTENSILS: Metal shields the food from microwave energy and produces uneven cooking. Also avoid metal skewers, thermometers or foil trays. Metal utensils can cause arcing, which can damage your microwave oven.</p> <p>METAL DECORATION: Metal-trimmed or metal-banded dinnerware, casserole dishes, etc. The metal trim interferes with normal cooking and may damage the oven.</p> <p>ALUMINUM FOIL: Avoid large sheets of aluminum foil because they hinder cooking and may cause harmful arcing. Use small pieces of foil to shield poultry legs and wings. Keep ALL aluminum foil at least 1 inch from the side walls and door of the oven.</p> <p>WOOD: Wooden bowls and boards will dry out and may split or crack when you use them in the microwave oven. Baskets react in the same way.</p> <p>TIGHTLY COVERED UTENSILS: Be sure to leave openings for steam to escape from covered utensils. Pierce plastic pouches of vegetables or other food items before cooking. Tightly closed pouches could explode.</p> <p>BROWN PAPER: Avoid using brown paper bags. They absorb too much heat and could burn.</p> <p>FLAWED OR CHIPPED UTENSILS: Any utensil that is cracked, flawed or chipped may break in the oven.</p> <p>METAL TWIST TIES: Remove metal twist ties from plastic or paper bags. They become hot and could cause a fire.</p> |

Do not use recycled paper products in the microwave oven. They may contain impurities that cause sparks to occur.

Cooking Guide.

Getting the Best Cooking Results

To get the best results from your microwave oven, read and follow the guidelines below:

Storage Temperature: Foods taken from the freezer or refrigerator take longer to cook than the same foods at room temperature.

The time for recipes in this book is based on the normal storage temperature of the food.

Size: Small pieces of food cook faster than large ones, pieces similar in size and shape cook more evenly. For even cooking, reduce the power when cooking large pieces of food.

Natural Moisture: Very moist foods cook more evenly because microwave energy is attracted to water molecules.

Stir foods such as casseroles and vegetables from the outside to the center to distribute the heat evenly and speed cooking. Constant stirring is not necessary.

Turn over foods like pork chops, baking potatoes, roasts or whole cauliflower halfway through the cooking time to expose all sides equally to microwave energy.

Fish and Shellfish

Cooking Fish and Shellfish:

General Directions

Prepare the fish for cooking.

- Completely defrost the fish or shellfish.
- Arrange unevenly shaped pieces with thicker parts toward the outside of the dish. Arrange shellfish in a single layer for even cooking.
- The type of cover you use depends on how you cook. Poached fish needs a microwavable lid or vented plastic wrap.

Place delicate areas of foods, such as asparagus tips, toward the center of the dish.

Arrange unevenly shaped foods, such as chicken pieces or salmon steaks, with the thicker, meatier parts toward the outside of the dish.

Shield, with **small** pieces of aluminum foil, parts of food that may cook quickly, such as wing tips and leg ends of poultry.

Let It Stand: After you remove the food from the microwave, cover food with foil or casserole lid and let it stand to finish cooking in the center and avoid overcooking the outer edges. The length of standing time depends on the density and surface area of the food.

Wrapping in waxed paper or paper towel:

Sandwiches and many other foods containing prebaked bread should be wrapped prior to microwaving to prevent drying out.

- Baked fish, coated fish or fish in sauce needs to be covered lightly with waxed paper to keep the coating crisp and sauce from getting watery.
- Always set the shortest cooking time. Fish is done when it turns opaque and the thickest part begins to flake. Shellfish is done when the shell turns from pink to red and the flesh is opaque and firm.

Fish and Shellfish Cooking Chart

| Fish | Power Level | Cooking Time | Directions |
|-----------------|-------------|---------------|--|
| Fish Fillets | HI | 3½–4½ minutes | Arrange fish in a single layer with thickest portion toward outside edge of 1½ quart microwavable baking dish. Brush with melted butter and season, if desired. Cook covered with vented plastic wrap. Let stand covered 2 minutes. If you are cooking more than 1 lb. of fish, turn the fish halfway through cooking. |
| Fish Steaks | HI | 4½–5½ minutes | |
| Whole Fish | 7 | 4½–6 minutes | |
| Scallops | HI | 3½–5 minutes | Arrange in a single layer. Prepare as directed above, except stir instead of turning the shellfish. |
| Shrimp, shelled | HI | 3½–5 minutes | |

Appetizers/sauces/soups

Cooking Appetizers: Tips and Techniques

Recommended

Crisp crackers, such as melba toast, shredded wheat and crisp rye crackers are best for microwave use. Wait until party time to add the spreads. Place a paper towel under the crackers while they cook in the microwave oven to absorb extra moisture.

Arrange individual appetizers in a circle for even cooking.

Stir dips to distribute heat and shorten cooking time.

Cooking Sauces: Tips and Techniques

Use a microwavable casserole or glass measuring cup that is at least 2 or 3 times the volume of the sauce.

Sauces made with cornstarch thicken more rapidly than those made with flour.

Cook sauces made with cornstarch or flour uncovered so you may stir them 2 or 3 times during cooking for a smooth consistency.

To adapt a conventional sauce or gravy recipe, reduce the amount of liquid slightly.

Meat

Cooking Meat: General Directions

Prepare the meat for cooking.

- Defrost completely.
- Trim off excess fat to avoid spattering.
- Place the meat, fat side down, on a microwavable rack in a microwavable dish.
- Use oven cooking bag for less tender cuts of meat.
- Arrange the meat so that thicker portions are toward the outside of the dish.
- Cover the meat with waxed paper to prevent spattering.

Tend the meat as it cooks.

- Drain juices as they accumulate to reduce spattering and keep from overcooking the bottom of the meat.
- Shield thin or bony portions with strips of foil to prevent overcooking.

NOTE: Keep the foil **at least 1 inch** from the oven walls, and do not cover more than one-third of the meat with foil at any one time.

Let the meat stand covered with foil 10–15 minutes after you remove it from the oven. The internal temperature of the meat may rise from 5–10° F during standing time.

The Meat Cooking Chart on the next page provides detailed directions, Power Level, and Cooking Time settings for most cuts of meat.

Cooking Soups: Tips and Techniques

Cook soups in a microwavable dish which holds double the volume of the recipe ingredients to prevent boil-over, especially if you use cream or milk in the soup.

Generally, cover microwaved soups with VENTED plastic wrap or a microwavable lid.

Cover foods to retain moisture. Uncover foods to retain crispness.

Avoid overcooking by using the minimum suggested time. Add more time, if necessary, only after checking the food.

Stirring occasionally will help blend flavors, distribute heat evenly, and may even shorten the cooking time.

When converting a conventional soup recipe to cook in the microwave oven, reduce the liquid, salt and strong seasonings.

Not Recommended

Appetizers with a crisp coating or puff pastry are best done in a conventional oven with dry heat.

Breaded products can be warmed in the microwave oven, but will not come out crisp.

Cooking Guide.

Meat Cooking Chart

| Meat | Power level | Cooking time | Directions |
|--|-------------|--|---|
| Beef Hamburgers Fresh or defrosted (4 oz. each) 1 patty 2 patties 4 patties | HI | 1-1½ minutes 1½-2 minutes 2½-3½ minutes | Form patties with a depression in the center of each. Place on a microwavable roasting rack. Brush with a browning agent, if desired. Cover with waxed paper. Turn over halfway through cooking. Let stand covered 1 minute. |
| Sirloin tip roast (3-4 lbs.) | 5 | 8-10 minutes per pound RARE (135°F) 11-13 minutes per pound MEDIUM (155°F) | Place the roast-fat side down on a microwavable roasting rack. Add desired seasonings and cover with waxed paper. Turn meat over halfway through cooking and shield if necessary. Remove the roast from the microwave oven when the desired temperature is reached. Let stand covered with the foil 15 minutes. (Temperature may rise about 10°F.) |
| Lamb Lamb roast, rolled boneless (3-4 lbs.) | 5 | 11-12 minutes per pound RARE (135°F) 12-13 minutes per pound MEDIUM (145°F) 13-14 minutes per pound WELL (155°F) | Place the roast fat-side down on a microwavable roasting rack. Brush lamb with marinade or desired seasonings such as rosemary, thyme or marjoram. Cover with waxed paper. Turn the roast over after 15 minutes, and again after 30 minutes. Shield if necessary. Remove the roast from the microwave when the desired temperature is reached. Let stand covered with foil 15 minutes. (Temperature may rise about 10°F.) |
| Pork Bacon slices 2 slices 4 slices 6 slices 10 slices | HI | 1½-2 minutes 2-3 minutes 4-5 minutes 7-8 minutes | Place bacon slices on a microwavable roasting rack. Cover with paper towels. After cooking, let stand 1 minute. |
| Chops (5-7 oz. each) 2 chops 4 chops | 3 | 18-20 minutes per pound 15-17 minutes per pound | Place chops in a microwavable baking dish. Add desired seasonings and cover with vented plastic wrap. Cook until no longer pink or until internal temperature reaches 170°F. Turn the chops over halfway through cooking. Let stand covered 5 minutes. (Temperature may rise about 10°F.) |
| Loin Roast, rolled, boneless (3½- 4½ lbs.) | 3 | 25-27 minutes per pound (165°F) | Place the roast in a cooking bag in a microwavable dish. Add seasonings and browning agent if desired. Close the bag loosely with microwavable closure or string. After cooking, let stand in bag 15 minutes. (Temperature may rise about 10°F.) The internal temperature of pork should reach 170°F before serving. |
| Sausage links, Fresh or Frozen, defrosted (1-2 oz. each) 2 links 4 links 6 links 10 links | HI | 45-60 seconds 1-1½ minutes 1½-2 minutes 1¾-2 minutes | Pierce the links and place on a microwavable roasting rack. Cover with waxed paper or paper towel. Turn over halfway through cooking. After cooking, let stand covered 1 minute. |

Chicken

Cooking Poultry: General Directions

- Prepare the poultry for cooking.
- Defrost completely.
 - Arrange poultry pieces with thicker pieces at the outside edge of the baking dish. When cooking legs, arrange them like the spokes of a wheel.
 - Cover the baking dish with waxed paper to reduce spattering.
 - Use a browning agent or cook with a sauce to give a browned appearance.

Watch the poultry as it cooks.

- Drain and discard juices as they accumulate.
- Shield thin or bony pieces with small strips of aluminum foil to prevent overcooking. Keep foil **at least 1 inch** from the oven walls and other pieces of foil.

Poultry is done when it is no longer pink and the juices run clear. When done, the temperature in the thigh meat should be 180-185°F.

Let the poultry stand after cooking covered with foil for 10 minutes.

The Poultry Cooking Chart below provides detailed directions, Power Level, and Cooking Time settings for most cuts and types of poultry.

Chicken Cooking Chart

| Chicken | Power level | Cooking time | Directions |
|---|-------------|-------------------------|---|
| Chicken pieces (2½-3 lbs.) | HI | 4½-5½ minutes per pound | Before cooking, wash pieces and shake the water off. Place pieces in a single layer in a microwavable baking dish with thicker pieces to the outside. Brush with butter or browning agent and seasonings if desired. Cover with waxed paper. Cook until no longer pink and juices run clear. Let stand covered 5 minutes. |
| Chicken whole (3-3½ lbs.) | HI | 12-13 minutes per pound | Before cooking, wash and shake off water. Place breast-side down on a microwavable roasting rack. Brush with butter or browning agent and seasoning if desired. Cover with waxed paper. Cook 1/3 of estimated time. Turn breast side up, brush with butter, or browning agent. Replace waxed paper. Cook 1/3 of estimated time again. Shield if necessary. Cook remaining 1/3 of estimated time or until no longer pink and juices run clear. Let stand covered with foil 10 minutes. (The temperature may rise about 10°F.) The temperature in the thigh should be 180°F-185°F when the poultry is done. |
| Cornish Hens whole (1-1½ lbs. each) | HI | 6-7 minutes per pound | Before cooking, wash and shake the water off. Tie wings to body of hen and the legs to tail. Place hens breast side down on a microwavable rack. Cover with waxed paper. Turn breast-side up halfway through cooking. Shield bone ends of drumsticks with foil. Remove and discard the drippings. Brush with butter or browning agent and seasonings if desired. Cook until no longer pink and juices run clear. Remove the hens from the microwave oven when they reach the desired temperature. Let stand covered with foil 5 minutes. (The temperature may rise about 10°F.) The temperature in the breast should be 170°F before serving. |

Cooking Guide.

Pasta and Rice

Microwave cooking and conventional cooking of pasta, rice and cereal require about the same amount of time; but, microwave cooking is a more convenient method because you can cook and serve in the same dish. There is no stirring needed and leftover pasta tastes just like fresh cooked when reheated in the microwave oven.

Cooking Pasta and Rice: Tips and Techniques

If you are planning to use rice or pasta in a casserole, undercook it so it is still firm. Allow for standing time with rice, but not for pasta.

The Pasta and Rice Cooking Charts below provide specific directions, with Power Level and cooking time settings for most common types of pasta and rice.

Pasta Cooking Chart

| Pasta | Power Level | Cooking Time | Directions |
|---|-------------|-------------------------------|---|
| Spaghetti 4 cups water Add 8 oz. spaghetti | HI 5 | 9-10 minutes 7½-8½ minutes | Combine hot tap water and salt, if desired. Use a 2-quart microwavable baking dish and cover with vented plastic wrap for spaghetti and lasagna noodles. Use microwavable lid or vented plastic wrap for macaroni and egg noodles. Cook as directed in the chart or until the water boils. Stir in the pasta; cook covered as directed in the chart or until tender. Drain in a colander. |
| Macaroni 3 cups water Add 2 cups macaroni | HI 5 | 6-7 minutes 5½-6½ minutes | |
| Lasagna noodles 4 cups water Add 8 oz. lasagna noodles | HI 5 | 7-8 minutes 11-12 minutes | |
| Egg noodles 6 cups water Add 4 cups noodles | HI 5 | 8-10 minutes 5½-6½ minutes | |

Rice Cooking Chart

| Rice | Power Level | Cooking Time | Directions |
|---|-------------|-----------------------------|--|
| Long grain 2¼ cups water Add 1 cup rice | HI 5 | 4½-5½ minutes 14 minutes | Combine hot tap water and salt, if desired, in 2 quart microwavable casserole. Cover with microwavable lid or vented plastic wrap. Cook as directed in the chart or until water boils. Stir in rice and any seasonings. Cook covered as directed in the chart or until water is absorbed and rice is tender. Let stand covered 5 to 10 minutes. Fluff with a fork. |
| Brown 2½ cups water Add 1 cup rice | HI 5 | 4½-5½ minutes 28 minutes | |
| Long grain and wild rice mix 2⅓ cups water Add 6 oz. package | HI 5 | 4-5 minutes 24 minutes | |
| Quick cooking 1 cup water Add 1 cup rice | HI | 2-3 minutes | Cook water until it boils. Stir rice into boiling water and let stand, covered 5 to 10 minutes or until water is absorbed and rice is tender. Fluff with a fork. |

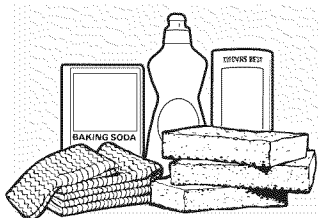

Helpful Hints

An occasional thorough wiping with a solution of baking soda and water keeps the inside fresh.

For best performance and safety, keep the oven clean inside and outside. Take special care to keep the inner door panel and the oven front frame free of food or grease build-up. **Never use rough powder or pads.** Wipe the microwave oven inside and out, including the hood bottom cover, with a soft cloth and a warm (not hot) mild detergent solution. Then rinse and wipe dry. Use a chrome cleaner and polish on chrome, metal and aluminum surfaces. Wipe spatters immediately with a wet paper towel, especially after cooking chicken or bacon. Clean your oven weekly or more often, if needed.

Be sure the power is off before cleaning any part of this oven.

How to Clean the Inside

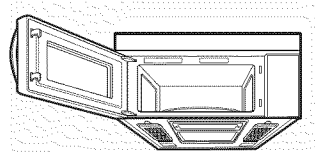

Walls, Floor, Inside Window, Metal and Plastic Parts on the Door

Some spatters can be removed with a paper towel; others may require a damp cloth. Remove greasy spatters with a sudsy cloth, then rinse with a damp cloth. Do not use abrasive cleaners or sharp utensils on oven walls.

Never use a commercial oven cleaner on any part of your microwave oven.

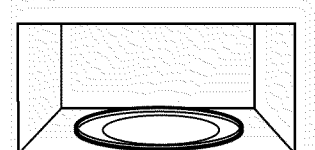

Removable Turntable and Turntable Support

To prevent breakage, do not place the turntable into water just after cooking. Wash it carefully in warm, sudsy water or in the dishwasher. The turntable and support can be broken if dropped. Remember, do not operate the oven in the microwave mode without the turntable and support seated and in place.

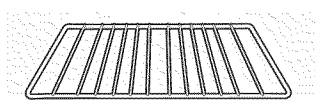

Rack

Clean with mild soap, water and a soft or nylon scrub brush or in the dishwasher. Dry completely. Do not use abrasive scrubbers or cleaners to clean the rack.

Do not clean in a self-cleaning oven.

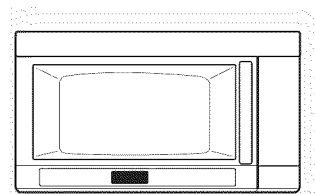

How to Clean the Outside

We recommend against using cleaners with ammonia or alcohol, as they can damage the appearance of the microwave oven. If you choose to use a common household cleaner, first apply the cleaner directly to a clean cloth, then wipe the soiled area.

Case

Clean the outside of the microwave oven with a sudsy cloth. Rinse and then dry. Wipe the window clean with a damp cloth.

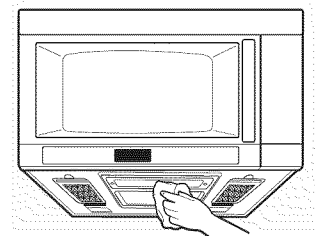

Control Panel

Wipe with a damp cloth. Dry thoroughly. Do not use cleaning sprays, large amounts of soap and water, abrasives or sharp objects on the panel—they can damage it. Some paper towels can also scratch the control panel.

Door Panel

Before cleaning the front door panel, make sure you know what type of panel you have. Refer to the eighth digit of the model number. "S" is stainless steel, "L" is CleanSteel and "B", "W" or "C" are plastic colors.

Stainless Steel

The stainless steel panel can be cleaned with Stainless Steel Magic or a similar product using a clean, soft cloth. Apply stainless cleaner carefully to avoid the surrounding plastic parts. Do not use appliance wax, polish, bleach or products containing chlorine on Stainless Steel finishes.

Care and cleaning of the oven.

CleanSteel

Use a clean, soft, light and lightly dampened cloth, then dry thoroughly. Do not use appliance wax, polish, bleach or products containing any chemical agent on the CleanSteel surfaces.

Plastic Color Panels

Use a clean, soft, lightly dampened cloth, then dry thoroughly.

Door Seal

It's important to keep the area clean where the door seals against the microwave. Use only mild, non-abrasive detergents applied with a clean sponge or soft cloth. Rinse well.

Bottom

Clean off the grease and dust on the bottom often. Use a solution of warm water and detergent.

Replacing the light bulbs.

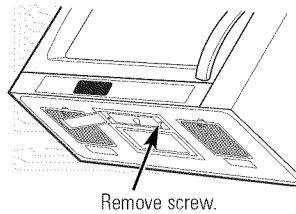

Cooktop Light/Nite Light

⚠ WARNING!

To avoid personal injury or property damage, wear gloves when replacing light bulb.

- 1 Unplug the oven or turn off power at the main power supply.
- 2 Remove the bulb cover mounting screws.

- 3 Replace bulb(s) with 20 watt appliance bulb(s).
- 4 Replace bulb cover and mounting screws.
- 5 Turn the power back on at the main power supply.

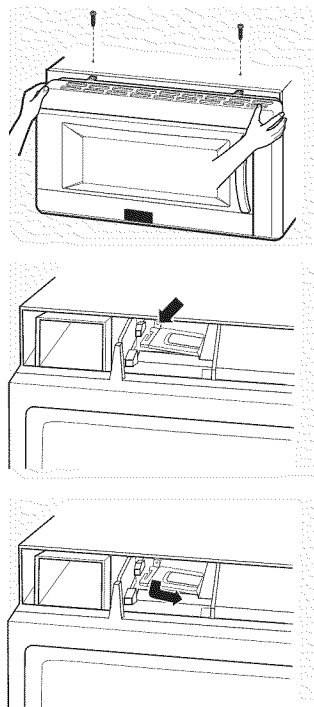

Oven Light

- 1 Unplug the oven or turn off power at the main power supply.
- 2 Remove the vent cover mounting screws (2 middle screws).
- 3 Tip the cover forward, then lift out to remove.
- 4 Lift up the bulb holder.

- 5 Replace bulb with a 30 or 40 watt appliance bulb.
- 6 Replace the bulb holder, if damaged.
- 7 Slide the bottom of the vent cover into place. Push the top until it snaps into place. Replace the mounting screws. Turn the power back on at the main power supply.

Charcoal filter (on some models)

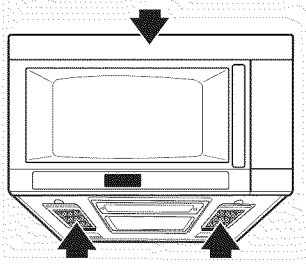

Reusable vent filters
(on all models)

Vent Fan

The vent fan has two metal reusable vent filters.

Models that recirculate air back into the room also use a charcoal filter.

Reusable Vent Filter

The metal filters trap grease released by foods on the cooktop. They also prevent flames from foods on the cooktop from damaging the inside of the oven.

For this reason, the filters must always be in place when the hood is used. The vent filters should be cleaned once a month, or as needed.

Removing and Cleaning the Grease Filters

The grease filters should be removed and cleaned often, at least once a month.

- 1** Disconnect power or unplug the microwave oven.
- 2** To remove the grease filters, slide the filters to the back. Pull the filters downward. The filters will drop out.
- 3** Soak the grease filters in hot water and a mild detergent. Scrub and swish to remove embedded dirt and grease. Rinse well and shake to dry. Do not clean filters with ammonia, corrosive cleaning agents such as lye-based oven cleaners, or place them in a dishwasher. The filters will turn black or could be damaged.

4 To reinstall the filters, slide them into the back slots, then push up to lock.

5 Reconnect power or plug in the microwave oven.

NOTE: Do not operate the hood without the filters in place.

To replace, slide the filters into the frame slots on the back of each opening. Press up and to the front to lock into place.

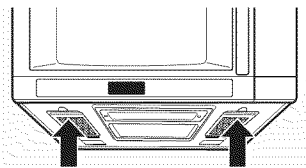
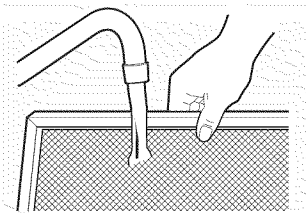
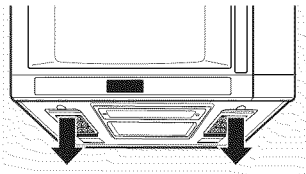

Care and cleaning of the oven.

Charcoal Filter

The charcoal filter cannot be cleaned. It must be replaced. Order Part No. WB02X10943 from your GE supplier.

If the model is not vented to the outside, the air will be recirculated through a disposable charcoal filter that helps remove smoke and odors.

The charcoal filter should be replaced when it is noticeably dirty or discolored (usually after 6 to 12 months, depending on usage). See "Optional Kits," page 7, for more information.

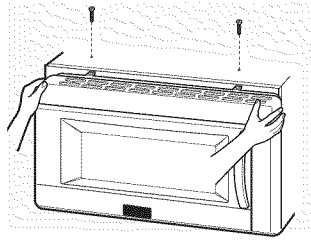

Remove 2 grille screws to remove the grille.

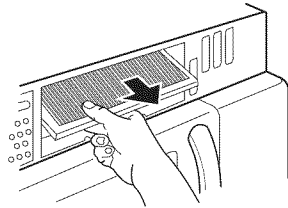
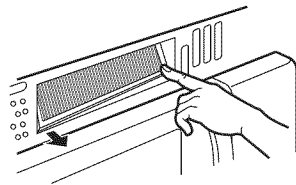

To Remove the Charcoal Filter

⚠ WARNING!

To avoid personal injury or property damage, do not operate oven hood without filters in place.

- 1** Unplug the oven or turn off power at the main power supply.
- 2** Remove the two vent grille mounting screws (2 middle screws).
- 3** Tip the grille forward, then lift out to remove.
- 4** Remove the old filter.

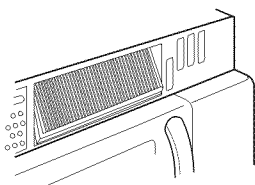

To Install the Charcoal Filter

⚠ WARNING!

To avoid personal injury or property damage, do not operate oven hood without filters in place.

- 1** Slide a new charcoal filter into place. The filter should rest at the angle shown.
- 2** Slide the bottom of the grille into place. Push the top until it snaps into place. Replace the mounting screws. Turn the power back on at the main power supply and set the clock.



Troubleshooting Tips
 Save time and money! Review the charts on the following pages first and you may not need to call for service.

| Problem | Possible Causes | What To Do |
|---|---|--|
| Oven will not start | A fuse in your home may be blown or the circuit breaker tripped. | • Replace fuse or reset circuit breaker. |
| | Power surge. | • Unplug the microwave oven, then plug it back in. |
| | Plug not fully inserted into wall outlet. | • Make sure the 3-prong plug on the oven is fully inserted into wall outlet. |
| | Door not securely closed. | • Open the door and close securely. |
| Control panel lighted, yet oven will not start | Door not securely closed. | • Open the door and close securely. |
| | Start/Enter pad not touched after entering cooking selection. | • Touch Start/Enter . |
| | Another selection entered already in oven and Clear/Off pad not touched to cancel it. | • Touch Clear/Off . |
| | Cooking time not entered after touching Time Cook . | • Make sure you have entered cooking time after touching Time Cook . |
| | Clear/Off was touched accidentally. | • Reset cooking program and touch Start/Enter . |
| | Food weight not entered after selecting Auto Defrost or Quick Defrost . | • Make sure you have entered food weight after selecting Auto Defrost or Quick Defrost . |
| CONTROL LOCKED appears on display | Food type not entered after touching Cook . | • Make sure you have entered a food type. |
| | The control has been locked. | • Touch and hold Clear/Off for about 3 seconds to unlock the control. |
| OVEN TOO HOT FOR SENSOR COOKING--- USING ALTERNATE METHOD appears on display | One of the sensor cooking pads was touched when the temperature inside the oven was greater than 200°F. | • These features will not operate when the oven is hot. The oven will automatically change to cook by time (follow the directions in the display) or once the oven is cool enough, the sensor features will function normally. |
| Floor of the oven is warm even when the oven has not been used | The cooktop light is located below the oven floor. When light is on, the heat it produces may make the oven floor get warm. | • This is normal. |
| You hear an unusual low-tone beep | You have tried to change the power level when it is not allowed. | • Many of the oven's features are preset and cannot be changed. |
| Oven interior light does not work | The light bulb is loose or defective. | • Tighten or change the light bulb. |
| Oven takes longer than normal to cook or cooks too rapidly | The Power Level is not programmed properly. | • Reset the Power Level. |

Before you call for service...



Troubleshooting Tips

| Problem | Possible Causes | What To Do |
|--|---|--|
| <i>Time of day clock does not always keep correct time</i> | The power cord is not fully inserted into the outlet receptacle. | • Fully insert the power cord. |
| | There is another appliance on the electrical circuit. | • Make sure the microwave oven has its own electrical circuit. |
| <i>Food cooks unevenly</i> | The food is not evenly shaped. | |
| | The food is not completely defrosted before cooking. | • Completely defrost the food. |
| | Check the placement of aluminum foil strips used to prevent overcooking. | |
| <i>Food is undercooked</i> | The recipe directions (amount, time and power levels) were not correctly followed. | • Check the recipe. |
| | The microwave oven is not on a separate circuit. | • Make sure the microwave oven has its own electrical circuit. |
| | The food is not completely defrosted before cooking. | • Completely defrost the food. |
| <i>Food is overcooked</i> | The recipe directions (amount, time, power levels and size of dish) were not correctly followed. | • Check the recipe. |
| <i>Arcing (sparks) occurs</i> | Microwavable dishes were not used. | • Use only microwavable dishes. |
| | Wire twist ties were used. | • Remove all wire twist ties. |
| | The oven was operated when empty. | • Make sure there is always food in the microwave oven when in use. |
| | If the metal rack was used, it was not properly installed on the four supports. | • Make sure the rack is properly seated on the four supports. |
| <i>Display shows a time counting down, but the oven is not cooking</i> | The door is not firmly closed. | • Push the door closed until it clicks. |
| | The timer was started instead of a cooking function. | • Reset the control to a cooking function. |
| <i>Vent fan comes on automatically</i> | The vent fan automatically turns on to protect the microwave oven if it senses too much heat rising from the cooktop below. | • This is normal. |
| <i>SENSOR ERROR appears on the display</i> | When using a Sensor feature, the door was opened before steam could be detected. | • Do not open door until steam is sensed and time is shown counting down on the display. |
| | Steam was not detected in a maximum amount of time. | • Use Time Cook to heat for more time. |

Things That Are Normal With Your Microwave Oven

Moisture on the oven door and walls while cooking. Wipe the moisture off with a paper towel or soft cloth.

Moisture between the oven door panels when cooking certain foods. Moisture should dissipate shortly after cooking is finished.

Steam or vapor escaping from around the door.

Light reflection around door or outer case.

Dimming oven light and change in the blower sound at power levels other than high.

Dull thumping sound while oven is operating.

The vent fan operating while the microwave oven is operating. The vent fan will not go off nor can it be turned off until the microwave oven is off.

TV-radio interference might be noticed while using the microwave oven. Similar to the interference caused by other small appliances, it does not indicate a problem with the microwave oven. Plug the microwave oven into a different electrical circuit, move the radio or TV as far away from the microwave oven as possible or check the position and signal of the TV/radio antenna.

Microwave terms.

| Term | Definition |
|----------------------|--|
| Arcing | <p>Arcing is the microwave term for sparks in the oven. Arcing is caused by:</p> <ul style="list-style-type: none"> the metal rack being installed incorrectly and touching the microwave walls. metal or foil touching the side of the oven. foil that is not molded to food (upturned edges act like antennas). metal such as twist-ties, poultry pins, gold-rimmed dishes. recycled paper towels containing small metal pieces. the turntable ring support being installed incorrectly. |
| Covering | Covers hold in moisture, allow for more even heating and reduce cooking time. Venting plastic wrap or covering with wax paper allows excess steam to escape. |
| Shielding | In a regular oven, you shield chicken breasts or baked foods to prevent over-browning. When microwaving, you use small strips of foil to shield thin parts, such as the tips of wings and legs on poultry, which would cook before larger parts. |
| Standing Time | When you cook with regular ovens, foods such as roasts or cakes are allowed to stand to finish cooking or to set. Standing time is especially important in microwave cooking. Note that a microwaved cake is not placed on a cooling rack. |
| Venting | After covering a dish with plastic wrap, you vent the plastic wrap by turning back one corner so excess steam can escape. |

| | | | | |
|-------------------------------------|--|-----------------------------------|--------------------------------------|----------------------------------|
| Safety Instructions | Operating Instructions | Care and Cleaning | Troubleshooting Tips | Consumer Support |
|-------------------------------------|--|-----------------------------------|--------------------------------------|----------------------------------|

| | | | | |
|-------------------------|-----------------------------|--------------------------|-------------------------------|----------------------------|
| Consumer Support | Troubleshooting Tips | Care and Cleaning | Operating Instructions | Safety Instructions |
|-------------------------|-----------------------------|--------------------------|-------------------------------|----------------------------|

Notes.

GE Microwave Oven Warranty.



All warranty service provided by our Factory Service Centers, or an authorized Customer Care® technician. To schedule service, visit us on-line at GEAppliances.com, or call 800.GE.CARES (800.432.2737). Please have serial and model numbers available when calling for service.

Staple your receipt here. Proof of the original purchase date is needed to obtain service under the warranty.

For The Period Of: GE Will Replace:

One Year
From the date of the original purchase

Any part of the microwave oven which fails due to a defect in materials or workmanship. During this **limited one-year warranty**, GE will also provide, **free of charge**, all labor and related service to replace the defective part.

Five Years
From the date of the original purchase

The magnetron tube, if the magnetron tube fails due to a defect in materials or workmanship. During this **five-year limited warranty**, you will be responsible for any labor or in-home service costs.

What GE Will Not Cover:

Service trips to your home to teach you how to use the product.

Improper installation, delivery or maintenance.

Product not accessible to provide required service.

Failure of the product or damage to the product if it is abused, misused (for example, cavity arcing from wire rack or metal/foil), or used for other than the intended purpose or used commercially.

Replacement of the cooktop light bulbs.

Replacement of house fuses or resetting of circuit breakers.

Damage to the product caused by accident, fire, floods or acts of God.

Incidental or consequential damage caused by possible defects with this appliance.

Damage caused after delivery.

EXCLUSION OF IMPLIED WARRANTIES—Your sole and exclusive remedy is product repair as provided in this Limited Warranty. Any implied warranties, including the implied warranties of merchantability or fitness for a particular purpose, are limited to one year or the shortest period allowed by law.

This warranty is extended to the original purchaser and any succeeding owner for products purchased for home use within the USA. If the product is located in an area where service by a GE Authorized Servicer is not available, you may be responsible for a trip charge or you may be required to bring the product to an Authorized GE Service Location for service. In Alaska, the warranty excludes the service calls to your home. Some states do not allow the exclusion or limitation of incidental or consequential damages. This warranty gives you specific legal rights, and you may also have other rights which vary from state to state. To know what your legal rights are, consult your local or state consumer affairs office or your state's Attorney General.

Warrantor: General Electric Company. Louisville, KY 40225

Safety Instructions

Operating Instructions

Care and Cleaning

Troubleshooting Tips

Consumer Support

Consumer Support.



GE Appliances Website

GEAppliances.com

Have a question or need assistance with your appliance? Try the GE Appliances Website 24 hours a day, any day of the year! For greater convenience and faster service, you can now download Owner's Manuals, order parts or even schedule service on-line.

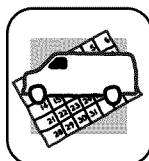

Schedule Service

GEAppliances.com

Expert GE repair service is only one step away from your door. Get on-line and schedule your service at your convenience any day of the year! Or call 800.GE.CARES (800.432.2737) during normal business hours.



Real Life Design Studio

GEAppliances.com

GE supports the Universal Design concept—products, services and environments that can be used by people of all ages, sizes and capabilities. We recognize the need to design for a wide range of physical and mental abilities and impairments. For details of GE's Universal Design applications, including kitchen design ideas for people with disabilities, check out our Website today. For the hearing impaired, please call 800.TDD.GEAC (800.833.4322).



Extended Warranties

GEAppliances.com

Purchase a GE extended warranty and learn about special discounts that are available while your warranty is still in effect. You can purchase it on-line anytime, or call 800.626.2224 during normal business hours. GE Consumer Home Services will still be there after your warranty expires.

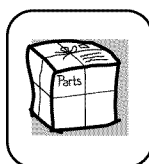

Parts and Accessories

GEAppliances.com

Individuals qualified to service their own appliances can have parts or accessories sent directly to their homes (VISA, MasterCard and Discover cards are accepted). Order on-line today, 24 hours every day or by phone at 800.626.2002 during normal business hours.

Instructions contained in this manual cover procedures to be performed by any user. Other servicing generally should be referred to qualified service personnel. Caution must be exercised, since improper servicing may cause unsafe operation.



Contact Us

GEAppliances.com

If you are not satisfied with the service you receive from GE, contact us on our Website with all the details including your phone number, or write to:

General Manager, Customer Relations
GE Appliances, Appliance Park
Louisville, KY 40225



Register Your Appliance

GEAppliances.com

Register your new appliance on-line—at your convenience! Timely product registration will allow for enhanced communication and prompt service under the terms of your warranty, should the need arise. You may also mail in the pre-printed registration card included in the packing material.