

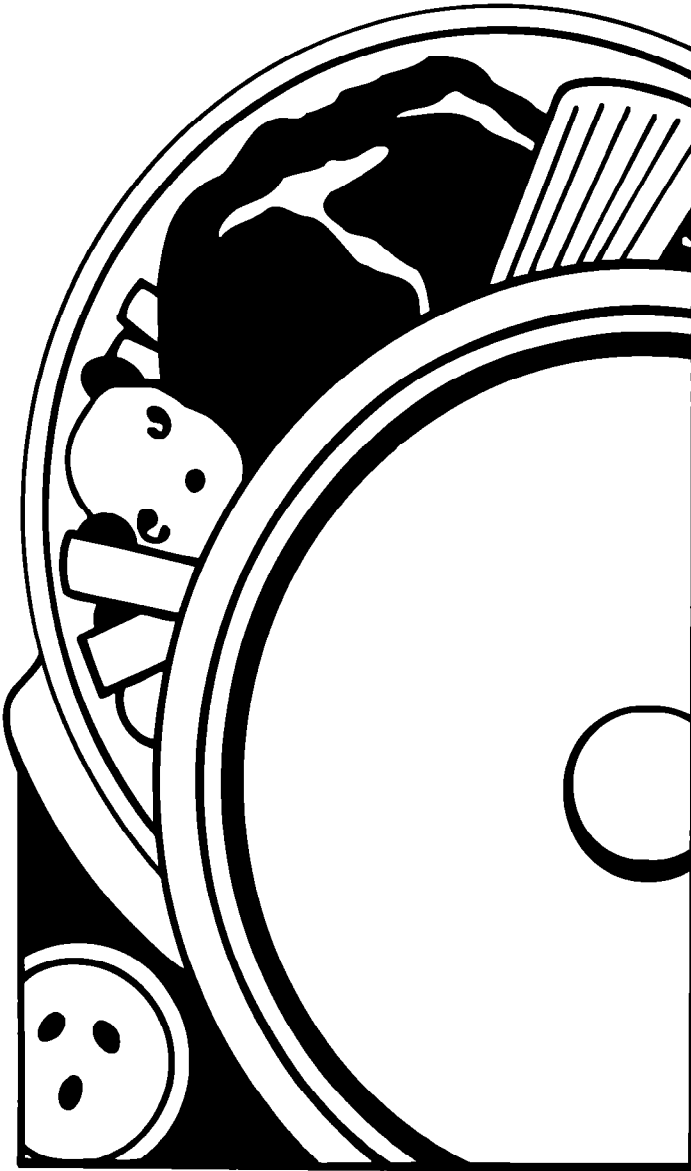

# Use And Care

## G U I D E



<b>A Note To You</b>	<b>2</b>
<b>Understanding Microwave Oven Safety</b>	<b>3</b>
<b>Installation Instructions</b>	<b>8</b>
<b>Getting To Know Your Microwave Oven</b>	<b>10</b>
<b>Using Your Microwave Oven</b>	<b>18</b>
<b>Caring For Your Microwave Oven</b>	<b>39</b>
<b>Cooking Guide</b>	<b>40</b>
<b>Questions And Answers</b>	<b>44</b>
<b>If You Need Assistance Or Service</b>	<b>45</b>
<b>Warranty</b>	<b>48</b>

**1-800-253-1301**  
Call us with questions or comments.

MICROWAVE OVEN

MODEL MT6125XBB/Q

12/94

# A Note To You

## **Thank you for buying a Whirlpool® appliance.**

You have purchased a quality, *world-class* home appliance. Years of engineering experience have gone into its manufacturing. To ensure that you will enjoy many years of trouble-free operation, we have developed this Use and Care Guide. It is full of valuable information on how to operate and maintain your appliance properly and safely. Please read it carefully. Also, please complete and mail the Ownership Registration Card provided with your appliance. This will help us notify you about any new information on your appliance.

## **Your safety is important to us.**

This guide contains safety symbols and statements. Please pay special attention to these symbols and follow any instructions given. Here is a brief explanation of the use of each symbol.

### **⚠ WARNING**

This symbol will help alert you to such dangers as personal injury, burns, fire and electrical shock.

### **⚠ CAUTION**

This symbol will help you avoid actions which could cause product damage (scratches, dents, etc.) and damage to your personal property.

## **Our Consumer Assistance Center number, 1-800-253-1301, is toll-free, 24 hours a day.**

If you ever have a question concerning your appliance's operation, or if you need service, first see "If You Need Assistance Or Service" on page 45. If you need further help, feel free to call our Consumer Assistance Center. When calling, you will need to know your appliance's complete model number and serial number. You can find this information on the model and serial number plate (see diagram on page 12). For your convenience, we have included a handy place below for you to record these numbers, the purchase date from the sales slip and your dealer's name and telephone number. Keep this book and the sales slip together in a safe place for future reference.

**Model Number** \_\_\_\_\_

**Dealer Name** \_\_\_\_\_

**Serial Number** \_\_\_\_\_

**Dealer Phone** \_\_\_\_\_

**Purchase Date** \_\_\_\_\_

# Understanding Microwave Oven Safety

## IMPORTANT SAFETY INSTRUCTIONS

Microwave ovens have been thoroughly tested for safe and efficient operation. However, as with any appliance, there are special installation and safety precautions which must be followed to ensure safe and satisfactory operation and prevent damage to the unit.

### **⚠ WARNING**

To reduce the risk of burns, fire, electrical shock, injury to persons, exposure to excessive microwave energy, or damage when using the microwave oven, follow basic precautions, including the following:

- Read all instructions before using the microwave oven.
- Read and follow the specific "PRECAUTIONS TO AVOID POSSIBLE EXPOSURE TO EXCESSIVE MICROWAVE ENERGY" found on page 5.
- This appliance must be grounded. Connect only to properly grounded outlet. See "GROUNDING INSTRUCTIONS" found on page 9.
- Install or locate this appliance only in accordance with the provided Installation Instructions found on page 8.
- Some products such as whole eggs in the shell and sealed containers—for example, closed glass jars—may explode and should not be heated in this oven.
- Do not heat, store or use flammable materials in or near the oven. Fumes can create a fire hazard or explosion.
- Use this appliance only for its intended use as described in this manual. Do not use corrosive chemicals or vapors in this appliance. This type of oven is specifically designed to heat or cook food. It is not designed for industrial or laboratory use.
- As with any appliance, close supervision is necessary when used by children.
- Do not operate this appliance if it has a damaged cord or plug, if it is not working properly, or if it has been damaged or dropped. Electrical shock, fire or other hazards may result.
- This appliance should be serviced only by qualified service personnel. Call an authorized Whirlpool® service company for examination, repair or adjustment.
- Do not cover or block any opening on the appliance. Fire may result.
- Do not store or use this appliance outdoors. Do not use this product near water—for example, near a kitchen sink, in a wet basement, or near a swimming pool, and the like.
- Do not immerse cord or plug in water.
- Keep cord away from heated surfaces.
- Do not let cord hang over edge of table or counter.
- See door surface and interior cleaning instructions on page 39.
- To reduce the risk of fire in the oven cavity:
  - Do not overcook food. Carefully attend appliance if paper, plastic, or other combustible materials are placed inside the oven to facilitate cooking. Paper can char or burn, and some plastics can melt if used when heating foods.
  - Do not deep fry in oven. Microwavable utensils are not suitable and it is difficult to maintain appropriate deep frying temperatures.

continued on next page

## UNDERSTANDING MICROWAVE OVEN SAFETY

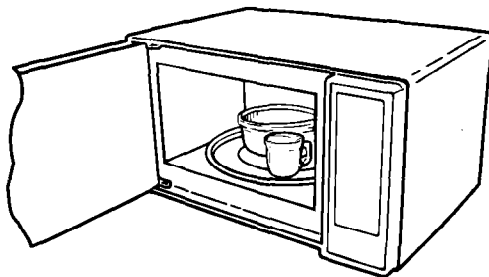

– **Test dinnerware or cookware before using.** To test a dish for safe use, put it into the oven with a cup of water beside it. Cook at 100% Cook Power for one minute. **If the dish gets hot and water stays cool, do not use it.**

Some dishes (melamine, some ceramic dinnerware, etc.) absorb microwave energy, becoming too hot to handle and slowing cooking times. Cooking in metal containers not designed for microwave use can damage the oven, as can containers with hidden metal (twist-ties, foil lining, staples, metallic glaze or trim).

– Remove wire twist-ties from paper or plastic bags before placing bag in oven.

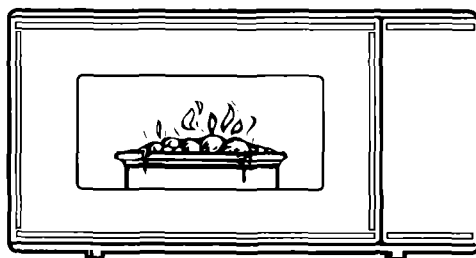

– If materials inside the oven should ignite, keep oven door closed, turn oven off, and disconnect the power cord or shut off power at the fuse or circuit breaker panel.

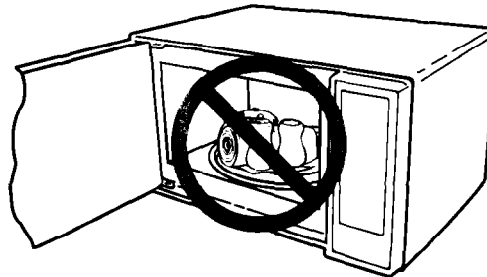

– Do not use the cavity for storage purposes. Do not leave paper products, cooking utensils, or food in the cavity when not in use.

– Do not mount over a sink.

– Do not store anything directly on top of the appliance when appliance is in operation.

• Read and follow “Operating safety precautions” starting on page 6.

1. A short power-supply cord is provided to reduce the risks resulting from becoming entangled in or tripping over a longer cord.
2. Longer cord sets or extension cords are available and may be used if care is exercised in their use.
3. If a long cord or extension cord is used temporarily, (a) the marked electrical rating of the cord set or extension cord should be at least as great as the electrical rating of the appliance, (b) the extension cord must be a grounding-type, 3-wire cord that has a 3-blade grounding plug and a 3-slot receptacle that will accept the plug on the appliance, and (c) the longer cord should be arranged so that it will not drape over the countertop or tabletop where it can be pulled on by children or tripped over accidentally.
4. A qualified electrician must install a properly grounded and polarized 3-prong receptacle near the appliance.

**– SAVE THESE INSTRUCTIONS –**

## **PRECAUTIONS TO AVOID POSSIBLE EXPOSURE TO EXCESSIVE MICROWAVE ENERGY...**

**Do not** attempt to operate this oven with the door open since open-door operation can result in harmful exposure to microwave energy. It is important not to defeat or tamper with the safety interlocks.

**Do not** place any object between the oven front face and the door or allow soil or cleaner residue to accumulate on sealing surfaces.

**Do not** operate the oven if it is damaged. It is particularly important that the oven door close properly and that there is no damage to the:

- (1) Door (bent),
- (2) Hinges and latches (broken or loosened),
- (3) Door seals and sealing surfaces.

**Do not** operate the microwave oven if the door window is broken.

The microwave oven should be checked for microwave leakage by qualified service personnel after a repair is made.

The oven should not be adjusted or repaired by anyone except properly qualified service personnel.

**Do not** operate the microwave oven with the outer cabinet removed.

## Operating safety precautions

### ⚠ WARNING

To reduce the risk of burns, fire, electrical shock, injury to persons, or damage when using the microwave oven, follow the precautions on pages 6-7.

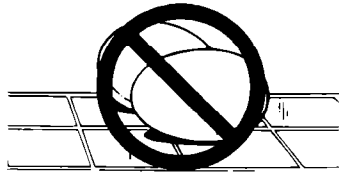

**Never cook or reheat a whole egg inside the shell.** Steam build-up in whole eggs may cause them to burst and burn you, and possibly damage the oven. **Slice** hard-boiled eggs before heating. In rare instances, poached eggs have been known to explode. **Cover** poached eggs and **allow** a standing time of one minute before cutting into them.



### Stir before heating

**For best results, stir any liquid several times before heating or reheating.** Liquids heated in certain containers (especially cylindrical containers) may become overheated. The liquid may splash out with a loud noise during or after heating or when adding ingredients (coffee, etc.) resulting in harm to the oven and possible personal injury.



**Never** lean on the door or allow a child to swing on it when the door is open. Injury could result.

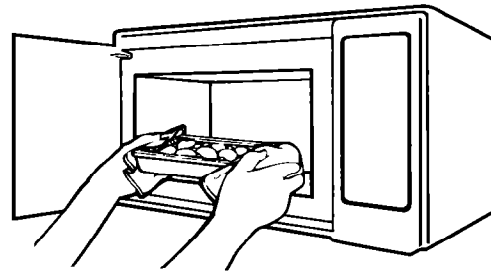

**Use hot pads.** Microwave energy does not heat containers, but the hot food does.

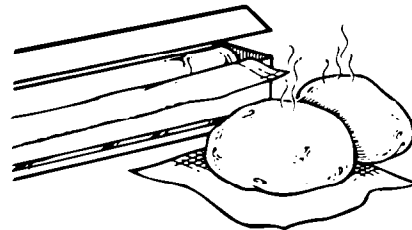

**Do not overcook potatoes.** Fire could result. At the end of the recommended cooking time, potatoes should be slightly firm because they will continue cooking during standing time. **After microwaving, wrap** potatoes in foil and **set aside** for 5 minutes. They will finish cooking while standing.

# UNDERSTANDING MICROWAVE OVEN SAFETY

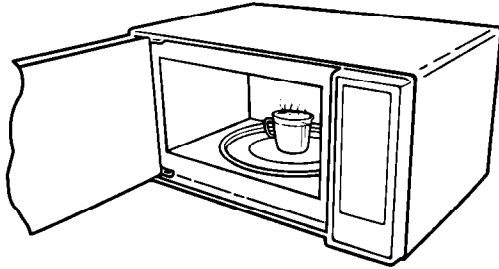

**Do not** start a microwave oven when it is empty. Product life may be shortened.

If you practice programming the oven, **put** a container of water in the oven.

It is normal for the oven door to look wavy after the oven has been running for a while.

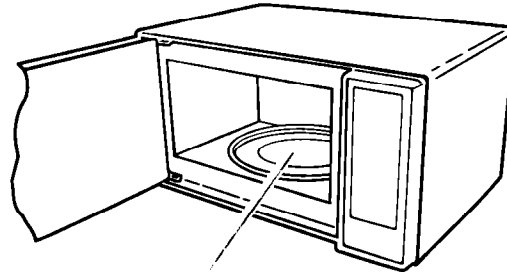

Glass turntable

**Do not** operate the microwave oven unless the glass turntable is securely in place and can rotate freely. The turntable can rotate in either direction.

**Make sure** support base is all the way on the shaft in oven cavity floor. **Make sure** support rollers are completely inside center circle of turntable for proper rotation.

**Make sure** the glass turntable is correct-side up in oven. **Carefully place** cookware on glass turntable to avoid possible breakage.

**Handle glass turntable with care** when removing from oven to avoid possible breakage. If glass turntable cracks or breaks, contact your Whirlpool dealer for a replacement.

When you use a browning dish, the browning dish bottom must be at least  $\frac{3}{16}$  inch above the glass turntable. Follow directions supplied with browning dish.

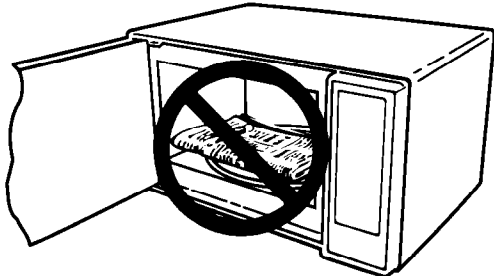

**Do not** use newspaper or other printed paper in the oven. Fire could result.

**Do not** dry flowers, fruit, herbs, wood, paper, gourds or clothes in the oven. Fire could result.

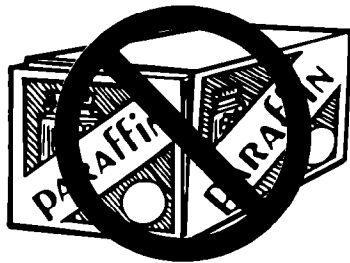

**Do not** try to melt paraffin wax in the oven. Paraffin wax will not melt in a microwave oven because it allows microwaves to pass through it.

## General information

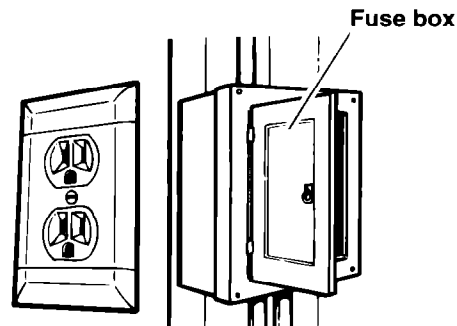

**If your electric power line or outlet voltage** is less than 110 volts, cooking times may be longer. Have a qualified electrician check your electrical system.

# Installation Instructions

Before you begin operating the oven, carefully read the following instructions.

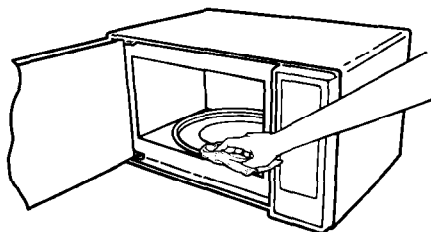

1. **Empty** the microwave oven and **clean** inside it with a soft, damp cloth. **Check** for damage such as misaligned door, damage around the door, or dents inside the oven or on the exterior. If there is any damage, do not operate the unit until it has been checked by an authorized Whirlpool® service technician and any repairs made.

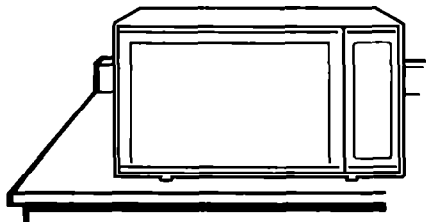

2. **Put** the oven on a cart, counter, table, or shelf that is strong enough to hold the oven and the food and utensils you put in it. **(The control side of the unit is the heavy side. Use care when handling.)** The weight of the oven is approximately 35 lbs (15.75 kg). The microwave oven should be at a temperature above 50°F (10°C) for proper operation.

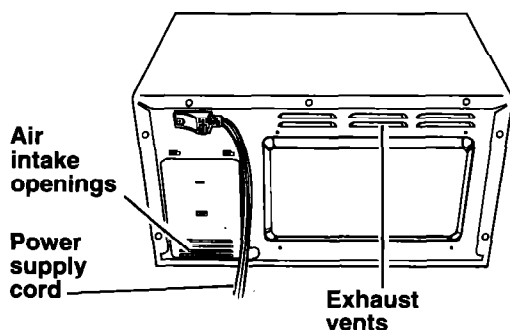

## **⚠ WARNING**

### **Fire, Electrical Shock, Excessive Exposure To Microwave Energy, Personal Injury and Product Damage Hazard**

- Do not block the rear air intake openings or exhaust vents. Allow a few inches of space at back of oven where intake opening and exhaust vents are located. Blocking the air intake openings and exhaust vents can cause damage to the oven and poor cooking results. Make sure the microwave oven legs are in place to ensure proper airflow.
- Do not install the oven next to or over a heat source (for example, a cooktop or range) without a UL approved trim kit or without being in a UL approved built-in configuration. Also, do not install oven in any area where excessive heat and steam are generated. This could cause a fire, electrical shock, excessive exposure to microwave energy, other personal injury or damage to the outside of the cabinet.

### **Built-in kits**

You can build in your microwave oven by using one of the trim kits listed on page 15. These kits are available from your Whirlpool Dealer. If your dealer does not stock the kit it can be ordered, by kit part number, by writing to:

Whirlpool Corporation  
 Attention: Customer Service Dept.  
 1900 Whirlpool Drive  
 LaPorte, IN 46350



## Electrical requirements

Observe all governing codes and ordinances. A 120 Volt, 60 Hz, AC only, 15 or 20 amp fused electrical supply is required.

(Time-delay fuse is recommended.) It is recommended that a separate circuit serving only this appliance be provided.

## GROUNDING INSTRUCTIONS

### **⚠ WARNING**

#### Electrical Shock Hazard

Improper use of the grounding plug can result in a risk of electrical shock. **DO NOT, UNDER ANY CIRCUMSTANCES, REMOVE THE POWER SUPPLY CORD GROUNDING PRONG.**

5. For your personal safety, this appliance must be grounded. In the event of an electrical short circuit, grounding reduces the risk of electrical shock by providing an escape wire for the electric current. This appliance is equipped with a polarized 3-prong grounding plug. It must be plugged into a correctly polarized mating 3-prong grounding type wall receptacle, properly installed and grounded in accordance with the National Electrical Code and local codes and ordinances. If a mating wall receptacle is not available or if you are not sure if the wall receptacle is properly grounded and polarized, have it checked by a qualified electrician.

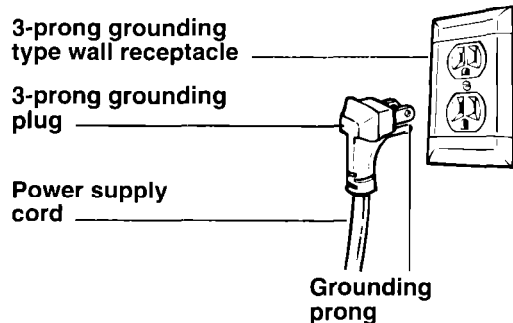

It is the personal responsibility and obligation of the customer to have a properly grounded and correctly polarized 3-prong wall receptacle installed by a qualified electrician.

Consult a qualified electrician if the grounding instructions are not completely understood, or if doubt exists as to whether the appliance is properly grounded.

**It is not recommended to use an extension cord with your microwave oven, but if you find it necessary to do so temporarily (until a properly grounded and polarized 3-prong receptacle is installed), use only a heavy duty, UL listed, 3-wire grounding type extension cord containing three 16-gauge (minimum) copper wires.** It must not be longer than 10 feet (cords longer than 10 feet may affect the cooking performance of your microwave oven). The plug on the extension cord must fit into a 3-prong grounding type wall receptacle (as shown on this page) and the receptacle end of the extension cord must accept the 3-prong grounding plug of the microwave oven.

6.  To test the oven, plug it into the proper electrical outlet. Put about one cup (250 mL) of cold water in a glass container in the oven. Close the door. Make sure it latches. Follow the directions on page 19 to set the oven to cook for 2 minutes. When the time is up, the water should be heated.

7. **This microwave oven is designed for use in the household only and must not be used for commercial purposes.**

**Do not** remove the door, control panel or cabinet at any time. The unit is equipped with high voltage and should be serviced by an authorized Whirlpool® service technician.

**- SAVE THESE INSTRUCTIONS -**

# Getting To Know Your Microwave Oven

This section discusses the concepts behind microwave cooking and introduces you to the basics you need to know to operate your microwave oven. Please read this information before use.

<b>In This Section</b>	
	Page
<i>How your microwave oven works ...</i>	10
<i>Microwave oven features .....</i>	12
<i>Control panel features .....</i>	13
<i>Built-in kits .....</i>	15
<i>Setting the clock .....</i>	16
<i>Using the Minute Timer .....</i>	17

## How your microwave oven works

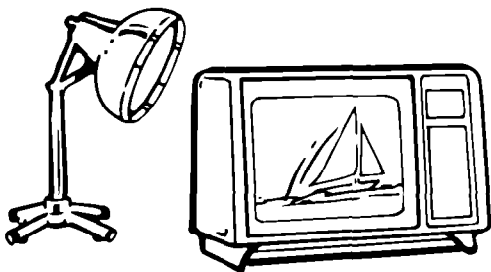

**Microwave ovens are safe.** Microwave energy is not hot. It causes food to make its own heat, and it's this heat that cooks the food.

Microwaves are like TV waves or light waves. You cannot see them, but you can see what they do.

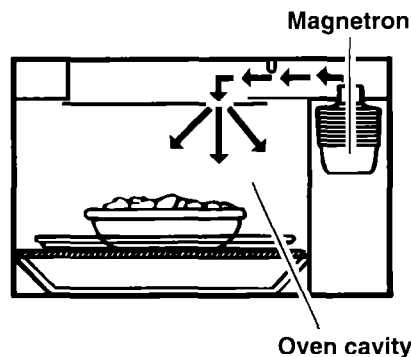

**A magnetron** in the microwave oven produces microwaves. The microwaves move into the oven where they contact food as it turns on the glass turntable.

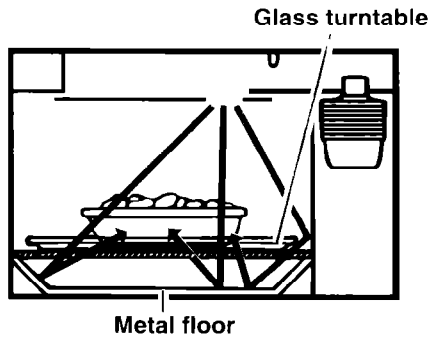

The glass turntable of your microwave oven lets microwaves pass through. Then they bounce off a metal floor, back through the glass turntable, and are absorbed by the food.

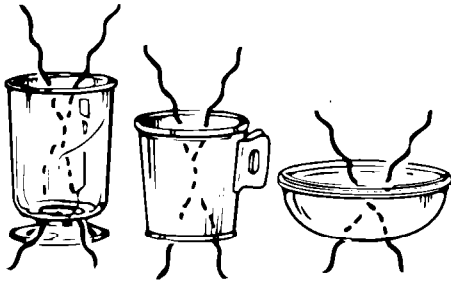

Microwaves pass through most glass, paper and plastics without heating them so food absorbs the energy. Microwaves bounce off metal pans so food does not absorb the energy.

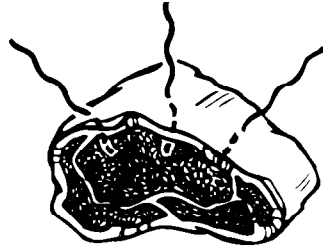

Microwaves may not reach the center of a roast. The heat spreads to the center from the outer, cooked areas just as in conventional cooking. This is one of the reasons for letting some foods (for example, roasts or baked potatoes) stand for a while after cooking, or for stirring some foods during the cooking time.

The microwaves disturb water molecules in the food. As the molecules bounce around bumping into each other, heat is made, like rubbing your hands together. This is the heat that does the cooking.

## Microwave oven features

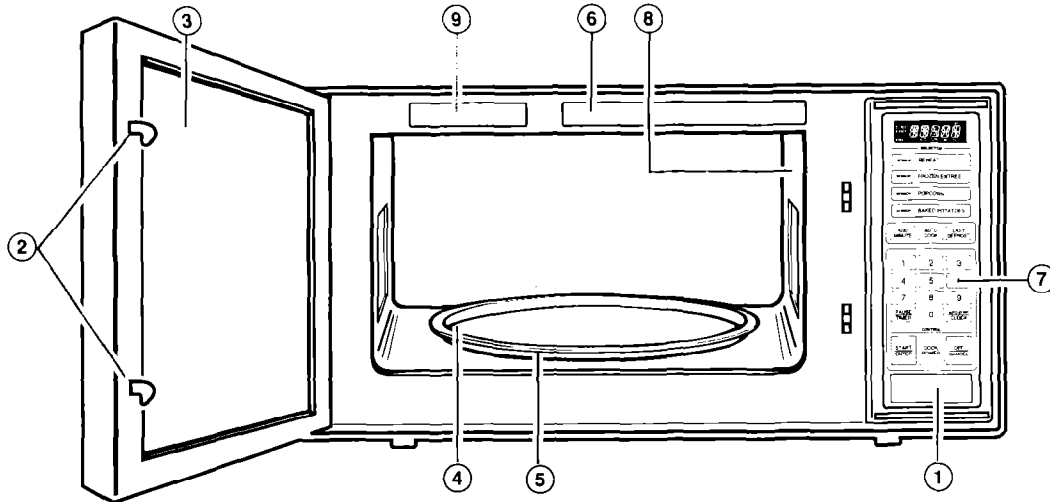

Your microwave oven is designed to make your cooking experience as enjoyable and productive as possible. To help get you up and running quickly, the following is a list of the oven's basic features:

1. **One-Touch Door Open Button.** Push to open door.
2. **Door Safety Lock System.** The oven will not operate unless the door is securely closed.
3. **Window with Metal Shield.** Shield prevents microwaves from escaping. It is designed as a screen to allow you to view food as it cooks.
4. **Glass Turntable.** This turntable turns food as it cooks for more even cooking. It must be in the oven during operation for best cooking results. See pages 7, 11 and 39 for more details.
5. **Removable Turntable Support** (under turntable).
6. **Cooking Guide Label.**
7. **Control Panel.** Touch pads on this panel to perform all functions. See pages 13, 14 and 15 for more information.
8. **Light.** Automatically turns on when door is opened or when oven is operating.
9. **Model and Serial Number Plate.**

**NOTE:** This microwave oven is available in both Designer Black™ and Designer White™ models.

## Control panel features

Your microwave oven control panel lets you select the desired cooking function quickly and easily. All you have to do is touch the necessary Command Pad. The following is a list of all the Command and Number Pads located on the control panel. For more information, see pages 16-38.

1. **Display.** This display includes a clock and indicators to tell you the time of day, cooking time settings and cooking functions selected.
2. **REHEAT.** Touch this pad to reheat food at a preprogrammed Cook Power until food is reheated. See page 32 for more information.
3. **FROZEN ENTREE.** Touch this pad to thaw and cook a frozen entree by touching just one pad. See page 33 for more information.
4. **POPCORN.** Touch this pad when popping popcorn in your microwave oven. The oven will cook at a preset Cook Power until the popcorn is popped. See page 30 for more information.
5. **BAKED POTATOES.** Touch this pad to bake potatoes. You do not need to calculate cooking time or Cook Power. See page 34 for more information.
6. **ADD MINUTE.** Touch this pad to cook for one minute at 100% Cook Power or to add an extra minute to your cooking cycle. See page 34 for more information.
7. **AUTO COOK.** Touch this pad to cook common microwave-prepared foods without needing to program times and Cook Powers. See page 22 for more information.
8. **EASY DEFROST.** Touch this pad to thaw frozen food by weight. See page 25 for more information.

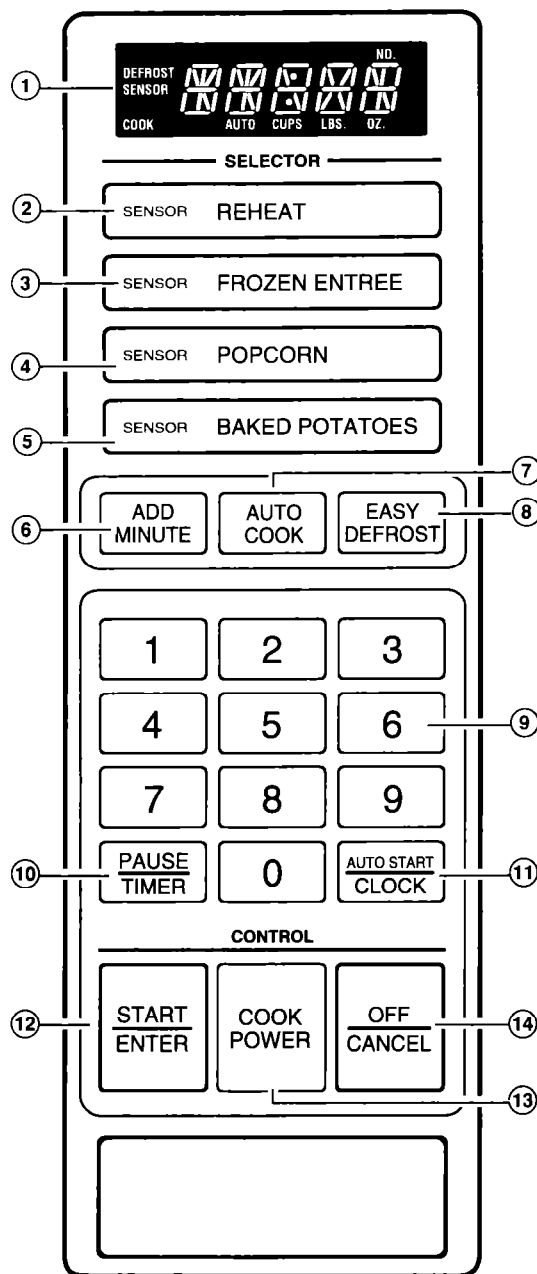

continued on next page

- 9 **Number Pads.** Touch Number Pads to enter cooking times, Cook Powers, quantities or weights.
10. **PAUSE/TIMER.** Touch this pad to set the Minute Timer or to stop the oven between cooking stages. See pages 17 and 36 for more information.
11. **AUTO START/CLOCK.** Touch this pad to enter the correct time of day or to program your oven to begin cooking automatically at a chosen time later in the day. See pages 16 and 37 for more information.
12. **START/ENTER.** Touch this pad to start a function. If you open the door after the oven begins to cook, retouch START/ENTER.
13. **COOK POWER.** Touch this pad followed by a Number Pad to set the amount of microwave energy released to cook the food. The higher the number, the higher the microwave power or “cooking speed”. See page 20 for more information. See the “Microwave cooking chart” on page 41 for specific Cook Powers to use for the foods you are cooking.
14. **OFF/CANCEL.** Touch this pad once to erase an incorrect command, cancel the Minute Timer or stop the oven temporarily during cooking. Touch it twice to cancel a program during cooking or to clear the Display.

#### NOTES:

- **If you touch** two Command Pads for the same cycle (for example, EASY DEFROST and AUTO COOK), the second command will cancel the first.
- **If you attempt** to enter unacceptable instructions, “ERROR” will appear in the Display. **Touch** OFF/CANCEL and **re-enter** the instructions.

## Audible signals

Audible signals are available to guide you when setting and using your oven:

- **A programming tone will sound** each time you touch a pad.
- **A single long tone** signals the end of a cooking cycle or Minute Timer function.
- **To cancel tones**, touch AUTO START/CLOCK followed by Number Pad 5 and START/ENTER. **To turn tones back on**, touch AUTO START/CLOCK followed by Number Pad 5 and OFF/CANCEL.

## Interrupting cooking

You can stop the oven during a cycle by opening the door. The oven stops heating and the fan stops, but the light stays on. **To restart cooking, close** the door and **touch**



If you do not want to continue cooking:

- **Close** the door and the light goes off.
- OR**
- **Touch**

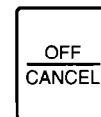

## Using the safety lock

The safety lock prevents unwanted operation of the microwave oven by small children.

### To lock or deactivate the control panel:

1. **Touch** AUTO START/CLOCK.
2. **Touch** Number Pad 1.
3. **Touch** START/ENTER.

“LOCK” will appear on the Display if a pad is touched.

### To cancel safety lock:

1. **Touch** AUTO START/CLOCK.
2. **Touch** Number Pad 1.
3. **Touch** OFF/CANCEL.

## Using the demonstration feature

You can program your microwave oven to display your commands as you enter them without turning the oven on. This feature helps you learn to use your oven without actually cooking food.

### To set the demo feature:

1. **Touch** AUTO START/CLOCK.
  2. **Touch** Number Pad 0.
  3. **Touch** START/ENTER.
- “DEMO” will appear on the Display.

### To cancel the demo feature:

1. **Touch** AUTO START/CLOCK.
2. **Touch** Number Pad 0.
3. **Touch** OFF/CANCEL.

---

## Built-in kits

You can build in your microwave oven by using one of the following trim kits:

SIZE	COLOR	KIT MODEL NO.	KIT PART NO.	FOR INSTALLATION OVER WHIRLPOOL OVEN MODEL
24"	Black	MK6124XAB	4319225	SB130PER, SB160PEX, RB160PXY, RB120PXY, RB100PXY, RB1005XY
27"	Black	MK6127XAB	4319227	SB130PER, SB160PEX, RB760PXY
30"	Black	MK6120XAB	4378060	RB260PXY, RB220PXY
24"	White	MK6124XAQ	4319224	Same as Kit No. 4319225
27"	White	MK6127XAQ	4319226	Same as Kit No. 4319227
30"	White	MK6120XAQ	4378059	Same as Kit No. 4378060

See page 8 for more information.

## Setting the clock

When you first plug in your microwave oven, the Display flashes "88:88". If the electric power ever goes off, the Display will again flash all 8's when the power comes back on.

### NOTES:

- **You can cook** without setting the clock, but the Display will not show the correct time of day after cooking.
- **To reset the clock**, touch AUTO START/CLOCK. A "0" will show on the Display. Continue to set the clock as shown below.
- **If you have touched in** an incorrect time, such as 12:65, "ERROR" will show on the Display. Touch OFF/CANCEL, then touch AUTO START/CLOCK and start over.

### To set time:

#### 1. Choose setting.

TOUCH



YOU SEE



TOUCH



YOU SEE



#### 2. Enter time of day.

Example for 3:25:

TOUCH



YOU SEE



#### 3. Complete entry.

TOUCH



YOU SEE

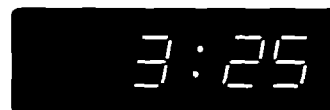



## Using the Minute Timer

Your microwave oven can be used as a kitchen timer. Use the Minute Timer for timing up to 99 minutes, 99 seconds.

### NOTES:

- **To see** the time of day while the Minute Timer is counting down, touch AUTO START/CLOCK.
- **If you want to use** other Command Pads while the Minute Timer is counting down, touch OFF/CANCEL to cancel the Minute Timer.

### 1. Enter time to be counted down.

Example for 3 minutes:

TOUCH

3

0

0

YOU SEE

### 2. Start countdown.

TOUCH

PAUSE  
TIMER

YOU SEE

(display counts down set time)

**When the set time ends**, a long tone will sound. When you open the door or touch OFF/CANCEL, you will see the time of day.

YOU SEE

# Using Your Microwave Oven

This section gives you instructions for operating each function. Please read these instructions carefully.

<b>In This Section</b>		<b>Page</b>	<b>Page</b>
To get the best cooking results .....	18	Using POPCORN .....	30
Cooking at high cook power .....	19	Using REHEAT .....	32
Cooking at lower cook powers .....	20	Using FROZEN ENTREE .....	33
Using AUTO COOK .....	22	Using BAKED POTATOES .....	34
Auto cook chart .....	23	Using ADD MINUTE .....	34
Using EASY DEFROST .....	25	Adding or subtracting cook time ....	35
Defrost chart .....	27	Using PAUSE .....	36
Defrosting tips .....	28	Using AUTO START .....	37
Cooking with more than one cook cycle .....	28		

## To get the best cooking results:

- **Although a new rating method\*** rates this oven at 900 watts, you may use a reliable cookbook and recipes developed for microwave ovens previously rated at 700-800 watts.
- **ALWAYS cook** food for the minimum recommended cooking time. If necessary, touch ADD MINUTE while the oven is operating or after it has completed the cooking cycle (see page 35 for more information). Then check for doneness to avoid overcooking the food.
- **Stir, turn over or rearrange** the food being cooked about halfway through the cooking time for most even doneness with all recipes.
- **If a glass cover is not available, use wax paper, paper towels or microwave-approved plastic wrap. Turn back** a corner to vent steam during cooking.

\*IEC-705 Test Procedure. The IEC-705 Test Procedure is an internationally recognized method of rating microwave wattage output and does not represent an actual change to output power or cooking performance.

## Cooking at high cook power

1. Put food in oven and close door.

2. Set cooking time.

Example for 1 minute, 30 seconds:

TOUCH

1

3

0

YOU SEE

A digital display showing the time 1:30 in a simple, segmented font.

3. Start oven.

TOUCH

START  
ENTER

YOU SEE

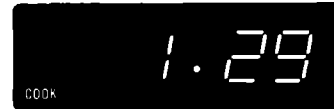
A digital display showing the time 1:29. The word "COOK" is visible in the bottom left corner of the display area.

(display counts down cooking time)

When the cooking time ends, a long tone will sound. When you open the door or touch OFF/CANCEL, you will see the time of day.

YOU SEE

A digital display showing the word "END" in a large, stylized, segmented font.

## **Cooking at lower cook powers**

For best results, some recipes call for lower Cook Powers. The lower the Cook Power, the slower the cooking. Each Number Pad also stands for a different percentage of Cook Power. Many microwave cookbook recipes tell you by number, percent or name which Cook Power to use.

The following chart gives the percentage of Cook Power each Number Pad stands for, and the Cook Power name usually used. It also tells you when to use each Cook Power:

<b>COOK POWER</b>	<b>WHEN TO USE IT</b>
Automatic 100% of full power HIGH	Quick reheating of foods with high water content, such as beverages. If food contains eggs or cream, choose a lower power.
9=90% of full power	Heating large quantities of liquids, such as water or soup stock.
8=80% of full power	Reheating soups or casseroles.
7=70% of full power MED-HIGH	Cooking and heating vegetables, fish, meat, etc. when you need a Cook Power lower than HIGH or when food is cooking too fast.
6=60% of full power	Cooking requiring special care, such as for high protein sauces, cheese and egg dishes, and casseroles that need to finish cooking.
5=50% of full power MED	Starting cakes which must be finished on HIGH power or finishing cooking of a large roast.
4=40% of full power	Simmering stews, reheating pastry.
3=30% of full power MED-LOW, DEFROST	Defrosting of foods such as bread, shellfish, and precooked foods.
2=20% of full power	Defrosting and softening butter, cheese and ice cream.
1=10% of full power LOW	Keeping one food serving warm.

**NOTE:** To check the Cook Power you set after cooking has started, touch COOK POWER. When you lift up on COOK POWER, the remainder of the cooking time will reappear on the Display.

---

## 1. Put food in oven and close door.

---

## 2. Set cooking time.

Example for 7 minutes, 30 seconds:

TOUCH

7

3

0

YOU SEE



---

## 3. Set Cook Power.

TOUCH

COOK  
POWER

YOU SEE



Example for 50% Cook Power:

TOUCH

5

YOU SEE



---

## 4. Start oven.

TOUCH

START  
ENTER

YOU SEE

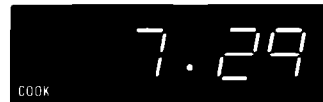

(display counts down  
cooking time)

---

When the cooking time ends, a long tone will sound. When you open the door or touch OFF/CANCEL, you will see the time of day.

YOU SEE



## Using AUTO COOK

Cooking with AUTO COOK lets you cook common microwave-prepared foods without needing to program times and Cook Powers. AUTO COOK has preset times and Cook Powers for eight major food categories: Frozen Vegetables, Rice, Ground Meat,

Fish Fillets, Turkey Breast, Roast Pork, Fresh Roll/Muffin, and Frozen Roll/Muffin. All you do is touch the Number Pad assigned to the desired category and enter the number of items being heated. Your microwave oven does the rest.

### 1. Put food in oven and close door.

### 2. Choose AUTO COOK.

TOUCH



YOU SEE



### 3. Choose setting.

Touch any of Number Pads 1-6.

**NOTE:** See "Auto cook chart" on pages 23 and 24 or the Cook Guide Label on the frame behind the door for food categories available.

Example for Setting 1 (Frozen Vegetables):

TOUCH



YOU SEE



### 4. Enter amount of items to be heated.

Example for two cups:

TOUCH



YOU SEE



### 5. Start oven.

TOUCH



YOU SEE



(display counts down cooking time)

6. When the cooking time ends, a long tone will sound and the oven will stop.

YOU SEE



(example)

Open door.

OR TOUCH



YOU SEE



(time of day)

## Auto cook chart

SETTING	FOOD	AMOUNT	PROCEDURE															
1	Frozen Vegetables	1-6 cups	<p>Cover with lid or plastic wrap. Let stand 3 minutes, covered.</p> <p><b>Note:</b> To select an amount when cooking a 10 oz package of frozen vegetables (this equals about 1½ cups), touch "1" for 1 cup of "tender crisp" vegetables (you cannot enter ½ cup amounts) or touch "2" for two cups of vegetables more fully cooked.</p>															
2	Rice	½-2 cups	<p>Place rice and water into a deep casserole. Cover with lid or plastic wrap. For each quantity of uncooked rice, touch the pads indicated.</p> <table border="1" style="width: 100%; border-collapse: collapse; margin: 10px 0;"> <tr> <td style="padding: 5px;">Uncooked Rice-cups</td> <td style="padding: 5px; text-align: center;">½</td> <td style="padding: 5px; text-align: center;">1</td> <td style="padding: 5px; text-align: center;">1½</td> <td style="padding: 5px; text-align: center;">2</td> </tr> <tr> <td style="padding: 5px;">Water-cups</td> <td style="padding: 5px; text-align: center;">1</td> <td style="padding: 5px; text-align: center;">2</td> <td style="padding: 5px; text-align: center;">3</td> <td style="padding: 5px; text-align: center;">4</td> </tr> <tr> <td style="padding: 5px;">Touch pads</td> <td style="padding: 5px; text-align: center;">5</td> <td style="padding: 5px; text-align: center;">1 0</td> <td style="padding: 5px; text-align: center;">1 5</td> <td style="padding: 5px; text-align: center;">2 0</td> </tr> </table> <p>After cooking, stir, cover and let stand 3-5 minutes or until all liquid has been absorbed.</p>	Uncooked Rice-cups	½	1	1½	2	Water-cups	1	2	3	4	Touch pads	5	1 0	1 5	2 0
Uncooked Rice-cups	½	1	1½	2														
Water-cups	1	2	3	4														
Touch pads	5	1 0	1 5	2 0														

continued on next page

## USING YOUR MICROWAVE OVEN

SETTING	FOOD	AMOUNT	PROCEDURE
3	<b>Ground Meat</b>	0.3-2.0 lbs	Use this pad to cook ground beef or turkey as patties or in a casserole to be added to other ingredients. Place patties on a microwave-safe rack and cover with wax paper. Place ground meat in a casserole and cover with wax paper or plastic wrap. When oven stops and "TURN OVER" is displayed, turn patties over or stir meat in casserole to break large pieces. Re-cover and touch START/ENTER. After cooking, let stand, covered, for 2-3 minutes.
4	<b>Fish Fillets</b>	0.5-2.0 lbs	Use this pad for fresh or defrosted fish fillets. Arrange in a pie plate or shallow casserole in a single layer. Tuck thin ends under to prevent overcooking. Cover with vented plastic wrap. After cooking, let stand, covered, for 1-3 minutes.
5	<b>Turkey Breast</b>	3.0-6.0 lbs	Wash. Place in baking dish. Cover with wax paper or plastic wrap.
6	<b>Roast Pork</b>	2.0-3.5 lbs	Place in microwave-proof and heat-proof baking dish. Let stand 10 minutes after cooking (covered).
7	<b>Fresh Roll/ Muffin</b>	1-6	Arrange on a double layer of paper towels. Cover with another towel.
8	<b>Frozen Roll/ Muffin</b>	1-6	Arrange on a double layer of paper towels. Cover with another towel.

**NOTE:** If you enter an amount not shown in the chart above, "ERROR" will appear. AUTO COOK will only operate with the amounts shown.



## Using EASY DEFROST

Your microwave oven automatically defrosts a variety of common meats at preset Cook Powers for preset times. The 3-stage Easy Defrost Cycle defrosts roast beef, pork, steaks, chops, fish, ground meat, and chicken. All you do is touch EASY DEFROST to enter the weight of the items being defrosted. Your microwave oven does the rest.

### NOTES:

- If you want to **change** the defrost time after choosing EASY DEFROST, see "Adding or subtracting cook time" on page 35.
- If **"ERROR"** appears on the Display, touch OFF/CANCEL and start over.

### 1. Put frozen food in oven and close door.

### 2. Choose EASY DEFROST.

TOUCH



YOU SEE



### 3. Enter food weight.

Each time you touch EASY DEFROST, the displayed food weight will increase by .5 pounds.

**NOTE:** When increasing the food weight, you must touch EASY DEFROST within two seconds after the last time you touched the pad. After two seconds, defrosting will start for the last food weight entered.

After two seconds:

TOUCH



a second time

YOU SEE



YOU SEE



(example: display counts down defrosting time in first stage)

### 4. After first stage is over, oven will stop and four tones will sound. Open door, turn over meat and shield any warm portions.

YOU SEE



# USING YOUR MICROWAVE OVEN

5. Close door.

YOU SEE

PRESS START

6. Restart oven.

TOUCH



YOU SEE

DEFROST  
2.40  
COOK

(example: display counts down second stage of defrost cycle)

7. After second stage is over, oven will stop and four tones will sound.  
Open door and check meat.

YOU SEE

CHEK

8. Close door.

YOU SEE

PRESS START

9. Restart oven.

TOUCH



YOU SEE

DEFROST  
1.30  
COOK

(example: display counts down third stage of defrost cycle)

10. After defrosting, oven will stop and one long tone will sound.

YOU SEE

COVER STAND

Open door.

OR TOUCH



YOU SEE

12:00

(time of day)

**Defrost chart**

FOOD	PROCEDURE
<b>Roast Beef, Pork</b>	Start with fat side down. After 1st stage, turn over and shield any warm portions with aluminum foil. After the 2nd stage, turn over and shield any warm portions with aluminum foil. Stand, covered 30-60 minutes.
<b>Steaks, Chops, Fish</b>	After the 1st stage, turn over and shield any warm portions with aluminum foil. After the 2nd stage, shield any warm portions with aluminum foil. Remove any pieces that are nearly defrosted. Stand, 10-20 minutes.
<b>Ground Meat</b>	Remove any thawed parts after each stage. Stand, 5-10 minutes.
<b>Chicken, Whole</b>	Remove giblets before freezing poultry for more uniform defrosting. Start with breast side down. After the 1st stage, turn over and shield any warm portions with aluminum foil. After the 2nd stage, shield any warm portions with aluminum foil. Stand, covered 30-60 minutes.
<b>Chicken Pieces</b>	After the 1st stage, turn over and rearrange. After the 2nd stage, if there are warm or thawed portions, rearrange or remove. Stand, 10-20 minutes.

## Defrosting tips

- **When using EASY DEFROST**, the weight to be entered is the net weight (the weight of the food minus the container). Enter weight to the nearest ½ lb.
- **Only use EASY DEFROST** for raw food. EASY DEFROST gives best results when food to be thawed is a minimum of 0°F (taken directly from a “true” freezer). If food has been stored in a refrigerator-freezer that does not maintain a temperature of 0°F or below, always program a lower food weight (for a shorter defrosting time) to prevent cooking the food.
- **If the food is stored outside** the freezer for up to 20 minutes, enter a lower food weight.
- **If the food is stored outside** the freezer for more than 20 minutes, and for defrosting ready-made food, defrost by time and power and let stand after defrosting.
- **The shape of the package** alters the defrosting time. Shallow rectangular packets defrost more quickly than a deep block.
- **Separate pieces** as they begin to defrost. Separated pieces defrost more easily.
- **You can use small pieces** of aluminum foil to shield foods like chicken wings, leg tips, and fish tails, but the foil must not touch the side of the oven. Foil can damage the oven lining.
- **Shield areas of food** with small pieces of foil if they start to become warm.
- **For better results, a preset standing time** is included in the defrosting time. This may make the defrosting time seem longer than expected. (For more information on standing time, see “Cooking tips” on page 42.)

## Cooking with more than one cook cycle

For best results, some recipes call for one Cook Power for a certain length of time, and another Cook Power for another length of time. Your oven can be set to change from one to another automatically.

### 1. Put food in oven and close door.

### 2. Set cooking time for first cycle.

Example for 7 minutes, 30 seconds:

TOUCH

7

3

0

YOU SEE

7 30

### 3. Set Cook Power for first cycle.

If you want to cook at full (100%) power, touch COOK POWER twice.

TOUCH

COOK  
POWER

twice

YOU SEE

P- HI

# USING YOUR MICROWAVE OVEN

If you want to cook at another Cook Power, touch COOK POWER followed by a Number Pad.

TOUCH



YOU SEE



Example for 50% Cook Power:

TOUCH



YOU SEE

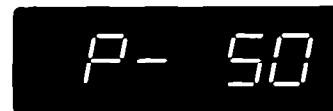

## 4. Set cooking time for second cycle.

Example for 3 minutes, 25 seconds:

TOUCH



YOU SEE



## 5. Set Cook Power for second cycle.

To cook at full (100%) power, skip to Step 6.

To cook at another Cook Power:

TOUCH



YOU SEE



Example for 60% Cook Power:

TOUCH



YOU SEE



## 6. Start oven.

TOUCH



YOU SEE



(display counts down cooking time in each cycle)

When cooking time ends, a long tone will sound.

YOU SEE



## Changing or adding instructions

You can change times, Cook Powers or add cycles any time before or after touching START/ENTER:

- Touch OFF/CANCEL twice.
- Enter your new instructions.

## Using POPCORN

POPCORN lets you pop commercially packaged microwave popcorn by touching just one pad. Pop only one package at a time. If you are using a microwave popcorn popper, follow manufacturer's instructions. Cooking performance may vary with brand. Try several brands to decide which gives best popping results. For best results, use fresh bags of popcorn.

### NOTES:

- **Before using POPCORN**, be sure the time of day is showing on the Display. If the time of day is not on the Display, touch OFF/CANCEL once or twice.
- **If you want to change** the popping time after choosing POPCORN, see "Adding or subtracting cook time" on page 35.

## ⚠ WARNING

### Fire and Burn Hazard

- Do not try to repop unpopped kernels and do not reuse popcorn bags. Fire may result.
- If you remove the turntable right after popping popcorn, use oven mitts. It will be very hot and could burn you.

---

1. Place bag in center of turntable and close door.

---

2. Choose POPCORN.

TOUCH

SENSOR POPCORN

YOU SEE

POP CORN

When the sensor detects the vapor emitted by the food, the remainder of the cooking time will show on the Display.

YOU SEE

SENSOR  
COOK 2.05  
AUTO

(display counts down popping time)

---

When popping time ends, a long tone will sound.

YOU SEE

End

## Using REHEAT

You can reheat many foods by touching just one pad. You do not need to calculate cooking time or Cook Power.

### NOTES:

- **Before using REHEAT**, be sure the time of day is showing on the Display. If the time of day is not on the Display, touch OFF/CANCEL once or twice to remove the last program from the Display.
- **If you want to change** the reheating time after choosing REHEAT, see "Adding or subtracting cook time" on page 35.
- **If you want to reheat** by entering time and Cook Power, see "Reheating chart" on page 40.

### 1. Put food in oven and close door.

### 2. Choose REHEAT.

TOUCH



YOU SEE



When the sensor detects the vapor emitted by the food, the Display will show the remainder of the cooking time.

YOU SEE



### 3. When cooking is over, Display shows instructions.

YOU SEE



Open the door

OR TOUCH

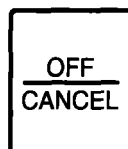

YOU SEE



(time of day)

### 4. To continue with cooking, choose a cooking time and Cook Power (see pages 19-21).



## Using FROZEN ENTREE

FROZEN ENTREE lets you thaw and cook a frozen entree by touching just one pad. You do not need to calculate cooking time or Cook Power.

**NOTES:**

- **Before using** FROZEN ENTREE, be sure the time of day is showing on the Display. If the time of day is not on the Display, touch OFF/CANCEL once or twice to remove the last program from the Display.
- **If you want to change** the cook time after choosing FROZEN ENTREE, see “Adding or subtracting cook time” on page 35.

**1. Put food in oven and close door.**

**2. Choose FROZEN ENTREE.**

TOUCH



YOU SEE



When the sensor detects the vapor emitted by the food, the Display will show the remainder of the cooking time.

YOU SEE

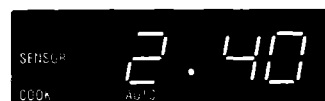

**3. When cooking is over, Display shows instructions.**

YOU SEE



Open the door

OR TOUCH

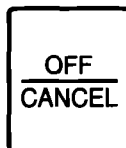

YOU SEE



(time of day)

## Using BAKED POTATOES

BAKED POTATOES lets you bake potatoes by touching just one pad. You do not need to calculate cooking time or Cook Power.

### NOTES:

- **Before using** BAKED POTATOES, be sure the time of day is showing on the Display. If the time of day is not on the Display, touch OFF/CANCEL once or twice to remove the last program from the Display.
- **If you want to change** the cook time after choosing BAKED POTATOES, see "Adding or subtracting cook time" on page 35.

1. Put food in oven and close door.

2. Choose BAKED POTATOES.

TOUCH

SENSOR BAKED POTATOES

YOU SEE

SENSOR

When the sensor detects the vapor emitted by the food, the Display will show the remainder of the cooking time.

YOU SEE

SENSOR  
2.40  
COOK

3. When cooking is over, Display shows instructions.

YOU SEE

COVER STAND

Open the door

OR TOUCH

OFF  
CANCEL

YOU SEE

12:00

(time of day)

## Using ADD MINUTE

ADD MINUTE lets you cook from standing for one minute at 100% Cook Power or add an extra minute to your cooking cycle. You can also use it to extend cooking time in multiples of one minute.

## NOTES

- **To extend** cooking time in multiples of one minute, touch ADD MINUTE repeatedly during cooking.
- **You can enter** ADD MINUTE only after closing the door, after touching OFF/ CANCEL, during cooking, or within one minute after cooking with another function.
- **If you touch** ADD MINUTE during cooking, the oven will cook at the currently selected Cook Power. If you touch ADD MINUTE after cooking, the oven will cook at 100% Cook Power.
- **You cannot use** ADD MINUTE with POPCORN, REHEAT, FROZEN ENTREE, BAKED POTATOES, AUTO COOK, AUTO START, or EASY DEFROST.
- **You cannot use** ADD MINUTE to start the oven if any program is on the Display.

## 1. Make sure food is in oven.

## 2. Choose ADD MINUTE.

Example for cooking for one minute:

TOUCH



YOU SEE

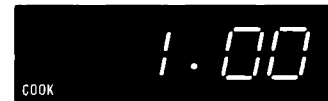

When the cooking time ends, a long tone will sound.

YOU SEE



## Adding or subtracting cook time

If a preset cook time is too long or too short, you can increase or decrease the cook time by 7% after choosing the function.

**NOTE:** When changing cook time, you must touch COOK POWER within two seconds after the last time you touched the chosen function's command pad (for example, EASY DEFROST). After two seconds, cooking will start for the last cook time entered.

To increase cook time by 7%:

TOUCH



YOU SEE



(example for defrost)

To decrease cook time by 7%:

TOUCH



YOU SEE



a second time

## Using PAUSE

PAUSE lets you stop the oven between cooking cycles to stir, turn over food or add ingredients during the cooking process.

1. Put food in oven and close door.

2. Touch in instructions for first cooking cycle.

(See pages 19-21.)

3. Choose PAUSE.

TOUCH



YOU SEE



4. Touch in instructions for second cooking cycle.

(See pages 19-21.)

5. Start oven.

TOUCH



YOU SEE



(example: display counts down cooking time in first cycle)

6. When first cycle is over, four tones will sound.

YOU SEE



Open the door and stir the food.

7. Close door.

TOUCH



YOU SEE

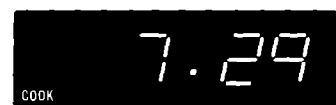

(example: display counts down cooking time in second cycle)

When the cooking time ends, a long tone will sound. When you open the door or touch OFF/CANCEL, you will see the time of day.

YOU SEE



## Using AUTO START

AUTO START lets you program your oven to begin cooking automatically at a time of day you choose. You can preprogram your oven up to 11 hours, 59 minutes in advance.

NOTES:

- If you hear the fan start when you touch START/ENTER, you have not set the oven properly. Touch OFF/CANCEL twice and start over.
- You cannot use AUTO START with ADD MINUTE, EASY DEFROST or POPCORN.
- To check the Auto Start time you set before cooking has started, touch AUTO START/CLOCK. When you lift up on AUTO START/CLOCK, the time of day will reappear on the Display.

### ⚠ WARNING

To avoid sickness and food waste when using AUTO START:

- Do not use foods that will spoil while waiting for cooking to start, such as dishes with milk or eggs, cream soups, and cooked meats or fish. Any food that has to wait for cooking to start should be very cold or frozen before it is put in the oven. MOST UNFROZEN FOODS SHOULD NEVER STAND MORE THAN TWO HOURS BEFORE COOKING STARTS.
- Do not use foods containing baking powder or yeast when using AUTO START. They will not rise properly.
- Do not allow food to remain in oven for more than two hours after end of cooking cycle.

1. Put food in oven and close door.

2. Make sure clock is set to correct time of day.

3. Set start time.

Example for 4:30:

TOUCH

4

3

0

YOU SEE



# USING YOUR MICROWAVE OVEN

## 4. Choose AUTO START.

TOUCH



YOU SEE



## 5. Set cooking time.

Example for 20 minutes:

TOUCH

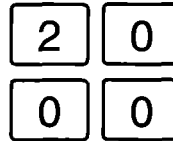

YOU SEE



## 6. Set Cook Power.

To cook at full (100%) power:

TOUCH



YOU SEE



twice

To cook at a lower Cook Power:

TOUCH



YOU SEE



Example for 50% Cook Power:

TOUCH



YOU SEE



## 7. Complete entry.

TOUCH



YOU SEE



(time of day)

The oven will start cooking at the set start time. When the cooking time ends, a long tone will sound. When you open the door or touch OFF/CANCEL, you will see the time of day.

YOU SEE



# Caring For Your Microwave Oven

To make sure your microwave oven looks good and works well for a long time, you should maintain it properly. For proper care, please follow these instructions carefully.

## Cleaning the microwave oven

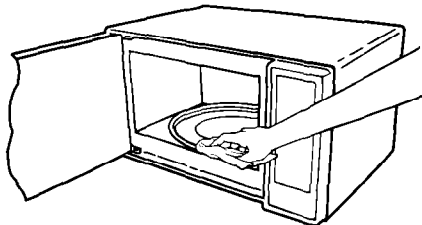

**Wipe** often with warm, sudsy water and a sponge or paper towel. You can remove the glass turntable to clean the oven cavity floor; however, this oven is designed to operate with the turntable in place. **Do not** operate the microwave oven when turntable is removed for cleaning. See page 7 for further information about the turntable.

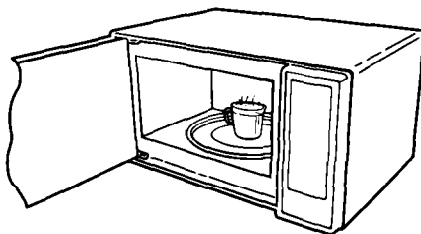

For stubborn soil, **boil** a cup of water in the oven for 2 or 3 minutes. Steam will soften the soil. To get rid of odors inside the oven, **boil** a cup of water with lemon juice.

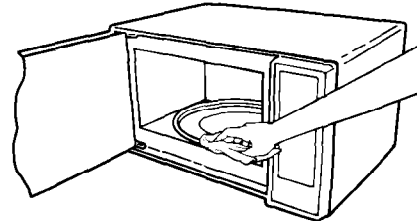

**Be sure to keep the areas clean where the door and oven frame touch when closed. Use** only mild, nonabrasive soaps or detergents applied with a sponge or paper towel when cleaning surfaces. **Rinse** well.

### CAUTION

#### Product Damage Hazard

Abrasive cleansers, steel-wool pads, gritty wash cloths, etc., can damage the control panel, and the interior and exterior oven surfaces. Use a sponge with a mild detergent or a paper towel with spray glass cleaner. Apply spray glass cleaner to paper towel; do not spray directly on oven.

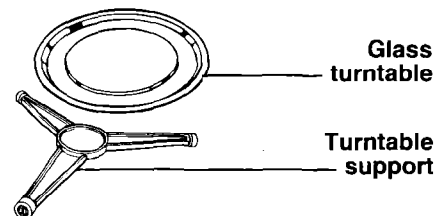

**To clean turntable and turntable support, wash** in mild, sudsy water; for heavily soiled areas **use** a mild cleanser and scouring sponge. The turntable and turntable support are dishwasher-safe.

# Cooking Guide

## Reheating chart

Times are approximate and may need to be adjusted to individual taste.

**NOTE:** For reheating with the sensor, see "Using REHEAT" on page 32.

ITEM	STARTING TEMP	TIME/POWER	PROCEDURE
<b>Meat</b> (Chicken pieces, chops, hamburgers, meat loaf slices) 1 serving 2 servings	Refrigerated Refrigerated	1-2 min at 70% 2½-4½ min at 70%	Cover loosely.
<b>Meat Slices</b> (Beef, ham, pork, turkey) 1 or more servings	Room temp Refrigerated	45 sec-1 min per serving at 50% 1-3 min per serving at 50%	Cover with gravy or wax paper. Check after 30 sec per serving.
<b>Stirrable Casseroles and Main Dishes</b> 1 serving 2 servings 4-6 servings	Refrigerated Refrigerated Refrigerated	2-4 min at 100% 4-6 min at 100% 6-8 min at 100%	Cover. Stir after half the time.
<b>Nonstirrable Casseroles and Main Dishes</b> 1 serving 2 servings 4-6 servings	Refrigerated Refrigerated Refrigerated	5-8 min at 50% 9-12 min at 50% 13-16 min at 50%	Cover with wax paper.
<b>Soup, Cream</b> 1 cup 1 can (10¾ oz)	Refrigerated Room temp	3-4½ min at 50% 5-7 min at 50%	Cover. Stir after half the time.
<b>Soup, Clear</b> 1 cup 1 can (10¾ oz)	Refrigerated Room temp	2½-3½ min at 100% 4-5½ min at 100%	Cover. Stir after half the time.
<b>Pizza</b> 1 slice 1 slice 2 slices 2 slices	Room temp Refrigerated Room temp Refrigerated	15-25 sec at 100% 30-40 sec at 100% 30-40 sec at 100% 45-55 sec at 100%	Place on paper towel.
<b>Vegetables</b> 1 serving 2 servings	Refrigerated Refrigerated	¾-1½ min at 100% 1½-2½ min at 100%	Cover. Stir after half the time.
<b>Baked Potato</b> 1 2	Refrigerated Refrigerated	1-2 min at 100% 2-3 min at 100%	Cut potato lengthwise and then several times crosswise. Cover with wax paper.
<b>Breads</b> (Dinner or breakfast roll) 1 roll 2 rolls 4 rolls	Room temp Room temp Room temp	8-12 sec at 100% 11-15 sec at 100% 18-22 sec at 100%	Wrap single roll, bagel or muffin in paper towel. To reheat several, line plate with paper towel. Cover with another paper towel.
<b>Pie</b> Whole 1 slice	Refrigerated Refrigerated	5-7 min at 70% 30 sec at 100%	



## Microwave cooking chart

Times are approximate and may need to be adjusted to individual taste.

<b>MEATS, POULTRY, FISH, SEAFOOD</b> Allow standing time after cooking.			<b>VEGETABLES (continued)</b> Cook at 100% Cook Power.		
<b>FOOD</b>	<b>COOK POWER</b>	<b>TIME</b>	<b>FOOD</b>	<b>TIME</b>	
<b>Bacon</b>	100%	45 sec to 1 min 15 sec per slice	<b>Carrots (1 lb)</b>	8-12 min	
<b>Ground Beef for Casseroles (1 lb)</b>	100%	4-6 min	<b>Cauliflower (medium head)</b>	6-9 min	
<b>Hamburger Patties (2)</b>	100%	1st side 2 min 2nd side 1½ to 2½ min	<b>Corn on the Cob (2)</b>	4-9 min	
<b>Hamburger Patties (4)</b>	100%	1st side 2½ min 2nd side 2-3 min	<b>Corn on the Cob (4)</b>	6-16 min	
<b>Meat Loaf (1½ lbs)</b>	100%	13-19 min	<b>Potatoes, Baked (4 medium)</b>	13-19 min	
<b>Chicken Pieces</b> Internal temperature should be 185°F after standing.	100%	6-9 min/lb	<b>Squash, Summer (1 lb)</b>	3-8 min	
<b>Turkey Breast</b> Internal temperature should be 185°F after standing.	100% then 70%	5 min 8-12 min/lb	<b>OTHER</b>		
<b>Fish Fillets (1 lb)</b>	100%	5-6 min	<b>FOOD</b>	<b>COOK POWER</b>	<b>TIME</b>
<b>Scallops and Shrimp (1 lb)</b>	100%	3½-5½ min	<b>Applesauce (4 servings)</b>	100%	7-10 min
<b>VEGETABLES</b> Cook at 100% Cook Power.			<b>Baked Apples (4)</b>	100%	4-6 min
<b>FOOD</b>		<b>TIME</b>	<b>Chocolate (melt 1 square)</b>	50%	1-2 min
<b>Beans, Green or Yellow (1 lb)</b>		6-12 min	<b>Eggs, Scrambled (2)</b>	100%	1 min 15 sec to 1 min 45 sec
<b>Broccoli (1 lb)</b>		6-10 min	<b>Eggs, Scrambled (4)</b>	100%	2-3 min
			<b>Hot Cereals (1 serving)</b>	100%	1½-5 min
			<b>Hot Cereals (4 servings)</b>	100%	4½-7 min
			<b>Nachos (large plate)</b>	50%	1½-2½ min
			<b>Water for Beverage (1 cup)</b>	100%	2½-4 min
			<b>Water for Beverage (2 cups)</b>	100%	4½-6 min

## Cooking tips

### Amount of food

- **The more food** you want to prepare, the longer it takes. A rule of thumb is that a double amount of food requires almost double the time. If one potato takes four minutes to cook, you need about seven minutes to cook two potatoes.

### Starting temperature of food

- **The lower the temperature** of the food being put into the microwave oven, the longer it takes to cook. Food at room temperature will be reheated more quickly than food at refrigerator temperature.

### Composition of food

- **Food with a lot of fat and sugar** will be heated faster than food containing a lot of water. Fat and sugar will also reach a higher temperature than water in the cooking process.
- **The more dense the food**, the longer it takes to heat. "Very dense" food like meat takes longer to reheat than lighter, more porous food like sponge cakes.

### Size and shape

- **Smaller pieces of food** will cook faster than larger pieces and same-shaped pieces of food cook more evenly than irregularly shaped foods.
- **With unevenly shaped foods**, the thinner parts will cook faster than the thicker areas. **Place** the thinner parts of chicken wings and legs in the center of the dish.

### Stirring, turning foods

- **Stirring and turning foods** distributes heat quickly to the center of the dish and avoids overcooking at the outer edges of the food.

### Covering food

**Cover food to:**

- **Reduce** splattering
- **Shorten** cooking times
- **Retain** food moisture

All coverings that allow microwaves to pass through are suitable.

### Releasing pressure in foods

- **Several foods** (for example: baked potatoes, sausages, egg yolks, and some fruits) are tightly covered by a skin or membrane. This can cause the food to burst from steam building up in them during cooking. To relieve the pressure and to prevent bursting, **prick** these foods with a fork, cocktail pick or toothpick.

### Using standing time

- **Always allow food to stand** for a while after cooking. Standing time after defrosting, cooking, or reheating always improves the result since the temperature will then be evenly distributed throughout the food.
- **When cooking in a microwave oven**, food continues to cook even when the microwave energy is turned off. Food is no longer cooked by microwaves, but it is still being cooked by the high heat left over from the microwave oven.
- **The length of the standing time** depends on the volume and density of the food. Sometimes it can be as short as the time it takes you to remove the food from the oven and take it to the serving table. However, with larger, denser food, the standing time may be as long as 10 minutes. During standing time, the internal food temperature will rise as much as 46°F as the food finishes cooking.

## Arranging food

For best results, distribute food evenly on the plate. You can do this in several ways:

- **If you are cooking several items of the same food**, such as baked potatoes, **place** them in a ring pattern for uniform cooking.
- **When cooking foods of uneven shapes or thickness**, **place** the smaller or thinner area of the food towards the center of the dish where it will be heated last.
- **Arrange uneven foods**, such as fish, in the oven with the tails to the center.
- **If you are saving a meal in the refrigerator** or "plating" a meal for reheating, **arrange** the thicker, denser foods to the outside of the plate and the thinner or less dense foods in the middle.
- **Place thin slices of meat** on top of each other or interlace them.
- **Place thicker slices of meat**, such as meat loaf and sausages, close to each other.
- **Reheat gravy or sauce** in a separate container.
- **When you cook or reheat whole fish**, **score** the skin – this prevents cracking.
- **Shield the tail and head of whole fish** with small pieces of foil to prevent overcooking and ensure the foil does not touch the sides of the oven.
- **Do not** let food or container touch the top or sides of the oven. This will prevent possible arcing.

## Using aluminum foil

Metal containers usually should not be used in a microwave oven. There are, however, some exceptions. If you have purchased food which is prepackaged in an aluminum foil container, then refer to the instructions on the package. It is possible to use disposable containers, but it generally takes longer

and the final result will not be as good as if food were placed in plastic or paper containers. If you use aluminum containers without package instructions, follow these guidelines:

- **Place** container in a glass bowl and add some water so that it covers the bottom of the container, not more than  $\frac{1}{4}$  inch high. This ensures even heating of the container bottom.
- **Always remove** the lid to avoid damage to the oven.
- **Use only** undamaged containers.
- **Do not use** containers taller than  $\frac{3}{4}$ ".
- **Container must be** half filled.
- **To avoid sparking**, there must be a minimum  $\frac{1}{4}$ " between the aluminum container and the walls of the oven and also between two aluminum containers.
- **Always place** container on turntable.
- **Thickness of the food layer** must be greater than thickness of the aluminum.
- **Reheating food** in aluminum foil containers usually takes up to double the time compared to reheating in plastic, glass, china, or paper containers. The time when food is ready will vary a great deal.
- **Let food stand** for 2-3 minutes after heating so that heat is spread evenly throughout container.

## Cooking you should not do in your microwave oven

- **Do not** do canning of foods in the oven. Closed glass jars may explode, resulting in damage to the oven or possible personal injury.
- **Do not** use the oven to sterilize objects (baby bottles, etc.). It is difficult to maintain the high temperature required for safe sterilization.

# Questions And Answers

QUESTIONS	ANSWERS
Can I operate my microwave oven without the turntable or turn the turntable over to accommodate a large dish?	No. If you remove or turn over the turntable, you will get poor cooking results. Dishes used in your oven must fit on the turntable.
Can I use a rack in my microwave oven so that I may reheat or cook on two levels at a time?	You can use a rack only if rack is supplied with your microwave oven. Use of any rack not supplied with the microwave oven can result in poor cooking performance and/or arcing.
Can I use either metal or aluminum pans in my microwave oven?	Useable metal includes aluminum foil for shielding (use small, flat pieces), small skewers and shallow foil trays (if tray is 3/4 inch deep and filled with food to absorb microwave energy). Never allow metal to touch walls or door. (For more information, see page 43.)
Is it normal for the turntable to turn in either direction?	Yes. The turntable rotates clockwise or counterclockwise, depending on the rotation of the motor when the cooking cycle begins.
Sometimes the door of my microwave oven appears wavy. Is this normal?	This appearance is normal and does not affect the operation of your oven.
What are the humming noises that I hear when my microwave oven is operating?	You hear the sound of the transformer when the magnetron tube cycles on.
Why does the dish become hot when I microwave food in it? I thought that this should not happen.	As the food becomes hot it will conduct the heat to the dish. Be prepared to use hot pads to remove food after cooking.
What does "standing time" mean?	"Standing time" means that food should be taken out of the oven and covered for additional time after cooking. This process allows the cooking to finish, saves energy and frees the oven for another purpose.
Can I pop popcorn in my microwave oven? How do I get the best results?	Yes. Pop packaged microwave popcorn following manufacturer's guidelines or use the preprogrammed Popcorn pad. Do not use regular paper bags. Use the "listening test" by stopping the oven as soon as the popping slows to a "pop" every one or two seconds. Do not try to repop unpopped kernels. You can also use special microwave poppers. When using a popper, be sure to follow manufacturer's directions. Do not pop popcorn in glass utensils.

# If You Need Assistance Or Service

This section is designed to help you save the cost of a service call. Part 1 of this section outlines possible problems, their causes, and actions you can take to solve each problem. Parts 2 and 3 tell you what to do if you still need assistance or service. When calling our Consumer Assistance Center for help or calling for service, please provide a detailed description of the problem, your appliance's complete model and serial numbers and the purchase date. (See page 2.) This information will help us respond properly to your request.

## 1. Before calling for assistance ...

Performance problems often result from little things you can find and fix without tools of any kind. Please check the chart below for problems you can fix. It could save you the cost of a service call.

<b>PROBLEM</b>	<b>POSSIBLE CAUSE</b>	<b>SOLUTION</b>
<b>Nothing will operate</b>	<p>The power supply cord is not plugged into a live circuit with the proper voltage.</p> <p>A household fuse has blown or a circuit breaker has tripped.</p> <p>The electric company has experienced a power failure.</p>	<p>Plug power supply cord into a live circuit with the proper voltage. (See pages 7 and 9.)</p> <p>Replace household fuse or reset circuit breaker.</p> <p>Check electric company for a power failure.</p>
<b>The microwave oven will not run</b>	<p>You are using the oven as a timer.</p> <p>The door is not firmly closed and latched.</p> <p>You did not touch START/ENTER.</p> <p>You did not follow directions exactly.</p> <p>An operation that was programmed earlier is still running.</p>	<p>Touch OFF/CANCEL to cancel the Minute Timer.</p> <p>Firmly close and latch door.</p> <p>Touch START/ENTER.</p> <p>Check instructions for the function you are operating.</p> <p>Touch OFF/CANCEL to cancel previous programming.</p>
<b>Microwave cooking times seem too long</b>	<p>The electric supply to your home or wall outlets is low or lower than normal.</p> <p>The Cook Power is not at the recommended setting.</p> <p>There is not enough cooking time for the amount of food being cooked.</p>	<p>Your electric company can tell you if the line voltage is low. Your electrician or service technician can tell you if the outlet voltage is low.</p> <p>Check "Microwave cooking chart" on page 41.</p> <p>Allow for more time when cooking more food at one time.</p>

continued on next page

## IF YOU NEED ASSISTANCE OR SERVICE

PROBLEM	POSSIBLE CAUSE	SOLUTION
<b>The Display shows a time counting down but the oven is not cooking</b>	You have set the controls as a kitchen timer.	Touch OFF/CANCEL to cancel the Minute Timer.
<b>You do not hear the Programming Tone</b>	The command is not correct.	Re-enter command.
<b>The fan seems to be running slower than usual</b>	The oven has been stored in a cold area.	The fan will run slower until the oven warms up to normal room temperature.
<b>The Display is flashing "88:88"</b>	There has been a power interruption.	Reset the clock. (See page 16.)

**2. If you need assistance ...**

Call Whirlpool Consumer Assistance Center telephone number. Dial toll-free from anywhere in the U.S.A.:

**1-800-253-1301**

and talk with one of our trained consultants. The consultant can instruct you in how to obtain satisfactory operation from your appliance or, if service is necessary, recommend a qualified service company in your area.

If you prefer, write to:

Mr. William Clark  
Consumer Assistance Representative  
Whirlpool Corporation  
2000 M-63  
Benton Harbor, MI 49022

Please include a daytime phone number in your correspondence.

**3. If you need service ...**



Whirlpool has a nationwide network of authorized Whirlpool® service companies. Whirlpool

service technicians are trained to fulfill the product warranty and provide after-warranty service, anywhere in the United States. To locate the authorized Whirlpool service company in your area, call our Consumer Assistance Center telephone number (see Step 2) or look in your telephone directory Yellow Pages under:

**• APPLIANCE-HOUSEHOLD-MAJOR, SERVICE & REPAIR**

- See: Whirlpool Appliances or Authorized Whirlpool Service  
(Example: XYZ Service Co.)

**• WASHING MACHINES & DRYERS, SERVICE & REPAIR**

- See: Whirlpool Appliances or Authorized Whirlpool Service  
(Example: XYZ Service Co.)

**4. If you are not satisfied with how the problem was solved ...**

- Contact the Major Appliance Consumer Action Panel (MACAP). MACAP is a group of independent consumer experts that voices consumer views at the highest levels of the major appliance industry.
- Contact MACAP only when the dealer, authorized servicer and Whirlpool have failed to resolve your problem.

Major Appliance Consumer Action Panel

20 North Wacker Drive  
Chicago, IL 60606

- MACAP will in turn inform us of your action.

# WHIRLPOOL®

## Microwave Oven Warranty

LENGTH OF WARRANTY	WHIRLPOOL WILL PAY FOR
<b>FULL ONE-YEAR WARRANTY</b> From Date of Purchase	FSP® replacement parts and repair labor to correct defects in materials or workmanship. Service must be provided by an authorized Whirlpool® service company.
<b>LIMITED FOUR-YEAR WARRANTY</b> Second Through Fifth Year From Date of Purchase	FSP replacement magnetron tube on microwave ovens if defective in materials or workmanship.
<b>WHIRLPOOL WILL NOT PAY FOR</b>	
<p><b>A. Service calls to:</b></p> <ol style="list-style-type: none"> <li>1. Correct the installation of your microwave oven.</li> <li>2. Instruct you how to use your microwave oven.</li> <li>3. Replace house fuses or correct house wiring.</li> <li>4. Replace owner accessible light bulbs.</li> </ol> <p><b>B. Repairs when your microwave oven is used in other than normal, single-family household use.</b></p> <p><b>C. Pickup and delivery. Your microwave oven is designed to be repaired in the home.</b></p> <p><b>D. Damage to your microwave oven caused by accident, misuse, fire, flood, acts of God or use of products not approved by Whirlpool.</b></p> <p><b>E. Any labor costs during limited warranty.</b></p> <p><b>F. Repairs to parts or systems caused by unauthorized modifications made to the appliance.</b></p>	

5/93

WHIRLPOOL CORPORATION SHALL NOT BE LIABLE FOR INCIDENTAL OR CONSEQUENTIAL DAMAGES. Some states do not allow the exclusion or limitation of incidental or consequential damages, so this limitation or exclusion may not apply to you. This warranty gives you specific legal rights, and you may also have other rights which vary from state to state.

Outside the United States, a different warranty may apply. For details, please contact your authorized Whirlpool distributor or military exchange.

If you need service, first see the "Assistance or Service" section of this book. After checking "Assistance or Service," additional help can be found by calling our Consumer Assistance Center telephone number, **1-800-253-1301**, from anywhere in the U.S.A.



Printed on recycled paper—  
10% post consumer waste  
50% recovered materials

**PART NO. TINSEB101MRR0/4313759 Rev. A**

© 1993 Whirlpool Corporation

® Registered Trademark / TM Trademark of Whirlpool Corporation.

Printed in U.S.A.