



HOW TO MAKE A HOME RUN.™

# Use And Care

## G U I D E



<b>A Note to You</b> .....	2
<b>Cooktop Safety</b> .....	3-5
<b>Getting to Know Your Cooktop</b> .....	6
Air shutter adjustment .....	7
LO flame adjustment .....	8
<b>Controls</b> .....	9
Using .....	9
Caring for .....	11
<b>Surface Burners</b> .....	12
Installing .....	12
Using .....	15
Caring for .....	16
<b>Grill</b> .....	18
Installing .....	18
Using .....	20
Caring for .....	23
<b>Griddle</b> .....	25
Installing .....	25
Using .....	26
Caring for .....	28
<b>Vent</b> .....	29
Using .....	29
Caring for .....	30
<b>Troubleshooting</b> .....	31
<b>Requesting Assistance or Service</b> .....	33
<b>Warranty</b> .....	36

### 30" GAS MODULAR DOWNDRAFT COOKTOP

TO THE INSTALLER: PLEASE LEAVE THIS INSTRUCTION BOOK WITH THE UNIT.

TO THE CONSUMER: PLEASE READ AND KEEP THIS BOOK FOR FUTURE REFERENCE.

PART NO. 209810B/4381592 Rev. A

**1-800-253-1301**

Call us with questions or comments.

**MODEL SC8720ED**

# A Note to You

## Thank you for buying a WHIRLPOOL® appliance.

Because your life is getting busier and more complicated, WHIRLPOOL cooktops are easy to use, save time, and help you manage your home better. To ensure that you enjoy years of trouble-free operation, we developed this Use and Care Guide. It is full of valuable information about how to operate and maintain your appliance properly and safely. Please read it carefully.

Also, please complete and mail in the Product Registration Card provided with your appliance. The card helps us notify you about any new information on your appliance.

## Please record your model's information.

Whenever you call to request service for your appliance, you need to know your complete model number and serial number. You can find this information on the model and serial number plate (see diagram on page 6 for location of plate).

Please also record the purchase date of your appliance and your dealer's name, address, and telephone number.

Model Number \_\_\_\_\_

Serial Number \_\_\_\_\_

Purchase Date \_\_\_\_\_

Dealer Name \_\_\_\_\_

Dealer Address \_\_\_\_\_

Dealer Phone \_\_\_\_\_

**Keep this book and the sales slip together in a safe place for future reference.**

**Our Consumer Assistance Center  
number is toll-free 24 hours a day.**

**1-800-253-1301**

**WARNING: If the information in this manual is not followed exactly, a fire or explosion could result causing death, personal injury, or property damage.**

**Do not store or use gasoline or other flammable vapors and liquids in the vicinity of this or any other appliance.**

### WHAT TO DO IF YOU SMELL GAS:

- Do not try to light any appliance.
- Do not touch any electrical switch; do not use any phone in your building.
- Immediately call your gas supplier from a neighbor's phone. Follow the gas supplier's instructions.
- If you cannot reach your gas supplier, call the fire department.

**Installation and service must be performed by a qualified installer, service agency, or the gas supplier.**

**– SAVE THESE INSTRUCTIONS FOR FUTURE REFERENCE –**

# Cooktop Safety

## Your safety is important to us.

This guide contains safety statements under warning symbols. Please pay special attention to these symbols and follow any instructions given. Here is a brief explanation of the use of the symbol.

## **WARNING**

This symbol alerts you to such dangers as fire, electrical shock, burns, and personal injury.

## IMPORTANT SAFETY INSTRUCTIONS READ AND SAVE THESE INSTRUCTIONS

Gas cooktops have been thoroughly tested for safe and efficient operation. However, as with any appliance, there are specific installation and safety precautions which must be followed to ensure safe and satisfactory operation.

## **WARNING**

To reduce the risk of fire, electrical shock, injury to persons, or damage when using the cooktop, follow basic precautions, including the following:

### General

- Install or locate the cooktop only in accordance with the provided Installation Instructions. The cooktop must be installed by a qualified installer. The cooktop must be properly connected to the proper gas supply and checked for leaks. The cooktop must also be properly connected to electrical supply and grounded.
- Gas fuels and their use in appliances could cause minor exposures to benzene, formaldehyde, carbon monoxide, and soot, primarily from incomplete combustion. Significant exposure to these substances could cause cancer or reproductive harm. Properly adjusted burners with a blue, rather than a yellow, flame will minimize incomplete combustion. Venting with a hood or an open window will further minimize exposure.
- **CAUTION:** Do not store things children might want above the cooktop. Children could be burned or injured while climbing on it.

- Do not leave children alone or unattended in area where the cooktop is in use. They should never be allowed to sit or stand on any part of the cooktop. They could be burned or injured.
- Do not operate the cooktop if it is damaged or not working properly.
- Do not use the cooktop for warming or heating the room. Persons could be burned or injured, or a fire could start.
- Use the cooktop only for its intended use as described in this manual.



- Do not touch grill and surface burner areas, or perimeter trim around cooktop. During and after use, these areas may be hot enough to cause burns. Avoid contact with these areas by clothing or other flammable materials until they have had sufficient time to cool.

continued on next page



- Do not wear loose or hanging garments when using the cooktop. They could ignite if they touch an open flame and you could be burned.
- Use only dry pot holders. Moist or damp pot holders on hot surfaces could result in burns from steam. Do not let pot holder touch an open flame. Do not use a towel or bulky cloth for a pot holder. It could catch on fire.
- Do not heat unopened containers. They could explode. The hot contents could cause burns and container particles could cause injury.
- Do not store flammable materials on or near the cooktop. The fumes could create an explosion and/or fire hazard.
- Do not use aluminum foil to line aeration tray, burner basin, or any other part of the cooktop. Use aluminum foil only as recommended in this manual.
- A faint gas odor may indicate a gas leak. If a gas odor is detected, shut off the gas supply to the cooktop. Call your installer or local gas company to have the possible leak checked. Never use a match or other flame to locate a gas leak. Explosion and injury could result.
- Know where your main gas shutoff valve is located.

## When using the cooktop

- Make sure the utensils you use are large enough to contain food and avoid boilovers and spillovers. Heavy splattering or spillovers left on a cooktop could ignite and burn you. Pan size is especially important in deep fat frying.

- Check to be sure glass cooking utensils are safe for use on the cooktop. Only certain types of glass, glass-ceramic, ceramic, earthenware, or other glazed utensils are suitable for cooktops without breaking due to the sudden change in temperature.
- Never leave surface burners unattended at high heat settings. A boilover could result and cause smoking and greasy spillovers that could ignite.



- Turn pan handles inward, but not over other surface burners. This will help reduce the chance of burns, igniting of flammable materials, and spills due to bumping of the pan.
- Do not use decorative covers or trivets over the surface burners.

## Grease

- Grease is flammable. Do not allow grease to collect around cooktop. Wipe spillovers immediately.



- Do not use water on grease fires. Never pick up a flaming pan. Smother flaming pan by covering with a well-fitted lid, cookie sheet, or flat tray. Flaming grease outside of pan can be extinguished with baking soda or, if available, a multi-purpose dry chemical or foam-type extinguisher.

### **Care and cleaning**

---

- Do not repair or replace any part of the cooktop unless specifically recommended in this manual. All other servicing should be referred to a qualified technician.
- Any additions, changes, or conversions required in order for this appliance to satisfactorily meet the application needs must be made by a Whirlpool service company or Qualified Agency.
- Disconnect the electrical supply and the gas supply at the shut-off valve near the cooktop before servicing the cooktop.

### **Additional safety precautions**

---

- Avoid pans that are unstable and easily tipped. In choosing pans, look for easily-grasped handles that will stay cool. Pans that are too heavy when filled with food can also be a hazard. If pan handles twist and cannot be tightened, discard the pan.
- Keep all controls "OFF" when cooktop is not in use.
- Keep vent ducts unobstructed.
- If the cooktop is installed near a window, proper precautions should be taken to prevent curtains from blowing over burners creating a FIRE HAZARD.
- Do not use cookware on the grill section of this appliance.
- Always allow hot pans to cool in a safe place out of the reach of small children.
- Clean only parts listed in this manual and use procedures recommended.
- Flame size should be adjusted so it does not extend beyond the edge of the cookware, this instruction is based on safety considerations.
- This appliance has been tested for safe performance using conventional cookware. Do not use any devices or accessories that are not specifically recommended in this manual. Do not use eyelid covers for the surface burners or stovetop grills. The use of devices or accessories that are not expressly recommended in this manual can create serious safety hazards, result in performance problems, and reduce the life of the components of the appliance.

**– READ AND SAVE THESE INSTRUCTIONS –**

# Getting to Know Your Cooktop

This section contains captioned illustrations of your cooktop. Use them to become familiar with the location and appearance of all parts and features. To help you find information on specific parts and features quickly, page references are included.

**Optional griddle accessory**

(p.n. SCM40DB)  
(pp. 25-28)

**Optional grill cover accessory**

(p.n. SCM50DB/Q)  
(pp. 21, 24)

**Optional grill accessory**

(p.n. SCM20DB)  
(pp. 18-24)

**Optional surface burner accessory**

(p.n. SCM10DB/DW)  
(pp. 12-17)

**Basin**

**Drain Jar**

**Air grille**

**Vent**  
(pp. 29-30)

**Surface burners and grates**  
(pp. 12-17)

**Control panel**  
(pp. 9-11)

**Vent chamber**

**Model and serial number plate**

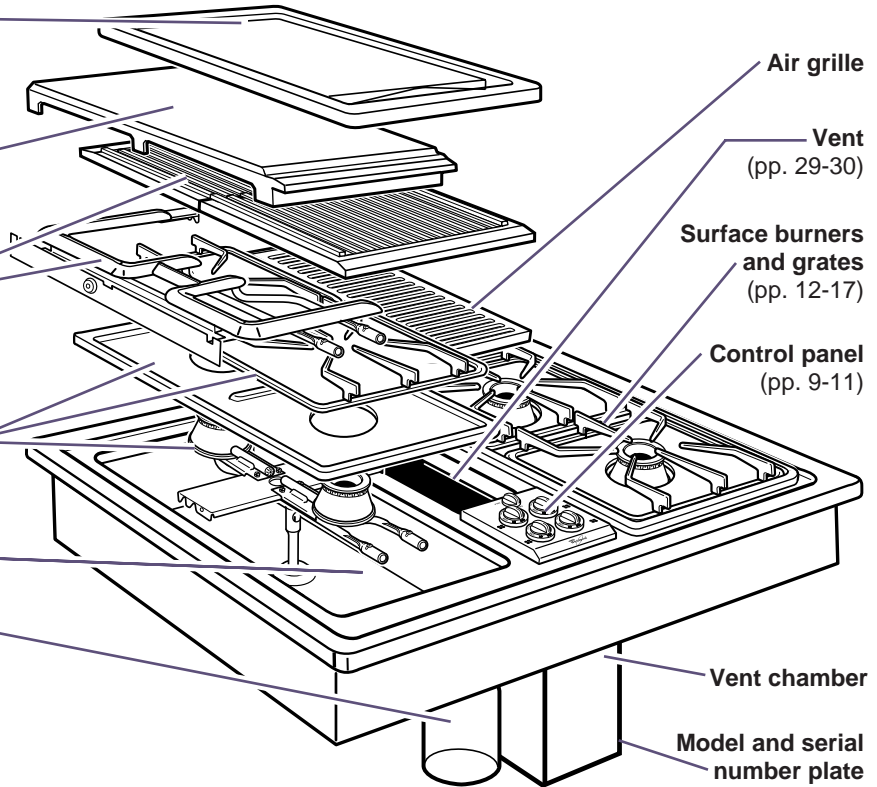

## Control panel

**Left rear control knob**  
(pp. 9-11)

**Left front control knob**  
(pp. 9-11)

**Vent fan control knob**  
(p. 29)

**Right rear control knob**  
(pp. 9-11)

**Right front control knob**  
(pp. 9-11)

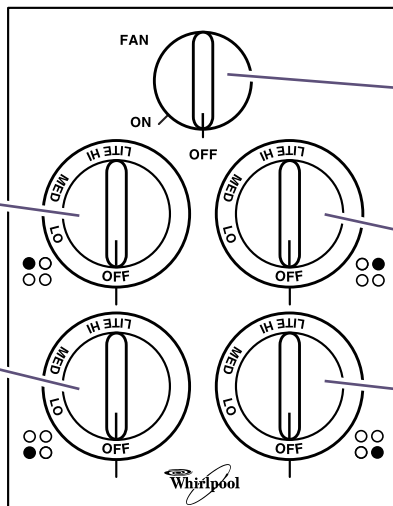

## Air shutter adjustment

### To adjust grill burner air shutters or surface burner air shutters

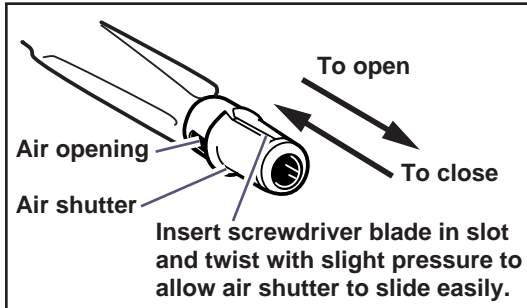

The left air shutter controls the rear half of the grill burner. The right shutter controls the front half.

Slide the air shutter backward or forward to increase or decrease the size of the air opening. Air shutters fit snugly on the grill burner, so you may need a screwdriver blade to make the adjustment. Notice how the flame changes as you move the air shutter. The adjustment is satisfactory when you get a clearly defined, even blue flame at the HI flame setting. The snug fit of the air shutter will allow it to remain positioned correctly.

On any burner, closing the air shutter too far will cause the flame to become soft and yellow tipped. Opening the air shutter too wide will cause the flame to blow away from the burner ports. Proper adjustment will produce a sharp, clearly defined, even blue flame.

### To adjust surface burner air shutter (on some models)

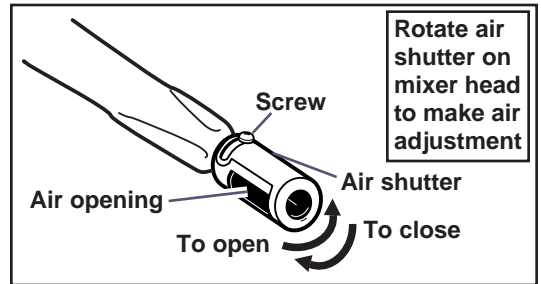

Loosen the fastening screw with a phillips screwdriver and rotate the air shutter to increase or decrease the size of the air opening. As you turn the shutter notice how the flame changes. The adjustment is satisfactory when you get a clearly defined, even blue flame at the HI flame setting. After the adjustment, tighten the screw.

## LO flame adjustment

This appliance has been shipped from the factory with LO and MED flame settings adjusted for use with natural gas and average installations. There is a wide variety of conditions caused by altitude and gas mixtures controlled by utility companies which will vary and affect the gas flame and performance. Adjustments should be made at time of installation. If conditions change, follow the procedures outlined below to adjust the LO setting.

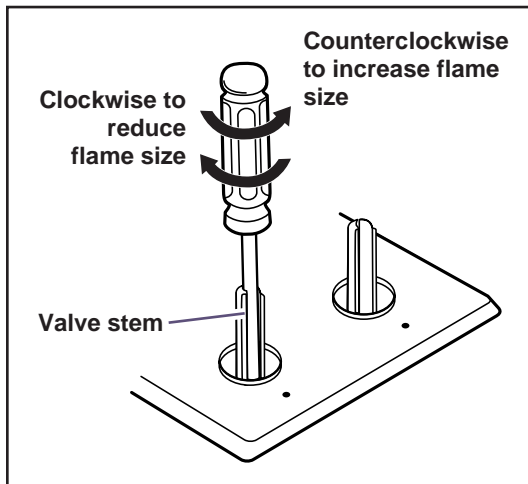

1. **Light** the burner and set the control knob for a low flame.
2. **Remove** the control knob from the valve stem.  
**IMPORTANT:** Never use a metal blade to pry the knob off. If you cannot easily remove the knob tuck the folds of a cloth dishtowel under the knob skirt and pull the towel upward with steady, even pressure.
3. **Insert** a slender, thin-blade screwdriver into the recess at the center of the valve stem and insert the blade in the slot of the adjusting screw.

4. **Turn** the center stem adjusting screw slightly to set the flame size.

**NOTE:** Turn clockwise to reduce or counterclockwise to increase the flame size.

5. **Replace** the control knob when you have completed the adjustment.

Proper adjustment will produce a stable, steady blue flame of minimum size. The final adjustment should be checked by turning the knob from HI to LO several times without extinguishing the flame. This adjustment, at the LO setting, will automatically provide the proper flame size at the MED setting.



# Controls

## **⚠️ WARNING**



### **Explosion Hazard**

**Do not store flammable materials such as gasoline near the cooktop.**

**Doing so can result in death, explosion, fire, or burns.**

## **⚠️ WARNING**

**Carbon Monoxide Poisoning Hazard**

**Do not operate with a yellow flame.**

**Doing so can result in death, heart attack, or convulsions.**

## Using

Your cooktop has electric igniters. Electric igniters light the burners each time the controls are turned to LITE.

### Turning the knobs

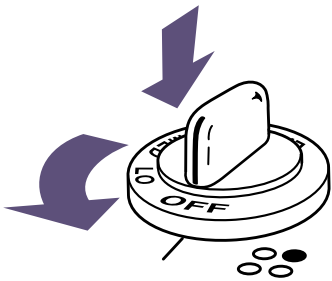

**Push down on control knob and turn counterclockwise** to the LITE position. The clicking sound is the ignitor sparking. **Look at the burner to make sure it has lit.**

**To stop the clicking sound after the burner lights, turn the control knob to the cook setting you want.** The control knob has three cook settings. However, you can set the control knob anywhere between HI and LO.

### **Cooking on the left side**

The LO setting is the lowest setting you can use for the grill burner. However, when you use surface burners on the left side of the cooktop you can turn the control knob lower than the LO setting.

### **Cooking on the right side**

You can only use surface burners on the right side of the cooktop. You cannot install either the grill or the griddle on the right side of the cooktop.

## CONTROLS

Until you get used to the settings, use the following as a guide. For best results, start cooking at the high setting; then turn the control knob down to continue cooking.

SETTING	RECOMMENDED USE
LITE	<ul style="list-style-type: none"><li>• To light the burner. After the burner lights, turn control back to a desired setting to stop the clicking of the ignitor.</li></ul>
HI (High)	<ul style="list-style-type: none"><li>• To start foods cooking.</li><li>• To bring liquids to a boil.</li></ul>
Medium High	<ul style="list-style-type: none"><li>• To hold a rapid boil.</li><li>• To fry chicken.</li></ul>
MED	<ul style="list-style-type: none"><li>• For gravy, pudding, and most frying.</li><li>• To cook large amounts of vegetables.</li></ul>
Medium Low	<ul style="list-style-type: none"><li>• To keep food cooking.</li><li>• To poach and stew.</li><li>• To simmer.</li></ul>
LO	<ul style="list-style-type: none"><li>• To keep food warm until ready to serve.</li><li>• To melt.</li></ul>

**NOTE:** Do not cook with the control set at LITE.

### In case of a long power failure

Surface burners can be lit by hand. Hold a lit match near a burner and turn the control knob to the LITE setting. After the burner lights, turn the control knob to the setting you want.

Do not use the grill during a power failure. The vent fan will not work.

## WARNING



### Explosion Hazard

Turn the burners off if a flame goes out while cooking, or if there is a strong gas odor. Wait five minutes for the gas odor to disappear before relighting burner. If gas odor is still present, see safety note on page 2.

Do not let the burner flame extend beyond the edge of the pan.

Turn off all control knobs when not cooking.

Failure to do so can result in death, explosion, fire, or burns.

### NOTES:

- **Do not leave** an empty utensil, or one which has boiled dry, on a hot surface burner. The utensil could overheat and damage the utensil or cooking surface.
- **Do not allow** large pans to extend over the control knobs. Heat trapped between large pans and control knobs could possibly damage the control knobs.

## Caring for controls

**NOTE:** Do not use oven cleaners, bleach, or rust removers to clean any part of the cooktop. Use this chart to help you clean your control knobs and panel.

PART	WHAT TO USE	HOW TO CLEAN
<b>Control knobs</b>	Sponge and warm, soapy water <b>OR</b> Dishwasher	<ul style="list-style-type: none"> <li>• Turn knobs to OFF and pull straight up.</li> <li>• Wash, rinse, and dry well. Do not soak.</li> <li>• <b>Do not use steel wool or gritty cleansers. They may damage the finish.</b></li> <li>• Replace knobs. Make sure all knobs point to OFF.</li> </ul>
<b>Control panel</b>	Sponge and warm, soapy water <b>OR</b> Paper towel and mild liquid soap	<ul style="list-style-type: none"> <li>• Wash, wipe with clean water, and dry well.</li> <li>• <b>Do not use steel wool or gritty cleansers. They may damage the finish.</b></li> <li>• Do not spray cleaner directly on panel. Spray cleaner on paper towel.</li> </ul>

# Surface Burners

## ⚠️ WARNING



### Explosion Hazard

Do not store flammable materials such as gasoline near the cooktop.

Doing so can result in death, explosion, fire, or burns.

## ⚠️ WARNING

### Carbon Monoxide Poisoning Hazard

Do not operate with a yellow flame.

Doing so can result in death, heart attack, or convulsions.

## Installing

You can install extra surface burners on the left side of your cooktop. To get the surface burner accessory, order Part Number SCM10DB/DW from a Whirlpool service company or dealer (see Step 2 on page 33) or call the Whirlpool Consumer Assistance Center toll-free **1-800-253-1301**.

**NOTE:** Do not take apart the surface burner accessory.

### To install:

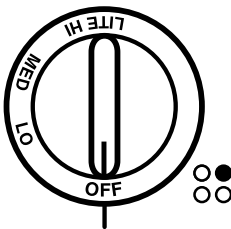

1. **Make sure** the control knobs are turned off.

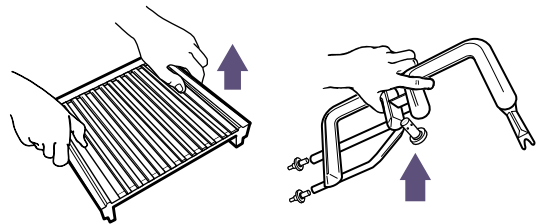

2. If the grill burner and grates are in place, **remove** them before installing surface burners. **Clean out** any grease that may be in the burner basin. (See pages 19 and 24 for more information.)

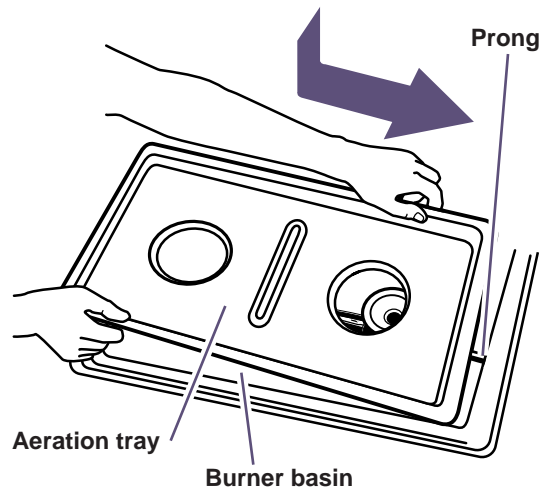
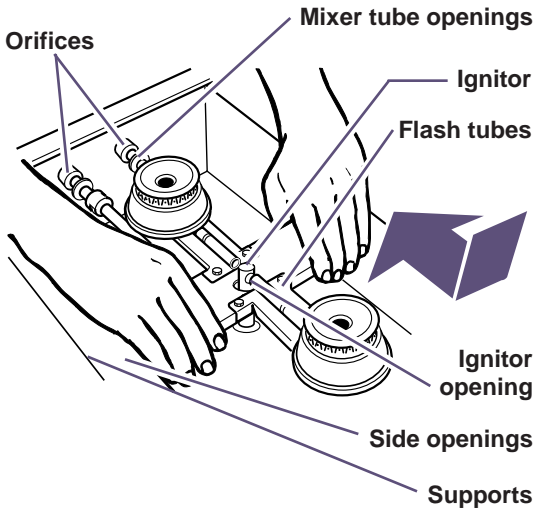

3. **Set** the surface burner accessory into place. Mixer tube openings should be pointed toward the orifices. **Slide** the burner toward the orifices until the opening for the ignitor is over the ignitor. **Lower** into place until the notches in the side of the burner bracket rest on the burner supports, and the ignitor is centered between the two flash tubes. Be sure mixer tubes are over the orifices.

4. **Set** the aeration tray into place. **Insert** the prong at the end of the tray into the opening in the end of the burner basin. **Lower** the other end into the cooktop.

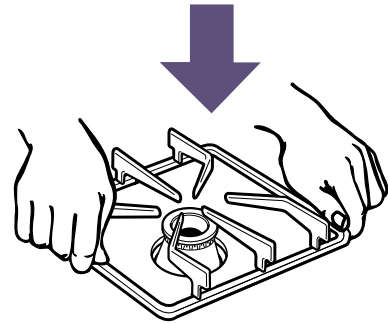

5. **Place** burner grates on aeration tray.

# SURFACE BURNERS

## To remove:

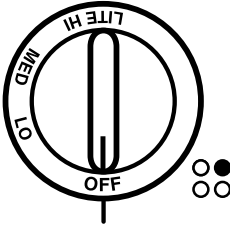

1. **Make sure** the control knobs are turned off and the cooktop is cool.

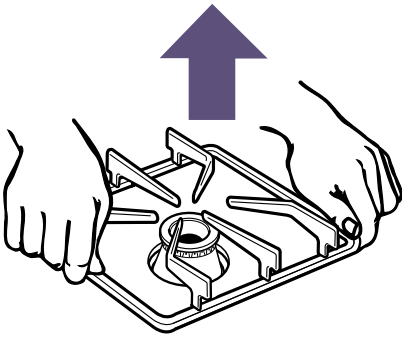

2. **Remove** burner grates.

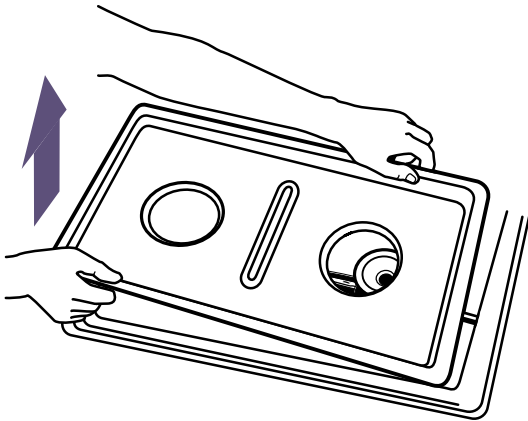

3. **Remove** the aeration tray by lifting up the front end on the right side (back end on the left side). **Lift** until the top clears the opening of the cooktop by about five inches.

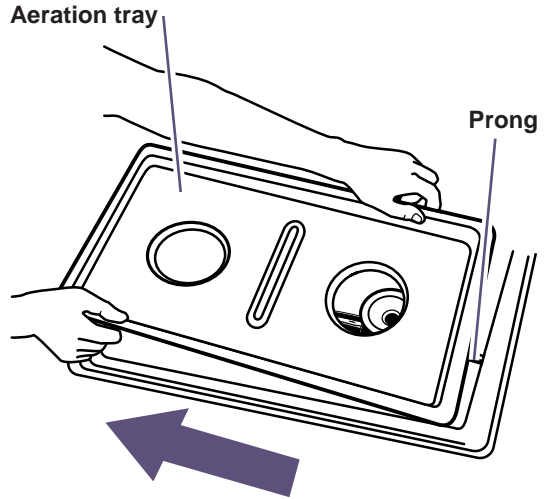

4. **Hold** the aeration tray by the sides and **slide away** to remove the prong from the opening and clear the surface burners.

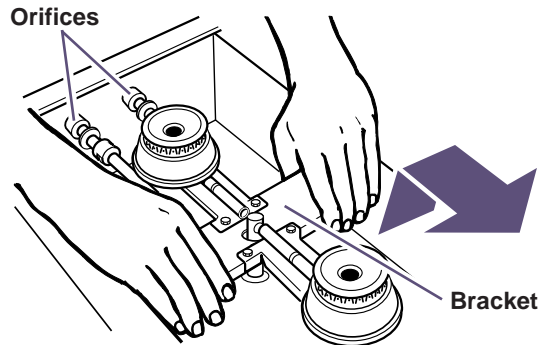

5. **Lift up** on the sides of the surface burner accessory bracket about two inches. **Slide away** from the orifices.

## Using

### Cookware tips

No one brand of cookware is best for all people. Knowing something about pan materials and construction will help you select the correct cookware for your needs.

- **NOTE: For best results and greater fuel efficiency**, use only flat-bottomed cookware in good condition.
- **The pan** should have straight sides and a tight-fitting lid.
- **Choose medium to heavy gauge** (thickness) pans that are fairly lightweight.
- **The pan material** (metal or glass) affects how fast heat transfers from the surface burners through the pan material and how evenly heat spreads over the pan bottom. Choose pans that provide the best cooking results.
- **IMPORTANT: Do not allow** large pans to contact or extend over the control knobs. Heat trapped between large pans and control knobs could possibly damage the control knobs.
- **IMPORTANT: Leave** a minimum of 1½" between the side of the pan and surrounding surfaces, such as countertop backsplash or side walls. This allows heat to escape, avoiding possible damage to these areas.
- **Handles** should be made of a sturdy, heat-resistant material and be securely attached to the pan.
- **Pans** should be easy to clean. Check to be sure there are no crevices, rough edges, or areas where food might collect.
- **Be sure pans** do not tip, whether they are full or empty.
- **Use cookware** only as it was intended to be used. Follow pan instructions. This is very important for glass cookware because some should be used only in the oven. Other pans are marked as flameware and may be used on the surface burners.

### Home canning information

The larger diameter of most water-bath or pressure canners combined with high heat settings for long periods of time can cause damage to the cooktop.

#### To protect your cooktop:

- **For best results**, use a canner which can be centered over the surface burner.
- **Do not place canner** on two surface burners at the same time. Too much heat will build up and will damage the cooktop.
- **Start with hot water**. This reduces the time the control is set on HI. Reduce heat setting to lowest position needed to keep water boiling.
- **Refer** to your canner manual for specific instructions.

### Energy saving tips

Although the energy used for cooking is usually a very small percentage of the total energy used in the home, cooking energy can be used efficiently. Here are some tips to help you save energy when using your cooking product:

- **Use** pans with flat bottoms, straight sides, and tight-fitting lids.
- **Cook** with a minimum of liquid or fat to help shorten cooking time.
- **Preheat** pans only when recommended and for the shortest time possible.
- **Start** food on higher heat settings, then set surface burner control on LO to finish cooking.
- **Turn on** the surface burner only after placing filled pan on the burner grate.
- **Plan** your meals for the most efficient use of the cooktop.
- **Cover** pans.

## Caring for surface burners

Use this chart to help you clean your surface burner accessory.

PART	WHAT TO USE	HOW TO CLEAN
<b>Surface burner grates</b>	Warm, soapy water and a nonabrasive, plastic scrubbing pad <b>OR</b> Dishwasher	<ul style="list-style-type: none"> <li>• In dishwasher, wash with other cooking utensils.</li> <li>• Dry completely.</li> <li>• <b>Do not use gritty or harsh cleansers. They may damage the finish.</b></li> <li>• Although the burner grate is durable, it will gradually lose its shine and/or discolor, regardless of the care you take of it. This is due to its exposure to the high temperature of the gas flames. To preserve the porcelain enamel finish as long as possible, have a pan on the grate before you turn on the burner, and lower the flame when the food reaches the desired cooking temperature.</li> </ul>
<b>Surface burners/ exterior surfaces/ area under burners/ aeration tray</b>	Warm, soapy water and a sponge Warm, soapy water and a nonabrasive, plastic scrubbing pad	<ul style="list-style-type: none"> <li>• Wipe off spills immediately after burner has cooled.</li> <li>• <b>For cooked-on food:</b></li> <li>• Wash with warm, soapy water and a plastic scrubbing pad.</li> <li>• Rinse with clean water and dry well.</li> <li>• If ports are clogged, clean with a straight pin. <b>Do not enlarge or distort ports. Do not use a wooden toothpick.</b></li> <li>• Do not clean surface burner in dishwasher or self-cleaning oven.</li> <li>• <b>Do not use gritty or harsh cleansers. They may damage the finish.</b></li> </ul> <p><b>NOTE:</b> Do not allow foods containing acids (such as vinegar, tomato, or lemon juice) to remain on surface. Acids may remove the glossy finish. Also, wipe up milk or egg spills when cooktop is cool. Remove sugar spills immediately.</p>
<b>Ignitor cap and stem</b>	Warm, soapy water and a nonabrasive, plastic scrubbing pad Small brush	<ul style="list-style-type: none"> <li>• Wash, rinse, and dry well.</li> <li>• The wire electrode inside the cap can be cleaned with a small brush.</li> </ul>



## Burner flame

### **⚠️ WARNING**

**Carbon Monoxide Poisoning Hazard**  
**Do not operate with a yellow flame.**  
**Doing so can result in death, heart attack, or convulsions.**

**NOTE:** Occasionally check the burner flames for proper size and shape as shown. A good flame is blue in color. If flames lift off ports, are yellow, or are noisy when turned off, you may need to clean the burners (see page 16), or call a qualified technician for adjustment.

**Flame shape and size**

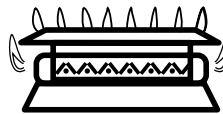
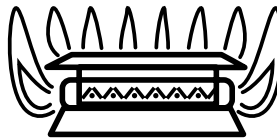

**Setting**

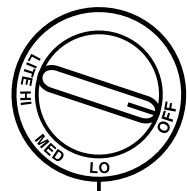
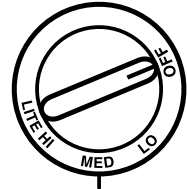
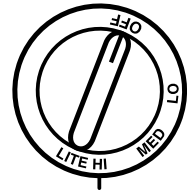

# Grill

## ⚠️ WARNING



### Explosion Hazard

Do not store flammable materials such as gasoline near the cooktop. Doing so can result in death, explosion, fire, or burns.

## ⚠️ WARNING

**Carbon Monoxide Poisoning Hazard**  
Do not operate with a yellow flame. Doing so can result in death, heart attack, or convulsions.

## Installing

The grill is made up of two black grill grates and a grill burner. Only install the grill on the left side of your cooktop. To get the grill accessory, order Part Number SCM20DB from a Whirlpool service company or dealer (see Step 2 on page 33) or call the Whirlpool Consumer Assistance Center toll-free 1-800-253-1301.

### To install:

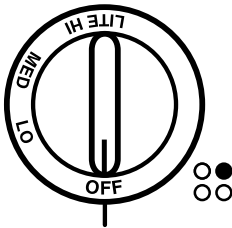

1. **Make sure** the control knobs are turned off.

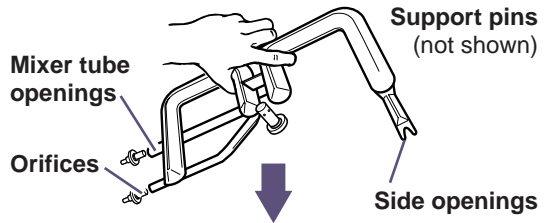

2. **Set** the grill burner accessory into place. Mixer tube openings should be pointed toward the orifices. **Slide** the burner toward the orifices until the ignitor is in between the front and rear grill sections. **Lower** into place until the notches in the side of the burner bracket rest on the burner support pins. Be sure mixer tubes are over the orifices.

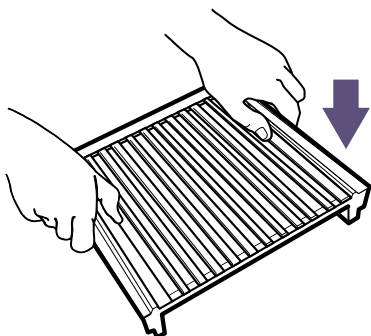

3. Place the grill grates on the top of the cooktop.

---

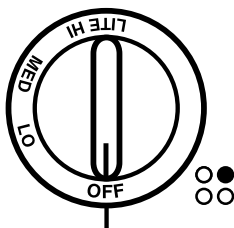
**To remove:**

1. Make sure the control knobs are turned off and the grill is cool.

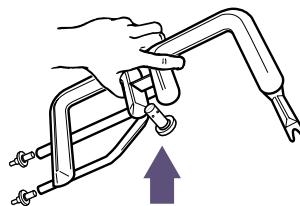

3. Remove grill burner.

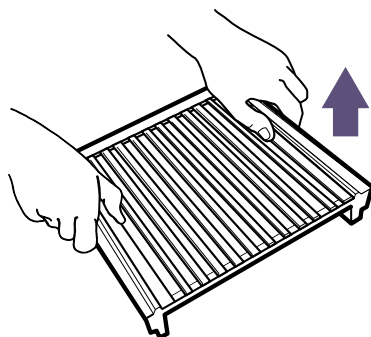

2. Remove grill grates.

## Using

### Before you use the grill for the first time:

1. **Heat** the grill burner to remove the protective shipping coating. Heat on HI for 10 minutes. Use the vent system to remove any additional smoke during cooling. When the grill burner stops smoking, it is ready to use.
2. **Wash** with warm, soapy water. **Rinse and dry.** Never use a metal scrubbing pad or gritty cleanser on the grill; these will damage the nonstick surface.
3. **After cleaning, lightly wipe** the cooking surface with cooking oil. This will prevent the food from sticking.

### Grilling tips

#### Choosing meat

- **For best results,** buy top grade meat. Meat that is at least  $\frac{3}{4}$ " thick will grill better than thinner cuts.

#### Preparing to grill

- **Meat** that usually has a lot of fat will smoke more when cooking and could cause flare-ups. However, fatty meat cooks faster than lean meat. Trim fat from meat before placing on the grill to prevent a large amount of smoke or flare-ups.
- **Remove** the grill cover before heating the grill. Because a heated grill cover would not look hot, someone could be burned if they touched the cover. Heating the grill cover could also damage the finish.
- **Precondition** grates by brushing them with vegetable oil or spraying them with a nonstick coating prior to each use.
- **Score** fat on the edges of steak, but do not cut into the meat. This will prevent curling while cooking.
- **Preheat** the grill on the HI setting for five to 10 minutes. Preheating makes meat taste and look better. It also lets you quickly sear the meat to help keep juices in.

- **The fan switch** turns on by itself while you are using the grill. Do not use the grill if the fan does not go on.
- **Do not cover** the entire cooking surface with meat. Leave space between the food items to help smoke and steam clear away quickly.

#### What to use while grilling

- **Use** tongs with long handles or spatulas for turning meats. Do not use forks because they make holes in the meat, letting juices run out.

#### What not to use in the grill area

- **Do not use** aluminum foil.
- **Do not use** charcoal or wood chips.

#### While cooking

- **Before turning, let** one side of meat cook until it is as done as you want, or cook until juices appear on the top of the meat. Turn steaks and hamburgers just once; turning and moving food causes it to lose juice.
- **When basting** meats or putting sauces on food, remember that extra sauce winds up inside your grill and does not improve the food's flavor. Put on sauces during the last 15-20 minutes of cooking unless the recipe tells you to do it differently. If you put on too much of a sugary sauce, it will leave a caramel-like glaze on the grill grates. This glaze is hard to clean.
- **There are many** meat marinades which will help make less expensive cuts of meat tender for cooking on the grill.
- **Some foods,** such as poultry and nonoily fish, may need some extra fat. Brush with oil or melted butter from time to time while grilling.
- **To help keep** juices in meat, salt after turning meat or after cooking is done.

## Grilling tips (continued)

- **If meat begins** to cook too quickly, turn the grill control knob to a lower setting.
- **Grease drippings** will ignite occasionally to produce harmless puffs of flame for a second or two. This is normal while cooking. If you have too many flare-ups: you need to clean the grill interior, you have not trimmed the meat properly, or there is too much fat in the meat.

## What not to do while cooking

- **Do not leave** the optional grill while it is cooking.

## After grilling

- **Clean** the basin area after each use. Do not allow the burner basin to become overloaded with grease.
- **Do not place** the optional grill cover over a heated grill. Let the grill cool before putting the cover in place.

### NOTES:

- **Do not set** utensils or other items that could cause scratches on the grill cover. Do not set very hot containers on the cover or handles, since these could mar or change the color of the cover.
- **Use** the cover over the grill grates only. Do not place the cover over the griddle or surface burner grates.

## ⚠ WARNING



### Fire Hazard

**Grease can cause large flare-ups.**

**To put out fire:**

**Make sure vent system has been switched on.**

**Turn grill control off, cover grill with large metal pan, and remove food from grill.**

**Do not put water on a grease fire.**

**To prevent fire and burns:**

**Do not light grill/griddle burners during a power failure.**

**Do not use pots or pans on grill. They will become very hot.**

**Failure to follow the above can result in fire or burns.**

### NOTES:

- **The vent system** will not work if there is a power failure. Without the vent system working, the grill/griddle burners will not be kept cool enough.
- **Use only** nylon or plastic utensils. The use of metal utensils could scratch the non-stick coating.
- **When using** nylon or plastic utensils, do not leave them on the grill. They could melt.

## Grill chart

Preheat on HI for 5 or 10 minutes for best flavor. Grilling times are guidelines only and may need to be adjusted to get the taste and/or doneness you want.

FOOD	SETTING	COOKING TIME (in minutes)	COMMENTS
<b>Steak</b> (½-¾")			
• Rare	HI	6-10	Turn after half the time.
• Medium	HI	10-16	Turn after half the time.
• Well-done	HI	21-24	Turn after half the time.
<b>Steak</b> (1-1¼")			
• Rare	HI	14-24	Turn after half the time.
• Medium	HI	18-30	Turn after half the time.
• Well-done	HI	24-34	Turn after half the time.
<b>Hamburgers</b> (3-4 oz)	MED	20-25	Turn after half the time.
<b>Pork chops</b>	MED	20-30	Turn occasionally.
<b>Fully cooked smoked pork chops</b>	MED	10-15	Turn once. Glaze if desired.
<b>Ham slices</b> (½")	MED	15-20	Turn after half the time.
<b>Pork ribs</b>	MED	50-65	Turn occasionally. Brush with barbecue sauce during last 15 minutes.
<b>Fully cooked sausages</b>			
• Hot dogs, brats	HI	7-12	Turn occasionally.
• Polish	HI	13-16	Turn occasionally.
<b>Fresh sausage</b>			
• Links	MED	15-25	Turn occasionally.
• Patties (3" diameter)	MED	15-20	Turn after half the time.
• Italian sausage	MED	25-30	Pierce casing with a fork. Turn once.
<b>Lamb chops</b>	MED	20-30	Turn occasionally. Brush with glaze, if desired.
<b>Chicken</b>			
• Pieces: Bone-in	MED	35-50	Turn occasionally.
• Boneless breasts	MED	25-35	Turn occasionally.
• Wings	MED	25-35	Turn occasionally.
<b>Cornish hen</b> (halved)	MED	35-45	Turn occasionally.

FOOD	SETTING	COOKING TIME (in minutes)	COMMENTS
<b>Fish</b>			
• Small, whole (1")	MED	15-20	Brush with butter. Turn after half the time.
• Steaks (1")	MED	20-25	Brush with butter. Turn after half the time.
• Fillets (½") (with skin on)	MED	10-15	Start skin side down. Brush with butter. Turn after half the time.
• Shrimp (skewered)	MED	10-20	Turn and brush with butter or marinade often.
<b>Garlic bread</b>	MED	4-6	Turn after half the time.
<b>Hot dog and hamburger buns</b>	MED	1-2	Turn after half the time.

## Caring for grill

**NOTE:** Do not use bleach or rust removers to clean any part of the grill.

Cleaning your grill whenever spills or soiling occurs will help to keep it looking and working like new.

PART	WHAT TO USE	HOW TO CLEAN
<b>Grates</b>	Warm, soapy water and a nonabrasive, plastic scrubbing pad <b>OR</b> Dishwasher	<ul style="list-style-type: none"> <li>• Wash, rinse, and dry well.</li> <li>• For heavy soil soak in hot, soapy water mixed with a cleanser, such as household ammonia.</li> </ul> <p><b>NOTE:</b> Do not use metal brushes, abrasive scouring pads, or other scrubbers made to clean outdoor grills. These will remove the finish as well as scratch the grates. Do not clean in a self-cleaning oven or use oven cleaners.</p>
<b>Drain jar</b> (under cooktop)	Warm, soapy water and a sponge or a nonabrasive, plastic scrubbing pad <b>OR</b> Dishwasher	<ul style="list-style-type: none"> <li>• Empty the jar from time to time to prevent spillovers.</li> <li>• Unscrew and remove the jar to empty it. If the jar is broken replace it with any heat-tempered jar, such as a canning jar. The jar should have a standard screw neck.</li> </ul>

continued on next page

## GRILL

PART	WHAT TO USE	HOW TO CLEAN
<b>Grill burner</b>	Warm, soapy water and a nonabrasive, plastic scrubbing pad <b>OR</b> Dishwasher	<ul style="list-style-type: none"><li>• Clean with a soapy, nonabrasive scrubbing pad or in a dishwasher. Rinse and dry well before using again.</li><li>• For heavy soil first clean with pad, rinse, and dry. Then clean in a self-cleaning oven for two hours.</li><li>• If ports are clogged, clean with a straight pin. <b>Do not enlarge or distort ports. Do not use a wooden toothpick.</b></li></ul>
<b>Cover</b>	Warm, soapy water and a sponge	<ul style="list-style-type: none"><li>• Wash, rinse, and dry well.</li><li>• <b>Do not clean in a dishwasher.</b></li></ul>
<b>Area under grill burner</b>	Warm, soapy water and a sponge or nonabrasive, plastic scrubbing pad <b>OR</b> Paper towels and household cleanser	<ul style="list-style-type: none"><li>• Wash, wipe with clean water, and dry well.</li><li>• Use nonabrasive, plastic scrubbing pad on heavily soiled areas.</li><li>• <b>Do not use gritty or harsh cleansers. They may damage the finish.</b></li><li>• For heavy soil, soak paper towels in household cleanser and lay them on the soil for at least ½ hour or longer.</li></ul>



# Griddle

## ⚠️ WARNING



### Explosion Hazard

Do not store flammable materials such as gasoline near the cooktop.

Doing so can result in death, explosion, fire, or burns.

## ⚠️ WARNING

### Carbon Monoxide Poisoning Hazard

Do not operate with a yellow flame.

Doing so can result in death, heart attack, or convulsions.

## Installing

You can install a griddle accessory on the left side of your cooktop. To use this accessory you must have grill accessory Part Number SCM20DB. To get the griddle accessory, order Part Number SCM40DB from a Whirlpool service company or dealer (see Step 2 on page 33) or call the Whirlpool Consumer Assistance Center toll-free 1-800-253-1301.

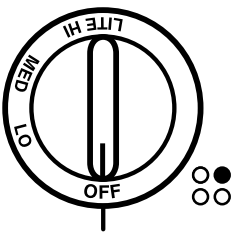

1. **Make sure** the grill burner is installed and the control knobs are turned off.

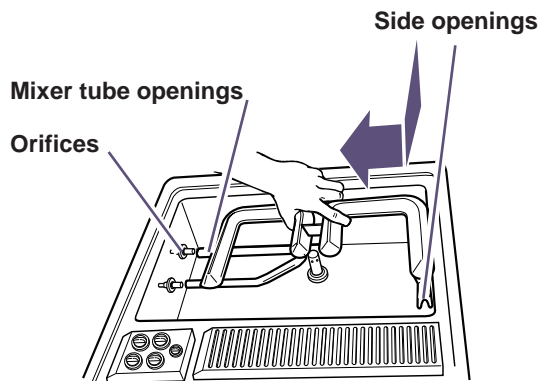

2. If grill burner is not installed, set the grill burner into place. Mixer tube openings should be pointed toward the orifices. **Slide** the burner toward the orifices until the ignitor is in between the front and rear grill sections. **Lower** into place until the notches in the side of the burner bracket rest on the burner support pins.

**NOTE:** Do not use the grill grates.

# GRIDDLE

Drain groove

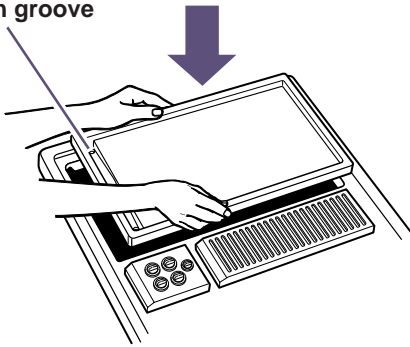

3. Place the griddle over the grill burner so that the drain groove is in front. This will let extra grease collect in the drain jar.

## Using

### Before using the griddle for the first time:

1. Wash griddle in warm, soapy water. Rinse and dry well.
2. Preheat griddle for five minutes at the settings shown in the "Griddle chart" on this page.
3. After preheating, lightly wipe the top of the griddle with cooking oil. This prevents sticking. Do not use shortening or butter to grease the griddle.

**NOTE:** Do not preheat a seasoned griddle. If the griddle is seasoned during preheat, oil changes its chemical composition and forms a varnish-like finish, which is difficult to remove.

### Griddling tips

- Place food right on the cooking surface of the griddle.
- Turn off the grill burner when cooking is finished. Leaving the burner on will damage the griddle.
- Do not use cookware on the griddle. Use only plastic or nylon kitchen utensils on the griddle. Metal could damage the nonstick cooking surface.

## ! WARNING



### Fire Hazard

Be sure the griddle control is off and the griddle is cool when not in use.

Failure to do so can result in fire or burns.

## Griddle chart

Preheat for five minutes at the setting listed below. Griddling times are guidelines only and may need to be adjusted to get the taste and/or doneness you want.

FOOD	CONTROL SETTING	APPROXIMATE COOKING TIME (in minutes)	
		FIRST SIDE	SECOND SIDE
<b>Sausage patties</b>	MED	6	4
<b>Bacon (slice)</b>	MED	4-5	3-4
<b>Ham slice</b>	MED	6-7	5-6
<b>Hamburgers</b>	HI	5	4
<b>Fish sticks (frozen)</b>	MED	9	9
<b>Hot dogs</b>	HI	5	5
<b>Buns</b>	MED	3-4	
<b>French toast</b>	HI	3-4	2-3
<b>Grilled cheese sandwiches</b>	HI	2	2
<b>Pancakes</b>	HI	1-2	1-2
<b>Eggs</b>	MED	2	1 or less

## Caring for griddle

You must clean your griddle after each use to keep the finish in good shape.

PART	WHAT TO USE	HOW TO CLEAN
<b>Griddle</b>	Warm, soapy water and a nonabrasive, plastic scrubbing pad	<ul style="list-style-type: none"> <li>• Wash once griddle has cooled. Do not put a hot griddle in cold water.</li> <li>• For heavy soil, use a nonabrasive scrubbing pad.</li> </ul> <p><b>NOTE:</b> Do not wash in a dishwasher. Strong detergents can remove some of the nonstick finish.</p>
<b>Grill Burner</b>	Warm, soapy water and a sponge <b>OR</b> Dishwasher	<ul style="list-style-type: none"> <li>• Clean with a soapy, nonabrasive scrubbing pad or in a dishwasher. Rinse and dry well before using again.</li> <li>• For heavy soil, first clean with pad, rinse, and dry. Then clean in a self-cleaning oven for two hours.</li> <li>• If ports are clogged, clean with a straight pin. <b>Do not enlarge or distort ports. Do not use a wooden toothpick.</b></li> </ul>
<b>Area under grill burner</b>	Warm, soapy water and a sponge <b>OR</b> Paper towels and household cleanser	<ul style="list-style-type: none"> <li>• Wash, wipe with clean water, and dry well.</li> <li>• Use nonabrasive, plastic scrubbing pad on heavily soiled areas.</li> <li>• <b>Do not use gritty or harsh cleansers. They may damage the finish.</b></li> <li>• For heavy soil, soak paper towels in household cleanser and lay them on the soil for at least ½ hour or longer.</li> </ul>

# Vent

## Using

The built-in vent system removes cooking vapors, odors, and smoke from foods prepared on the cooktop, grill, and griddle. The vent system will go on by itself when the grill burner is being used.

### To turn on the vent system yourself:

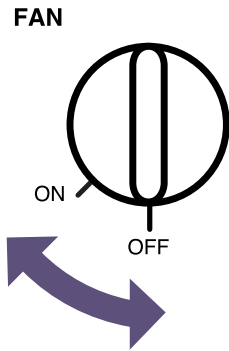

- **Turn** the fan knob in front of the air grille to ON.
- **You can manually** control the vent fan only when using the surface burners. You cannot manually control the vent fan while you are using the grill or griddle.
- **If the vent fan** turns on automatically, it will turn off automatically when you turn off the grill or griddle. If you turn the vent fan on manually, you will need to shut it off manually.

<b>! WARNING</b>	
	
<b>Cut Hazard</b>	
Do not put hands into vent when fan or controls are on.	
Doing so can result in serious cuts.	

## Caring for vent

### ⚠ WARNING



**Electrical Shock Hazard**  
 Disconnect the electrical supply before servicing the cooktop.  
 Turn fan and cooktop controls off before cleaning the vent system.  
 Do not put hand in vent box when fan or controls are on.  
 Failure to follow these instructions can result in death, electrical shock, or other serious injury.

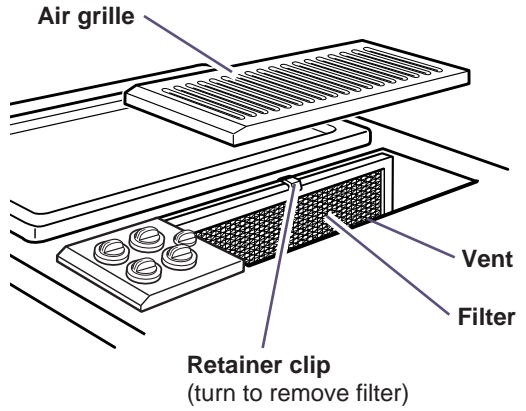

**NOTES:**

- **The wall receptacle** is located in the cabinet beneath the cooktop.
- **The vent fan system** turns on by itself when the grill or griddle is used.

To keep your vent system working well, clean it regularly using the chart below.

PART	WHAT TO USE	HOW TO CLEAN
<b>Air grille</b>	Warm, soapy water and a sponge <b>OR</b> Dishwasher	<ul style="list-style-type: none"> <li>• Wash, rinse, and dry well.</li> </ul>
<b>Filter</b>	Warm, soapy water and a sponge <b>OR</b> Dishwasher	<ul style="list-style-type: none"> <li>• Clean in sink or dishwasher when soiled.</li> </ul> <p><b>NOTE:</b> Do not run the ventilation system without the filter. As you face the front of the cooktop, the top of the filter should rest against the left side of the vent opening and the bottom of the filter should rest against the right side of the ventilation chamber at the bottom. If the filter is flat against the fan wall, ventilation effectiveness is reduced.</p>
<b>Vent</b>	Warm, soapy water and a sponge <b>OR</b> Spray glass cleaner and a paper towel	<ul style="list-style-type: none"> <li>• Clean whenever the chamber becomes soiled.</li> </ul>

# Troubleshooting

Most cooking problems often are caused by little things you can find and fix without tools of any kind. Check the lists below and on the next page before calling for assistance or service. If you still need help, see “Requesting Assistance or Service” on page 33.

## If nothing operates, check the following:

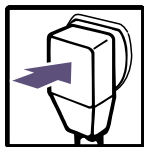

Is the cooktop properly connected to gas and electrical supplies?  
(See Installation Instructions.)

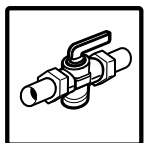

Have you blown a household fuse or tripped a circuit breaker?

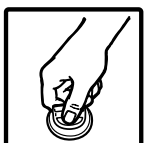

Is the control knob set correctly?



Is the flow of combustion and/or ventilation air to the cooktop blocked?



## Other possible problems and their causes:

PROBLEM	CAUSE
<b>Burner fails to light</b>	<ul style="list-style-type: none"> <li>• Cooktop is not wired into a live circuit with the proper voltage.</li> <li>• You have blown a household fuse or tripped a circuit breaker.</li> <li>• Burner ports are clogged. Clean with a straight pin. (See pages 17, 24, and 28.)</li> </ul>
<b>Burner flames are uneven</b>	<ul style="list-style-type: none"> <li>• Burner ports are clogged. Clean with a straight pin. (See pages 17, 24, and 28.)</li> <li>• Flame setting may need to be adjusted.</li> </ul>

continued on next page

## TROUBLESHOOTING

PROBLEM	CAUSE
<b>Burner flames lift off ports, are yellow, or are noisy when turned off</b>	<ul style="list-style-type: none"> <li>• Air/gas mixture is incorrect. Contact an authorized Whirlpool service technician to check air/gas mixture.</li> </ul>
<b>Burner makes popping noise when on</b>	<ul style="list-style-type: none"> <li>• Burner is wet from washing. Let dry.</li> </ul>
<b>Grill does not work properly</b>	<ul style="list-style-type: none"> <li>• You have not left space between food items.</li> <li>• You have not preheated the grill for the proper amount of time.</li> <li>• Food was partially frozen or very cold before grilling. This will make cooking time longer.</li> </ul>
<b>Control knob(s) will not turn</b>	<ul style="list-style-type: none"> <li>• You are not pushing in before turning.</li> </ul>
<b>Venting results are not what you expected</b>	<ul style="list-style-type: none"> <li>• Exhaust fan is not turned on.</li> <li>• Vent filters are not clean or are not in place.</li> <li>• Vent duct or outside opening is blocked.</li> <li>• There is a draft in room where cooktop is installed.</li> <li>• Meat is not well trimmed.</li> <li>• Vent system has not been installed according to the Installation Instructions.</li> </ul>
<b>Cooking results are not what you expected</b>	<ul style="list-style-type: none"> <li>• The cooktop is not level.</li> <li>• The recipe you are using may need to be altered to improve the taste or appearance of the food.</li> <li>• You are using a pan that is not the correct type or size. Refer to a reliable cookbook or recipe for recommended pan type and size.</li> <li>• The flame size does not fit the cooking utensil being used.</li> </ul>

If none of these items was causing your problem, see “Requesting Assistance or Service” on page 33.



# Requesting Assistance or Service

Before calling for assistance or service, please check “Troubleshooting” on pages 31-32. It may save you the cost of a service call. If you still need help, follow the instructions below.

## 1. If you need assistance\* ...

Call the Whirlpool Consumer Assistance Center telephone number. Dial toll-free from anywhere in the U.S.A.:



**1-800-253-1301**

and talk with one of our trained consultants. The consultant can instruct you in how to obtain satisfactory operation from your appliance or, if service is necessary, recommend a qualified service company in your area.

If you prefer, write to:

Whirlpool Brand Home Appliances  
Consumer Assistance Center  
c/o Correspondence Dept.  
414 N. Peters Rd.  
Knoxville, TN 37922

Please include a daytime phone number in your correspondence.

## 2. If you need service\* ...

Whirlpool has a nationwide network of authorized Whirlpool service companies. Whirlpool service technicians are trained to fulfill the product warranty and provide after-warranty service, anywhere in the United States. To locate the authorized Whirlpool service company in your area, call our Consumer Assistance Center telephone number (see Step 1) or look in your telephone directory Yellow Pages under:



• **APPLIANCE-HOUSEHOLD-MAJOR, SERVICE & REPAIR**  
- See: Whirlpool Appliances or Authorized Whirlpool Service  
(Example: XYZ Service Co.)

• **WASHING MACHINES & DRYERS, SERVICE & REPAIR**  
- See: Whirlpool Appliances or Authorized Whirlpool Service  
(Example: XYZ Service Co.)

## 3. If you need FSP® replacement parts ...

FSP is a registered trademark of Whirlpool Corporation for quality parts. Look for this symbol of quality whenever you need a replacement part for your WHIRLPOOL® appliance. FSP replacement parts will fit right and work right, because they are made to the same exacting specifications used to build every new WHIRLPOOL appliance.

To locate FSP replacement parts in your area, refer to Step 2 or call the Whirlpool Consumer Assistance Center number in Step 1.

## 4. If you are not satisfied with how the problem was solved ...

- Contact the Major Appliance Consumer Action Program (MACAP). MACAP is a group of independent consumer experts that voices consumer views at the highest levels of the major appliance industry.
- Contact MACAP only when the dealer, authorized servicer, and Whirlpool have failed to resolve your problem.
  - Major Appliance Consumer Action Program  
20 North Wacker Drive  
Chicago, IL 60606
- MACAP will in turn inform us of your action.

### \* When asking for help or service:

Please provide a detailed description of the problem, your appliance's complete model and serial numbers, and the purchase date. (See page 2.) This information will help us respond properly to your request.

# WHIRLPOOL® Gas Cooktop Warranty

LENGTH OF WARRANTY	WHIRLPOOL WILL PAY FOR
<b>FULL ONE-YEAR WARRANTY</b> From Date of Purchase	FSP® replacement parts and repair labor to correct defects in materials or workmanship. Service must be provided by an authorized Whirlpool service company.
<b>WHIRLPOOL WILL NOT PAY FOR</b>	
<p><b>A.</b> Service calls to:</p> <ol style="list-style-type: none"> <li>1. Correct the installation of your cooktop.</li> <li>2. Instruct you how to use your cooktop.</li> <li>3. Replace house fuses or correct house wiring or plumbing.</li> </ol> <p><b>B.</b> Repairs when your cooktop is used in other than normal, single-family household use.</p> <p><b>C.</b> Pickup and delivery. Your cooktop is designed to be repaired in the home.</p> <p><b>D.</b> Damage to your cooktop caused by accident, misuse, fire, flood, acts of God, or use of products not approved by Whirlpool.</p> <p><b>E.</b> Repairs to parts or systems caused by unauthorized modifications made to the appliance.</p>	

7/95

WHIRLPOOL CORPORATION SHALL NOT BE LIABLE FOR INCIDENTAL OR CONSEQUENTIAL DAMAGES. Some states do not allow the exclusion or limitation of incidental or consequential damages, so this exclusion or limitation may not apply to you. This warranty gives you specific legal rights, and you may also have other rights which vary from state to state.

**Outside the United States, a different warranty may apply. For details, please contact your authorized Whirlpool dealer.**

If you need service, first see the "Troubleshooting" section of this book. After checking "Troubleshooting," additional help can be found by checking the "Requesting Assistance or Service" section, or by calling our Consumer Assistance Center telephone number, **1-800-253-1301**, from anywhere in the U.S.A.