

ROOM AIR CONDITIONER

Use & Care Guide

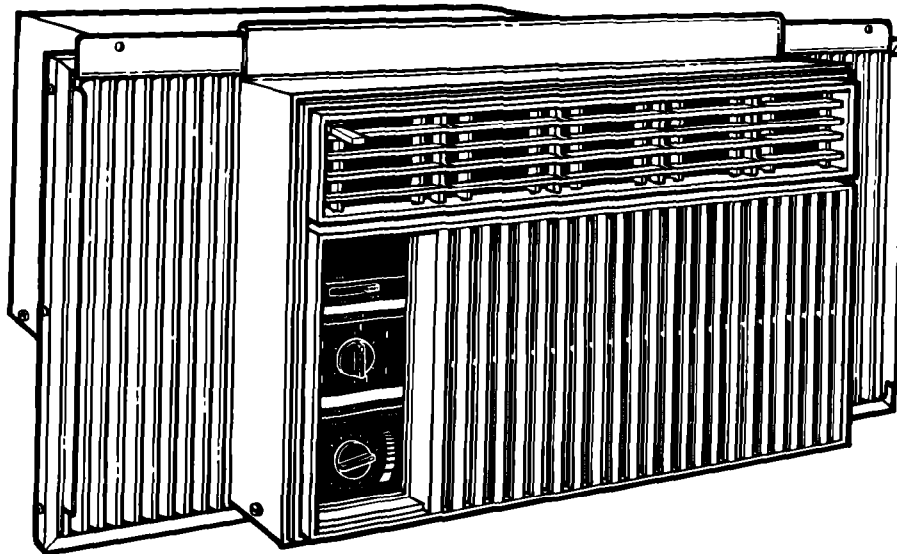

Mx

Contents

	Page
Important Safety Instructions	2
Operating Instructions	3
Starting your air conditioner	3
The exhaust control	3
The ENERGY SAVER settings	4
Changing air direction	4
Cleaning Your Air Conditioner	5
Cleaning front panel and filter	5
Caring For Your Air Conditioner	6
Annual maintenance	6
Oiling the fan motor	7
Energy saving tips	7
If You Need Service Or Assistance	8

Thank you for buying this appliance. Please complete the form below. Have this information ready if you need service or call with a question.

- Copy model and serial numbers from label (see diagram below) and purchase date from sales slip.
- Keep this book and sales slip together in a handy place.

Model Number

Serial Number

Purchase Date

Service Company Phone Number

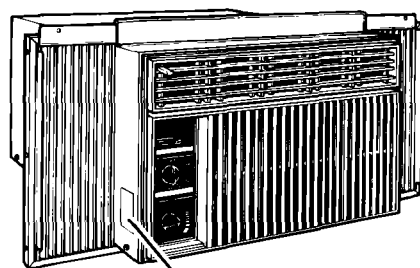

Model and serial number label

Important Safety Instructions

⚠ WARNING

To reduce the risk of fire, electrical shock or personal injury when using your air conditioner, follow these basic precautions:

- Read all instructions before using air conditioner.
- Complete the installation requirements as described in the Installation Instructions.
- Do Not operate the air conditioner with the front panel removed.
- Never clean air conditioner parts with flammable fluids. The fumes can create a fire hazard or explosion.

• FOR YOUR SAFETY •

DO NOT STORE OR USE GASOLINE OR OTHER FLAMMABLE VAPORS AND LIQUIDS IN THE VICINITY OF THIS OR ANY OTHER APPLIANCE. THE FUMES CAN CREATE A FIRE HAZARD OR EXPLOSION.

It is your responsibility to be sure your air conditioner:

- Is installed in a window that will hold the weight, and is secured according to the Installation Instructions.
- Is connected only to the proper kind of outlet, with the correct electrical supply and grounding. (See Installation Instructions.)
- Is the correct size for the area you want to cool.
- Is used only to do what window air conditioners are designed to do.
- Is not used by anyone unable to operate it properly.
- Is properly maintained.

Also, remove Energy Label and Buy Guide. Use a damp cloth to take off any glue residue. Do not use sharp instruments, flammable fluids or abrasive cleaners. These can damage the material.

- SAVE THESE INSTRUCTIONS -

Operating Instructions

Starting your air conditioner

⚠ WARNING

Electrical Shock Hazard

- Plug unit only into grounded electrical outlet.
 - Do not use an extension cord.
 - Do not operate unit with front removed.
- Failure to follow the above precautions could result in electrical shock or personal injury.

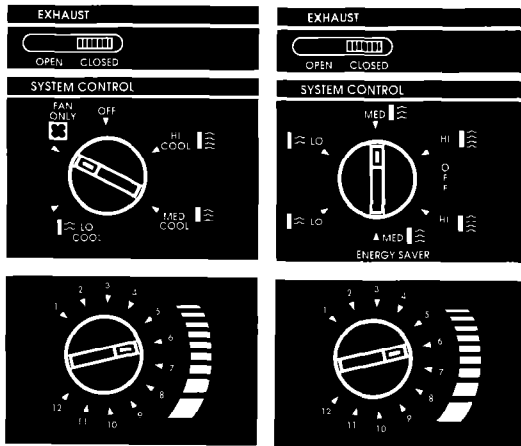

1. Set Exhaust Control (on some models) to CLOSED for maximum cooling.
2. Set System Control to the desired setting.

LO COOL (LO) for sleeping comfort
MED COOL (MED) * for normal cooling
HI COOL (HI) for maximum cooling
FAN ONLY* for circulating room air when no cooling is desired

*on some models

3. Turn the Thermostat Control to the mid-setting. You can adjust the air conditioner's cooling performance by resetting the Thermostat Control to a higher number for maximum cooling. Lower the number setting for less cooling. You will need to experiment to find the setting which suits you best.

NOTE: If you turn your air conditioner off or if the compressor turns off when lowering the Thermostat Control, wait at least 3 minutes before turning it back on or you may blow a fuse or trip a circuit breaker.

The exhaust control (on some models)

The Exhaust Control setting draws stale or smoky air from the room.

1. To exhaust room air:

- Set Exhaust Control to OPEN.
- For cooling, set System Control to desired fan speed.
- If no cooling is desired, set System Control to FAN ONLY (on some models).

If there is no FAN ONLY setting, select a fan speed setting and set Thermostat Control to its lowest setting. Be sure to reset Thermostat Control when cooling action is desired.

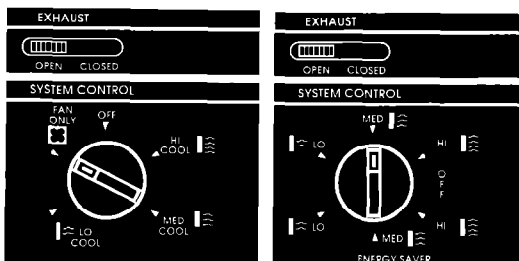

Operating Instructions Continued

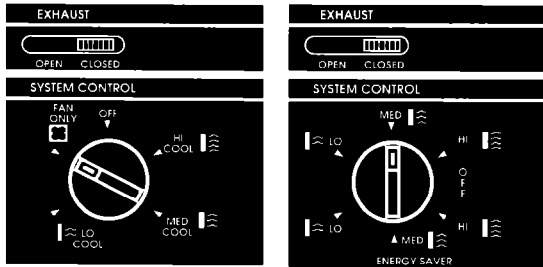

2. To circulate room air:

- Set Exhaust Control to CLOSED.
- For cooling, set System Control to desired fan speed.
- If no cooling is desired, set System Control to FAN ONLY (on some models).
If there is no FAN ONLY setting, select a fan speed setting and set Thermostat Control to its lowest setting. Be sure to reset Thermostat Control when cooling action is desired.

NOTE: For maximum performance, the Exhaust Control must be in the CLOSED position when cooling, or room air circulation is desired.

System control

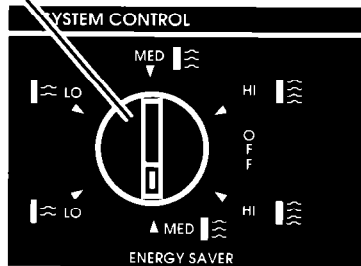

The ENERGY SAVER settings (on some models)

The ENERGY SAVER settings are the three settings to the bottom of the System Control (HI, MED and LO). These settings save energy. The fan will cycle on and off as the Thermostat Control turns the compressor on and off. This saves the cost of electrical energy that would be used to run the fan continuously.

It is normal for the fan to turn on and off in the ENERGY SAVER settings. The amount of time the unit will be off depends on the room temperature and Thermostat Control setting.

Changing air direction

The louvers, in the top grille area of the air conditioner, control the direction of the cooled air. Move the tab, at the top of the louvered area, in the direction you want the air to go (right, left or straight ahead).

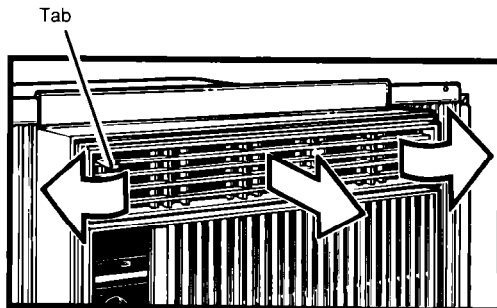

Cleaning Your Air Conditioner

Proper use and care of your air conditioner will help ensure longer life of the unit and lower operating costs. Follow these instructions carefully. Call your authorized servicing dealer for an annual checkup.

Cleaning front panel and filter

⚠ WARNING

Electrical Shock, Personal Injury and Product Damage Hazard

- **Unplug power cord from receptacle before cleaning unit. Failure to do so could result in electrical shock or personal injury.**
- **Handle the air conditioner with care. The metal fins on the coils are sharp. Failure to do so could result in personal injury.**
- **Do not use cleaning fluids, solvents, abrasive cleaners, or strong detergents. They may damage the parts.**

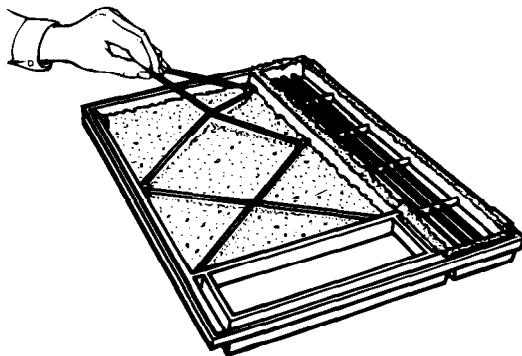
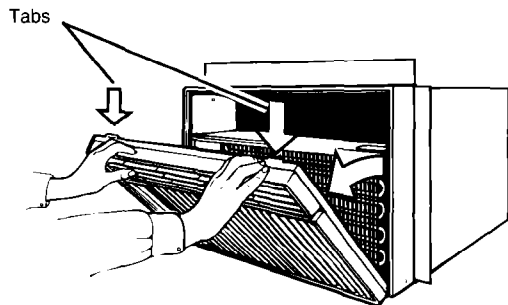

1. Unplug power cord.
2. Remove the front panel from unit for cleaning. Press down at top of front panel to release it from top of cabinet.
3. Pull top of front panel toward you.
4. Lift up and away from bottom spring clips.
5. Remove filter from front panel by removing elastic band which holds it in place.
6. Clean filter by using a vacuum cleaner or, if very dirty, wash filter with warm water and a mild detergent. Air dry thoroughly before replacing. **Do not use a hot air dryer on filter.**
7. Clean front panel using a soft cloth with warm water and a mild detergent. Rinse and dry.
8. Replace filter and hold it in place with elastic band.
9. Wipe control panel clean with a soft dry cloth.
10. Replace front panel. Locate bottom of panel on the spring clips. Press down on top edge of front panel and push front toward unit to secure upper tabs.
11. Reconnect power supply.

Caring For Your Air Conditioner

Annual maintenance

Your air conditioner needs annual maintenance to help ensure steady, top performance throughout the year.

Call the service company recommended by your dealer to:

- Inspect and clean the coils and condensate water passages.
- Check fan and oil the fan motor.

The compressor is sealed and needs no oiling. Expense of annual inspection is the customer's responsibility.

OR

If you are familiar with electrical appliances, you can do the inspection and maintenance yourself. If you choose to do so, follow these steps:

⚠ WARNING

Electrical Shock, Product Damage and Personal Injury Hazard

- **Unplug power cord from receptacle before performing any maintenance. Be sure no liquid gets into the motor, electrical control box or compressor electrical terminals.**
- **Do not lift, push or pull any white beaded foam (expanded polystyrene) parts.**
- **Because your air conditioner weighs from 80 to 110 pounds, it is recommended that you have someone help you when you remove and re-install your unit and that you both use proper lifting techniques.**
- **Handle the air conditioner with care. Watch out for the sharp metal fins on the front and rear condenser coils.**
- **Do not use the collected water for drinking purposes. It is not sanitary.**

Failure to follow the above precautions could result in electrical shock, product damage or personal injury.

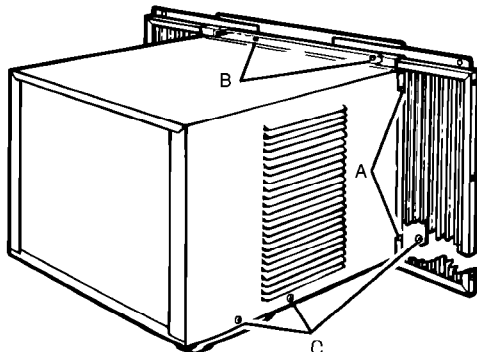

1. Unplug power cord.
2. Remove the front panel. (See "Cleaning front panel and filter" on page 5.)
3. Remove unit from window.
4. Remove side curtains. Slide curtains out to fullest width. From the back side, remove the phillips-head screws which attach the curtains to the cabinet. (See A in illustration at left.)
5. Remove slotted-hex head screws holding top channel. (See B in illustration at left.)
6. Remove slotted-hex head screws on sides of cabinet. (See C in illustration at left.)
7. Holding the cabinet on both sides, carefully lift cabinet off unit base.
8. Wrap the motor, electrical control box and compressor terminal box in plastic film to make sure no water or other liquid gets inside. Water or other liquids could damage insulation and cause serious mechanical problems.
9. Clean and hose out the base, coils and condensate pans. Clean at least once a year, or more often if the condenser coils and pans collect dirt, sand, leaves, insects or algae. Also, clean if you detect an odor coming from the air conditioner.
NOTE: A good time to oil the fan motor is when you already have the cabinet open. See "Oiling the fan motor" on page 7.
10. Remove plastic film from motor and electrical parts.
11. Replace unit in cabinet. Reattach top channel and side curtains.
12. Reinstall unit in window.
13. Replace front panel.
14. Plug in power cord.

NOTE: It is a good idea to wait 24 hours before starting the unit again. This allows time for all areas to dry thoroughly. The water from rainfall or from normal operation does not harm these components.

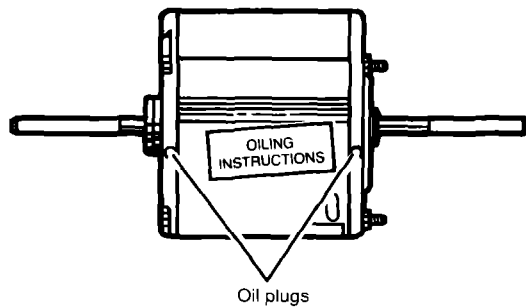

Oiling the fan motor

⚠ WARNING

Electrical Shock Hazard
Unplug power cord from receptacle before oiling fan motor. Failure to do so could result in electrical shock.

1. Unplug power cord.
2. Remove unit from cabinet. (See steps 1-7 in "Annual maintenance" on page 6.)
3. Oil the fan motor according to instructions on the motor. To add oil, remove the oil hole plug at each end of the motor. Oil with SAE #20 non-detergent oil.
4. Replace the plugs to keep dirt from motor bearings.
5. Replace unit in cabinet.
6. Plug in power cord.

Energy saving tips

- Improve home insulation. Seal doors and windows. Close fireplace flue.
- Close blinds or drapes on sunny side of house. Add window awnings.
- Keep air filter clean.
- Do not block air flow with drapes or furniture.
- Ventilate attic. High temperatures in the attic add to the cooling load.
- Try not to use heat-producing appliances during the hottest part of the day.
- Turn lights and appliances off when not needed.
- Keep heat registers and cool-air returns closed.
- Use exhaust venting fans while cooking, doing laundry and bathing.

If You Need Service Or Assistance

Before you call for service...

If you are having an operating problem, check the chart to see what the cause might be before you call for assistance.

PROBLEM	CHECK IF	WHAT TO DO
Unit won't run.	<ul style="list-style-type: none"> • Power cord is plugged into a live circuit with proper voltage. • Fuse has blown or circuit breaker has tripped. Also, check if a time-delay fuse has been used. • System Control is set to OFF. • Local power has failed 	<ul style="list-style-type: none"> • Firmly plug power cord into electrical outlet. Check circuit voltage at fuse/circuit breaker box. • Replace fuse with a time-delay fuse of the correct capacity. Reset circuit breaker. • Set System Control to another setting. • Wait for power to be restored.
Unit blows fuses or trips circuit breaker.	<ul style="list-style-type: none"> • Time-delay fuse being used is of correct capacity. • An extension cord is being used. • Cooling circuit was turned off and on again quickly. 	<ul style="list-style-type: none"> • Replace fuse with a time-delay fuse of the correct capacity. • Do not use an extension cord with this or any other appliance. • Wait at least 3 minutes after turning cooling circuit off before trying to restart unit.
Unit turns on and off, or does not cool room.	<ul style="list-style-type: none"> • Filter is dirty. • Evaporator coils (inside) and condenser coils (outside) are dirty. • There is excessive heat or moisture in room. • Fan speed is too low. • Thermostat setting is too low. 	<ul style="list-style-type: none"> • Clean filter. (See page 5.) • Clean coils. (See page 6.) • Use exhaust fans to reduce room heat, or set Exhaust Control (on some models) to CLOSED to reduce moisture. • Set System Control to a higher setting. • Set Thermostat Control to a higher number.

Normal operating sounds...

When your room air conditioner is **operating normally**, you will hear sounds such as:

- Droplets of water hitting the condenser, causing a "pinging" or "clicking" sound. Water droplets help to cool the condenser.
- Air movement from the fan, especially on high fan speed settings.
- Clicks from the cooling cycle.

Sounds also may be caused by house construction – such as vibration of the unit due to wall construction or unsteady window mounting area.

If you need service...

Call your dealer or the service company recommended by your dealer.