

Installation Instructions for W10323246 4-Way Vent Kit

Front Load Dryer Match with Full Front Panel - Side and Bottom Exhaust Venting

Parts included in Kit:

- 1 Instruction Sheet
- 1 4" Diameter Vent – 305 mm (12")
- 1 4" Diameter Vent – 187 mm (7.40")
- 1 4" Diameter Vent – 86 mm (3.40")
- 1 4" Diameter Vent – Elbow (0 degrees to 90 degrees)
- 2 4 3/16" Diameter Clamp
- 2 Plate, Cover (Metal)
- 2 Plugs, Side Panel (Plastic)
- 1 Ring, Vent
- 2 Screw - #8 x 1/2"

Tool and Accessories required:

- 1/4" Socket and Ratchet Wrench
- 1/4" Nut Driver
- 5/16" Nut-Driver
- Flat-Head Screwdriver
- Phillips-Head Screwdriver
- Hammer
- Pliers
- 1/8" Drill Bit
- Drill
- Cold Chisel
- File, Round

Procedure for Dryer Disassembly

To Gain Access to Inside of Dryer for Installation of Optional Exhaust Venting

⚠ WARNING	
	Electrical Shock Hazard
	Disconnect power before servicing. Replace all parts and panels before operating.
	Failure to do so can result in death or electrical shock.

1. Unplug dryer or disconnect power.

NOTE: For Gas Dryer application, turn off gas supply using the shut-off valve that supplies the dryer. Disconnect flexible gas supply line connected to rear of dryer.

2. Remove dryer top by first removing the two (2) screws from the rear of the dryer. See *Figure 1*.

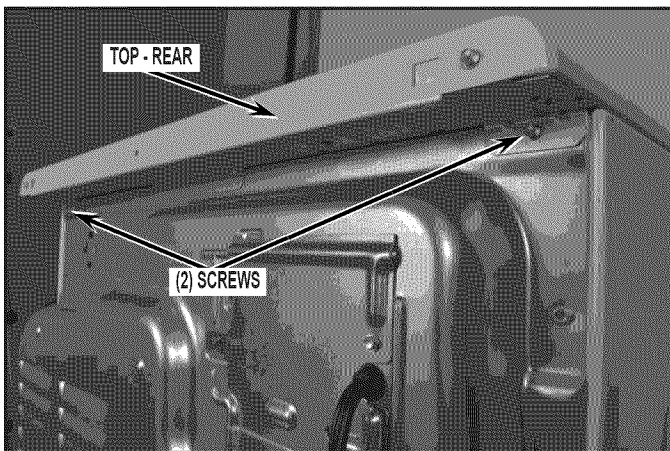

FIGURE 1

3. Remove dryer top by sliding top toward rear of dryer and lift to remove. See *Figure 2*.

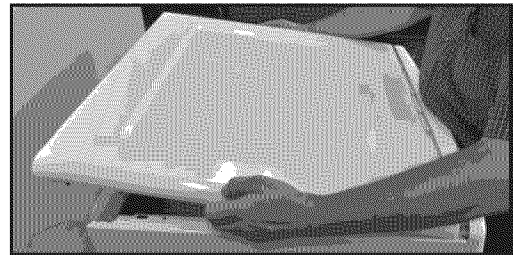

FIGURE 2

4. Remove console by first removing two (2) screws (one from each side of console) at location as shown in *Figure 3*.

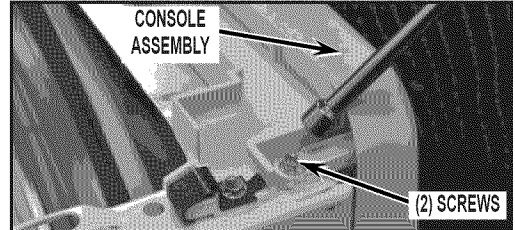

FIGURE 3

NOTE: This kit is used on models with different configurations of main console connector and drum light connectors.

5. Disconnect drum light and main console connectors as shown in *Figure 4A* located on the top right front side of dryer or *Figure 4B* top left front side of dryer. Lift up on console and tilt assembly forward to remove console.

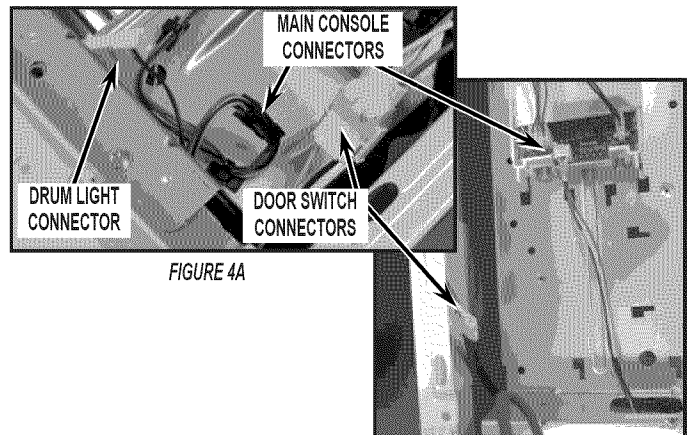

FIGURE 4A

FIGURE 4B

(continued)

- Begin removing front panel assembly by opening door and removing the two (2) screws shown in *Figure 5*.

NOTE: After removal of these screws, close door.

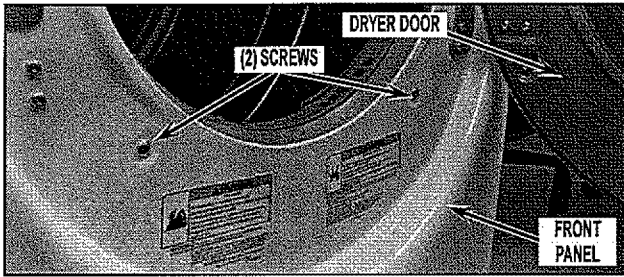

FIGURE 5

- Disconnect door switch connector located on top right front side of dryer. See *Figure 4*.
- Remove four (4) screws from bottom of front panel as shown in *Figure 6*.

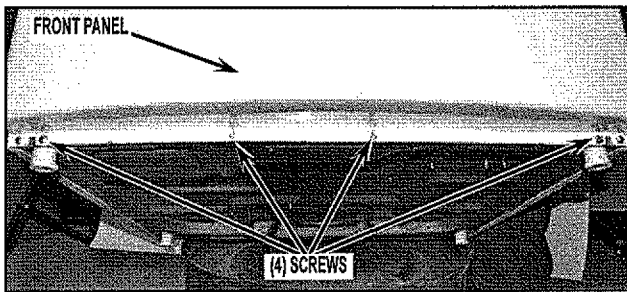

FIGURE 6

- Remove the three (3) screws from the top of the front panel as shown in *Figure 7*.

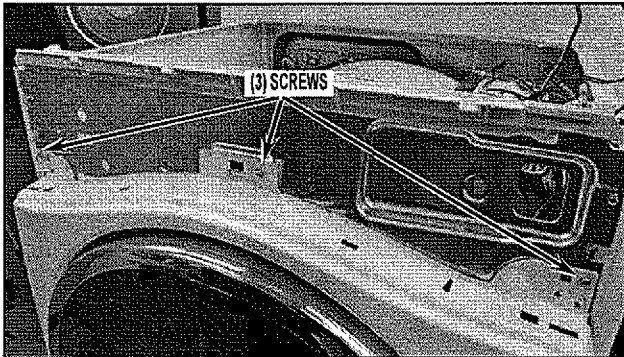

FIGURE 7

- Remove front panel assembly from dryer by lifting front panel assembly off tabs (one each side). See *Figure 8*.

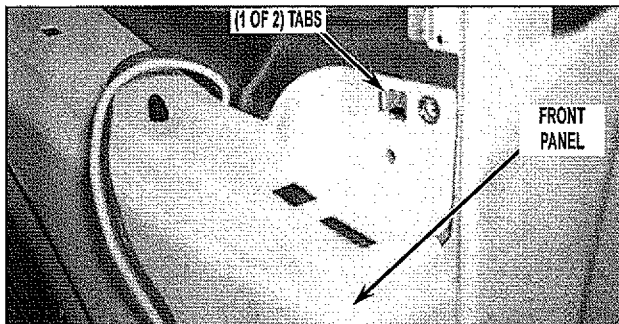

FIGURE 8

- Remove the bulkhead assembly from dryer by first removing lint screen from dryer lint duct. See *Figure 9*.

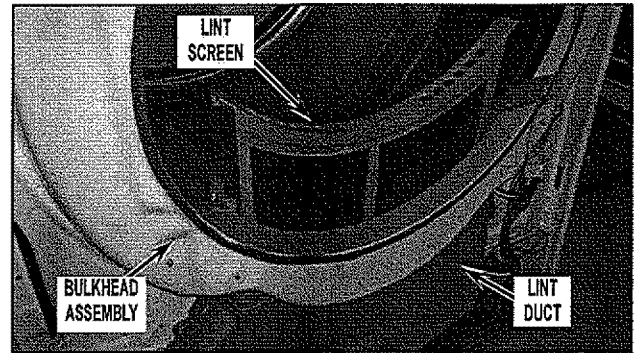

FIGURE 9

- Disconnect moisture sensor disconnect block from main harness disconnect block located at lower right side of dryer. See *Figure 10*.

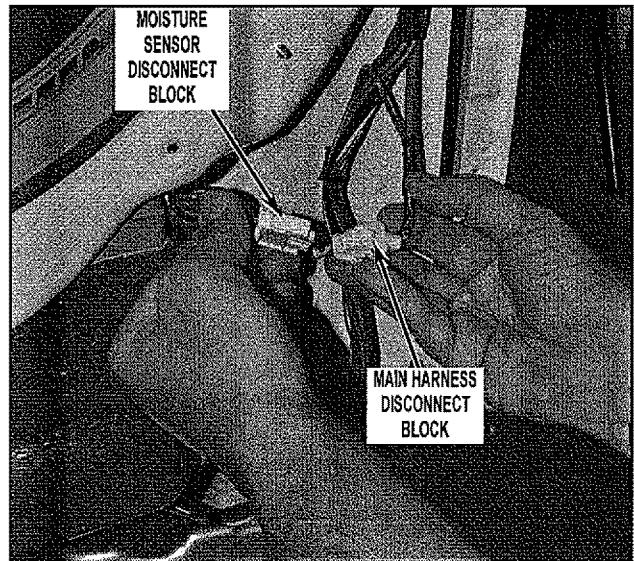

FIGURE 10

- Remove lint duct by removing four (4) screws and clip as shown in *Figure 11*.

NOTE: Slide lint duct down and away from dryer to remove.

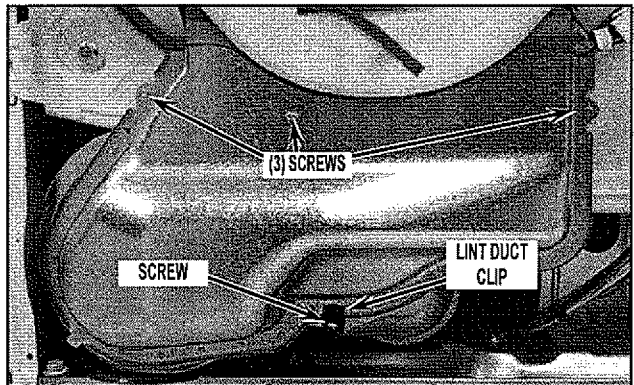

FIGURE 11

14. Remove console mounting bracket by removing two (2) screws securing bracket to cabinet left side panels, two (2) screws from right side panel and one (1) screw from central control bracket. Slightly lift assembly and remove from dryer. See Figure 12A and 12B.

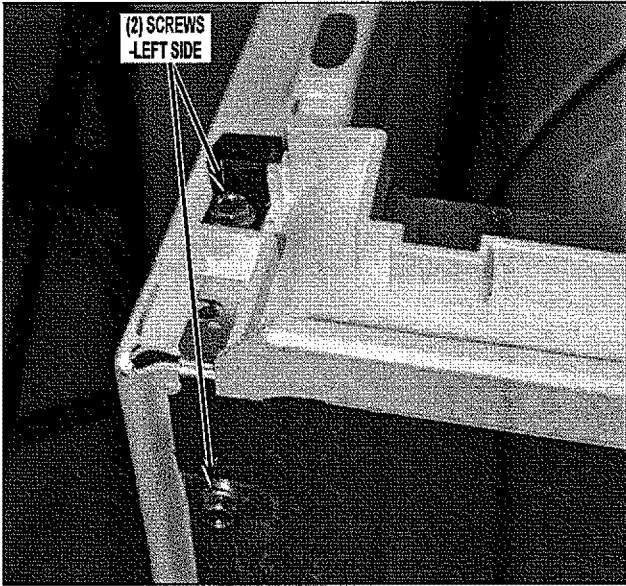

FIGURE 12A

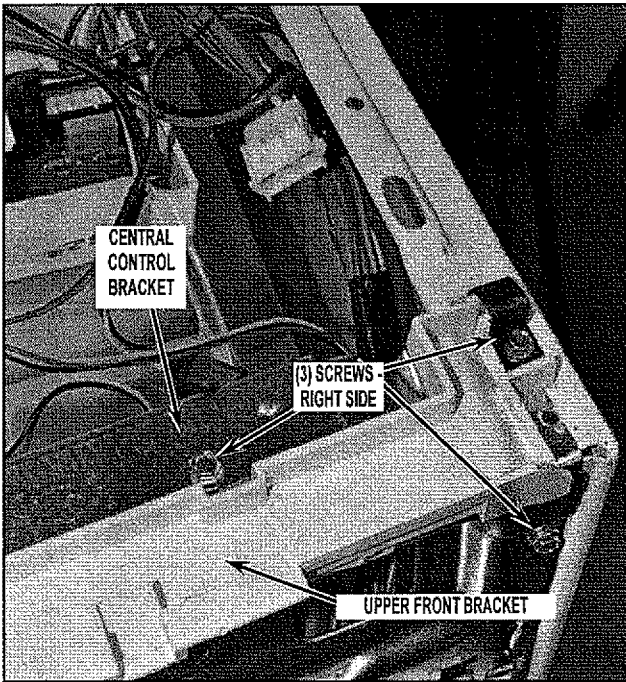

FIGURE 12B

15. Remove bulkhead assembly by first removing four (4) screws securing the bulkhead assembly to cabinet. Slightly lift up on bulkhead assembly and at the same time pulling away from drum working rollers off drum. See Figure 13.

NOTE: During removal of bulkhead, take special notice of the lower protective shield to assure proper placement during reassembly.

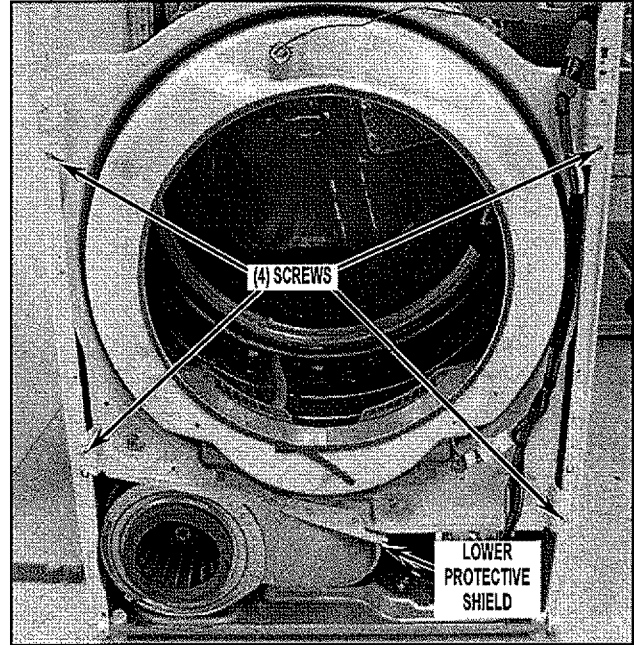

FIGURE 13

16. Swing bulkhead assembly to side and remove two (2) harness clips by pinching ends with pliers to disconnect harness from bulkhead. See Figure 14.

NOTE: This kit is used on some models that do not have the harness routed in the front and do not have the harness clips.

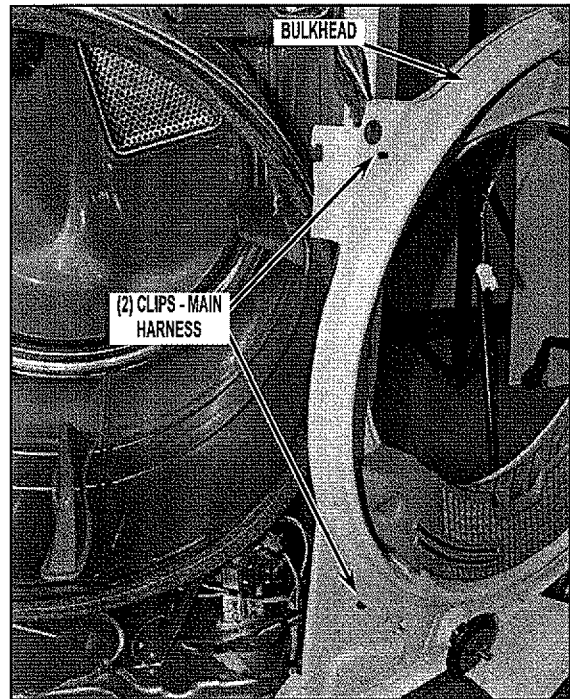

FIGURE 14

17. Before removing drum from dryer the CCU & bracket assembly must be secured in position to side panel using the plastic hook attached to the main harness. This will allow the CCU assembly to hang in place rather than dropping down when the drum is removed. See *Figure 15*.

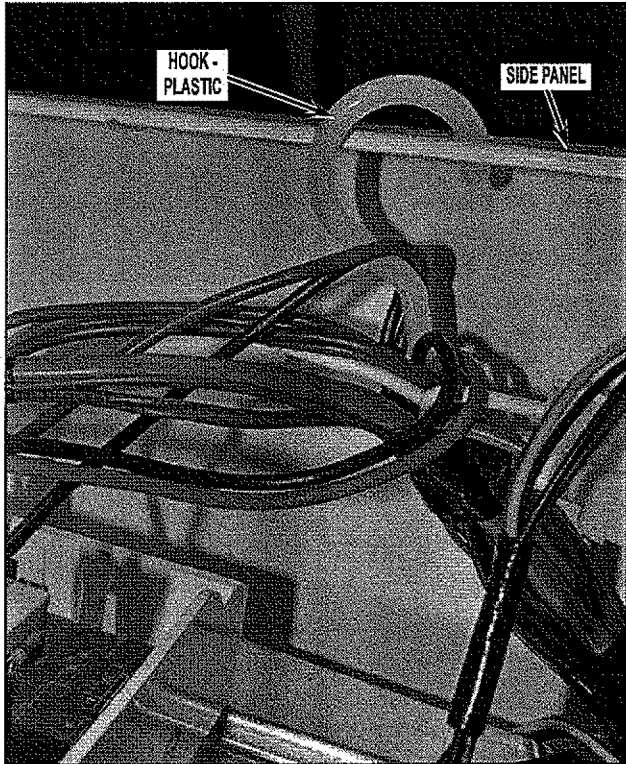

FIGURE 15

18. Remove drum from dryer by reaching into dryer just under the drum to back side of drive motor. Grasp idler pulley and lift up to relieve tension from belt and remove belt from motor pulley and idler pulley. Refer to *Figure 16* for belt removal and reassembly.

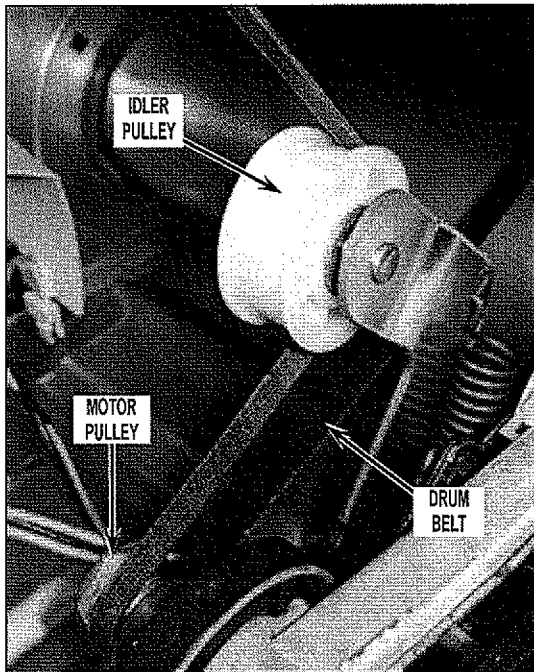

FIGURE 16

19. Remove drum from the dryer by grasping the drum belt and front of drum while sliding drum out of cabinet front.

IMPORTANT: Note position of drum belt, front and rear orientation for reassembly. The drum front opening is larger than the rear drum opening. See *Figure 17*.

NOTE: When removing drum from cabinet be sure not to hit the CCU & bracket assembly knocking it from its hanging position.

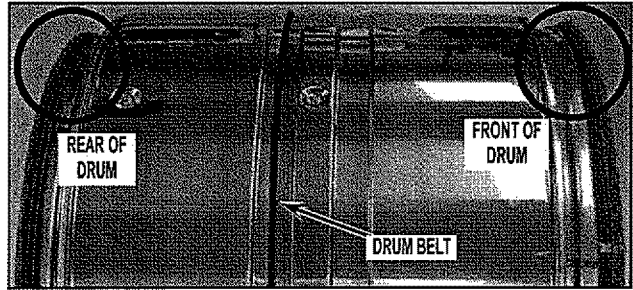

FIGURE 17

20. Remove the existing exhaust vent by removing one (1) 3/8" long screw that secures the vent to the blower housing outlet. See *Figure 18*.

NOTE: The screw (3/8" long) removed in step 20 must be used in this location for reassembly.

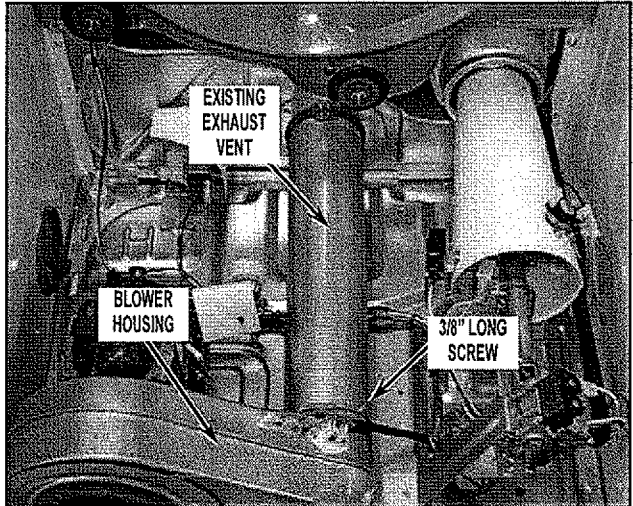

FIGURE 18 (GAS DRYER SHOWN)

21. Remove the vent ring by depressing the three (3) tabs on the ring allowing you to push it out away from dryer rear panel. See *Figure 19*.

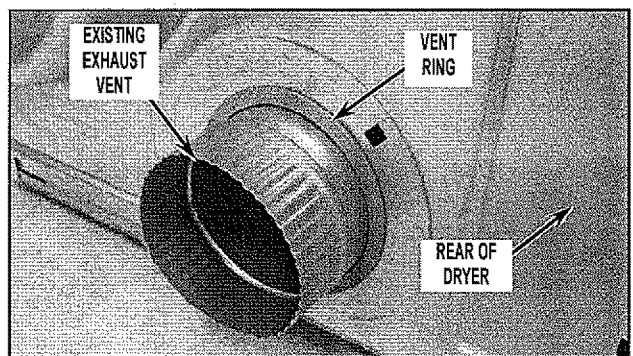

FIGURE 19

(continued)

W10609999 A

⚠ WARNING



Fire Hazard

Install cabinet plug(s) before operating.

Failure to follow these instructions can result in death, fire, electrical shock, or serious injury.

22. Plug the 4" hole in the rear panel that the existing exhaust vent ran through using the metal cover plate included with kit. Use screw included with kit to secure plate in position. Install plate from the inside of the dryer rear panel with tab of plate positioned as shown in *Figure 20*.

NOTE: As recommended, install cover plate from the inside of the dryer with tab located at the bottom of the rear exhaust hole. To aid in installation, take a screwdriver, inserting it into the larger hole in the cover plate and pulling the plate toward the rear.

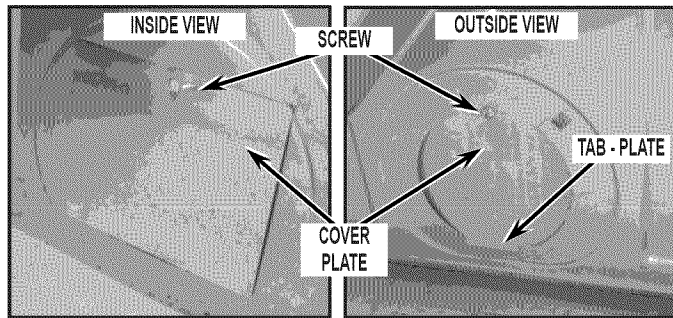

FIGURE 20

23. Use screw included with kit to secure plate in position by driving the retaining screw into the plate's smaller hole to lock the plate in position as shown in *Figure 21*.

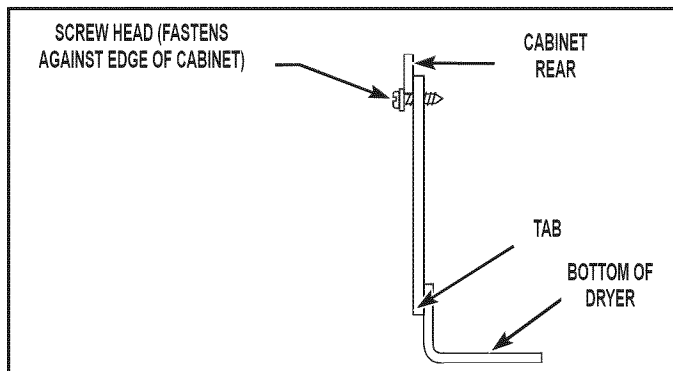

FIGURE 21

NOTE: If dryer was previously setup for side venting leaving an exposed knockout hole or had additional panel knockout removed, from outside of dryer install the plastic plug(s) included with kit to the side panel knockout hole(s). See *Figure 22*.

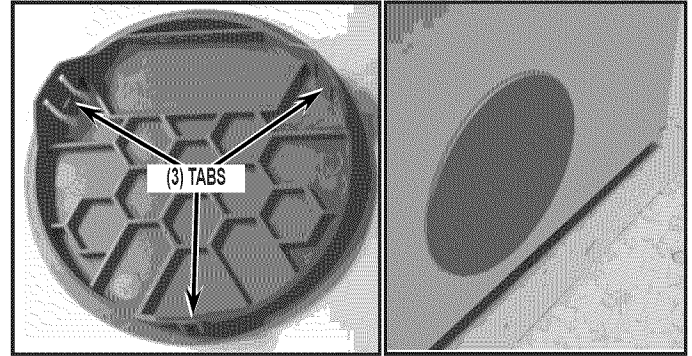

FIGURE 22

NOTE: If dryer was previously setup for bottom venting, from inside of dryer install the metal cover plate with screw included with kit to the bottom panel hole that the vent tube previously existed. See *Figure 23*.

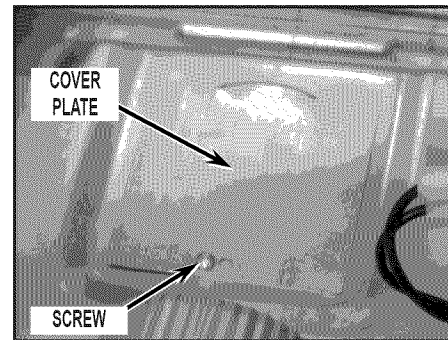

FIGURE 23

24. Verify if electrical tape is located on main wiring harness as shown in *Figure 24*. If not, wrap electrical tape as shown around harness wire lead to prevent possible wire pinching.

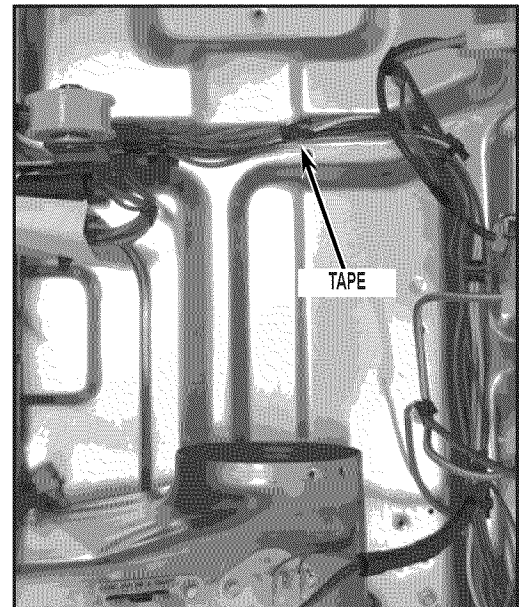

FIGURE 24

VENTING PROCEDURE IS CATEGORIZED IN THREE SECTIONS

NOTE: Determine your new vent direction and follow the section that applies to your application.

Section 1 – Bottom Exhaust Venting

Section 2 – Left Side Exhaust Venting

Section 3 – Right Side Exhaust Venting

Section 1 - Bottom Exhaust Venting

1. Position the dryer into its operating position in the room and measure its rear corner location from the back wall and side wall. Record these dimensions for future use.
2. Using two (2) corner posts from the shipping carton or other protective material on the floor beside the dryer, gently lay dryer on left side.
3. Using either a 1/8" drill bit and drill or a cold chisel and hammer, remove the six (6) knockout retaining tabs around the edge. See *Figure 25*.

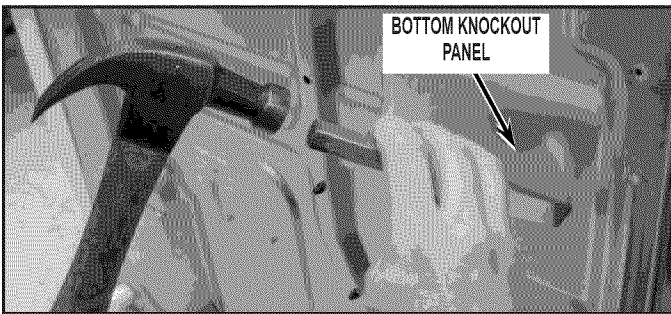

FIGURE 25

4. Using a cold chisel and hammer around the knockout hole edge, work around the edge until the knockout is removed. Use a file to remove the small edge burrs generated by the knockout procedure.
5. Reposition the dryer into its operating position using the dimensions recorded in step 2 above. Using the exhaust hole in the bottom panel as a template, mark the floor accordingly.
6. Attach the 187 mm (7.40") long vent to the blower housing using the 3/8" long screw removed in step 20 of "Procedure for Dryer Disassembly" section. See *Figure 26*.

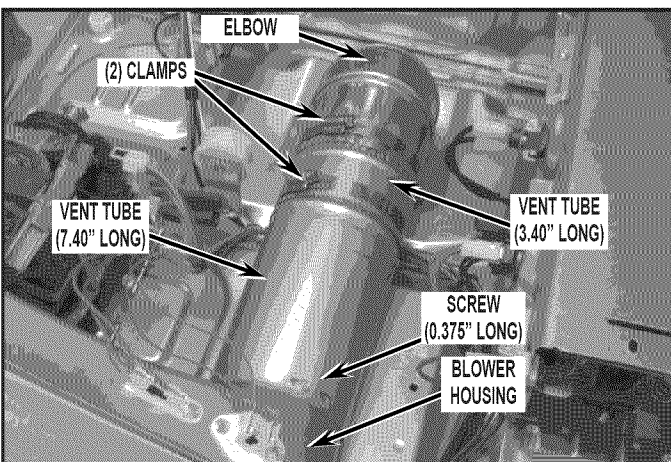

FIGURE 26

7. Create sub-assembly by combining the 86 mm (3.40") long vent tube , the elbow and two clamps included in kit. Slightly tighten clamps to hold assembly together but yet allow for movement at this time.

8. Attach vent tube sub-assembly to the 187 mm (7.40") long vent tube within dryer as shown in *Figure 26*.
9. Assure the positioning of the bottom exhaust vent assembly then securely tighten the clamps. See *Figure 26*.
10. Bottom venting of your dryer is now complete. Reassemble dryer in reverse order as the dryer was disassembled referencing this instruction sheet assuring proper assembly and wire lead connections.
11. Proceed to "Completing Dryer Installation" section at the end of this instruction sheet.

Section 2 - Left Side Exhaust Venting

IMPORTANT: Dryers with the long vent feature, can NOT be vented out to the left side by the use of this kit. Dryers that can NOT be vented out to the left side can be identified by the configuration in *Figure 27*. Note the (2) shafts on the motor and the belt used between the shafts.

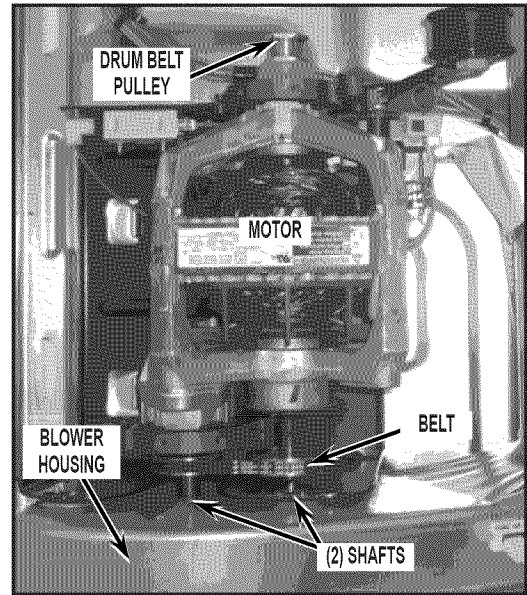

FIGURE 27

NOTE: Allow for a minimum clearance of 10" from wall to dryer side panel if venting exhaust downward after exiting side panel of dryer.

1. As you are facing the dryer, review the lower section of the left side panel. If two (2) knockout features are present remove the MOST REARWARD KNOCKOUT ONLY. See *Figure 28*.

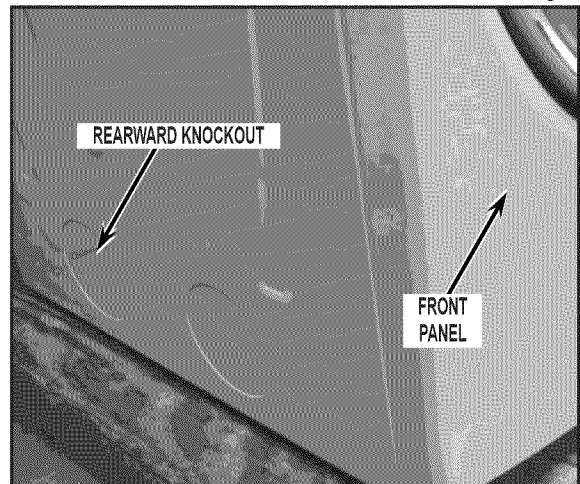

FIGURE 28

(continued)

- To remove the most rearward left side knockout, use either a 1/8" drill bit or a cold chisel and hammer. Remove the six(6) knockout retaining tabs around the edge. See *Figure 29*.

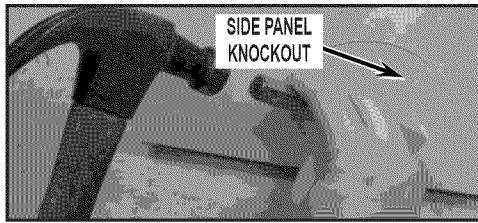

FIGURE 29

- Using a cold chisel and hammer around the knockout hole edge, work around the edge until the knockout is removed. Use a file to remove the small edge burrs generated by the knockout procedure.
- Attach the 187 mm (7.40") long vent to the blower housing using the 3/8" long screw removed in step 20 of "Procedure for Dryer Disassembly" section.
- Attach the 305 mm (12.0") long vent tube and elbow from kit together using clamp included in kit. Tighten clamp to hold sub assembly together. See *Figure 30*.

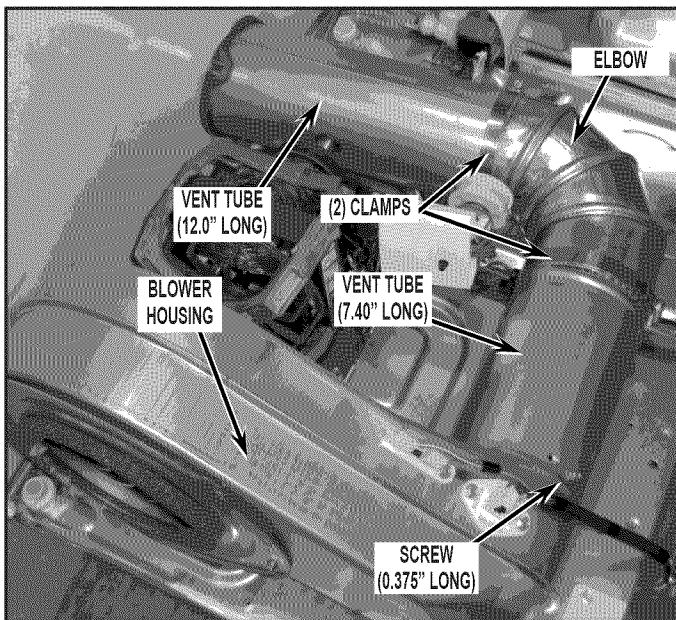

FIGURE 30

- Insert the sub-assembly from Step #5 into the left side knockout hole, rib-end facing out. Slide a clamp onto the elbow and attached elbow end to the 187 mm (7.40") vent tube already in the dryer. See *Figure 30*.
- From the outside of the dryer, install the vent ring included with kit by sliding over exhaust vent tube and snap into place. See *Figure 31*.

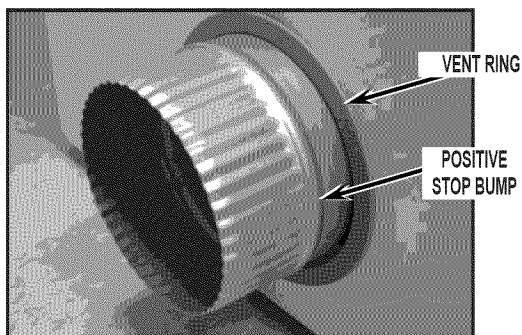

FIGURE 31

- Assure the positioning of the exhaust vent assembly, making sure the positive stop bump on the 305 mm (12.0") long vent tube is on the outside of the dryer. See *Figure 31*. Securely tighten both clamps. See *Figure 30*.
- Left side venting of your dryer is now complete. Reassemble dryer in reverse order as the dryer was disassembled referencing this instruction sheet assuring proper assembly and wire lead connections.
- Proceed to "Completing Dryer Installation" section at the end of this instruction sheet.

Section 3 - Right Side Exhaust Venting

NOTE: Allow for a min. clearance of 10" from wall to dryer side panel if venting exhaust downward after existing side panel of dryer.

- As you are facing the dryer, review the lower section of the right side panel. If two (2) knockout features are present remove the MOST REARWARD KNOCKOUT ONLY. See *Figure 32*.

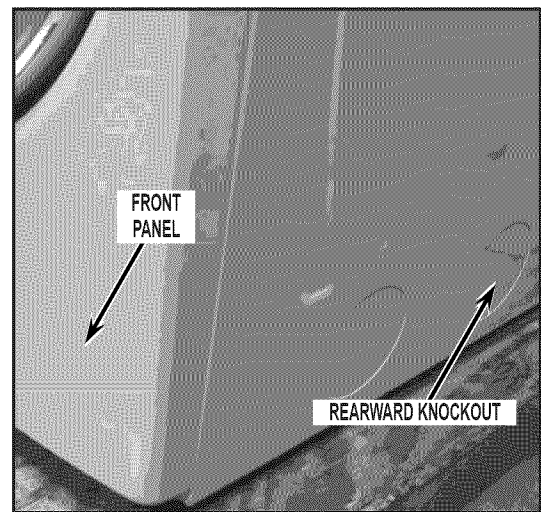

FIGURE 32

- To remove the rearward right side knockout by using either a 1/8" drill bit and drill or a cold chisel and hammer. Remove the six (6) knockout retaining tabs around the edge. See *Figure 33*.

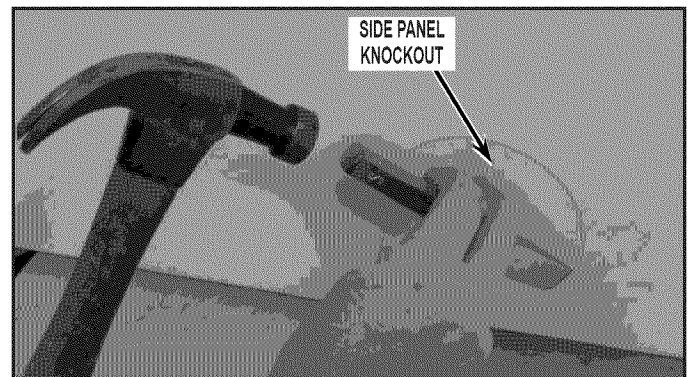

FIGURE 33

- Using a cold chisel and hammer around the knockout hole edge, work around the edge until the knockout is removed. Use a file to remove the small edge burrs generated by the knockout procedure.
- Attach the 187 mm (7.40") long vent to the blower housing using the 3/8" long screw removed in step 20 of "Procedure for Dryer Disassembly" section.

(continued)

- Assemble the 305 mm (12.0") long vent tube and elbow from kit together using clamp included in kit. Tighten clamp to hold sub assembly together. See Figure 34.

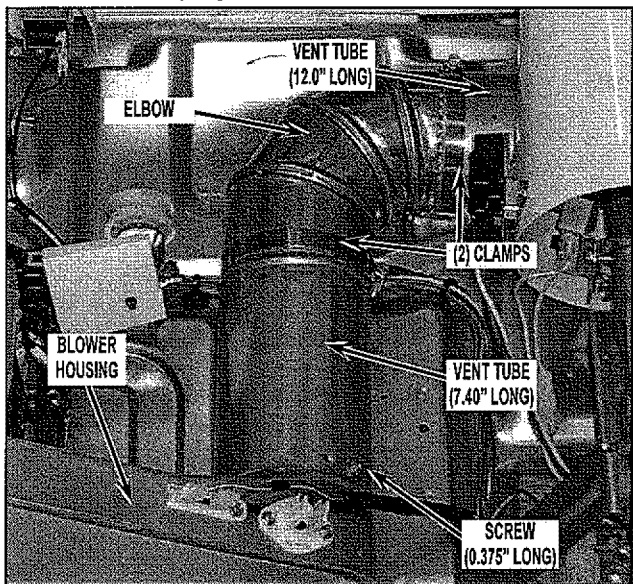

FIGURE 34

- Feed this vent tube sub-assembly into the dryer and out the right side panel exhaust hole. Use clamp included with kit, slide it onto the elbow and press the elbow onto the 187 mm (7.40") vent tube. See Figure 34.
- Assure the positioning of the exhaust vent assembly and securely tighten both clamps. See Figure 34.
- From the outside of the dryer, install the vent ring included with kit by sliding over exhaust vent tube and snap into place. See Figure 35.

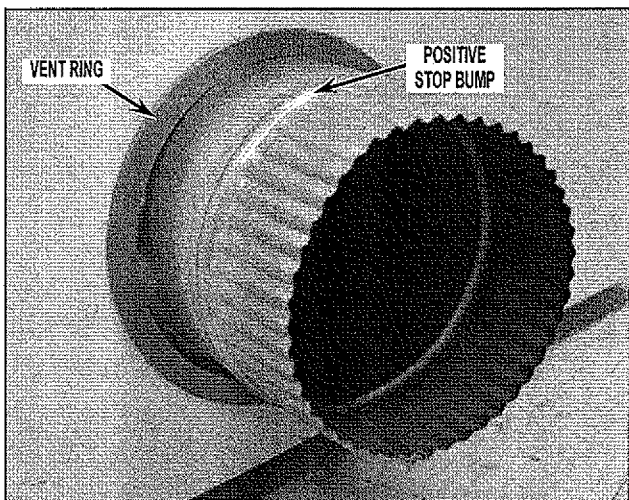

FIGURE 35

- Assure the positioning of the exhaust vent assembly, making sure the positive stop bump on the 305 mm (12.0") long vent tube is on the outside of the dryer. See Figure 35. Securely tighten both clamps. See Figure 34.
- Right side venting of your dryer is now complete. Reassemble dryer in reverse order as the dryer was disassembled referencing this instruction sheet assuring proper assembly and wire lead connections.
- Proceed to "Completing Dryer Installation" section.

Completing Dryer Installation

IMPORTANT: Take special note of specific areas listed below assuring proper re-assembly of dryer.

- Reassemble dryer in reverse order as the dryer was disassembled referencing previous instruction photographs and following the steps below.
- When reinstalling the drum, see Figure 17 for correct drum front direction.
- When reattaching drum belt, verify belt grooves are toward the drum outer surface. Lift up on the idler pulley arm and loop the belt into position as shown in Figure 16. Slowly release the idler arm putting tension on the belt. Slightly lift up on drum front and slowly rotate to verify belt is seated correctly.
- Swing the front bulkhead to the dryer front and reattach the two (2) wire harness clips to the front of the front bulkhead. When re-hanging the front bulkhead to the dryer, make sure the wire harness is not getting pinched and the mid-section of the front bulkhead edge is behind the side panel edge. See Figure 36 as well as Figure 13.

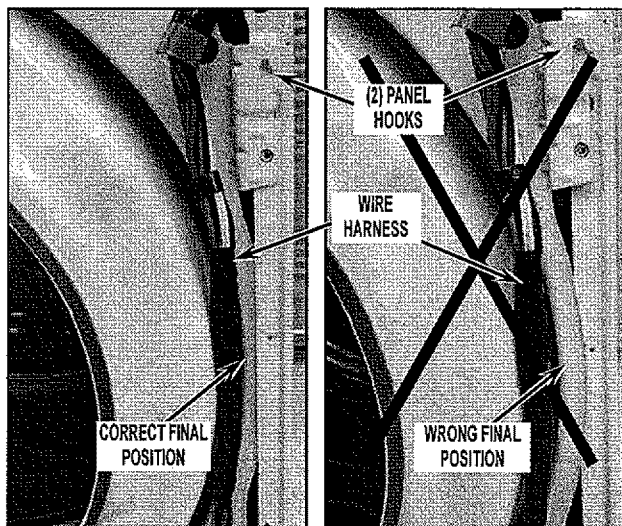

FIGURE 36

- Seat the front bulkhead rollers up under the drum lip and turn the drum to verify they are seated. Reattach four (4) screws in the corners, Figure 13.
- At the bottom of the front bulkhead is a lower protective flap. Verify flap is laying above the blower sensor connectors as shown in Figure 37.

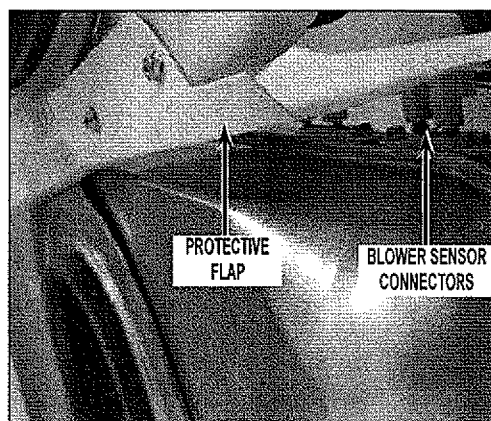

FIGURE 37

(continued)

W10609999 A

- When reattaching the upper front bracket, make sure the central control bracket front is above the upper front bracket, see *Figure 12B*. Insert and push down two (2) ear tabs on either side of bracket, *Figure 38*. Reattach five (5) screws as shown in *Figures 12A and 12B*.

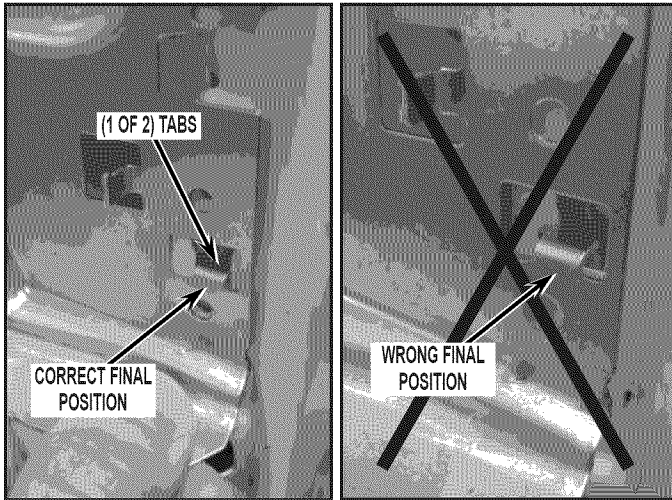

FIGURE 38

- When reattaching the blower housing lint duct and its screws, see *Figure 11*, verify the lower plastic lint duct clip is hooking the lint duct correctly. See *Figure 39*.

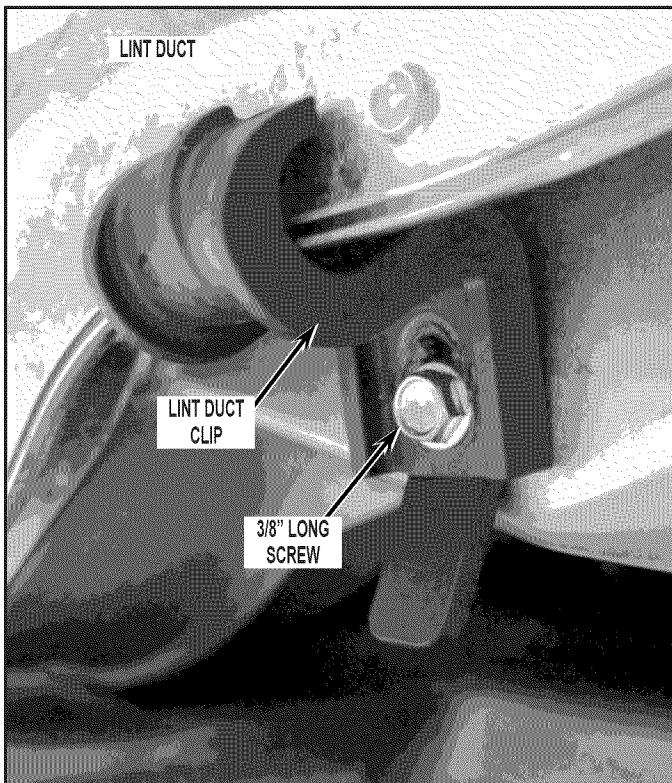

FIGURE 39

- Reconnect the moisture sensor connector. See *Figure 10*.
- Reinsert the lint screen. See *Figure 9*.

- When re-hanging the front panel and door assembly onto the two (2) tabs, *Figure 8*, verify the door switch connector is also properly fed up and behind the upper front bracket. Attach the three (3) upper screws, *Figure 7*. Connect the door switch, *Figure 4*. Holding the front panel in position to prevent bending it, open the dryer door and reattach two (2) Phillip-head screws, *Figure 5*. Attach the four (4) lower screws, *Figure 6*.
- Take the front console and feed the two connectors through the right hole in the upper front bracket. Set the two console bottom corner posts into the front panel top slots and tip the console toward back clicking its top lip over the top edge of the upper front bracket. Reconnect the drum light and main console connectors, *Figure 4*. Reattach the two (2) upper screws, *Figure 3*.
- Take the front edge of the top panel and set it into the plastic tray of the upper front bracket, *Figure 2*. Set the remaining top panel down and slide it forward into position. Reattach the two (2) rear screws, *Figure 1*.
- Reposition dryer to operating position.
- Connect external exhaust vent to dryer.

⚠ WARNING



Electrical Shock Hazard

Plug into a grounded 3 prong outlet.

Do not remove ground prong.

Do not use an adapter.

Do not use an extension cord.

Failure to follow these instructions can result in death, fire, or electrical shock.

- Plug in dryer or reconnect power.

NOTE: For gas dryer application, connect flexible gas supply line to rear of dryer. Turn on gas supply and check for leaks by brushing or spraying approved non-corrosive leak detection solution onto connection at rear of dryer. If any bubbles are present turn off gas supply, tighten the leaking connection and retest for leaks.

- Check to assure all components are attached securely in place and lint screen has been installed to dryer.
- Check that dryer is working properly.