



HOW TO MAKE A HOME RUN™

Use And Care

G U I D E



CONTINUOUS AND STANDARD-CLEANING GAS RANGES

TO THE INSTALLER: PLEASE LEAVE THIS INSTRUCTION BOOK WITH THE UNIT.

TO THE CONSUMER: PLEASE READ AND KEEP THIS BOOK FOR FUTURE REFERENCE.

MODELS SF330PEA
SF310PEA

7194

A Note To You

Thank you for buying a Whirlpool® appliance.

Because your life is getting busier and more complicated, Whirlpool ranges are easy to use, save time, and help you manage your home better. To ensure that you will enjoy years of trouble-free operation, we developed this Use and Care Guide. It is full of valuable information on how to operate and maintain your appliance properly and safely. Please read it carefully. Also, please complete and mail the Ownership Registration Card provided with your appliance. This will help us notify you about any new information on your appliance.

Your safety is important to us.

This guide contains safety symbols and statements. Please pay special attention to these symbols and follow any instructions given. Here is a brief explanation of the use of each symbol.

⚠ WARNING

This symbol will help alert you to such dangers as personal injury, burns, fire and electrical shock.

⚠ CAUTION

This symbol will help you avoid actions which could cause product damage (scratches, dents, etc.) and damage to your personal property.



⚠ WARNING

- ALL RANGES CAN TIP.
- INJURY TO PERSONS COULD RESULT.
- INSTALL ANTI-TIP DEVICES PACKED WITH RANGE.
- SEE INSTALLATION INSTRUCTIONS.

For more information, see the "The anti-tip brackets" on page 15.

Our Consumer Assistance Center number, 1-800-253-1301, is toll-free, 24 hours a day.

If you ever have a question concerning your appliance's operation, or if you need service, first see "If You Need Assistance Or Service" on page 25. If you need further help, feel free to call our Consumer Assistance Center. When calling, you will need to know your appliance's complete model number and serial number. You can find this information on the model and serial number plate (see diagram on page 6). For your convenience, we have included a handy place below for you to record these numbers, the purchase date from the sales slip and your dealer's name and telephone number. Keep this book and the sales slip together in a safe place for future reference.

Model Number _____

Dealer Name _____

Serial Number _____

Dealer Phone _____

Purchase Date _____

Important Safety Instructions

READ AND SAVE THESE INSTRUCTIONS

Gas ranges have been thoroughly tested for safe and efficient operation. However, as with any appliance, there are specific installation and safety precautions which must be followed to ensure safe and satisfactory operation.

⚠ WARNING

To reduce the risk of fire, electrical shock, injury to persons, or damage when using the range, follow basic precautions, including the following:

WARNING: If the information in this manual is not followed exactly, a fire or explosion could result causing property damage, personal injury or death.

Do not store or use gasoline or other flammable vapors and liquids in the vicinity of this or any other appliance.

WHAT TO DO IF YOU SMELL GAS:

- Do not try to light any appliance.
- Do not touch any electrical switch; do not use any phone in your building.
- Immediately call your gas supplier from a neighbor's phone. Follow the gas supplier's instructions.
- If you cannot reach your gas supplier, call the fire department.

Installation and service must be performed by a qualified installer, service agency or the gas supplier.

General

- Install or locate the range only in accordance with the provided Installation Instructions. The range must be installed by a qualified installer. The range must be properly connected to the proper gas supply and checked for leaks. The range must also be properly connected to electrical supply and grounded.
- Gas fuels and their use in appliances can cause minor exposures to benzene, formaldehyde, carbon monoxide and soot, primarily from incomplete combustion. Significant exposure to these substances could cause cancer or reproductive harm. Properly adjusted burners with a blue, rather than a yellow, flame will minimize incomplete combustion. Venting with a hood or an open window will further minimize exposure.
- Do not store things children might want above the range. Children could be burned or injured while climbing on it.
- Do not leave children alone or unattended in area where the range is in use. They should never be allowed to sit or stand on any part of the range. They could be burned or injured.
- Do not operate the range if it is damaged or not working properly.

continued on next page

IMPORTANT SAFETY INSTRUCTIONS

- Do not use the range for warming or heating the room. Persons could be burned or injured, or a fire could start.
- Do not attempt to light the oven burner during a power failure. Personal injury could result. Reset oven controls to the off position in the event of a power failure.
- Use the range only for its intended use as described in this manual.



- Do not touch surface burners, areas near surface burners or interior surfaces of oven. Areas near surface burners and interior surfaces of an oven become hot enough to cause burns. During and after use, do not touch, or let clothing or other flammable materials contact surface burners, areas near surface burners or interior surfaces of oven until they have had sufficient time to cool. Other surfaces of the range, such as the oven vent opening, the surface near the vent opening, the cooktop, and the oven door and window, could also become hot enough to cause burns.



- Do not wear loose or hanging garments when using the range. They could ignite if they touch an open flame and you could be burned.

- Use only dry potholders. Moist or damp potholders on hot surfaces could result in burns from steam. Do not let potholder touch an open flame. Do not use a towel or bulky cloth for a potholder. It could catch on fire.
- Keep range vents unobstructed.
- Do not heat unopened containers. They could explode. The hot contents could cause burns and container particles could cause injury.
- Do not store flammable materials on or near the range. The fumes could create an explosion and/or fire hazard.
- Do not use the oven for storage.
- Do not use aluminum foil to line reflector pans, oven bottom, or any other part of the range. Use aluminum foil only as recommended in this manual.
- Never use a match or other flame to look for a gas leak. Explosion and injury could result.
- Know where your main gas shutoff valve is located.

When using the cooktop

- Make sure the utensils you use are large enough to contain food and avoid boilovers and spillovers. Heavy splattering or spillovers left on a range could ignite and burn you. Pan size is especially important in deep fat frying.
- Check to be sure glass cooking utensils are safe for use on the range. Only certain types of glass, glass-ceramic, ceramic, earthenware or other glazed utensils are suitable for cooktops without breaking due to the sudden change in temperature.
- Never leave surface burners unattended at high heat settings. A boilover could result and cause smoking and greasy spillovers that could ignite.

IMPORTANT SAFETY INSTRUCTIONS



- Turn pan handles inward, but not over other surface burners. This will help reduce the chance of burns, igniting of flammable materials, and spills due to bumping of the pan.
- Do not use decorative covers or trivets over the surface burners.

When using the oven

- Always position the oven rack(s) in desired location while oven is cool.
- Use care when opening oven door. Let hot air or steam escape before removing or replacing food.

Grease

- Grease is flammable. Do not allow grease to collect around cooktop or in vents. Wipe spillovers immediately.



- Do not use water on grease fires. Never pick up a flaming pan. Smother flaming pan by covering with a well-fitted lid, cookie sheet or flat tray. Flaming grease outside of pan can be extinguished with baking soda or, if available, a multipurpose dry chemical or foam-type extinguisher.

Care and cleaning

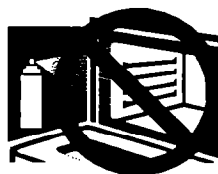

- Do not use oven cleaners in continuous-cleaning oven model. No commercial oven cleaner or oven liner protective coating of any kind should be used in or around any part of the oven.
- Do not clean door heat seal. It is essential for a good seal. Care should be taken not to rub, damage or move the seal. Clean only parts recommended in this Use and Care Guide.
- Do not repair or replace any part of the range unless specifically recommended in this manual. All other servicing should be referred to a qualified technician.
- Any additions, changes or conversions required in order for this appliance to satisfactorily meet the application needs must be made by a Whirlpool® service company or Qualified Agency.
- Disconnect the electrical supply and the gas supply at the shutoff valve near the range before servicing the range.

– READ AND SAVE THESE INSTRUCTIONS –

Parts And Features

This section contains captioned illustrations of your range. Use them to become familiar with the location and appearance of all parts and features.

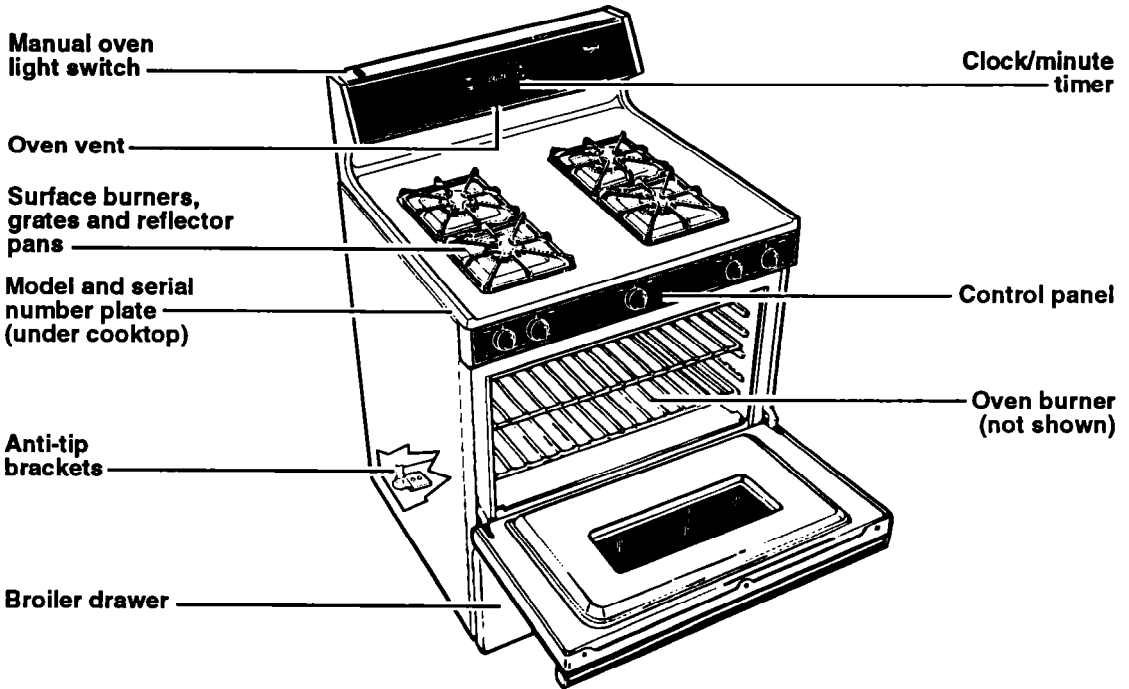

Control panel

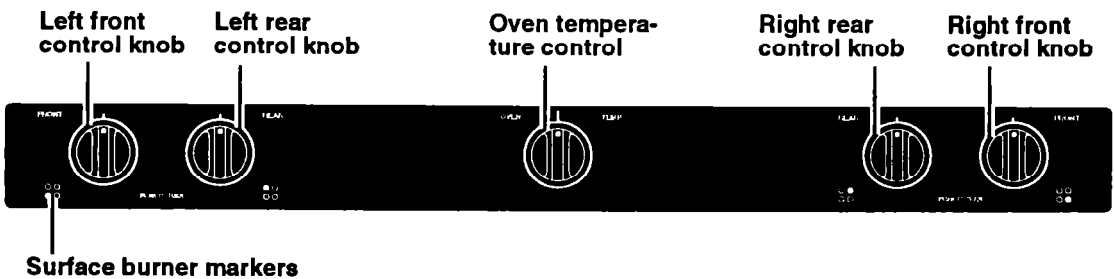

Using Your Range

In This Section		Page	Page
Using the surface burners	7	Adjusting the oven temperature control	13
Positioning racks and pans	9	Broiling	13
For best air circulation	10	Energy saving tips	14
Setting the clock	10	The oven vent	15
Using the Minute Timer	11	The anti-tip brackets	15
Baking/roasting	12		

To obtain the best cooking results possible, you must operate your range properly. This section gives you important information for efficient and safe use of your range.

Using the surface burners

Your range is equipped with electric ignitors. Electric ignitors automatically light the burners each time they are used.

Push in control knob and turn counterclockwise to the LITE position. The clicking sound is the ignitor sparking. Visually check that burner has lit.

To stop the clicking sound after the burner lights, turn the control knob to the desired setting. You can set the control knob anywhere between HI and LO.

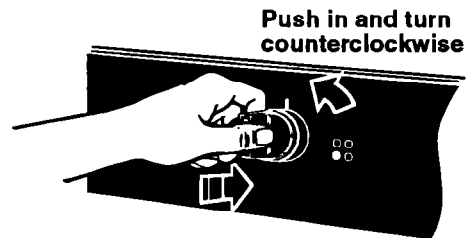

Surface burner markers

The solid dot in the surface burner marker shows which surface burner is turned on by that knob.

Burner heat settings

Use correct burner heat settings (see next page). If the heat setting is too high, it can:

- **Char** bacon and cause curling.
- **Make** eggs tough and crisp at the edges.
- **Toughen** liver, fish and seafood.
- **Scorch** delicate sauces and custards.
- **Cause** a boilover.

USING YOUR RANGE

Until you get used to the settings, use the following as a guide. For best results, start cooking at the high setting; then turn the control knob down to continue cooking.

SETTING	RECOMMENDED USE
LITE	<ul style="list-style-type: none">• To light the burner. After the burner lights, turn control back to a desired setting.
HI	<ul style="list-style-type: none">• To start foods cooking.• To bring liquids to a boil.
Medium	<ul style="list-style-type: none">• To hold a rapid boil.• To fry chicken or pancakes.• For gravy, pudding and icing.• To cook large amounts of vegetables.
LO	<ul style="list-style-type: none">• To keep food warm until ready to serve.

NOTE: Do not cook with the control in the LITE position.

In case of a prolonged power failure

Surface burners can be manually lighted. Hold a lit match near a burner and turn the control knob to the LITE position. After the burner lights, turn the control knob to the desired setting.

⚠ WARNING

Burn, Fire and Explosion Hazard

- Burner flame should not extend beyond the edge of the cooking utensil. The flame could burn you and cause poor cooking results.
- Be sure all control knobs are turned to OFF when you are not cooking. Someone could be burned or a fire could start if a burner is accidentally left ON.
- If the flame should go out while cooking, or if there is a strong gas odor, turn the burners OFF. Wait five minutes for the gas odor to disappear before relighting burner. If gas odor is still present, see safety note on page 3. Failure to follow these precautions could result in explosion or fire.

Product Damage Hazard

Do not leave an empty utensil, or one which has boiled dry, on a hot surface burner.

The utensil could overheat and could damage the utensil or cooking product.

Cookware tips

No one brand of cookware is best for all people. Knowing something about pan materials and construction will help you select the correct cookware for your needs.

- **NOTE: For best results and greater fuel efficiency,** use only flat-bottomed cookware in good condition.
- **The pan** should have straight sides and a tight-fitting lid.
- **Choose medium to heavy gauge** (thickness) pans that are fairly lightweight.
- **The pan material** (metal or glass) affects how fast heat transfers from the surface burners through the pan material and how evenly heat spreads over the pan bottom. Choose pans that provide the best cooking results.

- **Handles** should be made of a sturdy, heat-resistant material and be securely attached to the pan.
- **Pans** should be easy to clean. Check to be sure there are no crevices, rough edges or areas where food might collect.
- **Be sure pans** do not tip, whether they are full or empty.
- **Use cookware** only as it was intended to be used. Follow pan instructions. This is very important for glass cookware because some should be used only in the oven. Other pans are marked as flameware and may be used on the surface burners.

Home canning information

The large diameter of most water-bath or pressure canners combined with high heat settings for long periods of time can cause damage to the cooktop.

To protect your range:

- **For best results**, use a canner which can be centered over the surface burner.
- **Do not place canner** on two surface burners at the same time. Too much heat will build up and will damage the cooktop.
- **Start with hot water.** This reduces the time the control is set on high. Reduce heat setting to lowest position needed to keep water boiling.
- **Keep reflector pans** clean for best heat reflection.
- **Refer** to your canner manual for specific instructions.

Positioning racks and pans

For baking/roasting with one rack, place the rack so the top of the food will be centered in the oven.

Rack placement for specific foods:

FOOD	RACK POSITION
Frozen pies, large roasts, turkeys	1st or 2nd rack guide from bottom
Angel and bundt cakes, most quick breads, yeast breads, casseroles, meats	2nd rack guide from bottom
Cookies, biscuits, muffins, cakes, nonfrozen pies	2nd or 3rd rack guide from bottom

When baking on two racks, arrange racks on first and third rack guides from bottom.

⚠ WARNING

Personal Injury Hazard

- Always position oven rack(s) in desired location before turning oven on. Be sure the rack(s) is level.
- If rack(s) must be moved while oven is hot, use potholders or oven mitts to protect hands.
- Do not place items on the open oven door.
- Be careful when installing and removing large food items from extra roasting rack position. Food will be close to hot surfaces, including oven bottom and sides.

Failure to follow the above precautions could result in personal injury.

USING YOUR RANGE

Extra oven rack position (roasting rack)

When roasting food too large to be placed in oven with rack in lowest position, place rack on bottom of oven.

For proper roasting, follow these guidelines:

- **The rack must be level.**
- **Use** adequate amount of liquid (meat juices or water) so food does not get overdone.
- **Do not try to pull rack out over door.** Rack will be at the same level as door when door is opened.



Extra oven rack position

For best air circulation

Hot air must circulate around the pans in the oven for even heat to reach all parts of the oven. This results in better baking.

- **Place the pans** so that one is not directly over the other.
- **For best results, allow** 1½-2 inches (4-5 cm) of space around each pan and between pans and oven walls. There must be a minimum space of 1 inch (2.5 cm).
- **Use** only one cookie sheet in the oven at one time.

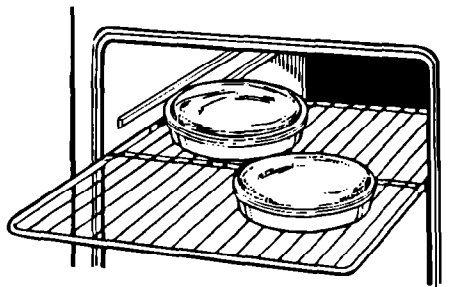

Use the following as a guide to determine where to place the pans:

One pan

Place in the center of the oven rack.

Two pans

Place in opposite corners of the oven rack.

Three or four pans

Place in opposite corners on each oven rack. Stagger pans so no pan is directly over another.

Setting the clock

When you first plug in the range, or if your electricity was off for a while, the display will show "88:88", then change to "--:--". SET and CLOCK will show on the display.

1. **Push** the Clock Set button. "12:00" will show on the display.



2. Push the “up” or “down” pad to set the time of day. Each “tap” of the “up” or “down” pad will increase or decrease the displayed time by one minute. If the “up” or “down” pad is held down, the displayed time will increase/decrease in ten-minute increments.
3. Push the Clock Set button to start clock operation.



Using the Minute Timer

The Minute Timer does not start or stop the oven. It works like a kitchen timer. Set it in minutes up to 24 hours.

1. Push the Timer On/Off button. SET and TIMER will come on and the display will show “:00”.
2. Push the “up” or “down” pad to set the desired time. Each “tap” of the “up” or “down” pad will increase or decrease the displayed time by one minute. If the “up” or “down” pad is held down, the displayed time will increase/decrease in ten-minute increments.
3. To cancel the Minute Timer after the countdown is over, push the Clock Set button and the display will return to the time of day. You will hear two tones every 10 seconds until you cancel the Minute Timer.



NOTES:

- When the Minute Timer reaches one minute, it will count down in seconds.
- To see the clock time when the Minute Timer is running, push the Clock Set button **once**. To switch back to the Minute Timer, push the Timer On/Off button **once**.
- To cancel the Minute Timer during a countdown, push the Timer On/Off button **twice**. The display will show “:00” and SET TIMER. Then the display will return to the time of day.

Baking/roasting

NOTE: Do not attempt to light the oven burner during a power failure. See "Important Safety Instructions" on page 4 for more information.

1. **Position the rack(s) properly before turning on the oven. To change rack position, lift rack at front and pull out.** For further information, see "Positioning racks and pans" on page 9.
2. **Push in and turn the Oven Temperature Control counterclockwise to the baking/roasting temperature you want.** The oven burner will automatically light in 50-60 seconds.
3. **When baking, preheat the oven for 10 minutes. Put food in the oven.**

NOTES:

- **Do not preheat** when roasting or cooking items such as casseroles.
 - **Do not place** food directly on the oven bottom.
4. **During baking/roasting, the oven burner will turn on and off to maintain the temperature setting.**

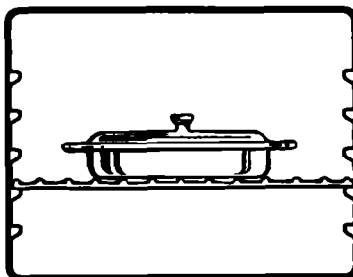
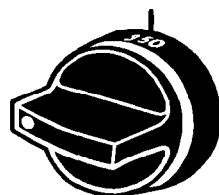

5. **When baking/roasting is done, turn the Oven Temperature Control clockwise to OFF.**

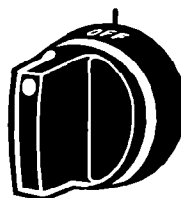

Adjusting the oven temperature control

Oven temperature controls will gradually shift after years of use. So, even though your new oven is properly adjusted to provide accurate temperatures, it may cook faster or slower than your old oven.

If, after using the oven for a period of time, you are not satisfied with the temperature settings, you can adjust them by following these steps:

1. **Make sure** the Oven Temperature Control Knob is turned to the off position. **Pull knob straight off and flip it over.**
2. **Loosen** the locking screws inside the control knob. **Note the position of the notches.**
3. **To lower the temperature, hold knob handle firmly and move the tooth a notch clockwise.** Each notch equals about 20°F (11°C).
4. **To raise the temperature, hold knob handle firmly and move the tooth a notch counterclockwise.** Each notch equals about 20°F (11°C).
5. **Tighten** the locking screws and **replace** the control knob.

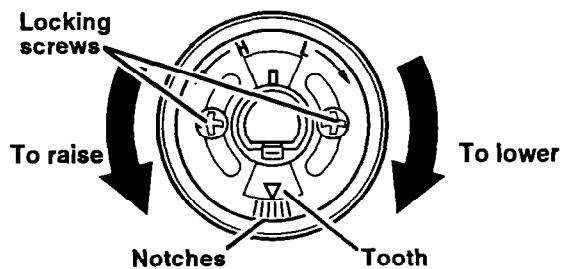
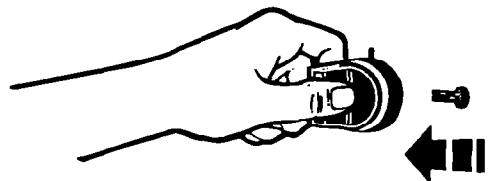

Broiling

The broiler drawer is located below the oven door. **Always broil with the oven door closed.**

1. **Pull** the broiler drawer open and **tilt** the door panel down.
2. **Place** broiler pan grid so grease can drain down ribbing and through slots into lower part of the broiler pan. **See picture.**
3. **Before the broiler is turned on, place** food on broiler pan and **position** the broiler pan at one of the three levels.
4. **Close** broiler drawer.

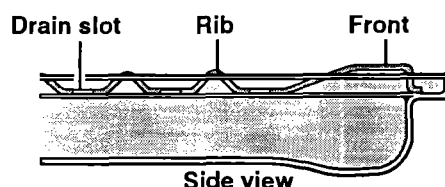
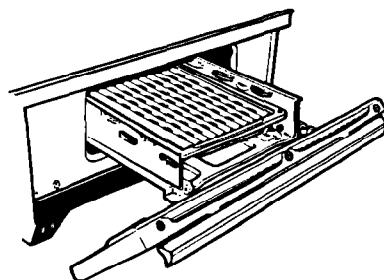

USING YOUR RANGE

5. Push in and turn the Oven Temperature Control **counterclockwise** to BROIL. The broiler will automatically light in 50-60 seconds.

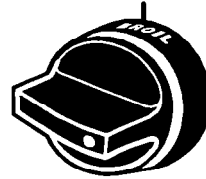

6. When broiling is done, turn the Oven Temperature Control **clockwise** to OFF.

NOTE: Do not preheat the broiler before using. Completely close the broiler drawer during broiling.

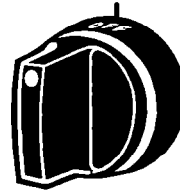

Energy saving tips

Although the energy used for cooking is usually a very small percentage of the total energy used in the home, cooking energy can be used efficiently. Here are some tips to help you save energy when using your cooking product:

- **Use** pans with flat bottoms, straight sides and tight-fitting lids.
 - **Cook** with a minimum of liquid or fat to help shorten cooking time.
 - **Preheat** pans only when recommended and for the shortest time possible.
 - **Start** food on higher heat settings, then set surface burner control on low to finish cooking.
 - **Use** the more efficient surface burners instead of the oven when possible.
 - **Turn on** the surface burner only after placing filled pan on the burner grate.
- **“Oven peeking”** may cause heat loss, longer cooking times and unsatisfactory baking results. Rely on your timer to keep track of the cooking time.
 - **Bake** cakes, pies or cookies when oven is warm. Best time to bake is right after a meal has been cooked in oven.
 - **Preheat** the oven no longer than necessary.
 - **Plan** your meals for the most efficient use of the range. When using the oven to cook one food, try to cook the rest of the meal in it also.
 - **Do not preheat** when broiling, roasting or cooking items such as casseroles.
 - **Keep** reflector pans clean for best heat reflection.

The oven vent

Hot air and moisture escape from the oven through a vent located in lower part of backguard. The vent is needed for air circulation. **Do not block the vent.** Poor baking/roasting will result.

NOTE: Never store plastics, paper or other items that could melt or burn near the oven vent, or any of the surface burners.

Oven vent

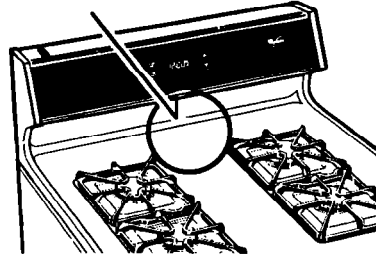

⚠ WARNING

Burn Hazard

When the oven is ON, pans and pan handles left near the oven vent could become hot enough to burn the user and to melt plastics. Use potholders to move pans.

The anti-tip brackets

The range will not tip during normal use. However, tipping can occur if you apply too much force or weight to the open door without the anti-tip brackets properly secured.



⚠ WARNING

Personal Injury Hazard

- To reduce risk of range tipping over, secure range with properly installed anti-tip brackets supplied with range.
 - If range is moved for cleaning or service, check that anti-tip devices are engaged before using range.
- Failure to follow the above precautions could result in personal injury.

To verify the anti-tip brackets are engaged:

- **Grasp** rear of range and carefully try to tilt forward. If anti-tip brackets are attached to floor with screws and rear leveling legs are positioned under brackets (one for each rear leveling leg), range should not tilt forward.
- **See** Installation Instructions for further details.

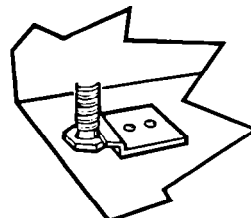

Caring For Your Range

In This Section

	Page	Page	
Surface burner grates and reflector pans	16	Removing the oven bottom	19
Lift-up cooktop	17	The continuous-cleaning oven	20
Surface burners	17	Cleaning chart	22
Removing the oven door	18	The oven light	24

Your range is designed for easy care. You can do most cleaning with items found around your home. Cleaning your range whenever spills or soiling occurs will help to keep it looking and operating like new.

⚠ WARNING

Burn, Electrical Shock, Fire and Explosion Hazard

- Make sure all controls are OFF and the range is cool before cleaning.
- For continuous-cleaning ovens, do not use oven cleaners, bleach or rust removers.
- Do not obstruct the flow of combustion and ventilation air.
- Keep appliance area clear and free of combustible materials, gasoline and other flammable vapors and liquids.

Failure to follow these guidelines could result in burns, electrical shock, fire or explosion.

Surface burner grates and reflector pans

1. **Make sure** all surface burners are off and the surrounding parts are cool.
2. **Lift off** the surface burner grates and **remove** the reflector pans.
3. **Wash** the grates and reflector pans with warm, soapy water or in a dishwasher. **Use** a nonabrasive, plastic scrubbing pad for cooked-on foods. **Rinse** and **dry** well.
4. **Replace** reflector pans and burner grates.

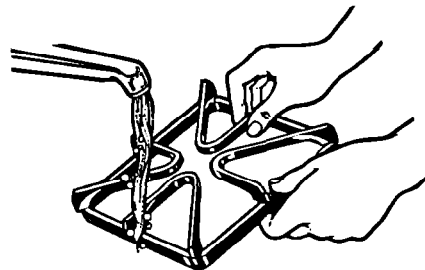

Lift-up cooktop

1. **Remove** surface burner grates and reflector pans.
2. **Lift** front of cooktop at both front corners until the support rods lock into place.

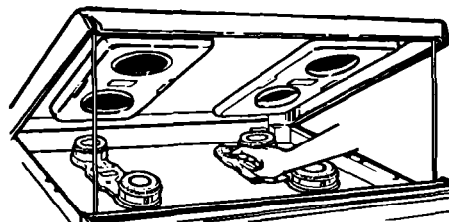

⚠ WARNING

Personal Injury Hazard

Be sure both support rods are fully extended and in the locked position.

Failure to do so could result in personal injury from the cooktop accidentally falling.

Product Damage Hazard

Do not drop the cooktop.

Damage could result to the porcelain and the cooktop frame.

3. **Wipe** with warm, soapy water. **Use** a soapy steel-wool pad on heavily soiled areas.
4. **To lower the cooktop**, lift cooktop from both sides while pressing the support rods back to unlock them. **Lower** the cooktop into place. **Replace** reflector pans and surface burner grates.

Surface burners

1. **Lift up** the cooktop, following the instructions above.
2. **Before cleaning**, remove screws that hold each of the burners in place. The screws prevent the burners from moving during shipment. **Remove** the shipping screws with a Phillips screwdriver and **lift** the burners up and out. This separates the burners from the mounting bracket under each burner pair.
3. **Wipe off** surface burners with warm, soapy water and a sponge after each use. **To remove cooked-on food**, soak the burners in a vinegar and water solution for 20-30 minutes. **Scrub** with a plastic scrubbing pad.
4. **If ports are clogged**, clean with a straight pin. **DO NOT enlarge or distort the ports.** **DO NOT use a toothpick to clean the ports.**

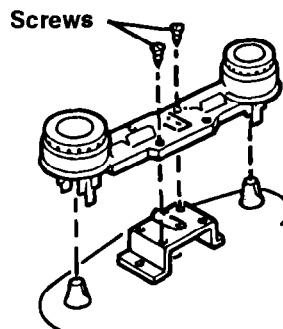

CARING FOR YOUR RANGE

5. **Before putting the burners back, dry** them thoroughly by setting them in a warm oven for 30 minutes.
6. **Replace** burners, making sure they are properly seated and level. **Replace** screws.
7. **Occasionally check** the burner flames for proper size and shape as shown. A good flame is blue in color. If flames lift off ports, are yellow, or are noisy when turned off, you may need to clean the burners (see page 17), or call a qualified technician for adjustment.

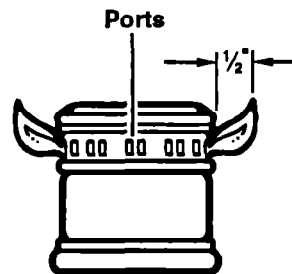

Typical surface burner flame at highest setting

Removing the oven door

Removing the oven door will help make it easier to clean the oven.

⚠ WARNING

Burn and Electrical Shock Hazard

Make sure all controls are OFF and the oven is cool before removing oven door.

Failure to do so could result in burns or electrical shock.

To remove:

1. **Open** the door as far as it will go.
2. **Remove** the screws on each side of the oven door.
3. **Close** the door about $\frac{3}{4}$ of the way.
4. **Lift** the door up and off the hinges.

To replace:

1. **Be sure** the hinge arms are in the open position. **Be careful** if pulling the hinges open by hand. Hinges may snap back against the oven frame and could pinch fingers.

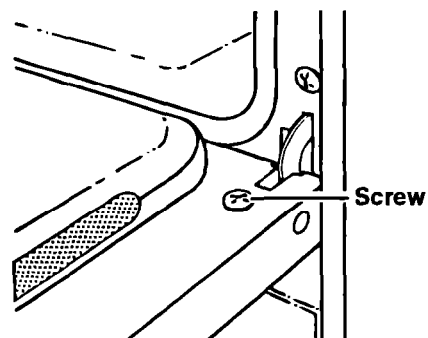

2. **Hold** the door at the sides near the top. **Insert** hinge arms into slots at the bottom of the door. **Insert** arms evenly, as far as they will go.
3. **If the door is not in line with the oven frame, remove it and repeat the above steps.**
4. **Replace** the screws on the oven door.

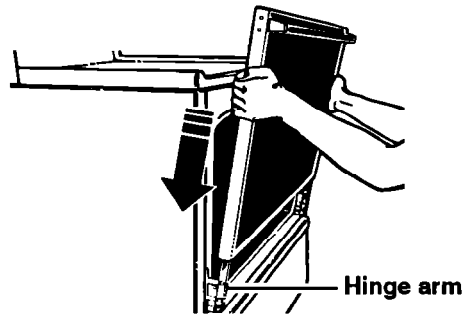

Removing the oven bottom

The panel in the oven bottom can be removed for cleaning.

⚠ WARNING

Burn Hazard

Make sure all parts are cool before removing.

Failure to do so could result in burns.

To remove:

1. **Remove** oven racks.
2. **Remove** the two hold-down screws at the rear of the oven. If screws are too tight to remove by hand, **use** a screwdriver.
3. **Place** fingers in slots in bottom panel and **lift** rear of panel up and back until lip at the front of panel is clear of front frame of oven cavity.
4. **Lift** bottom up and out.

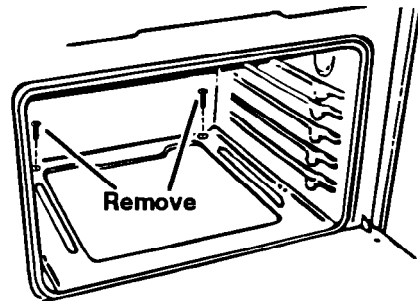

To replace:

1. **Place** oven bottom panel in oven with the back raised about 6 inches or until you can insert the hold-down lip at front of panel under the front frame of oven cavity.
2. **Push** back of oven bottom panel down fully into place on metal flanges on rear wall and **insert** the hold-down screws.

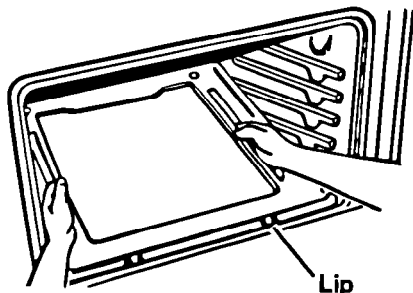

The continuous-cleaning oven

(model SF330PEA)

Standard-cleaning oven walls are coated with smooth porcelain. Your continuous-cleaning oven walls are coated with a special, rougher porcelain. A fat spatter beads up on the smooth surface, but spreads out on the rougher surface. The bead of fat on the smooth surface chars and turns black. The spread-out fat on the rough surface gradually burns away at medium to high baking temperatures so the oven can return to a presentably clean condition.

Fat spatter beads up. Turns black.

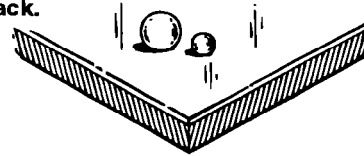

Standard porcelain

Fat spatter spreads out. Burns away.

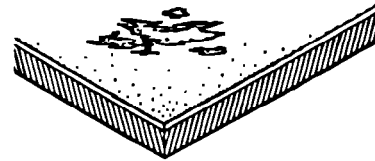

Continuous-cleaning porcelain

Cleaning tips

- **The oven window, racks, oven bottom and inside surface of door are not coated. Clean them by hand.**
- **If you do more broiling than baking, hand-cleaning may be needed.**

Hand-cleaning the continuous-cleaning oven

⚠ WARNING

Personal Injury Hazard

Do not use oven cleaning products in a continuous-cleaning oven. Some could become trapped in the porcelain surface and give off harmful fumes.

WINDOW—Keep clean with warm, soapy water. Use a plastic scrubbing pad for heavily soiled areas. Rinse well. Do not use steel wool or abrasive cleansers.

RACKS—Use a soapy steel-wool pad for best cleaning results. Rinse well.

OVEN BOTTOM AND INSIDE SURFACE OF DOOR—Wash with warm, soapy water. Use a steel-wool pad or plastic scrubbing pad for heavily soiled areas. Rinse well.

Once removed from oven, both oven bottom and inside surface of door can be cleaned with a commercial oven cleaner. (See pages 18 and 19 for removal instructions.)

WALLS—Apply ammonia with sponge. Allow to soak for 15-20 minutes and rinse thoroughly. Do not scrub or use abrasive or harsh cleansers.

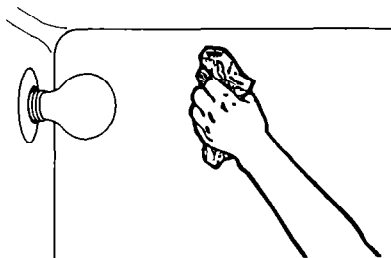
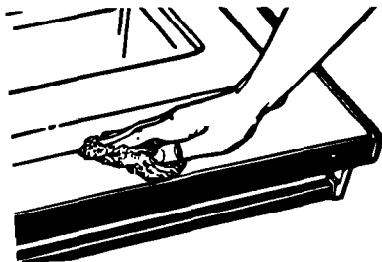
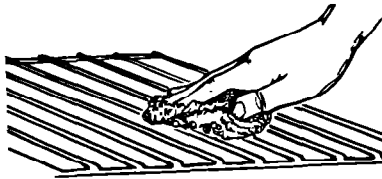
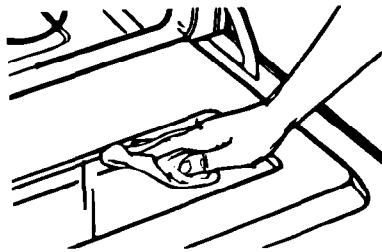
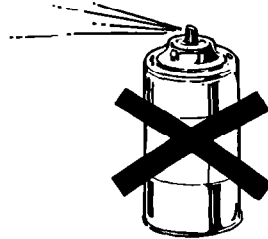

Cleaning chart

Use the following table to help you clean all parts of your range.

PART	WHAT TO USE	HOW TO CLEAN
Control knobs	Sponge and warm, soapy water	<ul style="list-style-type: none"> • Turn knobs to OFF and pull straight away from control panel. • Wash, rinse and dry thoroughly. Do not soak. • Do not use steel wool or abrasive cleansers. They may damage the finish of the knobs. • Replace knobs. Make sure all knobs point to OFF.
Control panels	Sponge and warm, soapy water OR Paper towel and spray glass cleaner	<ul style="list-style-type: none"> • Wash, rinse and dry thoroughly. • Do not use steel wool or abrasive cleansers. They may damage the finish. • Do not spray cleaner directly on panel. Apply cleaner to paper towel.
Exterior surfaces (other than control panels)	Sponge and warm, soapy water	<ul style="list-style-type: none"> • Wash, rinse and dry thoroughly. • Use nonabrasive, plastic scrubbing pad on heavily soiled areas. • Do not use abrasive or harsh cleansers. They may damage the finish. <p>NOTE: Do not allow foods containing acids (such as vinegar, tomato or lemon juice) to remain on surface. Acids may remove the glossy finish. Also wipe up milk or egg spills when cooktop is cool.</p>
Surface burner grates and chrome reflector pans	Dishwasher OR Warm, soapy water and a nonabrasive, plastic scrubbing pad	<ul style="list-style-type: none"> • In dishwasher, wash with other cooking utensils. • Dry completely. • Do not use abrasive or harsh cleansers.

CARING FOR YOUR RANGE

PART	WHAT TO USE	HOW TO CLEAN
Surface burners	<p>Sponge and warm, soapy water</p> <p>Warm, soapy water and a nonabrasive, plastic scrubbing pad OR Vinegar and water solution</p>	<ul style="list-style-type: none"> • Lift up the cooktop. (See page 17.) • Wipe off spills immediately after burner has cooled. <p>For cooked-on food:</p> <ul style="list-style-type: none"> • Remove burner from manifold with Phillips screwdriver. • Wash with warm, soapy water and a plastic scrubbing pad or soak in vinegar and water solution. • Rinse and dry well. • If ports are clogged, clean with a straight pin. Do not enlarge or distort ports. Do not use a wooden toothpick. • Do not clean surface burner in dishwasher.
Broiler drawer, pan and grid (clean after each use)	Steel-wool pad and warm, soapy water	<ul style="list-style-type: none"> • Clean after each use. • Wash, rinse and dry thoroughly. • After broiler is cool, wipe interior with warm, damp sponge. For heavily soiled areas, use a soapy steel-wool pad.
Oven racks	Steel-wool pad and warm, soapy water	<ul style="list-style-type: none"> • Wash, rinse and dry thoroughly.
Oven door glass	<p>Paper towel and spray glass cleaner OR Warm, soapy water and a nonabrasive, plastic scrubbing pad</p>	<ul style="list-style-type: none"> • Make sure oven is cool. • Follow directions provided with the cleaner. • Wash, rinse and dry thoroughly.
Oven cavity (model SF310PEA)	<p>Sponge and warm, soapy water</p> <p>Soapy steel-wool pad for heavily soiled areas OR Commercial oven cleaner for heavily soiled areas</p>	<ul style="list-style-type: none"> • Make sure oven is cool. • Remove door and oven bottom for easier access. (See pages 18 and 19.) • Wash, rinse and dry well. • Remove door for easier access. • Rinse well with water. • Remove door and oven bottom for easier access. • Place newspaper on floor to protect floor surface. • Follow directions provided with the oven cleaner. • Rinse well with clear water. • Use in well-ventilated room.

continued on next page

CARING FOR YOUR RANGE

PART	WHAT TO USE	HOW TO CLEAN
Oven cavity (model SF310PEA)- continued		<ul style="list-style-type: none"> Do not allow commercial oven cleaners to contact the heat seal, thermostat or exterior surfaces of the range. Damage will occur.
Oven cavity (model SF330PEA)	Sponge and warm, soapy water	<ul style="list-style-type: none"> Make sure oven is cool. Remove door for easier access. Clean heavily soiled areas or stains. Rinse well with water. DO NOT USE COMMERCIAL OVEN CLEANERS. Most fat spatters on oven walls and floor will gradually reduce to a presentably clean condition during baking.

The oven light

To turn the light on, press the Oven Light Switch on the backguard.

⚠ WARNING

Electrical Shock and Burn Hazard

Make sure oven and light bulb are cool and power to the range has been turned OFF before replacing the light bulb.

Failure to do so could result in electrical shock or burns.

To replace the oven light:

1. **Unplug** appliance or **disconnect** at main power supply.
2. **Remove** the light bulb from its socket. **Replace** the bulb with a 40-watt appliance bulb.
3. **Plug in** appliance or **reconnect** at the main power supply.

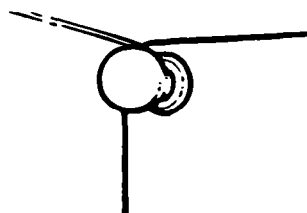

If You Need Assistance Or Service

This section is designed to help you save the cost of a service call. Part 1 of this section outlines possible problems, their causes, and actions you can take to solve each problem. Parts 2 and 3 tell you what to do if you still need assistance or service. When calling our Consumer Assistance Center for help or calling for service, please provide a detailed description of the problem, your appliance's complete model and serial numbers and the purchase date. (See page 2.) This information will help us respond properly to your request.

1. Before calling for assistance ...

Performance problems often result from little things you can find and fix without tools of any kind. Please check the chart below for problems you can fix. It could save you the cost of a service call.

PROBLEM	POSSIBLE CAUSE	SOLUTION
Nothing will operate	<p>The power cord is not plugged into a live circuit with proper voltage.</p> <p>Range is not properly connected to gas supply.</p> <p>A household fuse has blown or a circuit breaker has tripped.</p> <p>Controls are not set correctly.</p> <p>The flow of combustion and/or ventilation air to the range is blocked.</p>	<p>Plug the power cord into a live circuit with proper voltage. (See Installation Instructions.)</p> <p>Contact an authorized Whirlpool® service technician to reconnect range to gas supply. (See Installation Instructions.)</p> <p>Replace household fuse or reset circuit breaker.</p> <p>Reset controls, if needed.</p> <p>Remove blockage to airflow to and around range.</p>
The oven will not operate	<p>The Oven Temperature Control is not turned to a temperature setting.</p>	<p>Push in and turn the Oven Temperature Control to a temperature setting.</p>
Burner fails to light	<p>The power cord is not plugged into a live circuit with proper voltage.</p> <p>A household fuse has blown or a circuit breaker has tripped.</p> <p>Burner ports are clogged.</p>	<p>Plug the power cord into a live circuit with proper voltage. (See Installation Instructions.)</p> <p>Replace household fuse or reset circuit breaker. In case of prolonged power failure, manually light burners (see page 8).</p> <p>Clean with a straight pin (see pages 17 and 23).</p>
Burner flames are uneven	<p>Burner ports are clogged.</p>	<p>Clean with a straight pin (see pages 17 and 23). If this fails, call an authorized Whirlpool® service technician for service.</p>

continued on next page

IF YOU NEED ASSISTANCE OR SERVICE

PROBLEM	POSSIBLE CAUSE	SOLUTION
Burner flames lift off ports, are yellow, or are noisy when turned off	Air/gas mixture is incorrect.	Contact an authorized Whirlpool® service technician to check air/gas mixture.
Burner makes popping noise when on	Burner is wet from washing.	Let dry.
Control knob(s) will not turn	You are not pushing in before turning.	Push control knob(s) in before turning to a setting.
Soil is visible on continuous-cleaning oven finish	You broil often. Soil is on door. Soil is caused by sugar and starchy spills.	The special finish is designed to gradually reduce oven soil during normal baking or roasting. It is not designed to keep your oven spotless, only presentably clean. If you broil often, you may see oven soil. Follow hand-cleaning tips on page 21. The door is cooler than the oven walls. Soil will be more visible on the door than other areas in the oven. See hand-cleaning tips on page 21. Sugar and starchy spills may leave stains. See page 21 for hand-cleaning tips.
Cooking results are not what you expected	The range is not level. The oven temperature seems too low or too high. The oven was not preheated as the recipe calls for. The recipe has never been tested or is not from a reliable source. The pans are not the type or size recommended in the recipe. There is not proper air circulation around pan when baking. Flame size does not fit the cooking utensil being used.	Level range. (See Installation Instructions.) Adjust the oven temperature control. (See "Adjusting the oven temperature control" on page 13.) Preheat oven if called for in recipe. Use only tested recipes from a reliable source. Refer to a reliable cookbook for recommended pan type and size. Allow 1½ to 2 inches (4-5 cm) on all sides of the pans for air circulation. There must be a minimum space of 1 inch (2.5 cm). Adjust flame size to fit cooking utensil.

IF YOU NEED ASSISTANCE OR SERVICE

PROBLEM	POSSIBLE CAUSE	SOLUTION
Cooking results are not what you expected (continued)	When broiling, you have not completely closed the broiler drawer.	Completely close broiler drawer.
The display is showing "88:88"	There has been a power failure.	Reset the clock. (See page 10.)

2. If you need assistance ...

Call Whirlpool Consumer Assistance Center telephone number. Dial toll-free from anywhere in the U.S.A.:

1-800-253-1301

and talk with one of our trained consultants. The consultant can instruct you in how to obtain satisfactory operation from your appliance or, if service is necessary, recommend a qualified service company in your area.

If you prefer, write to:

Mr. William Clark
Consumer Assistance Representative
Whirlpool Corporation
2000 North M-63
Benton Harbor, MI 49022-2692

Please include a daytime phone number in your correspondence.

3. If you need service ...



Whirlpool has a nationwide network of authorized Whirlpool® service companies.

Whirlpool service technicians are trained to fulfill the product warranty and provide after-warranty service, anywhere in the United States. To locate the authorized Whirlpool service company in your area, call our Consumer Assistance Center telephone number (see Step 2) or look in your telephone directory Yellow Pages under:

• **APPLIANCE-HOUSEHOLD-MAJOR, SERVICE & REPAIR**
- See: Whirlpool Appliances or Authorized Whirlpool Service
(Example: XYZ Service Co.)

• **WASHING MACHINES & DRYERS, SERVICE & REPAIR**
- See: Whirlpool Appliances or Authorized Whirlpool Service
(Example: XYZ Service Co.)

4. If you need FSP® replacement parts ...

FSP is a registered trademark of Whirlpool Corporation for quality parts. Look for this symbol of quality whenever you need a replacement part for your Whirlpool® appliance. FSP replacement parts will fit right and work right, because they are made to the same exacting specifications used to build every new Whirlpool appliance.

To locate FSP replacement parts in your area, refer to Step 3 above or call the Whirlpool Consumer Assistance Center number in Step 2.

5. If you are not satisfied with how the problem was solved ...

- Contact the Major Appliance Consumer Action Panel (MACAP). MACAP is a group of independent consumer experts that voices consumer views at the highest levels of the major appliance industry.
- Contact MACAP only when the dealer, authorized servicer and Whirlpool have failed to resolve your problem.
Major Appliance Consumer Action Panel
20 North Wacker Drive
Chicago, IL 60606
- MACAP will in turn inform us of your action.

WHIRLPOOL® Gas Range Warranty

LENGTH OF WARRANTY	WHIRLPOOL WILL PAY FOR
FULL ONE-YEAR WARRANTY From Date of Purchase	FSP® replacement parts and repair labor to correct defects in materials or workmanship. Service must be provided by an authorized Whirlpool service company.
WHIRLPOOL WILL NOT PAY FOR	
<p>A. Service calls to:</p> <ol style="list-style-type: none"> 1. Correct the installation of your range. 2. Instruct you how to use your range. 3. Replace house fuses or correct house wiring or plumbing. 4. Replace owner accessible light bulbs. <p>B. Repairs when your range is used in other than normal, single-family household use.</p> <p>C. Pickup and delivery. Your range is designed to be repaired in the home.</p> <p>D. Damage to your range caused by accident, misuse, fire, flood, acts of God or use of products not approved by Whirlpool.</p> <p>E. Repairs to parts or systems caused by unauthorized modifications made to the appliance.</p>	

593

WHIRLPOOL CORPORATION SHALL NOT BE LIABLE FOR INCIDENTAL OR CONSEQUENTIAL DAMAGES. Some states do not allow the exclusion or limitation of incidental or consequential damages, so this limitation or exclusion may not apply to you. This warranty gives you specific legal rights, and you may also have other rights which vary from state to state.

Outside the United States, a different warranty may apply. For details, please contact your authorized Whirlpool distributor or military exchange.

If you need service, first see the "If You Need Assistance Or Service" section of this book. After checking "If You Need Assistance Or Service," additional help can be found by calling our Consumer Assistance Center telephone number, 1-800-253-1301, from anywhere in the U.S.A.



Printed on recycled paper—
10% post-consumer waste
50% recovered materials

PART NO. 316000723/4372184 Rev. A

© 1994 Whirlpool Corporation

© Registered Trademark/TM Trademark of Whirlpool, U.S.A.

Printed in U.S.A.