

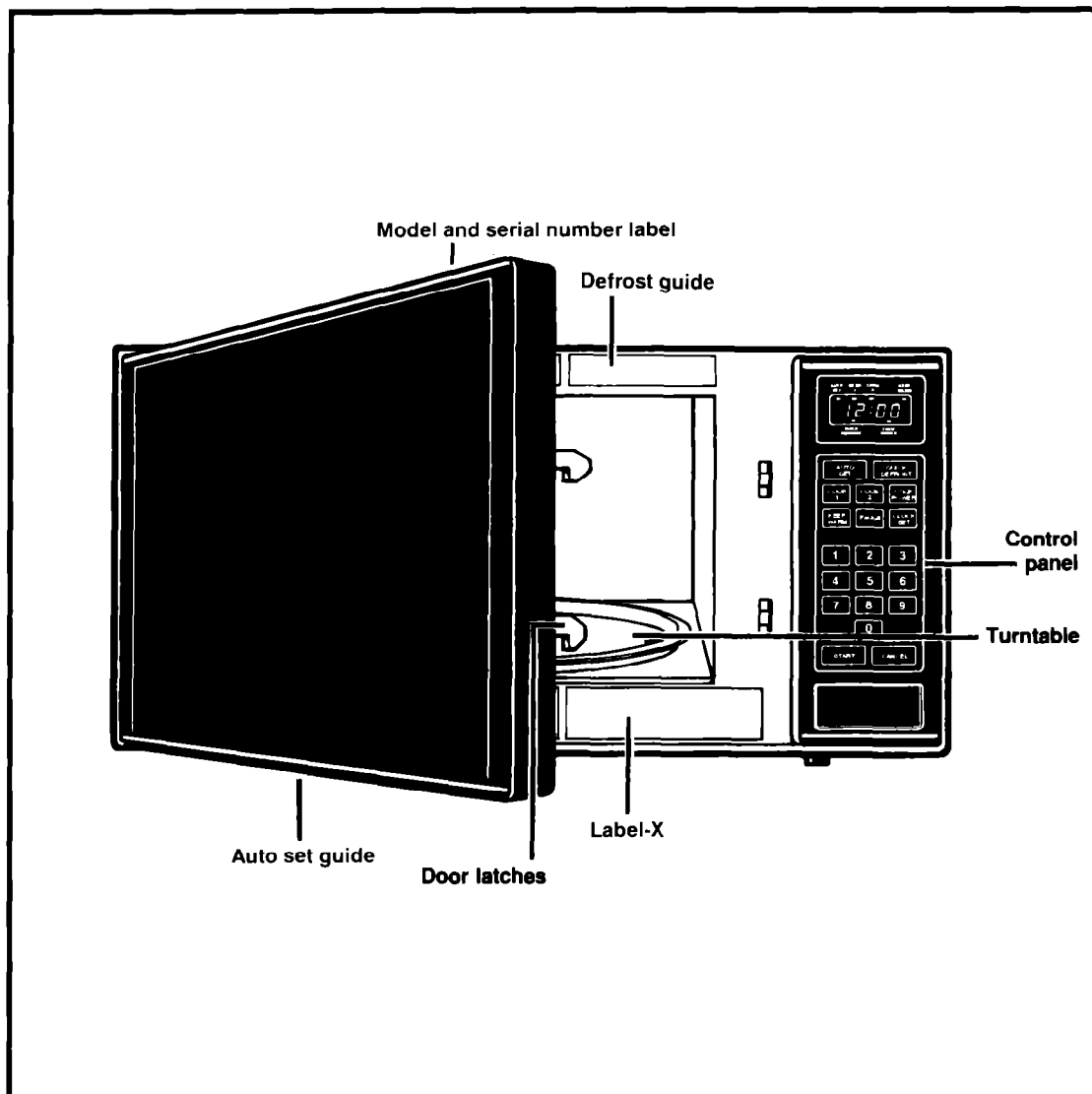

Use & Care Guide



MICROWAVE OVEN
MT1850XW
MT1851XW

Contents

	Page
Important Safety Instructions	3
Precautions To Avoid Possible Exposure To Excessive Microwave Energy	4
Getting Acquainted	5
Microwave oven features	5
Control panel features	6
Quick reference cooking guide	7
Using Your Microwave Oven	9
Microwave oven controls	9
Audible signals	10
Setting the clock	10
Cooking in your microwave oven	11
Cooking at high cook power	12
Cooking at lower cook powers	13
Using AUTO SET	14
Defrosting	16
Cooking automatically after defrosting	18
Cooking in more than one cook cycle	20
Using PAUSE	23
Using KEEP WARM	26
Using the Minute Timer	27
Using delayed start	28
Other operating hints	29
Installation Instructions	30
Caring For Your Microwave Oven	32
Cleaning the microwave oven	32
How Your Microwave oven Works	33
Operating Safety Precautions	34
Glass turntable	36
If You Need Service Or Assistance	38
Cooking Guide	40
Whirlpool Microwave Oven Warranty	68

© 1990 Whirlpool Corporation

If your Microwave oven has a Consumer Buy Guide label, remove it. It will be easier to remove before the oven is used. To remove any remaining glue:

- Rub briskly with thumb to make a ball, then remove.
or
- Soak area with liquid hand dishwashing detergent before removing glue as described above.

Do not use sharp instruments, rubbing alcohol, flammable fluids or abrasive cleaners. These can damage the finish. See "Important Safety Instructions" on page 3.

Thank you for buying a Whirlpool appliance. Please complete and mail the Owner Registration Card provided with this product. Then complete the form below. Have this information ready if you need service or call with a question.

- Copy model and serial numbers from label (behind the microwave oven door on the frame) and purchase date from sales slip.
- Keep this book and the sales slip together in a handy place.

Model Number

Serial Number

Purchase Date

Service Company Phone Number

Fill out and return the Microwave Registration Card included with your microwave oven. If the card is missing, please send the model and serial number of your microwave oven, with your name and address to . . .

Whirlpool Corporation
 Microwave Registration Department
 Administrative Center
 2000 M-63
 Benton Harbor, Michigan 49022

This information will help us reach you if there is ever a need to pass along information about your microwave oven.

Important Safety Instructions

Microwave ovens have been thoroughly tested for safe and efficient operation. However, as with any appliance, there are special installation and safety precautions which must be followed to ensure safe and satisfactory operation and prevent damage to the unit.

⚠ WARNING

To reduce the risk of fire, electrical shock, injury to persons, or damage when using the microwave oven, follow basic precautions, including the following:

- Read all instructions before using the microwave oven.
- Read and follow the specific "Precautions To Avoid Possible Exposure To Excessive Microwave Energy" found on page 4.
- This appliance must be grounded. Connect only to properly grounded outlet. See Grounding Instructions found on page 31.
- Install or locate this appliance only in accordance with the provided Installation Instructions found on page 30.
- Some products such as whole eggs and sealed containers - for example, closed glass jars - may explode and should not be heated in this oven.
- Use this appliance only for its intended use as described in this manual.
- As with any appliance, close supervision is necessary when used by children.
- Do not operate this appliance if it has a damaged cord or plug, if it is not working properly, or if it has been damaged or dropped. Electrical shock, fire or other hazards may result.
- This appliance should be serviced only by qualified service personnel. Call an authorized WhirlpoolSM service company for examination, repair or adjustment.
- Do not cover or block any opening on the appliance. Fire may result.
- Do not use outdoors. Damage to the oven or electrical shock may result.
- Do not immerse cord or plug in water. Electrical shock may result.
- Keep cord away from heated surfaces. Electrical shock may result.
- Do not let cord hang over edge of table or counter. Electrical shock may result.
- See door surface and interior cleaning instructions on page 32
- To reduce the risk of fire in the oven cavity:
 - Do not overcook food. Carefully attend appliance if paper, plastic, or other combustible materials are placed inside the oven to facilitate cooking. Paper can char or burn, and some plastics can melt if used when heating foods.
 - Do not deep fry in oven.
 - Test dinnerware or cookware before using.** See page 37. Some dishes (melamine, Centura[®], etc.) absorb microwave energy, becoming too hot to handle and slowing cooking times. Remove wire twist-ties from paper or plastic bags before placing bag in oven. Cooking in metal containers can damage the oven. So can containers with hidden metal (twist-ties, foil lining, staples, metallic glaze or trim.)
 - If materials inside the oven should ignite, keep oven door closed, turn oven off, and disconnect the power cord, or shut off power at the fuse or circuit breaker panel.
- Do not heat, store or use flammable materials in or near the oven. Fumes can create a fire hazard or explosion.
- Read and follow "Operating Safety Precautions" starting on page 34.

-SAVE THESE INSTRUCTIONS-

You are responsible for:

- Installing and leveling the oven on a surface strong enough to support its weight, and where it is protected from the elements.* The microwave oven should be at a temperature above 50°F (10°C) for proper operation.
 - Properly connecting the oven to electrical supply and grounding it.*
 - Operating the oven with the turntable in place.
 - Making sure the oven is not used by anyone unable to operate it properly.
 - Properly maintaining the oven.
 - Using the microwave oven only for jobs expected of a home microwave oven.
- * See the Installation Instructions.

Precautions To Avoid Possible Exposure To Excessive Microwave Energy...

Do not attempt to operate this oven with the door open since open-door operation can result in harmful exposure to microwave energy. It is important not to defeat or tamper with the safety interlocks.

Do not place any object between the oven front face and the door or allow soil or cleaner residue to accumulate on sealing surfaces.

Do not operate the oven if it is damaged. It is particularly important that the oven door close properly and that there is no damage to the:

- (1) Door (bent),
- (2) Hinges and latches (broken or loosened),
- (3) Door seals and sealing surfaces.

Do not operate the microwave oven if the door window is broken.

The microwave oven should be checked for microwave leakage by qualified service personnel after a repair is made.

The oven should not be adjusted or repaired by anyone except properly qualified service personnel.

Do not operate the microwave oven with the outer cabinet removed.

Getting Acquainted

Microwave oven features

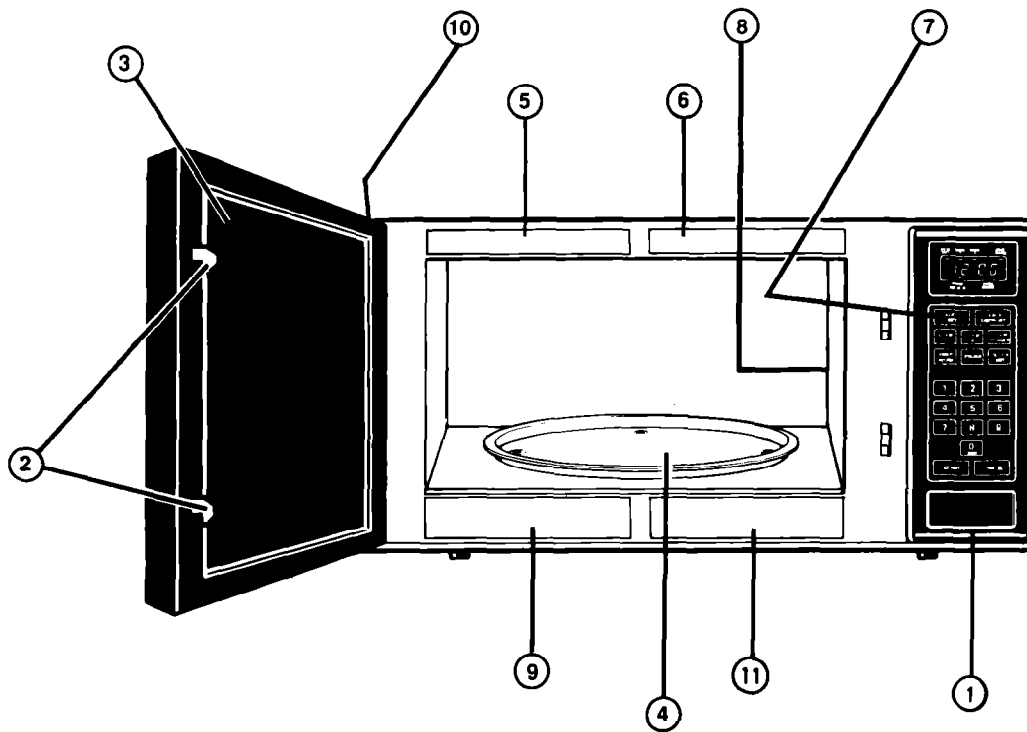

Your microwave oven is designed to make your cooking experience as enjoyable and productive as possible. To help get you up and running quickly, the following is a list of the oven's basic features:

- 1. Door Button.** Door must be pressed firmly shut for oven to operate.
- 2. Door Safety Lock System.**
- 3. Window with Metal Shield.** Shield prevents microwaves from escaping. It is designed as a screen to allow you to view food as it cooks.
- 4. Glass Turntable.** This turntable turns food as it cooks for more even cooking. It must be in oven during operation for best cooking results. See page 36 for more details.
- 5. Model and Serial Number Label.**
- 6. Defrost Guide.**
- 7. Control Panel.** Touch pads on this panel to perform all functions. See page 6 for more details.
- 8. Light.** Automatically turns on when oven is operating.
- 9. Auto Set Guide.**
- 10. External Oven Air Vents.**
- 11. Label-X.**

Control panel features

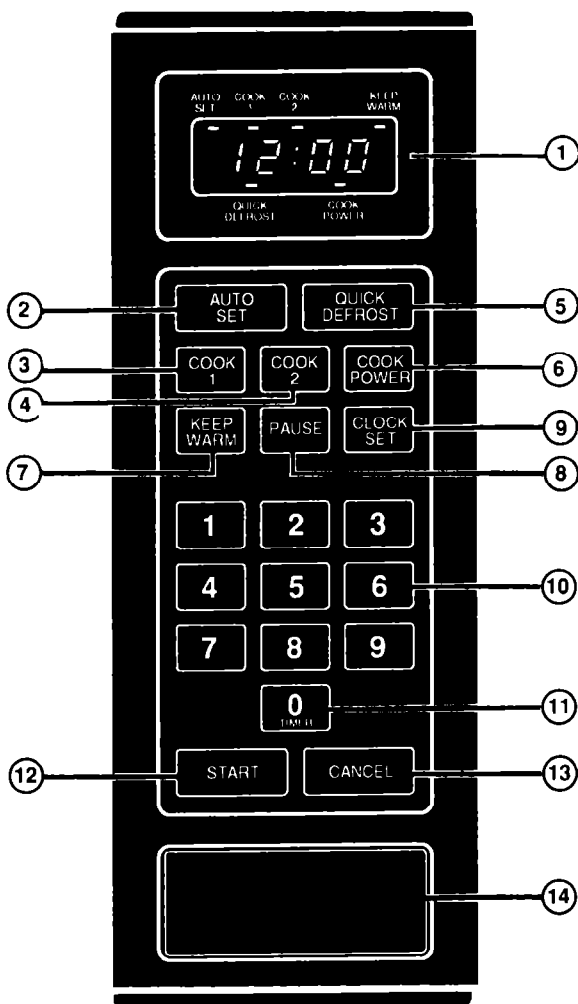

Your microwave oven control panel lets you select the desired cooking function quickly and easily. All you have to do is touch the necessary Command Pad. The following is a list of all the Command and Number Pads located on the control panel. For more information, see pages 9-29.

1. **Digital Display.** This display includes clock and indicator lights to tell you time of day, cooking time settings and cooking functions selected. See page 9 for more information.
2. **AUTO SET.** Touch this pad to select up to ten preset cooking times, at the Cook Powers of your choice. AUTO SET provides a short-cut method for setting commonly-used cooking times. See pages 14 -16 for more information.

3. **COOK 1.** Touch this pad when cooking at only one Cook Power or cooking automatically after defrosting. Touch COOK 1 to set the first Cook cycle when cooking at more than one Cook Power. This Command Pad is also the first pad touched when setting the Minute Timer or a delayed start time. See pages 12, 13, 18, 20, 27 and 28 for more information.
4. **COOK 2.** Touch this pad to set the second Cook cycle when cooking at more than one Cook Power. Also use this pad to change standing time and to set the Cook cycle after a delayed start time has been set with COOK 1. See pages 17, 20 and 28 for more information.
5. **QUICK DEFROST.** Touch this pad followed by Number Pads to thaw frozen food before cooking. See pages 16-17 for more information.
6. **COOK POWER.** Touch this pad followed by a Number Pad to set the amount of microwave energy released to cook the food. The higher the number, the higher the power or "heat". See page 13 for more information. See Cooking Guide on page 40 for specific Cook Powers to use for the foods you are cooking.
7. **KEEP WARM.** Touch this pad to keep food warm for up to 99 minutes, 99 seconds. See page 26 for more information.
8. **PAUSE.** Touch this pad when you want the oven to pause between Cook cycles. Pausing between cycles gives you time to stir, turn over or rearrange the food, or to add ingredients. See pages 23-25 for more information.
9. **CLOCK SET.** Touch this pad followed by Number Pads to set time of day. See pages 10-11 for more information.
10. **Number Pads.** Touch a Number Pad after touching a Command Pad to tell the oven what time or Cook Power you wish to enter.
11. **"0" Number Pad.** Touch this Number Pad when setting the Minute Timer or Delayed Start. See pages 27-29 for more information.
12. **START.** Touch this pad after setting a function on the microwave oven to start the function.
13. **CANCEL.** Touch this pad once to stop the oven or to cancel a reminder tone. Touch it twice to remove the programming tone, reminder tone and Minute Timer signal completely. See page 10 for more information.
14. **DOOR OPEN BUTTON.**

Quick reference cooking guide

Your microwave oven gives you a wide range of cooking capabilities. The following chart can be used as a quick reference when cooking. For more in-depth information, see the corresponding sections in this Use and Care Guide.

Type of cooking	How you use it	Why you use it
High power cooking	<ol style="list-style-type: none"> 1. Put food in the oven and close the door. 2. Touch COOK 1. 3. Touch Number Pads for the cooking time you want. 4. Touch START. 	This mode is useful for quick cooking of small items and separate portions.
Lower power cooking (cook powers 1-9)	<ol style="list-style-type: none"> 1. Put food in the oven and close the door. 2. Touch COOK 1. 3. Touch Number Pads for the cooking time you want. 4. Touch COOK POWER. 5. Touch a Number Pad for the Cook Power you want. 6. Touch START. 	This mode is necessary for efficient cooking of most foods. Failure to use the correct Cook Power may result in over- or under-cooking.
Auto Set	<ol style="list-style-type: none"> 1. Put food in the oven and close the door. 2. Touch AUTO SET. 3. Touch a Number Pad for the cooking time you want, from 1 to 9 minutes. 4. Touch COOK POWER. 5. Touch a Number Pad for the Cook Power you want. 6. Touch START. 	This mode lets you select up to ten commonly-used cooking times by touching only one Number Pad for each time.
Defrosting	<ol style="list-style-type: none"> 1. Put food in the oven and close the door. 2. Touch QUICK DEFROST. 3. Touch Number Pads for the defrosting time you want. 4. Touch START. 	This mode decreases the amount of time needed to thaw frozen food before cooking.
Two-cycle cooking	<ol style="list-style-type: none"> 1. Put food in the oven and close the door. 2. Touch COOK 1. 3. Touch Number Pads for the cooking time you want. 4. Touch COOK POWER. (To use HIGH power, skip to Step 6.) 5. Touch a Number Pad for the Cook Power you want in the first cycle. 6. Touch COOK 2. 7. Touch Number Pads for the cooking time you want in the second cycle. 8. Touch COOK POWER. (If you want to use HIGH power, skip to Step 10.) 9. Touch a Number Pad for the Cook Power you want in the second cycle. 10. Touch START. 	This mode lets you cook at two different Cook Powers, one after another. Using this mode lets you fine-tune your cooking for better results.

continued on next page

**Getting Acquainted
Continued**

Type of cooking	How you use it	Why you use it
Pause	<ol style="list-style-type: none"> 1. Put food in the oven and close the door. 2. Touch in the desired cooking instruction for COOK 1. 3. Touch PAUSE. 4. Touch in the desired cooking instructions for COOK 2. 5. Touch START. 	<p>This mode lets you set the oven to pause between cycles for stirring, turning over or rearranging food, as well as for adding ingredients.</p>
Keep warm	<ol style="list-style-type: none"> 1. Put cooked, hot food in the oven and close the door. 2. Touch KEEP WARM. 3. Touch START. 	<p>This mode lets you keep food warm in your microwave oven for about 1 hour, 40 minutes.</p>
Delayed start	<ol style="list-style-type: none"> 1. Put in food and close the door. 2. Touch COOK 1. 3. Touch Number Pads for the length of delay you want. 4. Touch COOK POWER. 5. Touch "0" Number Pad. 6. Touch COOK 2. 7. Touch in the cooking time and Cook Power. 8. Touch START. 	<p>This mode lets you set the microwave oven to start automatically at a later time.</p>

Using Your Microwave Oven

Microwave oven controls

There are three parts in the control section:

- Digital Display/Clock and Indicator Lights
- Command Pads
- Number Pads

Instructions for each control are covered on the following pages. Read them carefully.

When you first plug in the oven, a tone will sound and the Display will show **88:88**. If after you set the Clock (pages 10-11), the Display again shows all 8's, it means your electricity was off for a while. Reset the Clock.

Digital display/clock and indicator lights

When you are not using the microwave oven, this is an accurate digital clock.

When you are using the microwave oven, it displays time settings, temperature settings, and Indicator Lights.



Command pads

Touch Command Pads to tell the microwave oven what to do and in what order. A few examples:

- CLOCK SET tells the oven you are going to set the clock.
- START tells the oven to start.

(See page 10 for information on the tone you hear when touching any pad.)

Each Command Pad (except START, CANCEL, and CLOCK SET) lights an Indicator Light when you touch the Command Pad.

While the oven is running, an Indicator Light (or lights) will be on to show what the oven is doing.

Number pads

Once you've touched a Command Pad to tell the oven what you want it to do, you'll touch Number Pads to tell it...

- a time,
- a Cook Power.

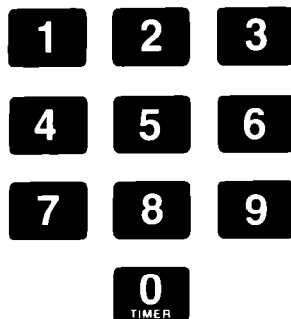

Audible signals

Audible signals are available to guide you when setting and using your oven. A programming tone will sound each time you touch a pad. Two beeps will sound between cycles. A reminder tone will sound every 30 seconds after cooking is done to remind you that something has been left in the oven. Four beeps signal the end of the Minute Timer function and a Cook or Defrost cycle. If you don't hear a tone, it is because of incorrectly entered instructions or because the tones have been removed. For example, a tone will not sound if you touch a Number Pad before you touch a Command Pad.

To remove the programming tone:

1. Open the door.
2. Touch CANCEL **twice**, then touch START.
3. Programming tones will be cancelled.

To replace the tones:

- Repeat the steps above.

To remove all tones:

1. Open the door.
2. Touch CANCEL **twice**, touch 0, then touch START.
3. All audible tones (including Minute Timer signal) will be cancelled.

NOTE: Do not remove all tones if you use the Minute Timer.

To replace the tones:

- Repeat the steps above.

NOTE: If your electricity goes off, the audible signals will come back on. Repeat steps above if you want to remove them again.

Setting the clock

When the oven is first plugged in, a tone sounds and the Display shows **88:88**. If the electric power ever goes off, the Display will again show all 8's when the power comes back on.

You can cook without setting the clock, but the Display will be blank after cooking.

1. Touch CLOCK SET. The Display will show a "0" and the colon will start to flash. **The first Number Pad must be touched within 5 seconds or the Display will go blank.** If the Display goes blank, touch CLOCK SET again and continue.

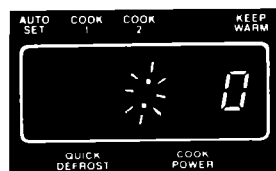
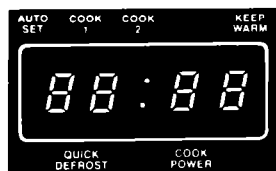

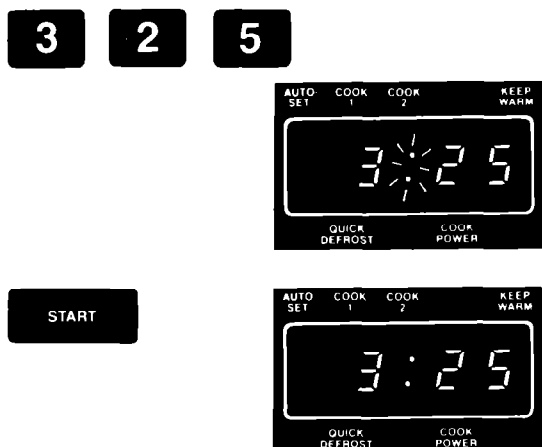

2. Touch Number Pads for the correct time of day. The Display will show what numbers you touched **in the order you touched them**. This example shows 3:25.

3. Touch START. The colon will stop flashing. The Clock is set.

If you have touched in an incorrect time, such as 12:65, "Err" will show on the Display. Touch CLOCK SET and start over.

NOTE: To reset the clock, touch CLOCK SET. The current time will show on the Display and the colon will flash. Continue to set the clock as shown above.

Cooking in your microwave oven

Important things to remember to get the best cooking results.

- ALWAYS cook food for the minimum recommended cooking time. If necessary, add time in one or two minute periods, then check for doneness to avoid overcooking the food.
- Stir, turn over or rearrange the food being cooked about halfway through the cooking time for most even doneness with all recipes.
- If a glass cover is not available, use waxpaper, paper towels or microwave approved plastic wrap. Turn back a corner to vent steam during cooking.
- ALWAYS cook food with turntable in place.

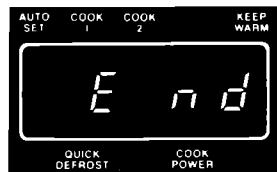
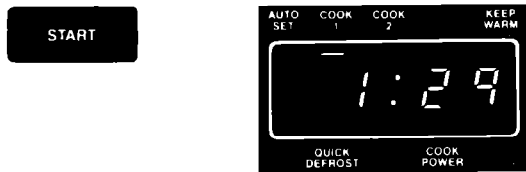
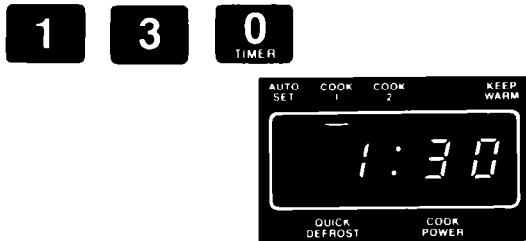

Cooking at high cook power

Follow these steps to cook at **HIGH power**:

1. Put food in the oven and close the door.
2. Touch COOK 1. The COOK 1 Indicator Light will come on and the Display will show four 0's.

3. Touch Number Pads for the cooking time you want. The Display will show the numbers you touched **in the order you touched them**. The example shows 1 minute, 30 seconds.

4. Touch START. The oven will automatically cook at HIGH Cook Power.

The COOK 1 Indicator Light will stay on to show that the oven is cooking in the first cycle.

The Display counts down the time to show how much time is left in the first cycle.

When the cooking time ends, "End" will show on the Display and 4 beeps will sound. (You can stop the beeping by opening the door or by touching CANCEL.) "End" will remain on the Display and a reminder tone will sound every 30 seconds (to remind you that food is left in the oven) until the door is opened or CANCEL is touched. The Display will then show the time of day.

Changing the cooking time

Cooking time can be changed any time before or after touching START:

1. Touch COOK 1.
2. Touch numbers for the new time.
3. Touch START.
Cook 1 cycle will continue cooking for the new time.

Cooking at lower cook powers

For best results, some recipes call for lower Cook Powers. The lower the Cook Power, the slower the cooking. Each Number Pad also stands for a different percentage of Cook Power. Many recipes in the Cooking Guide tell you, by number, which Cook Power to use. Recipes in other books and magazines may tell you by name (HI, MED, LO, etc.) or percentage (10%, 50%, 80%, etc.).

The following chart gives the percentage of Cook Power each Number Pad stands for, and Cook Power name usually used:

automatic 100% of full power HIGH
 9 = 90% of full power
 8 = 80% of full power
 7 = 70% of full power MED-HIGH
 6 = 60% of full power
 5 = 50% of full power MED
 4 = 40% of full power
 3 = 30% of full power MED-LOW
 2 = 20% of full power
 1 = 10% of full power LOW
 0 = TIMER (fan and light will be off)

1. Put food in the oven and close the door.
2. Touch COOK 1. The COOK 1 Indicator Light will come on and the Display will show four 0's.

COOK
1



7

3

0
TIMER

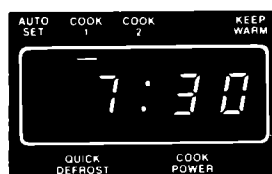

3. Touch Number Pads for the cooking time you want. The Display will show the numbers you touched **in the order you touched them**. This example shows 7 minutes, 30 seconds.

COOK
POWER

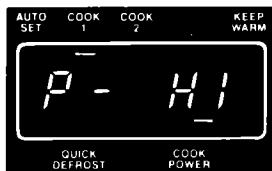

4. Touch COOK POWER. The COOK POWER Indicator Light will come on and the Display will show "P-HI". This shows the oven is pre-programmed to cook at full (HIGH) power.

5



5. Touch a Number Pad for the Cook Power you want. The Display will show what you touched. This example shows you touched Number Pad 5 for 50% of full power.

Using Your Microwave Oven Continued

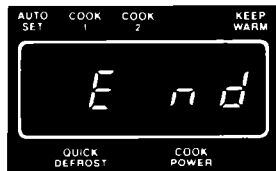
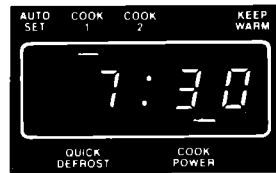

BEEP BEEP BEEP BEEP

6. Touch START. The COOK 1 and COOK POWER Indicator Lights will stay on to show that the oven is cooking in the first cycle at a Cook Power other than HIGH.

The Display counts down the time to show how much cooking time is left in the first cycle.

For 2 of every 10 seconds, the Display will show the Cook Power you selected.

When the cooking time ends, "End" will show on the Display and 4 beeps will sound. (You can stop the beeping by opening the door or by touching CANCEL.) "End" will remain on the Display and a reminder tone will sound every 30 seconds (to remind you that food is left in the oven) until the door is opened or CANCEL is touched. The Display will then show the time of day.

Changing the cook power

The **Cook Power** can be changed any time before or after touching START:

1. Touch COOK POWER.
 2. Touch a Number Pad for the new Cook Power.
 3. Touch START. The cycle will cook at the new Cook Power for the original time.
- OR..**
1. Touch COOK POWER **twice** if you want to change a lower Cook Power to HIGH.
 2. Touch START.

Using AUTO SET

Auto Set provides ten preset times. One to nine minutes at HIGH Cook Power can be selected by touching AUTO SET and the corresponding Number Pad (1-9). You don't need to touch any additional Number Pads as you do when using COOK 1 or COOK 2. This provides a short-cut method for setting commonly used cooking times.

The AUTO SET chart included with your microwave oven and the AUTO SET guide on the inner door panel helps you cook various food items without having to look up the cooking times.

A preset time of 2 minutes, 30 seconds at HIGH Cook Power is available by touching just the AUTO SET pad. The time may be changed to any time from 0-99 minutes, 0-99 seconds, allowing you to store your favorite cooking time and Cook Power, or to preprogram the oven for someone else to cook an already prepared dish at a later time. See page 16 for instructions.

AUTO SET



4



COOK POWER

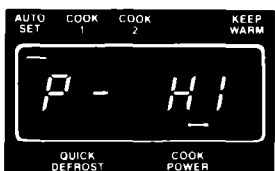

5



START



BEEP BEEP BEEP BEEP

1. Put food in the oven and close the door.
2. Touch AUTO SET. (Option: Skip to Step 6 if you want to use the preset cooking time and Cook Power.) The AUTO SET Indicator Light will come on and the Display will show 2 minutes, 30 seconds (or the time you have set as your favorite cycle).

3. Touch a Number Pad for the new cooking time you want from 1 to 9 minutes. The Display will show what you touched in even minutes. This example shows 4 minutes.

4. Select a Cook Power. To cook at HIGH power, skip to Step 6. To select another Cook Power, touch COOK POWER. The COOK POWER Indicator Light will come on and the Display will show "P-HI". This shows the oven is preprogrammed to cook at full (HIGH) power.

5. Touch a Number Pad for the Cook Power you want. The Display will show what you touched. This example shows you touched Number Pad 5 for 50% of full power.

6. Touch START. The AUTO SET Indicator Light will stay on while the oven is cooking in the preprogrammed cycle. If you selected a Cook Power other than HIGH, the Cook Power Indicator Light will also come on.

The Display counts down the time to show how much cooking time is left.

For 2 of every 10 seconds, the Display will show the Cook Power you selected, if you are using a Cook Power other than HIGH.

When the Auto Set ends, "End" will show on the Display and 4 beeps will sound. (You can stop the beeping by opening the door or by touching CANCEL.) "End" will remain on the Display and a reminder tone will sound every 30 seconds (to remind you that food is left in the oven) until the door is opened or CANCEL is touched. The Display will then show the time of day.

NOTE: You can set COOK 1 or COOK 1 and 2 to follow Auto Set, (see pages 20-22 for instructions).

Using Your Microwave Oven Continued

Changing the preprogrammed setting

You can change the preprogrammed cooking time and Cook Power in AUTO SET to the time and power you most often use. To change the AUTO SET setting, follow these steps:

1. Touch AUTO SET twice.
2. Touch the Number Pads for the new desired cooking time. If HIGH Cook Power is desired, skip to Step 5.
3. Touch COOK POWER.
4. Touch the Number Pad for the desired Cook Power.
5. Touch AUTO SET. Touch CANCEL. The oven will remember that time and Cook Power for future use.

NOTE: If electric power ever goes off, the oven will go back to the preprogrammed 2 minutes, 30 seconds at HIGH Cook Power setting.

Defrosting

Use QUICK DEFROST to thaw frozen food before cooking. For suggested defrost times, see the guide behind the oven door.

1. Put frozen food in the oven and close the door.
2. Touch QUICK DEFROST. The QUICK DEFROST Indicator Light will come on and the Display will show four 0's.

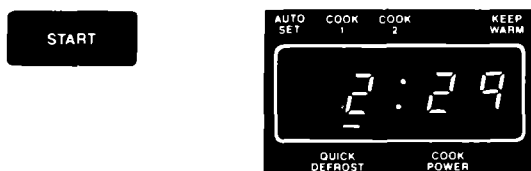
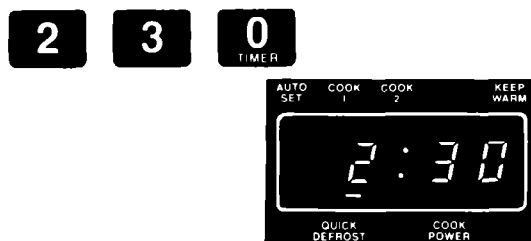
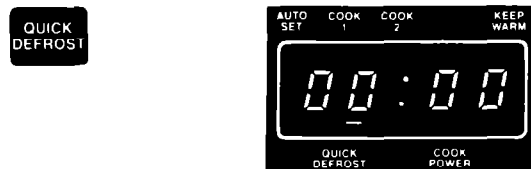

BEEP BEEP BEEP BEEP

3. Touch Number Pads for the defrosting time you want. The Display will show the numbers you touched **in the order you touched them**. This example shows 2 minutes, 30 seconds.

4. Touch START. The QUICK DEFROST Indicator Light will stay on to show that the oven is in the Quick Defrost cycle.

The Display counts down the time to show how much defrosting time is left.

When the defrost time ends, "End" will show on the Display and 4 beeps will sound. (You can stop the beeping by opening the door or by touching CANCEL.) "End" will remain on the Display and a reminder tone will sound every 30 seconds (to remind you that food is left in the oven) until the door is opened or CANCEL is touched. The Display will then show the time of day.

Using PAUSE with QUICK DEFROST

If the defrosting instructions call for stirring or turning over the food in the middle of the defrost cycle, program PAUSE after QUICK DEFROST. See pages 24-25 for more information.

Standing time after defrosting

For best results, allow the food to stand for a while after defrosting. This helps equalize the temperature of the food to provide more even defrosting.

When COOK 1 follows QUICK DEFROST, the oven automatically provides a standing time equal to the time touched in for QUICK DEFROST. COOK 1 will begin after the automatic standing time. See "Cooking automatically after defrosting," page 18.

For a different standing time:

1. Touch QUICK DEFROST and the desired time.
2. Touch COOK 2.
3. Touch Number Pads for the desired standing time.
4. Touch COOK POWER.
5. Touch "0" for zero Cook Power.
6. Touch START.

When QUICK DEFROST is over, the oven will shut off. Two beeps will sound. The Display will count down the new standing time programmed.

About the Quick Defrost cycle

The microwave oven automatically divides the time set for the Quick Defrost cycle into three equal parts:

First part.....80% of full Cook Power
 Second part.....50% of full Cook Power
 Third part.....20% of full Cook Power

This automatic step-down in Cook Power helps defrost food quickly and completely.

Changing or adding defrost time

You can change the defrosting time any time before or after touching START.

1. Touch QUICK DEFROST.
2. Touch Number Pads for new time.
3. Touch START.

Any new time setting made while Quick Defrost is operating will continue the defrosting at only 20% of full power.

The best time to change the setting is near the end of the Quick Defrost cycle.

1. Open the door.
2. Check the food with a long-tined fork; if center area is hard frozen, set additional time. **Remember that standing time is necessary to complete defrosting.**
3. Close the door and touch START to continue the cycle if no additional time is needed.

OR...

Touch in new instructions for additional defrosting time.

Cooking automatically after defrosting

The controls can be set so the microwave oven goes automatically from defrosting to the Cook cycle you have touched in.

1. Put food in the oven and close the door.
2. Touch QUICK DEFROST. The QUICK DEFROST Indicator Light will come on and the Display will show four 0's.
3. Touch Number Pads for the defrosting time you want. The Display will show the numbers you touched **in the order you touched them**. This example shows 2 minutes, 30 seconds.

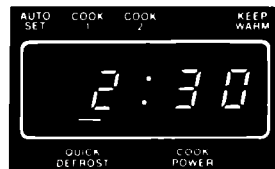
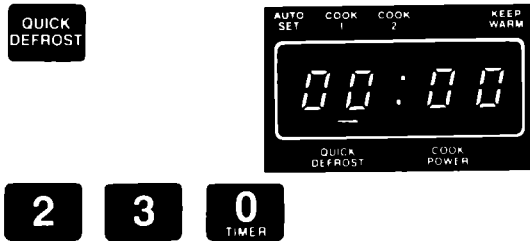

4. Touch COOK 1. The COOK 1 Indicator Light will come on and the Display will show four 0's.

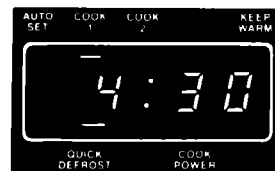
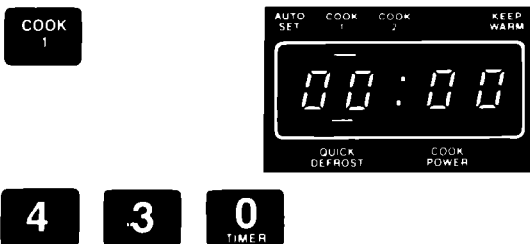

5. Touch Number Pads for the cooking time you want. The Display will show the numbers you touched **in the order you touched them**. This example shows 4 minutes, 30 seconds.



6. Select a Cook Power. To cook at HIGH power, skip to Step 8. To select another Cook Power, touch COOK POWER. The COOK POWER Indicator Light will come on and the Display will show "P-HI". This shows the oven is preprogrammed to cook at full (HIGH) power.



7. Touch a Number Pad for the Cook Power you want. The Display will show what you touched. This example shows you touched Number Pad 6 for 60% of full power.

START

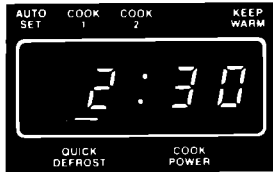

BEEP BEEP

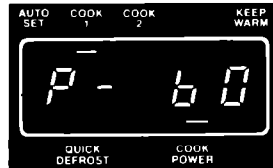

BEEP BEEP BEEP BEEP

8. Touch START. When you touch START, the QUICK DEFROST Indicator Light will stay on. All other Indicator Lights will go off. The Display counts down the time to show how much time is left in the Quick Defrost cycle.

When the defrost time ends, the microwave oven automatically lets the food stand for the **same amount of time used for defrosting**. The QUICK DEFROST Indicator Light stays on and the Display counts down the standing time. **During the countdown the oven will be dark, and the fan will be off.**

When the standing time is over, you will hear 2 beeps and the Cook cycle will start.

The COOK 1 Indicator Light will be on during the Cook cycle. The COOK POWER Indicator Light will also be on **if you are using a Cook Power other than HIGH.**

The Display counts down the time to show how much time is left in the second cycle.

For 2 of every 10 seconds, the Display will show the Cook Power you selected, if you are using a Cook Power other than HIGH.

When the Cook cycle ends, "End" will show on the Display and 4 beeps will sound. (You can stop the beeping by opening the door or by touching CANCEL.) "End" will remain on the Display and a reminder tone will sound every 30 seconds (to remind you that food is left in the oven) until the door is opened or CANCEL is touched. The Display will then show the time of day.

Cooking in more than one cook cycle

For best results, some recipes call for one Cook Power for a certain length of time, and another Cook Power for another length of time. Your oven can be set to change from one to another automatically.

1. Put food in the oven and close the door.
2. Touch COOK 1. The COOK 1 Indicator Light will come on and the Display will show four 0's.

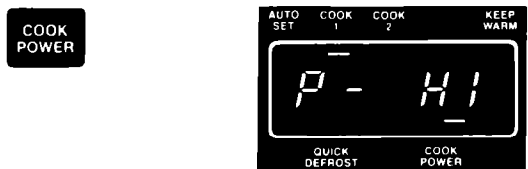
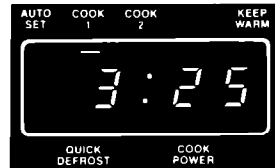
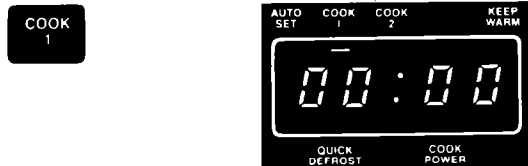

3. Touch Number Pads for the cooking time you want in the first cycle. The Display will show the numbers you touched **in the order you touched them**. This example shows 3 minutes, 25 seconds.

4. Select a Cook Power. To cook at HIGH power, skip to Step 6. To select another Cook Power, touch COOK POWER. The COOK POWER Indicator Light will come on and the Display will show "P-HI". This shows the oven is preprogrammed to cook at full (HIGH) power.



5. Touch a Number Pad for the Cook Power you want in the first cycle. The Display will show what you touched. This example shows you touched Number Pad 6 for 60% of full power.



6. Touch COOK 2. The COOK 2 Indicator Light will come on and the Display will show four 0's.

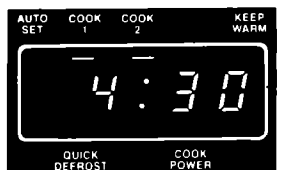

7. Touch Number Pads for the cooking time you want in the second cycle. The Display will show the numbers you touched **in the order you touched them**. This example shows 4 minutes, 30 seconds.

COOK POWER

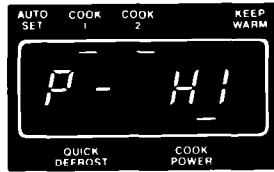

4

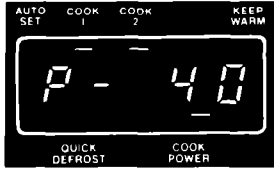

START



BEEP BEEP



BEEP BEEP BEEP BEEP

8. Select a Cook Power. To cook at HIGH power, skip to Step 10. To select another Cook Power, touch COOK POWER. The COOK POWER Indicator Light will come on and the Display will show "P-HI". This shows the oven is preprogrammed to cook at full (HIGH) power.

9. Touch a Number Pad for the Cook Power you want in the second cycle. The Display will show what you touched. This example shows you touched Number Pad 4 for 40% of full power.

10. Touch START. When you touch START, the COOK 1 Indicator Light will stay on while the oven is cooking in the first cycle. The COOK POWER Indicator Light will be on if you are using a Cook Power other than HIGH. All other Indicator Lights will go off.

The Display counts down the cooking time to show how much time is left in the first cycle.

For 2 of every 10 seconds, the Display will show the Cook Power you selected, if you are using a Cook Power other than HIGH.

You will hear 2 beeps at the end of the Cook 1 cycle. You can either open the door to check, stir or turn over the food, etc., or you can let the oven start the next cycle. If you do open the door, touch START after closing the door to restart the oven.

The COOK 2 Indicator Light will be on during the second cycle. The COOK POWER Indicator Light will also be on if you are using a Cook Power other than HIGH.

The Display counts down the time to show how much time is left in the second cycle.

For 2 of every 10 seconds, the Display will show the Cook Power you selected, if you are using a Cook Power other than HIGH.

When the Cook 2 cycle ends, "End" will show on the Display and 4 beeps will sound. (You can stop the beeping by opening the door or by touching CANCEL.) "End" will remain on the Display and a reminder tone will sound every 30 seconds (to remind you that food is left in the oven) until the door is opened or CANCEL is touched. The Display will then show the time of day.

Using Your Microwave Oven Continued

Hints for cooking with more than one cycle

You can program the cooking cycles in any order. However, when the microwave oven is started, it will automatically go through the cycles in the order of the examples described in this book. For example, if you program COOK 1, KEEP WARM and QUICK DEFROST, the microwave oven will automatically follow this sequence: QUICK DEFROST → (STANDING TIME) → COOK 1 → KEEP WARM.

NOTE: The microwave oven will automatically provide standing time between QUICK DEFROST and COOK 1. (See page 17.)

Changing or adding instructions

You can change times, Cook Powers, or add cycles any time before touching START or during oven operation:

1. Touch the Cook cycle you wish to change or add (COOK 1 or 2).
2. Touch numbers for new time, if desired.
3. Touch COOK POWER, if change is desired.
4. Touch number for new Cook Power, or touch COOK POWER again if HIGH is desired.
5. Touch in new cycle and time, if desired.
6. Touch START.

Using PAUSE

For best results, some recipes call for stirring, turning over or rearranging food, or for adding ingredients during cooking. Your microwave oven can be set to pause between COOK 1 and COOK 2, between AUTO SET and a following cycle, between QUICK DEFROST and a following cycle (except COOK 1), or during QUICK DEFROST.

This gives you time to stir (casseroles), turn over (meat) or rearrange (potatoes) food, or to add ingredients. PAUSE is not available between any cycle and KEEP WARM or after QUICK DEFROST.

1. Put food in the oven and close the oven door.
2. Touch in the desired cooking instructions for COOK 1, (page 20).
3. Touch PAUSE. The COOK 1 Indicator Light will be on and the Display will show "PAUS".
4. Touch in the desired cooking instructions for COOK 2, (see page 20).

PAUSE



START



BEEP BEEP



5. Touch START. The Display will show the time you selected for Cook 1.

When Cook 1 is over, 2 beeps will sound and the oven will shut off. The Display will show "PAUS".



The COOK 2 Indicator Light will come on. Open the door, stir, turn over or rearrange the food or add ingredients. Close the door. Touch START to continue with Cook 2.

NOTE: The oven will remain off until you touch START.

Using Your Microwave Oven Continued

**QUICK
DEFROST**



2

3

0
TIMER

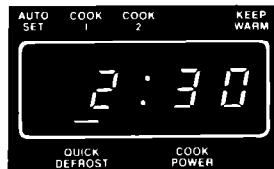

PAUSE



START



**BEEP
BEEP**

Using PAUSE with QUICK DEFROST

Your microwave oven can be set to pause halfway through QUICK DEFROST to allow you to stir, turn over or rearrange the food for more even defrosting.

1. Put frozen food in the oven and close the door.
2. Touch QUICK DEFROST.

3. Touch Number Pads for the defrosting time you want.

4. Touch PAUSE.

5. Touch START.

When half of the QUICK DEFROST time is remaining, you will hear 2 beeps and the oven will shut off.

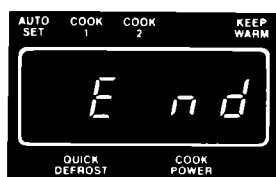
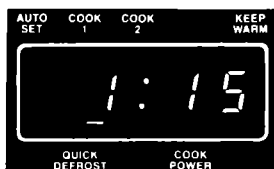

BEEP BEEP BEEP BEEP

6. Open the door. You can stir, turn over or rearrange the food being defrosted, if needed. Close the door.

7. Touch START to continue QUICK DEFROST.

NOTE: The oven will remain off until you touch START.

When the defrost time ends, "End" will show on the Display and 4 beeps will sound. (You can stop the beeping by opening the door or by touching CANCEL.) "End" will remain on the Display and a reminder tone will sound every 30 seconds (to remind you that food is left in the oven) until the door is opened or CANCEL is touched. The Display will then show the time of day.

Adding "PAUSE" between cycles

Pause can be added to any cycle in operation as long as there is another cycle programmed to follow.

1. Touch PAUSE.
2. Touch START.

The microwave oven will stop automatically after the cycle in operation. You will hear 2 beeps. START must be touched to continue with the next cycle.

KEEP
WARM



START



Using KEEP WARM

Hot, cooked foods can be safely kept warm in your microwave oven for up to 99 minutes, 99 seconds (about 1 hour, 40 minutes). KEEP WARM can be used by itself, or it can automatically follow a Cook cycle.

1. Put cooked, hot food in oven and close door.
2. Touch KEEP WARM. The KEEP WARM Indicator Light will come on. The Display will show the time of day.

3. Touch START. The KEEP WARM Indicator Light will stay on. The oven light and the fan will come on. The Display will continue to show the time of day.

- KEEP WARM operates for up to 99 minutes, 99 seconds.
- Opening the oven door cancels KEEP WARM. Close the door and touch KEEP WARM, then START if additional KEEP WARM time is desired.
- Foods cooked covered should be covered during KEEP WARM.
- Pastry items (pies, turnovers, etc.) should be uncovered during KEEP WARM.
- Complete meals kept warm on a dinner plate should be covered during KEEP WARM.
- The use of more than one complete KEEP WARM (about 1 hour, 40 minutes) is not recommended. The quality of some foods will suffer with extended time.

To automatically follow another cycle

- While you are touching in cooking instructions, touch KEEP WARM before touching START.
- OR...**
1. After the oven starts operating, touch KEEP WARM and then START.
 2. When the last cooking cycle is over, you will hear 4 beeps. The KEEP WARM Indicator Light will come on and the time of day will be displayed while the oven continues to run.
 3. KEEP WARM will follow QUICK DEFROST, COOK 1, COOK 2 or AUTO SET.

Using the Minute Timer

The microwave oven controls can be used as a minute timer. Use COOK 1 at "0" Cook Power for timing up to 99 minutes, 99 seconds.

NOTE: The oven will not operate while the Minute Timer is in use.

1. Touch COOK 1. The COOK 1 Indicator Light will come on and the Display will show four 0's.

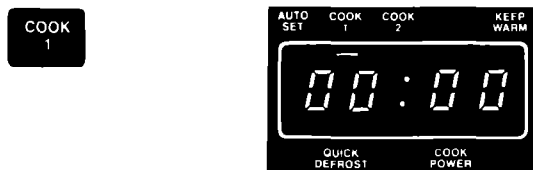

2. Touch Number Pads for the minutes and seconds you want. The Display will show the numbers you touched **in the order you touched them**. This example shows 1 minute, 45 seconds.

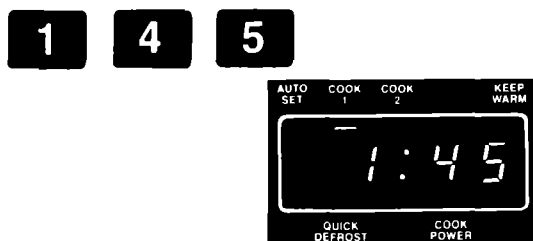

3. Touch COOK POWER. The COOK POWER Indicator Light will come on and the Display will show "P-HI".

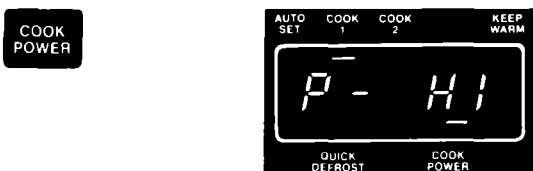

4. Touch the "0" Number Pad. The Display will show "P-0". This tells you that the oven will be operating at 0% power.

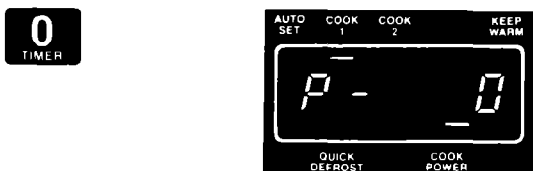

5. Touch START.

NOTE: If you hear the fan start when you touch START, you have not set the oven properly. Touch CANCEL and start over.

The COOK 1 and COOK POWER Indicator Lights will stay on to show you that the timer is running.

The Display counts down to show you how much time is left. During the countdown the oven will be dark and the fan will be off.

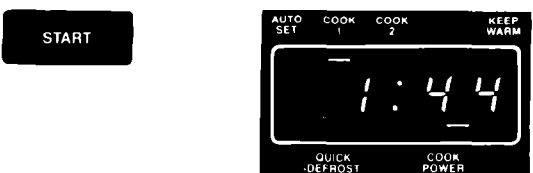

Using Your Microwave Oven Continued

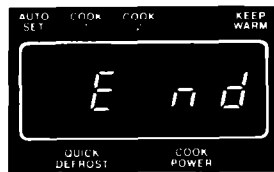

BEEP BEEP BEEP BEEP

When the set time ends, "End" will show on the Display and 4 beeps will sound. (You can stop the beeping by opening the door or by touching CANCEL.) "End" will remain on the Display and a reminder tone will sound every 30 seconds (to remind you that the Minute Timer has ended) until the door is opened or CANCEL is touched. The Display will then show the time of day.

NOTE: Opening the oven door stops the count-down. Close the door and touch START to continue the timing countdown.

Using delayed start

The microwave oven can be set to start automatically at a later time. Use the Cook 1 cycle at "0" Cook Power to delay the start of the Cook 2 cycle for up to 99 minutes, 99 seconds.

- Put in food and close the door. (See WARNING on page 29.)
- Touch COOK 1. The COOK 1 Indicator Light will come on and the Display will show four "0"s.
- Touch Number Pads for the length of delay you want. The Display will show the numbers you touched **in the order you touched them**. This example shows 60 minutes (1 hour).
- Touch COOK POWER. The COOK POWER Indicator Light will come on and the Display will show "P-HI".
- Touch the "0" Number Pad. The Display will show "P-0". This tells you that the oven will be operating at 0% power.
- Touch COOK 2. The COOK 2 Indicator Light will come on and the Display will show four "0"s.
- Touch in the cooking time and Cook Power.

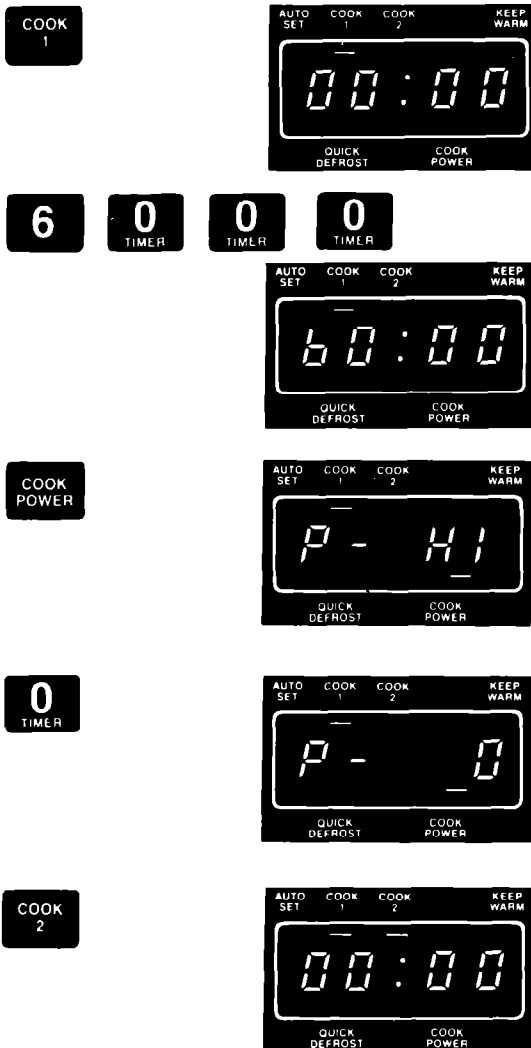



8. Touch START. During the Cook 1 cycle the oven will be off, but the Display will count down the set time. After this time is up, the Cook 2 cycle will begin.

NOTE: If you hear the fan start when you touch START, you have not set the oven properly. Touch the CANCEL Pad and start over. When using Delayed Start, the oven cooks only during the Cook 2 cycle.

Additional information

- You can't touch in more than 99 minutes, 99 seconds of delay in the Cook 1 cycle.
- If you open the door before the oven begins to cook, be sure to retouch START.

⚠ WARNING

To avoid sickness and food waste when using delay start:

- Do not use foods that will spoil while waiting for cooking to start, such as dishes with milk or eggs, cream soups, and cooked meats or fish. Any food that has to wait for cooking to start should be very cold or frozen before it is put in the oven. **MOST UNFROZEN FOODS SHOULD NEVER STAND MORE THAN TWO HOURS BEFORE COOKING STARTS.**
- Do not use foods containing baking powder or yeast when using delay start. They will not rise properly.
- Do not allow food to remain in oven for more than two hours after end of cooking cycle.

Other operating hints

There are a number of things you can do with your microwave oven. Some will be reminders. Others will be mentioned for the first time.

To double check settings while the oven is running:

Touch the Command Pad for the setting you want to check. The instruction programmed for that pad will show on the Display for 5 seconds. Then the Display returns to showing what the oven is doing.

To stop the oven while it is running:

1. Open the door. The oven will stop. To restart the oven, close the door and touch START.
2. Touch CANCEL. All instructions will be erased. You must touch in new instructions.
3. If you touch two instructions into the same cycle, the second set of instructions will cancel the first.

Installation Instructions

Before you begin, carefully read the following instructions.

Installing your microwave oven

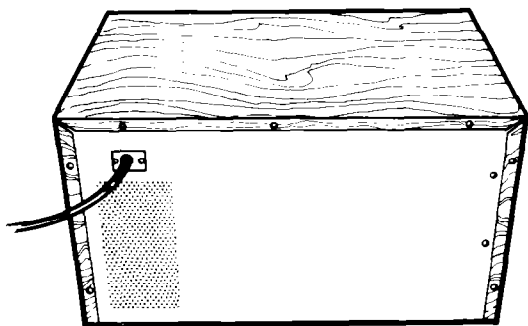
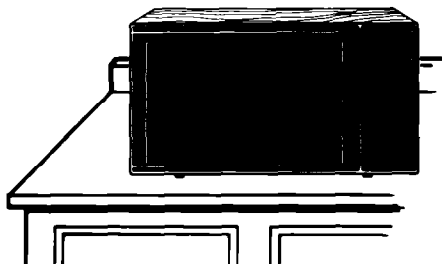
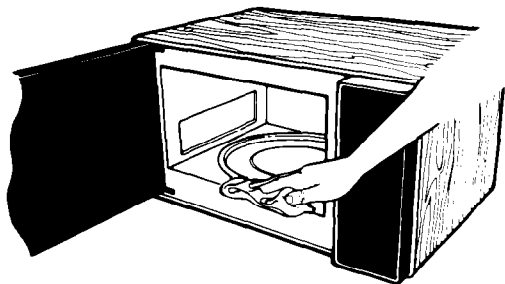

1. Empty the microwave oven and clean inside it with a soft, damp cloth. Check for damage such as misaligned door, damage around the door or dents inside the oven or on the exterior. If there is any damage, please do not operate the unit until it has been checked by an authorized WhirlpoolSM service technician and any repairs made.
2. Put the oven on a cart, counter, table or shelf that is strong enough to hold the oven and the food and utensils you put in it. **(The control side of the unit is the heavy side. Use care when handling.)** The weight of the oven is approximately 31 lbs. (14kg).
3. **Do not block the rear air intake opening.** Blocking the air intake opening can cause damage to the oven and poor cooking results. Make sure the microwave oven legs are in place to ensure proper air flow.

CAUTION

Do not install the oven next to a conventional surface unit or in any area where excessive heat and steam are generated. This could damage the outside of the cabinet.

4. Electrical requirements

Observe all governing codes and ordinances. A 120 Volt, 60 Hz, AC only, 15 or 20 amp fused electrical supply is required. (Time-delay fuse is

recommended.) It is recommended that a separate circuit serving only this appliance be provided.

5. GROUNDING INSTRUCTIONS

⚠ WARNING

Electrical Shock Hazard

Improper use of the grounding plug can result in a risk of electrical shock. DO NOT, UNDER ANY CIRCUMSTANCES, REMOVE THE POWER SUPPLY CORD GROUNDING PRONG.

6. For your personal safety, this appliance must be grounded. In the event of an electrical short circuit, grounding reduces the risk of electrical shock by providing an escape wire for the electric current. This appliance is equipped with a polarized 3-prong grounding plug. It must be plugged into a correctly polarized mating 3-prong grounding type wall receptacle, properly installed and grounded in accordance with the National Electrical Code and local codes and ordinances. If a mating wall receptacle is not available or if you are not sure if the wall receptacle is properly grounded and polarized, have it checked by a qualified electrician.

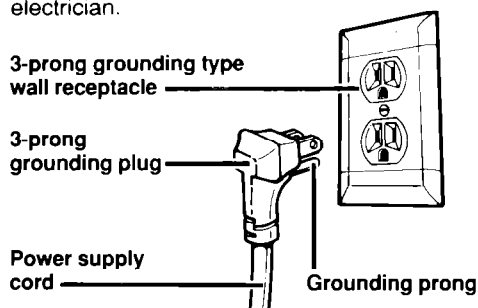

It is the personal responsibility and obligation of the customer to have a properly grounded and correctly polarized 3-prong wall receptacle installed by a qualified electrician.

Consult a qualified electrician if the grounding instructions are not completely understood, or if doubt exists as to whether the appliance is properly grounded.

It is not recommended to use an extension cord with your microwave oven, but if you find it necessary to do so temporarily (until a properly grounded and polarized 3-prong receptacle is installed), use only a heavy duty UL listed 3-wire grounding type extension cord containing three 16-gauge (minimum) copper wires. It must not be longer than 10 feet (cords longer than 10 feet may affect the cooking performance of your microwave oven). The plug on the extension cord must fit into a 3-prong grounding type wall receptacle (as shown on this page) and the receptacle end of the extension cord must accept the 3-prong grounding plug of the microwave oven.



7. To test the oven, plug it into the proper electrical outlet. Put about one cup (250mL) of cold water in a glass container in the oven.

Close the door. Make sure it latches. Follow the directions on page 12 to set the oven to COOK for 2 minutes. When the time is up, the water should be heated.

8. **This microwave oven is designed for use in the household only and must not be used for commercial purposes.**

Do not remove the door, control panel or cabinet at any time. The unit is equipped with high voltage and should not be serviced unless by an authorized WhirlpoolSM service technician.

- SAVE THESE INSTRUCTIONS -

Caring For Your Microwave Oven

Cleaning the microwave oven

Wipe often with warm sudsy water and a soft cloth or sponge. The glass turntable may be removed for cleaning. Wash by hand in mild detergent or in a dishwasher. **Do not** operate the microwave oven when turntable is removed for cleaning.

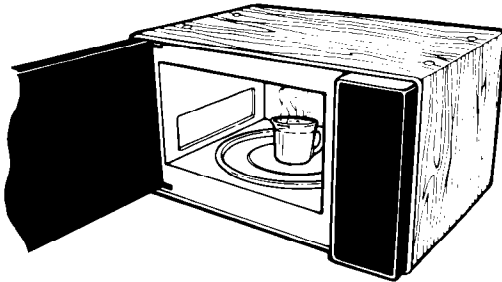
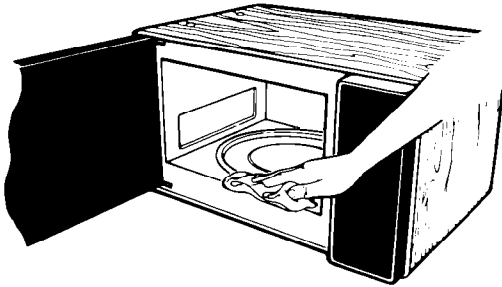

For stubborn soil, boil a cup of water in the oven for 2 or 3 minutes. Steam will soften the soil.

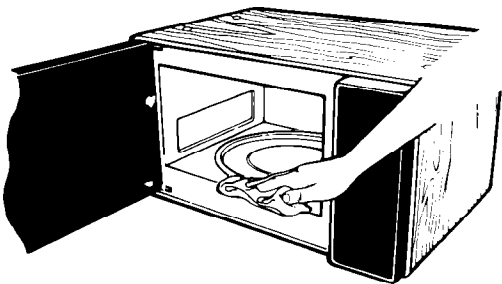

Be sure to keep the areas clean where the door and oven frame touch when closed. Use only mild, non-abrasive soaps or detergents applied with a sponge or soft cloth when cleaning surfaces. Rinse well.

⚠ CAUTION

Abrasive cleansers, steel wool pads, gritty wash cloths, etc., can damage the control panel, and the interior and exterior oven surfaces. Use a soft cloth or a sponge with a mild detergent or spray glass cleaner.

How Your Microwave Oven Works

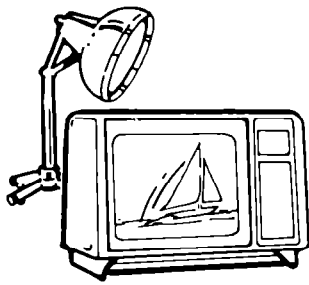

Microwave ovens are safe. Microwave energy is not hot. It causes food to make its own heat, and it's this heat that cooks the food.

Microwaves are like TV waves or light waves. You can't see them, but you can see what they do.

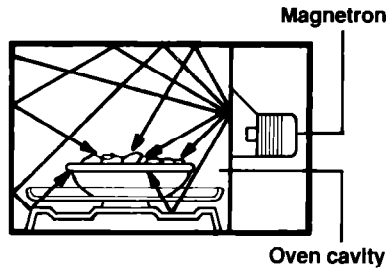

The glass turntable of your microwave oven lets microwaves through. Then they bounce off a metal floor, back through the glass turntable and are absorbed by the food.

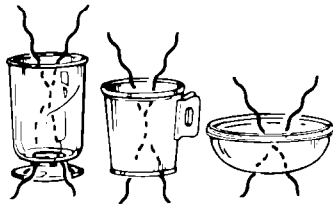

Microwaves pass through glass, paper and most plastics without heating them so food absorbs the energy. Microwaves bounce off metal pans so food does not absorb the energy.

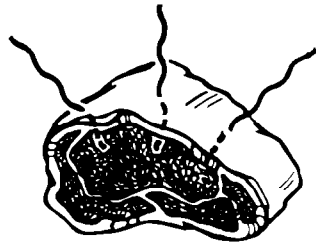

Microwaves may not reach the center of a roast. The heat around the outside is what cooks the roast all the way through. This is one of the reasons for letting some foods (roasts, baked potatoes) stand for a while after cooking, or for stirring some foods during the cooking time.

The microwaves disturb water molecules in the food. As the molecules bounce around bumping into each other, heat is made, like rubbing your hands together. This is the heat that does the cooking.

Operating Safety Precautions

⚠️ WARNING

To reduce the risk of fire, electrical shock, injury to persons, or damage when using the microwave oven, follow the precautions on page 34-37.



Never cook or reheat a whole egg. Steam build-up in whole eggs may cause them to burst and burn you, and possibly damage the oven. Slice hard boiled eggs before heating. In rare instances, poached eggs have been known to explode. Cover poached eggs and allow a standing time of one minute before cutting into them.



Liquids heated in certain containers (especially cylindrical-shaped containers) may become overheated. The liquid may splash out with a loud noise during or after heating or when adding ingredients (coffee, etc.) resulting in harm to the oven and possible personal injury. For best results stir any liquid several times before heating or reheating.

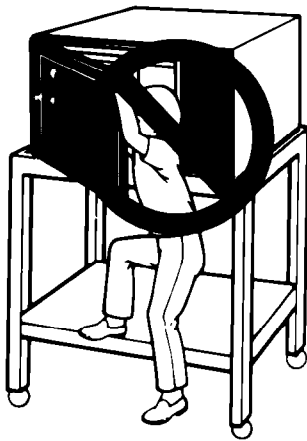

Never lean on the door or allow a child to swing on it when the door is open. Injury could result.

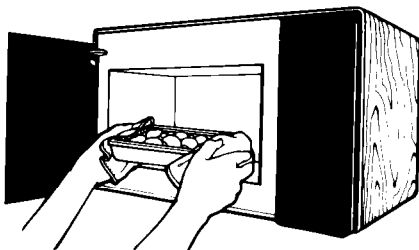

Use hot pads. Microwave energy does not heat containers, but the hot food does.

Do not heat, store or use flammable materials in or near the oven. The fumes can create a fire hazard or explosion.

Do not do canning of foods in the oven. Closed glass jars may explode resulting in damage to the oven or possible personal injury.

Do not use the oven to sterilize objects (baby bottles, etc.). It is difficult to maintain the high temperature required for safe sterilization.

Do not deep fry in the oven. Microwavable utensils are not suitable and it is difficult to maintain appropriate deep frying temperatures.

Do not use the oven for storage. Do not leave paper products, books or cooking utensils in the oven when not in use. Fire may result if someone accidentally starts the oven.

Do not let food or containers touch the top or sides of the oven.

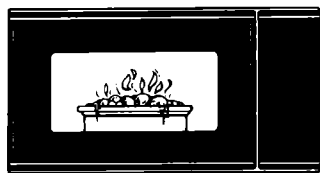
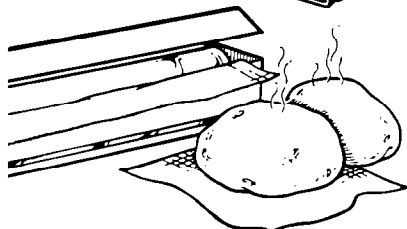
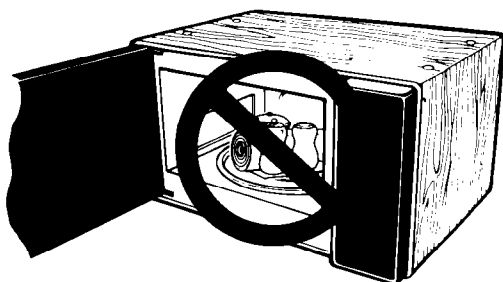

Do not overcook potatoes. Fire could result. At the end of the recommended cooking time they should be slightly firm.

Wrap in foil and set aside for 5 minutes. They will finish cooking while standing.

If a fire should start in the oven cavity:

- do not open oven door
- turn oven off
- unplug the oven or turn off the power at the main power supply.

Do not place anything within five inches of the left side of the oven. Damage to the oven may result.

Air vents

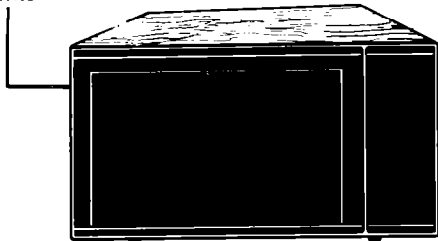

Operating Safety Precautions Continued

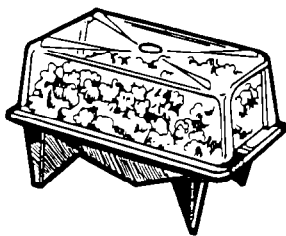

Do not pop popcorn, except in a microwave approved popcorn popper or commercial package designed especially for microwave ovens. Follow directions supplied with the popper.

Never try to pop popcorn in a paper bag. Overcooking may result in smoke and fire.

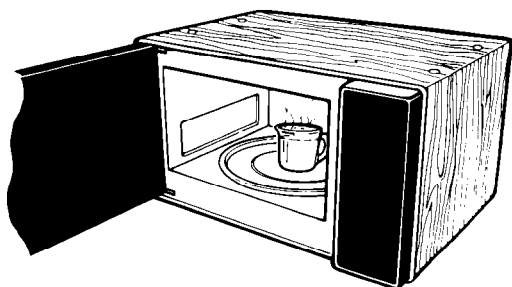

Starting a microwave oven when it's empty is not recommended.

If you experiment, put a container of water in the oven.

It is normal for the inside of the oven door to look wavy after the oven has been running for a while.

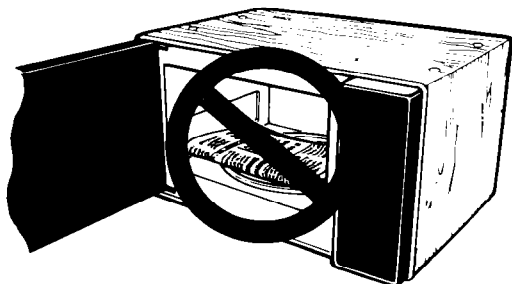

Do not use newspaper or other printed paper in the oven. Fire could result.

Do not dry flowers, fruit, herbs, wood, paper, gourds or clothes in the oven. Fire could result.

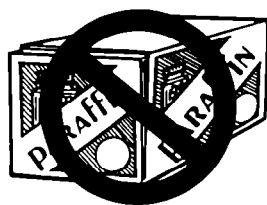

Do not try to melt paraffin wax in the oven. You may be burned because paraffin wax will not melt.

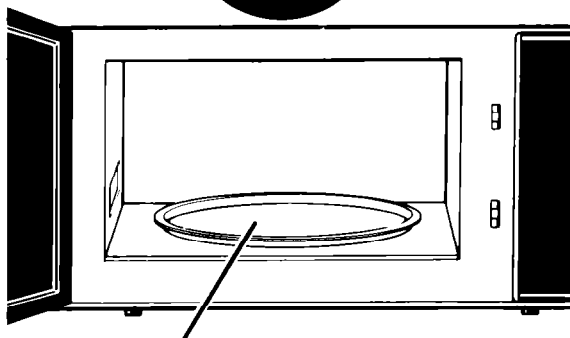

Glass turntable

Glass turntable

Do not operate the microwave oven unless the glass turntable is securely in place and can rotate freely. The turntable can turn in either direction.

Carefully place cookware on glass turntable to avoid possible breakage.

Handle glass turntable with care when removing from oven to avoid possible breakage.

When a browning dish is used, the browning dish bottom must be at least 3/16 inch above the glass turntable.

General information

If your electric power line or outlet voltage is less than the normal 120 volts, cooking times may be longer.

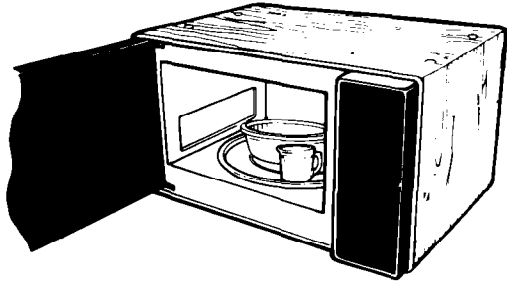
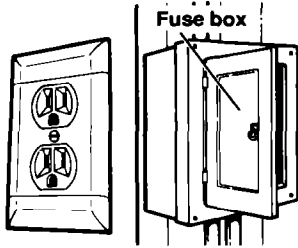

To test a dish for safe use, put it into the oven with a cup of water **beside it**. Cook on HIGH Cook Power for one minute. **If the dish gets hot and water stays cool, do not use it.**

If You Need Service Or Assistance...

We suggest you follow these steps:

1. Before calling for assistance...

Performance problems often result from little things you can find and fix without tools of any kind.

If nothing operates:

- Is the power supply cord plugged into a live circuit with the proper voltage? (See Installation Instructions.)
- Have you checked your home's main fuses or circuit breaker box?
- Have you checked the electric company for a power failure?

If the microwave oven will not run:

- Is the oven being used as a timer?
- Is the door firmly closed and latched?
- Did you touch START?
- Did you follow the directions exactly?

If the microwave cooking times seem too long:

- Is the electric supply to your home or wall outlets low or lower than normal? Your electric company can tell you if the line voltage is low. Your electrician or service technician can tell you if the outlet voltage is low.
- Is the Cook Power at the recommended setting?
- Are you allowing for more time when cooking more food at one time?

If the Display shows a time counting down but the oven is not cooking:

- Is the oven door closed completely?
- Have you set the controls as a minute timer?
- Is the oven in standing time between QUICK DEFROST and COOK 1? (See page 17.)

If you do not hear the programming tone:

- Is the command correct?
- Has the tone been cancelled? (See page 10.)

If the fan seems to be running slower than usual:

- Has the oven been stored in a cold area? The fan will run slower until the oven warms up to normal room temperature.

If there has been a power interruption, the Display will show 88:88. Reset the clock. (See page 11.)

**2. If you need assistance*...
Call Whirlpool COOL-LINE® service assistance
telephone number. Dial free from anywhere in
the U.S.:**

1-800-253-1301

and talk with one of our trained consultants. The consultant can instruct you in how to obtain satisfactory operation from your appliance, or if service is necessary, recommend a qualified service company in your area.

If you prefer, write to:

Mr. Donald Skinner
Director of Consumer Relations
Whirlpool Corporation
2000 M-63
Benton Harbor, MI 49022

Please include a daytime phone number in your correspondence.

3. If you need service*...



Whirlpool has a nationwide network of authorized WhirlpoolSM service companies. Whirlpool service technicians are trained to fulfill the

product warranty and provide after-warranty service, anywhere in the United States. To locate the authorized Whirlpool service company in your area, call our COOL-LINE® service assistance telephone number (see Step 2) or look in your telephone directory Yellow Pages under:

APPLIANCES-HOUSEHOLD-
MAJOR-SERVICE & REPAIR

ELECTRICAL APPLIANCES-
MAJOR-REPAIRING & PARTS

OR

WASHING MACHINES, DRYERS
& IRONERS-SERVICING

WHIRLPOOL APPLIANCES
AUTHORIZED WHIRLPOOL SERVICE

SERVICE COMPANIES

XYZ SERVICE CO.
123 MAPLE . . . 999-9999

**4. If you are not satisfied with how the
problem was solved*...**

- Contact the Major Appliance Consumer Action Panel (MACAP). MACAP is a group of independent consumer experts that voices consumer views at the highest levels of the major appliance industry.
- Contact MACAP only when the dealer, authorized servicer or Whirlpool have failed to resolve your problem.
Major Appliance Consumer
Action Panel
20 North Wacker Drive
Chicago, IL 60606
- MACAP will in turn inform us of your action.

* When requesting assistance, please provide: model number, serial number, date of purchase, and a complete description of the problem. This information is needed in order to better respond to your request.

Cooking Guide

INTRODUCTION

1. How Your Microwave Oven Works

Microwaves are a form of energy similar to radio and television waves. Your microwave oven is constructed in such a way as to take advantage of microwave energy. Electricity is converted into microwave energy by the magnetron tube, and microwaves are then sent into the cooking area through openings at the top of the oven. Microwaves reflect off the metal walls of the oven. Since microwaves do not penetrate metal, cooking utensils made of metal are not used for cooking in the microwave. They can neither reflect nor absorb the microwaves. The microwaves can however be transmitted through glass, paper, wicker and microwavable cooking dishes. Microwaves do not heat the cookware, though vessels will eventually feel hot from the heat generated by the food. Microwaves are attracted to the moisture in foods and cause the water molecules to vibrate, 2,450 million times per second. This is called absorption. As the water molecules vibrate they rub against each other, producing friction. This friction, in turn, causes the food to get hot. If you have trouble imagining how this is possible, just think how hot your hands would get if you rubbed your palms together 2,450 million times per second!

A very safe appliance: Your microwave oven is one of the safest of all home appliances. When the door is opened, the oven automatically stops producing microwaves. By the time microwave energy has been converted into heat in the process of making food hot, the microwaves have completely dissipated.

2. Getting the Best Results From Your Microwave Oven

Keeping an eye on things: The recipes in this book have been formulated with great care, but your success in preparing them depends on how much attention you pay to the food as it cooks. Your microwave oven is equipped with a light that turns on automatically when the oven is in operation. You can see inside the oven and check the progress of your food. Directions given in recipes to "stir", "rotate", etc., should be thought of as the minimum steps recommended for even cooking and speed in the microwave.

Factors affecting cooking time: The cooking times given in the recipes in this book are approximate. Many factors affect cooking times. The temperature of ingredients used in a recipe makes a big difference in the cooking time. For example a cake made with cold butter, milk, and eggs will take considerably longer to bake than one made with ingredients that are at room temperature.

Range of cooking times: Most of the recipes in this book give a range of cooking times. In general, you will find that the food remains undercooked at the lower end of the time range. You may sometimes want to cook your food beyond the maximum time given. Personal preferences vary, as do the cooking speeds of different ovens under different conditions. While undercooked food may always be cooked a bit more, overcooked food can be ruined.

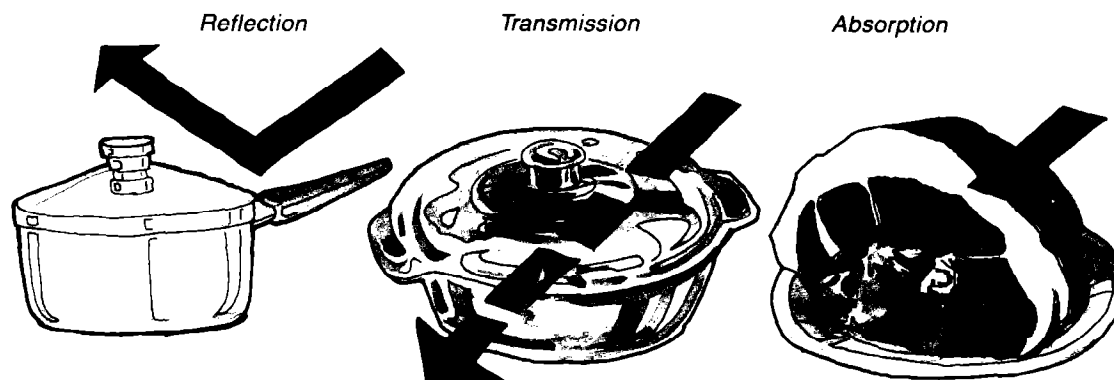

Some of the recipes, particularly those for breads, cakes, and meats suggest that food be removed from the oven when it is still slightly undercooked. This is not a mistake. When allowed to stand, the food will continue to cook outside the oven, as the heat trapped within the outer portions of the food gradually travels inward. If the food is left in the oven until it is cooked all the way through, the outer portions will become overcooked. As you gain experience in using your microwave oven, you will become increasingly skillful in estimating both cooking and standing times for various foods.

3. How Characteristics of Foods Affect Microwave Cooking

Quantity: The greater the volume of food, the longer it takes to cook it. In general, cooking time is increased by almost 50 percent when doubling a recipe. Time is reduced by approximately 40 percent when cutting a recipe in half.

Density: Light, porous food such as cakes and breads cook more quickly than heavy, dense food such as roasts, potatoes, and casseroles.

Height: Whether conventional or microwave cooking methods are used, areas of food close to the energy source may need to be turned over or shielded for even cooking.

Shape and Size: For more even cooking results, choose food pieces that are similar in size and shape. Arrange small, thin pieces toward the center of the dish and thicker pieces toward the outside of the dish.

Sugar, Fat, and Salt: Food with high sugar, fat, and salt content cooks faster than food low in these elements.

4. Special Techniques in Microwave Cooking

Browning: Meat and poultry with high fat content that are cooked 10 to 15 minutes or longer will brown lightly. Food that is cooked for a shorter period of time may be brushed with a browning agent to achieve an appealing color. The most commonly used browning sauces are Worcestershire sauce, soy sauce and barbecue sauce.

Covering: A cover traps heat and steam causing the food to cook more quickly. You may either use a lid or plastic wrap with a corner folded back to vent the excess steam. Recipes calling for covered microwavable casseroles use the glass casserole covers to help retain the steam; however, the covers can become hot during cooking so handle carefully. Waxed paper effectively prevents food from spattering in the oven and helps food retain some heat. Sandwiches and many other foods can be wrapped in paper towels to prevent them from drying out.



Spacing: Individual foods such as baked potatoes, cupcakes, and hors d'oeuvres will cook more evenly if placed in the oven at least an inch apart, preferably in a circular pattern.

Stirring: Stirring is an important microwaving technique. Microwaved foods are stirred in order to blend flavors and redistribute heat. Always stir from the outside toward the inside, since the outside of the food heats first.

Turning Over: Larger sized food such as roasts and whole poultry should be turned over so that the top and bottom will cook evenly. It is also a good idea to turn over chicken pieces and chops.

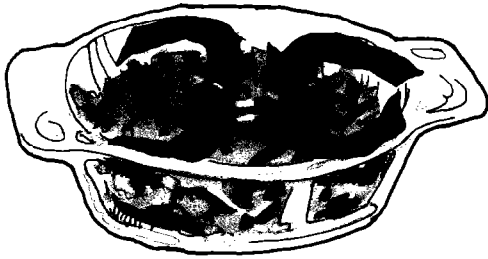

Piercing: To prevent bursting, food enclosed in a shell, skin or membrane must be pierced prior to cooking. Such foods include both the yolks and whites of eggs, hot dogs, clams, oysters, and many whole vegetables, such as potatoes and squash.

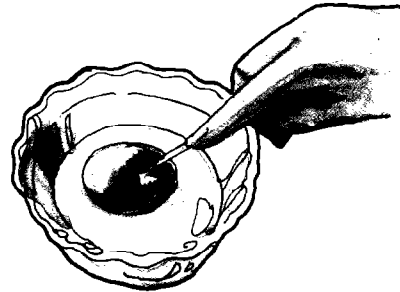

Arrangement: Since dense foods cook more slowly in the microwave, it makes sense to place thicker portions of meat, poultry, fish and vegetables to the outer edge of the baking dish. This way, thicker portions will receive the most microwave energy and the food will cook evenly. Also, arrange food in a single layer rather than stacking to permit more even cooking.

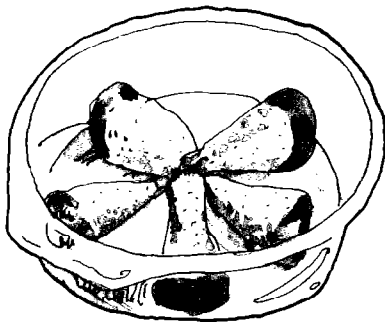

Testing for Doneness: Because foods cook so quickly in a microwave oven, it is necessary to test for doneness frequently. Check recipes for specific visual doneness information.

Standing Time: Food is often allowed to stand for 2 to 10 minutes after being removed from the microwave oven. Usually the food is covered during standing time to retain heat. Most foods are removed from the oven while still slightly undercooked, and finish cooking during standing time. The internal temperature of food will rise about 10° during standing time.

Shielding: Strips of aluminum foil, which block microwaves, are sometimes placed over the corners or edges of square and rectangular shaped pans to prevent those portions from overcooking. Irregular food shapes such as poultry legs and wings tips can be shielded with foil to keep them from overcooking. Keep foil at least one inch from the oven walls.

5. Microwave-Safe Utensils

Never use metal or metal-trimmed utensils in your microwave oven. Microwaves cannot penetrate metal. They will bounce off any metal object in the oven and cause "arcing", which resembles lightning. Most heat-resistant, nonmetallic cooking utensils are safe for use in your microwave oven. However, some may contain materials that render them unsuitable for microwave cooking. If you have any doubts about a particular utensil, there's a simple way to find out if it can be used in your microwave oven.

Testing Utensils for Microwave Use: Place the utensil in question next to a glass measure filled with water in the microwave oven. Cook 1 minute at Power Level 10. If the water is warm and the utensil remains cool, the utensil is microwavable. However, if the utensil becomes warm, microwaves are being absorbed by the utensil and it should not be used in the microwave oven.

You probably have many items on hand in your kitchen right now that can be used as cooking equipment in your microwave oven. Read through the following checklist.

1. Dinner Plates: Many kinds of tableware are microwavable. This would include most brands of oven-tempered glass cookware. Do not, however, use delicate tumblers, wine glasses, etc. in the oven, as they may possibly shatter.

2. Glassware: Some glassware that is heat-resistant is microwavable. This would include all brands of oven-tempered glass cookware. Do not, however, use delicate tumblers, wine glasses, etc. in the oven, as they may possibly shatter.

3. Paper: Paper plates and containers without wax coatings are convenient and safe to use in your microwave oven for short cooking times. Paper towels are also very useful for absorbing moisture and grease. In general, use white paper, as some dyes may separate.

4. Plastic Storage Containers: These can be used to hold foods that are to be quickly reheated. However, they should not be used to heat foods that will need considerable time in the oven, as hot foods will eventually warp or melt the containers.

5. Cooking Bags: Cooking bags are microwavable. Make sure to make a slit in the bag so that steam can escape. Substitute string or microwavable closure for metal twist ties.

6. Plastic Microwave Cookware: A variety of cookware is available. Certain specialty items such as plastic ring molds, muffin pans, etc. are convenient. Check the manufacturer's instructions.

7. Pottery, Stoneware, and Ceramic: Containers made of these materials are usually fine for use in your microwave oven. They should be checked by using the dish test.

8. Wicker, Straw, Wood: All of these materials are safe for brief use in your microwave oven. Remove any metal fittings.

9. Metal Utensils: Metal utensils and utensils with metal straps, clips, or screws should not be placed in your microwave oven while the oven is in operation. Use wooden skewers, which are available at most cookware shops.

10. Browning Skillets: Browning skillets or grills are useful to provide extra surface browning of meats such as steaks and hamburgers. They heat to a very high temperature and should be handled with great care. Follow the manufacturer's guidelines for directions and proper use.

Do not use these utensils

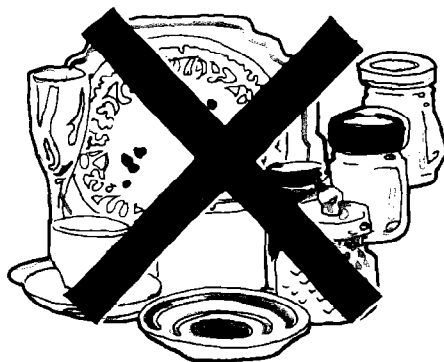

6. Some Microwaving Tips

Boiling Water: Place 1 cup of water in a 2-cup glass measure and cook uncovered 2½ to 3½ minutes at Power Level 10, or until boiling.

Instant Coffee: Place 6 ounces of water in a microwavable cup or mug. Cook uncovered 2 to 2½ minutes at Power Level 10, or until hot. Stir in coffee crystals.

Hot Cocoa: Place 1 or 2 teaspoons each of cocoa powder and sugar in an 8-ounce mug. Gradually add 6 ounces of milk stirring to blend. Cook uncovered 2 to 3 minutes at Power Level 8, or until hot, stirring once.

NOTE: For safe heating of liquids in a microwave oven, see "Operating Safety Precautions" on page 34.

Heating Syrup or Honey: Place in a glass pitcher and cook uncovered at Power Level 10 until warm. Stir once. One cup syrup or honey will take 2 to 3 minutes.

Melting Butter or Margarine: Place butter or margarine in a custard cup or glass measuring cup. Cook uncovered at Power Level 10 until melted.

Softening Butter, Margarine or Cream Cheese: Unwrap and place on a serving plate. Cook uncovered at Power Level 1 checking at 20 second intervals.

Melting Chocolate Squares and Chocolate Pieces: Place in a custard cup or glass bowl and cook uncovered at Power Level 7. One square of unsweetened chocolate or 1 cup of chocolate pieces will take 3 to 4 minutes. Two squares of unsweetened chocolate or 2 cups of chocolate pieces will take 4 to 6 minutes. Stir until smooth.

Melting Caramels: Combine one 14-ounce package of caramels and 2 tablespoons of water in a 4-cup glass measuring cup. Cook uncovered 3 to 4 minutes at Power Level 7, or until melted, stirring every minute.

Toasting Almonds: Place sliced or slivered almonds in a shallow baking dish and add 1 teaspoon of butter or margarine per ½ cup of nuts. Cook uncovered 3 to 4 minutes at Power Level 10, or until light brown, stirring every minute.

Toasting Coconut: Place unsweetened, flaked or grated coconut in a 9-inch glass pie plate. Cook uncovered 3 to 4 minutes at Power Level 7, or until light brown. Stir every minute.

Freshening Up Stale Chips and Pretzels: Place chips or pretzels in a napkin-lined wicker basket. Cook uncovered about 30 seconds per cup at Power Level 10, or until snacks feel warm. Let stand a few minutes to cool before serving.

Warming Bread and Rolls: Wrap in a napkin or place in a napkin lined wicker basket. Cook uncovered 30 seconds to 1 minute at Power Level 8, or until bread or rolls feel warm.

Cooking Bacon: Place bacon slices on a double thickness of paper towel on a paper plate and cover with a paper towel. Cook uncovered 1 to 1½ minutes per slice at Power Level 10, or until crisp. If you wish to save the drippings, cook bacon on a rack placed inside a microwavable baking dish.

7. Microwave Power Levels

Your microwave oven is equipped with ten power levels (11 levels including 0) to give you maximum flexibility and control over cooking. When your cooking program is completed, a beep automatically sounds. The table below will give you some idea of which foods are prepared at each of the various power levels.

MICROWAVE POWER LEVEL CHART

Power Level	Use
10	<ul style="list-style-type: none"> • Boil water. • Brown ground beef. • Make candy. • Cook poultry pieces, fish, vegetables. • Cook tender cuts of meat.
9 (Saute)	<ul style="list-style-type: none"> • Reheat rice, pasta & vegetables.
8 (Reheat)	<ul style="list-style-type: none"> • Reheat prepared foods quickly. • Reheat sandwiches.
7 (Medium High)	<ul style="list-style-type: none"> • Cook egg, milk and cheese dishes. • Cook cakes, breads. • Melt chocolate.
6 (Medium)	<ul style="list-style-type: none"> • Cook veal. • Cook whole fish. • Cook puddings and custards
5 (Medium Low)	<ul style="list-style-type: none"> • Cook ham, whole poultry, lamb. • Cook rib roast, sirloin tip.
4 (Defrost)	<ul style="list-style-type: none"> • Thaw meat, poultry and seafood.
3 (Low)	<ul style="list-style-type: none"> • Cook less tender cuts of meat. • Cook pork chops, roast.
2 (Simmer)	<ul style="list-style-type: none"> • Take chill out of fruit. • Clarify butter.
1 (Warm)	<ul style="list-style-type: none"> • Keep casseroles and main dishes warm. • Soften butter and cream cheese.
0	<ul style="list-style-type: none"> • Standing time. • Independent timer.

MEAT

Now with the help of your microwave, you can serve twice the meal in half the time. Best of all, you don't have to remember to take the meat out of the freezer in the morning for an evening meal. Defrosting techniques and fast cooking eliminate all these meal-planning roadblocks.

Cooking Meat: Tips & Techniques

- Defrost meat completely before cooking.
- Trim off excess fat.
- Place meat fat side down on microwavable roast rack.
- Turn over halfway through cooking to ensure even cooking.
- Arrange meat so thicker portions are toward outside of dish.
- Drain juices as they accumulate to minimize spattering and avoid undercooking bottom of meat.
- Shield thin or bony portions with strips of foil to prevent overcooking. Keep foil at least one inch from oven walls, and do not cover more than one-third of the meat at any one time.
- Cover meat with waxed paper to prevent spattering.
- Let meat stand covered with foil 10 to 15 minutes after removing from microwave. Internal temperature of meat may rise 5°F to 15°F during standing time.
- Use oven cooking bags for less tender cuts of meat.

MEAT COOKING TABLE

Meat	Power Level	Cooking Time	Special Instructions
BEEF Corned beef (3 lbs.)	(Cook 1), HIGH then (Cook 2), 3	15 minutes then 25-30 minutes per pound	Place corned beef in 3-quart microwavable casserole. Pour 1 cup water and desired seasonings over corned beef. Cook covered. Turn over beef during cooking. Shield thinner ends with foil. Cook until fork-tender. Let stand covered 15 minutes. Thinly slice beef diagonally across grain.
Cubes for stew (2 lbs., inch cubes)	(Cook 1), HIGH then (Cook 2), 3	10 minutes then 27-32 minutes per pound	Place cubes in 2½-quart microwavable casserole. Pour 1 cup water or broth over cubes. Cook covered. Stir cubes halfway through cooking. Cook until fork-tender. Let stand covered 10 minutes. Note: For faster cooking and slightly less tenderness, beef cubes for stew may be cooked at PL 10 for 10 minutes, then at PL 3 for 35 minutes per pound.
Ground beef (1 lb.)	HIGH	4-5 minutes	Crumble beef and place in microwavable sieve or colander. Place sieve in bowl to collect drippings. Cover with waxed paper. Stir after 2½ minutes to break meat apart. After cooking let stand covered 2 minutes. If meat is still pink, cover and cook 1 more minute.
Hamburgers, Fresh or defrosted frozen (4 oz, each) 1 patty 2 patties 4 patties	HIGH	¾-1¼ minutes 1¼-2 minutes 2½-3½ minutes	Form patties with depression in center of each. Place on microwavable roast rack. Brush with browning agent, if desired. Cover with waxed paper. Turn over halfway through cooking. Let stand covered 1 minute.
Pot roast (3-4 lbs.)	(Cook 1), HIGH then (Cook 2), 3	15 minutes then 30-35 minutes per pound	Pierce roast deeply on both sides in several places. Place roast in large cooking bag; place in microwavable dish. Add desired seasonings and 1 cup liquid over roast. Close bag loosely with microwavable closure or string. Carefully turn over meat after 45 minutes. Continue cooking until fork-tender. Let stand covered 10 minutes.

MEAT COOKING TABLE (continued)

Meat	Power Level	Cooking Time	Special Instructions
Rib roast, rolled (3-4 lbs.)	5	10-11 minutes per pound RARE (135°F) 11-13 minutes per pound MEDIUM (155°F) 12-14 minutes per pound WELL (165°F)	Place roast fat side down on microwavable roast rack. Add desired seasonings and cover with waxed paper. Turn over meat halfway through cooking and shield if necessary. Let stand covered with foil 15 minutes. (Temperature may rise about 10°F).
Rump roast, rolled (3-4 lbs.)	3	16-18 minutes per pound RARE (135°F) 18-20 minutes per pound MEDIUM (155°F)	Place roast fat side down on microwavable roast rack. Add desired seasonings and cover with waxed paper. Turn over meat halfway through cooking and shield if necessary. Let stand covered with foil 15 minutes. Remove roast from microwave when desired temperature is reached. (Temperature may rise about 10°F).
Sirloin tip roast (3-4 lbs.)	5	9-11 minutes per pound RARE (135°F) 11-13 minutes per pound MEDIUM (155°F)	Place roast fat side down on microwavable roast rack. Add desired seasonings and cover with waxed paper. Turn over meat halfway through cooking and shield if necessary. Remove roast from microwave when desired temperature is reached. Let stand covered with foil 15 minutes. (Temperature may rise about 10°F).
Veal cutlets, (about 1 lb.) 4 pieces	6	7-8 minutes per pound	Place cutlets in bottom of oiled microwavable baking dish. Add desired seasonings and cover with waxed paper. Turn over and rearrange cutlets halfway through cooking. Let stand covered 2 minutes. Drain on paper towel.
LAMB Lamb roast, rolled, boneless (3-4 lbs.)	5	12-13 minutes per pound RARE (135°F) 13-14 minutes per pound MEDIUM (145°F) 15-16 minutes per pound WELL (155°F)	Place roast fat side up on microwavable roast rack. Brush lamb with marinade or desired seasonings such as rosemary, thyme or marjoram. Cover with waxed paper. Turn over roast after 15 minutes, and again after 30 minutes. Shield if necessary. Remove roast from microwave when desired temperature is reached. Let stand covered with foil 15 minutes. (Temperature may rise about 10°F).
Lamb stew cubes (2 lbs.)	(Cook 1), HIGH then (Cook 2), 3	10 minutes 30 minutes per pound	Place cubes in 2-quart microwavable casserole. Add desired seasonings such as rosemary, thyme and marjoram and 1 cup water. Cook covered. Stir cubes twice during cooking. Cook until fork-tender. Let stand covered 15 minutes. NOTE: For faster cooking and slightly less tenderness, lamb cubes for stew may be cooked at PL 10 for 10 minutes, then at PL 3 for 35 minutes per pound.

MEAT COOKING TABLE (continued)

Meat	Power Level	Cooking Time	Special Instructions
PORK Bacon slices 2 slices 4 slices 6 slices	HIGH	1½-2 minutes 2½-3½ minutes 4-5 minutes	Place bacon slices on microwavable roast rack. Cover with paper towels. After cooking let stand 1 minute.
Canadian bacon 2 slices 4 slices 6 slices	HIGH	30-45 seconds 45 seconds-1 minute 1-1½ minute	Place meat on microwavable roast rack. Cover loosely with waxed paper. After cooking let stand 1 minute.
Chops (5-7 oz. each) 2 chops 4 chops	3	19-20 minutes per pound 16-17 minutes per pound (165°F)	Place chops in microwavable baking dish. Add desired seasonings and cover with plastic wrap vent. Turn over chops halfway through cooking. Let stand covered 5 minutes. (Temperature may rise about 10°F).
Hot dogs 1 2 4	HIGH	20-30 seconds 30-45 seconds 45 seconds-1 minutes	Pierce hot dogs and place on microwavable roast rack. Cover with waxed paper. If in bun, wrap in paper towel or paper napkin to absorb moisture. After cooking, let stand 1 minute.
Ham, boneless fully cooked 2 lbs. 5 lbs.	5	13-14 minutes per pound	Place ham on microwavable roast rack. Cover with waxed paper. Turn over ham halfway through cooking. Let stand covered 10 minutes.
Ham, center slice (1 lb.)	7	4½-5½ minutes	Place slices on microwavable roast rack. Cover with plastic wrap vent. Let stand covered 1 minute.
Loin Roast, rolled, boneless (3½-4½ lbs.)	3	16-17 minutes per pound (165°F)	Place roast in cooking bag in microwavable dish. Add seasonings and browning agent if desired. Close bag loosely with microwavable closure or string. Turn over roast halfway through cooking. After cooking let stand in bag 15 minutes. (Temperature may rise about 10°F). Internal temperature of pork should reach 170°F before serving.
Sausage links, Fresh (1-2 oz. each) 2 links 4 links 6 links	HIGH	45-60 seconds 1¼-1½ minutes 1½-2 minutes	Pierce links and place on microwavable roast rack. Cover with waxed paper or paper towel. After cooking let stand covered 1 minute.

MEAT COOKING TABLE (continued)

Meat	Power Level	Cooking Time	Special Instructions
Sausage patties, Fresh (2 oz. each) 2 patties 4 patties 8 patties	HIGH	1½-2 minutes 2½-3 minutes 4½-5 minutes	Place sausage patties in a circle on microwavable roast rack. Brush with browning agent if desired. Cover with waxed paper. Turn patties over halfway through cooking. After cooking let stand 2 minutes.
Spareribs (2½-3½ lbs.)	5 then 5	22-27 minutes per pound (165°F) 10 minutes	Place ribs, cut into serving size pieces, bone side down in large cooking bag. Place bag in 3-quart microwavable casserole. Add 1 cup water to bag. Close bag loosely with microwavable closure or string. Turn over ribs, rearranging carefully, halfway through cooking. Cook until meat is fork-tender. Carefully remove ribs. If desired, brush sauce over ribs. Cook covered with waxed paper. Let stand covered 10 minutes. (Temperature may rise about 10°F). * Internal temperature of pork should reach 170°F before serving.

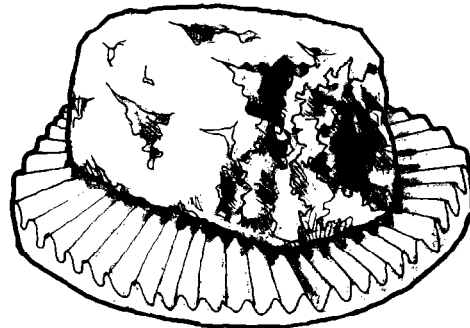
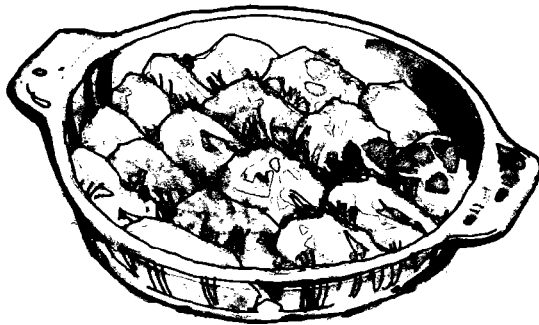

Stuffed Flank Steak

- 1 cup finely chopped onion
- 1 clove garlic, minced
- ¼ cup butter or margarine
- 1 package (10 ounces) frozen chopped spinach, thawed and well drained
- ¼ teaspoon ground thyme
- ¼ teaspoon ground black pepper
- 1 beef flank steak (about 1½ pounds)
- 1 cup beef broth
- 1 can (10¾ ounces) condensed cream of mushroom soup
- ¼ cup white wine (optional)

1. Combine onion, garlic, and butter in a 2-quart microwavable casserole. Cook uncovered 5 to 6 minutes at Power Level 10 or until onion is tender; stir once. Add spinach, thyme, and pepper. Cook covered 3 minutes at Power Level 10. Stir once.
2. Pound flank steak with mallet to flatten. Spread spinach mixture on steak and roll up jellyroll-fashion starting from the long edge. Tie with string. Place in 2-quart microwavable casserole.
3. Combine remaining ingredients and pour over steak. Cook covered 8½ minutes at Power Level 10. Cook covered 45 to 50 minutes per pound at Power Level 3 or until tender; turn steak over twice during cooking. Let stand covered 10 minutes.

Makes 4 servings.

POULTRY

Microwave-cooked chicken is juicy and succulent. Whole poultry becomes golden but not crisp. For the crisper, conventional crust, pop the poultry in your conventional oven at 450°F for 10 to 15 minutes. The same technique is also convenient when barbequing. Defrost and precook in your microwave oven then flash-cook on the grill for that barbeque flavor.

Cooking Poultry: Tips & Techniques

- Defrost poultry completely before cooking.
- Arrange poultry so that thicker pieces face the outside of the baking dish. If cooking legs, arrange them like spokes of wheels.
- Cover the baking dish with waxed paper to minimize spattering.
- Turn over both whole poultry and poultry pieces to ensure even cooking.
- Drain and discard juices as they accumulate.
- Shield thin or bony pieces with small strips of aluminum foil to prevent over cooking. Keep foil at least one inch from oven walls and other pieces of foil.
- Use a browning agent or cook with a sauce to give browned appearance.
- Cook poultry until no longer pink and juices run clear. Temperatures in thigh meat should be 185°F when done. Let stand covered with foil 10 minutes.

POULTRY COOKING TABLE

Poultry	Power Level	Cooking Time	Special Instructions
CHICKEN Breasts, boneless 1 half breast (4-5 oz.) 1 whole breast (10-12 oz.) 2 whole breasts (20-24 oz.)	HIGH	6-6½ minutes per pound 5½-6½ minutes per pound 5-6 minutes per pound	Wash and dry poultry. Remove skin and place breasts, thickest portion to outside, in microwavable baking dish. Brush with butter or browning agent and seasonings if desired. Cover with waxed paper. Cook until no longer pink and juices run clear. Let stand covered 3 minutes.
Cut up fryer (2½-3 lbs.)	HIGH	5-6 minutes per pound	Wash and dry poultry. Place pieces in single layer in microwavable baking dish with thicker pieces to the outside. Brush with butter or browning agent and seasonings if desired. Cover with waxed paper. Cook until no longer pink and juices run clear. Let stand covered 5 minutes.
Whole (3-3½ lbs.)	5	13-14 minutes per pound	Wash and dry poultry. Place breast side down on microwavable roast rack. Brush with butter, or browning agent and seasoning if desired. Cover with waxed paper. Cook ⅓ of estimated time. Turn breast side up, brush on butter, or browning agent. Replace waxed paper. Cook ⅓ of estimated time again. Shield if necessary. Cook remaining ⅓ of estimated time or until no longer pink and juices run clear. Let stand covered with foil 10 minutes. (Temperature may rise about 10°F). Temperature in thigh should be 180°F-185°F when done.

POULTRY COOKING TABLE (continued)

Poultry	Power Level	Cooking Time	Special Instructions
TURKEY Breast, boneless (2-3 lbs.)	5	18-20 minutes per pound	Place thawed turkey breast, on microwavable roast rack. Cover with waxed paper. Cook $\frac{1}{3}$ of estimated time. Turn breast over. Replace waxed paper. Cook $\frac{1}{3}$ of estimated time again. Turn breast over. Shield if necessary. Cook remaining $\frac{1}{3}$ of estimated time or until no longer pink and juices run clear. Remove from microwave when desired temperature is reached. Let stand covered with foil 10 minutes. (Temperature may rise about 10°F). Temperature in breast should be 170°F before serving.
Breast, whole (4-9 lbs.)	HIGH then 5	4 minutes per pound 7-8 minutes per pound	Wash and dry poultry. Place turkey breast meat side down on microwavable roast rack. Brush with butter or browning agent and seasonings if desired. Cover with waxed paper. After first cooking time is done turn meat side up. Remove and discard drippings. Brush on butter or browning agent and seasonings if desired. Replace waxed paper. Cook until no longer pink and juices run clear. Remove breast from microwave when desired temperature is reached. Let stand covered with foil 10 minutes. (Temperature may rise about 10°F). Temperature in breast should be 170°F before serving.
Drumsticks (1½-2 lbs.)	5	14-16 minutes per pound	Wash and dry poultry. Place pieces with thickest portion to outside on microwavable roast rack. Brush with butter or browning agent and seasonings if desired. Cover with waxed paper. Turn over pieces, shield bone ends with small pieces of foil and replace waxed paper halfway through cooking. Cook until no longer pink and juices run clear. Let stand covered 5 minutes.
Whole (up to 12 lbs.)	HIGH then 5	4 minutes per pound then 6-7 minutes per pound	Wash and dry poultry. Place turkey, breast side down, on microwavable roast rack. Brush with butter or browning agent and seasonings if desired. Cover with waxed paper. Turn breast side up. Brush with butter or browning agent before cooking at PL 5, if desired. Remove and discard drippings 1 or 2 times during second cooking time. Cook until no longer pink and juices run clear. Let stand covered with foil 15 minutes. (Temperature may rise about 10°F). Temperature in breast should be 170°F and temperature in thigh should be 185°F before serving.
CORNISH HENS Whole (1-1½ lbs. each)	HIGH	4½-5½ minutes per pound	Wash and dry poultry. Tie wings to body of hen and the legs to tail. Place hens breast side down on microwavable roast rack. Cover with waxed paper. Shield bone ends of drumsticks with foil. Remove and discard drippings. Brush with butter or browning agent and seasonings if desired. Cook until no longer pink and juices run clear. Remove hens from microwave when desired temperature is reached. Let stand covered with foil 5 minutes. (Temperature may rise about 10°F). Temperature in breast should be 170°F before serving.
DUCKLING (4-5 lbs.)	HIGH then 5	10 minutes 7-9 minutes per pound	Wash and dry poultry. Tie legs together and the wings to body. Place breast side down on microwavable roast rack. Brush with butter or browning agent and seasonings if desired. Cover with waxed paper. Turn breast side up halfway through second cooking time. Shield if necessary. Remove and discard fat 1 or 2 times during cooking. Let stand covered with foil 10 minutes. (Temperature may rise about 10°F). Temperature in breast should be 170°F before serving.

FISH & SHELLFISH

Fish and shellfish cook well in the microwave. Their naturally high moisture content means fast cooking. In just a few minutes, your seafood will be tender and moist, keeping its true flavor and mild taste.

Cooking Fish & Shellfish: Tips & Techniques

- Completely defrost fish and shellfish before cooking.
- Arrange unevenly shaped pieces with thicker parts toward the outside of the dish. Arrange shellfish in a single layer for even cooking.
- Always use the shortest cooking time. Fish is done the moment it turns opaque and the thickest part begins to flake. Shellfish is done when the shell turns from pink to red and the flesh is opaque and firm.
- The type of cover used will determine whether fish is baked or poached. For poached fish cover with microwavable lid or plastic wrap, vented; for baked fish place waxed paper over container.
- Cook fish that is coated or prepared with sauce uncovered or lightly covered with waxed paper. This keeps the coatings from becoming soggy and the sauce from getting watery.

FISH AND SHELLFISH COOKING TABLE

Fish	Power Level	Cooking Time Minutes Per Pound	Special Instructions
Fish fillets	HIGH	4 to 5 minutes	Arrange fish in single layer with thickest portion toward outside edge of 1½ to 2-quart microwavable baking dish. Brush with melted butter and season, if desired. Cook covered with plastic wrap; vented. Let stand covered 2 minutes.
Fish steaks	HIGH	4 to 5 minutes	
Whole fish	7	5½ to 6½ minutes	
Scallops	HIGH	4 to 5 minutes	Prepare as directed above.
Shrimp, shelled	HIGH	4 to 5 minutes	
Lobster tail	HIGH	4 to 5 minutes	Cut hard shell down middle with knife. Grasp tail with both hands and open flat. Place flesh side up in 8×8×2-inch square glass baking dish. Cook covered with waxed paper. Let stand covered 2 minutes.

Poached Fish Fillets

- 4 Orange Roughly fillets (1 to 1¼ pound)**
- ½ cup dry white wine**
- 3 tablespoons butter, or margarine cut into ¼-inch slices**
- 2 tablespoons finely chopped green onion**
- ¼ teaspoon ground black pepper**

1. Arrange fillets with thicker piece to the outside in a 2-quart microwavable baking dish. Pour wine over fillets. Dot with butter. Sprinkle with onion and pepper.
2. Cook covered with waxed paper 3½ to 5½ minutes at Power Level 10 or until fish flakes easily when tested with fork. Let stand covered 5 minutes.

Makes 4 servings.

Baked Whitefish Meuniere

- ½ cup butter or margarine, cut into pieces**
- ¼ cup finely chopped parsley**
- 1 tablespoon lemon juice**
- 1½ to 2½ pounds whole whitefish, cleaned**

1. Combine butter, parsley and lemon juice in a 1½-quart microwavable baking dish. Cook uncovered 1 to 2 minutes at Power Level 10 or until butter is melted; stir once.
2. Place fish in baking dish and turn to coat with butter mixture. Cover with plastic wrap; vent. Cook 10 to 11 minutes at Power Level 7 or until fish flakes easily when tested with fork; turn fish over after 5 minutes cooking. Let stand covered 5 minutes.

Makes 3 to 4 servings.

CAKES & PIES

Make your very next cake or pie in the microwave. Not only do they cook in half the time, but they are delicious! Cakes are superior in texture, height, and lightness to conventional ones. Pie crust comes out extra flaky.

Microwave Cakes & Pies: Tips & Techniques

- When making pie fillings, slightly reduce the amount of liquid given in the conventional recipe.
- Pastry will not brown, but it does come out extra flaky. To add color, brush prepared shell with vanilla extract before cooking.
- All pies should be cooked in a microwavable pie plate. Prick pastry before cooking. To check, the bottom of the crust should look opaque and dry.
- Crumb crusts work well in the microwave.
- Because microwave cooked cakes rise much higher than those conventionally baked, fill dish only half full.
- Cakes are done when a toothpick inserted near the center of the layer comes out clean. There may be some moist spots on top immediately after removing from the oven. These will disappear during the stand time.
- Angel food cake, chiffon cake and cream puffs need dry heat so bake in a conventional oven for best results.

CONVENIENCE CAKES AND MIXES COOKING TABLE

Cakes & Mixes	Power Level	Cooking Time	Special Instructions
Brownie Mix (23.6 oz.)	7	14-15 minutes	Prepare as directed on package. Spread batter into greased 7x11-inch microwavable baking dish. Shield corners with foil halfway through cooking. When done, top will appear puffy and dry and will spring back when lightly pressed with finger. Let stand covered with waxed paper on flat surface 10 minutes. Remove waxed paper. Cool before cutting.
Cake, layer (17-18½ oz.)	7	5-6 minutes	Prepare as directed on package. Divide batter between two paper towel-lined 8-inch microwavable cake dishes. Fill each dish half full. Any extra batter may be used for cupcakes. Cover with paper towel. When done, wooden pick inserted near center will come out clean. Let stand covered on flat surface 5 minutes. Invert onto serving plate. Carefully remove paper towel. Repeat with second layer.
Cake, tube (17-18½ oz.)	7	10-12 minutes	Prepare as directed on package. Pour batter into paper towel-lined 10- to 12-cup microwavable fluted tube dish. Cover with paper towel. When done, wooden pick inserted near center will come out clean. Let stand covered on flat surface 10 minutes. Invert onto serving plate. Cool.

CONVENIENCE CAKES AND MIXES COOKING TABLE (continued)

Cakes & Mixes	Power Level	Cooking Time	Special Instructions
Cupcakes			
4 cupcakes	7	1½-2 minutes	Prepare as directed on package. Place 2 paper cupcake liners in each microwavable muffin ring cup. Fill each cup two-thirds full with batter (about 3 tablespoons). When done, tops will appear moist and wooden pick inserted near center will come out clean. Let stand 2 minutes. Remove cupcakes to rack. Repeat with remaining batter.
6 cupcakes	7	2-2½ minutes	
Date Bread Mix (17 oz.)	7	10-11 minutes	Prepare as directed on package. Pour batter into waxed paper-lined 9x5x3-inch microwavable loaf dish. Shield corners with foil halfway through cooking. When done, top will appear moist and wooden pick inserted near center will come out clean. Let stand covered with waxed paper on flat surface 5 minutes. Remove from dish and carefully peel off waxed paper. Cool on rack.
Muffins (13 oz.)	7	2½-3 minutes	Prepare as directed on package. Place 2 paper liners in each microwavable muffin ring cup. Fill each cup two-thirds full with batter (about 3 tablespoons). When done, tops will appear moist and wooden pick inserted near center will come out clean. Let stand 2 minutes. Remove muffins to rack. Repeat with remaining batter.

Fruitcake

1 cup chopped dried apricots
1 cup raisins or dried currants
1 cup slivered almond
¾ cup candied cherries, halved
¾ cup candied pineapple
¾ cup flour
¾ cup packed dark brown sugar
½ cup shortening
3 eggs
2 tablespoons rum or brandy
2 teaspoons vanilla extract
¼ teaspoon almond extract
½ teaspoon ground nutmeg or mace
½ teaspoon baking powder
½ teaspoon salt

1. Line a 10 to 12-cup microwavable tube dish with paper towels; set aside.
 2. Combine ingredients in a mixing bowl; blend thoroughly. Pour batter into prepared pan. Cook covered with paper towel 12 to 13 minutes at Power Level 7 or until cake pulls away from the sides of the pan. Let stand 15 minutes on a flat surface before inverting onto a rack to cool. To store, wrap in foil or plastic wrap and refrigerate no longer than 4 weeks.

Makes 1 cake.

VEGETABLES

VEGETABLE COOKING TABLE

Vegetables	Cooking Time	Special Instructions
Beets Fresh (1 lb.)	HIGH 14½-15½ minutes	Place beets and ¼ cup water in 1½-quart microwavable covered casserole. Rearrange halfway through cooking. Cook until beets pierce easily with fork. Let stand covered 2 minutes. Peel after cooking.
Broccoli Fresh, spears (1 lb.)	HIGH 5-6 minutes	Place broccoli in single layer in 2-quart baking dish with flowerets toward center of dish. Add 2 tablespoons water. Cover with plastic wrap and vent. Cook until tender-crisp. Let stand covered 2 minutes.
Frozen, chopped (10 oz.)	HIGH 6-7 minutes	Remove outer wrapping from box. Place on 2 paper towels. After cooking let stand 2 minutes.
Frozen, spears (10 oz.)	HIGH 5½-6½ minutes	
Brussels Sprouts Fresh, (1 lb.) 3-4 cups	HIGH 5½-6½ minutes	Place Brussel sprouts and 2 tablespoons water in 2-quart microwavable covered casserole. Stir halfway through cooking. Cook until tender-crisp. Let stand covered 2 minutes.
Frozen, (10 oz.)	HIGH 5½-6½ minutes	Remove outer wrapping from box. Place box on 2 paper towels. After cooking let stand 2 minutes.
Cabbage Fresh, chopped (1 lb.) 1 medium	HIGH 6½-7½ minutes	Place cabbage and ¼ cup water in 2-quart microwavable covered casserole. Stir halfway through cooking. Cook until tender-crisp. Let stand covered 2 minutes.
Wedges (1 lb.) 1 medium	HIGH 6½-7½ minutes	Place cabbage and ¼ cup water in 2-quart microwavable covered casserole. Cook until tender-crisp. Let stand covered 2 minutes.
Carrots Fresh, sliced 2 cups	HIGH 5-6 minutes	Place carrots and 2 tablespoons water in 1-quart covered casserole. Stir halfway through cooking. Cook until fork-tender. Let stand covered 2 minutes.
Frozen, crinkle cut (10 oz.)	HIGH 5½-6½ minutes	Remove outer wrapping from box. Place box on 2 paper towels. After cooking let stand 2 minutes.
Frozen, whole baby (10 oz. pouch)	HIGH 6½-7½ minutes	Remove pouch from box. Pierce pouch with fork. Place in 1½-quart microwavable casserole. After cooking let stand 2 minutes.
Cauliflower Fresh, whole (1 lb.)	HIGH 6-7 minutes	Place trimmed cauliflower and 2 tablespoons water in 1 or 1½-quart covered microwavable casserole. Cook until tender-crisp. Let stand covered 2 minutes.
Fresh, flowerets 2 cups	HIGH 3-4 minutes	
Frozen, flowerets (10 oz.)	HIGH 4½-5½ minutes	Remove outer wrapping from box. Place box on 2 paper towels. After cooking let stand 2 minutes.
Celery Fresh, sliced 4 cups, 1 inch pieces	HIGH 6-7 minutes	Place sliced celery and 2 tablespoons water in 1½-quart covered microwavable casserole. Stir halfway through cooking. Cook until tender-crisp. Let stand covered 2 minutes.

VEGETABLES

VEGETABLE COOKING TABLE

Vegetables	Cooking Time	Special Instructions
Beets Fresh (1 lb.)	HIGH 14½-15½ minutes	Place beets and ¼ cup water in 1½-quart microwavable covered casserole. Rearrange halfway through cooking. Cook until beets pierce easily with fork. Let stand covered 2 minutes. Peel after cooking.
Broccoli Fresh, spears (1 lb.)	HIGH 5-6 minutes	Place broccoli in single layer in 2-quart baking dish with flowerets toward center of dish. Add 2 tablespoons water. Cover with plastic wrap and vent. Cook until tender-crisp. Let stand covered 2 minutes.
Frozen, chopped (10 oz.)	HIGH 6-7 minutes	Remove outer wrapping from box. Place on 2 paper towels. After cooking let stand 2 minutes.
Frozen, spears (10 oz.)	HIGH 5½-6½ minutes	
Brussels Sprouts Fresh, (1 lb.) 3-4 cups	HIGH 5½-6½ minutes	Place Brussel sprouts and 2 tablespoons water in 2-quart microwavable covered casserole. Stir halfway through cooking. Cook until tender-crisp. Let stand covered 2 minutes.
Frozen, (10 oz.)	HIGH 5½-6½ minutes	Remove outer wrapping from box. Place box on 2 paper towels. After cooking let stand 2 minutes.
Cabbage Fresh, chopped (1 lb.) 1 medium	HIGH 6½-7½ minutes	Place cabbage and ¼ cup water in 2-quart microwavable covered casserole. Stir halfway through cooking. Cook until tender-crisp. Let stand covered 2 minutes.
Wedges (1 lb.) 1 medium	HIGH 6½-7½ minutes	Place cabbage and ¼ cup water in 2-quart microwavable covered casserole. Cook until tender-crisp. Let stand covered 2 minutes.
Carrots Fresh, sliced 2 cups	HIGH 5-6 minutes	Place carrots and 2 tablespoons water in 1-quart covered casserole. Stir halfway through cooking. Cook until fork-tender. Let stand covered 2 minutes.
Frozen, crinkle cut (10 oz.)	HIGH 5½-6½ minutes	Remove outer wrapping from box. Place box on 2 paper towels. After cooking let stand 2 minutes.
Frozen, whole baby (10 oz. pouch)	HIGH 6½-7½ minutes	Remove pouch from box. Pierce pouch with fork. Place in 1½-quart microwavable casserole. After cooking let stand 2 minutes.
Cauliflower Fresh, whole (1 lb.)	HIGH 6-7 minutes	Place trimmed cauliflower and 2 tablespoons water in 1 or 1½-quart covered microwavable casserole. Cook until tender-crisp. Let stand covered 2 minutes.
Fresh, flowerets 2 cups	HIGH 3-4 minutes	
Frozen, flowerets (10 oz.)	HIGH 4½-5½ minutes	
Celery Fresh, sliced 4 cups, 1 inch pieces	HIGH 6-7 minutes	Place sliced celery and 2 tablespoons water in 1½-quart covered microwavable casserole. Stir halfway through cooking. Cook until tender-crisp. Let stand covered 2 minutes.

VEGETABLE COOKING TABLE (continued)

Vegetables	Cooking Time	Special Instructions
Peas, black eyed Frozen (16 oz.)	HIGH 9-10 minutes	Place peas and 2 tablespoons water in 1½-quart covered microwavable casserole. Stir halfway through cooking. Let stand covered 2 minutes.
Peas, green Fresh (1 lb.) 4 cups	HIGH 11-13 minutes	Place shelled peas and 2 tablespoons water in 1½-quart covered microwavable casserole. Stir halfway through cooking. Let stand covered 2 minutes.
Frozen (9 oz. pouch)	HIGH 3-4 minutes	Remove outer wrapping from box or pouch. Place box on 2 paper towels. Pierce pouch with fork and place in 1½-quart microwavable casserole. After cooking let stand 2 minutes.
Frozen (10 oz.)	HIGH 3½-4½ minutes	
Potatoes, sweet cut up (6-8 oz. each) 3 medium	HIGH 6½-7½ minutes	Place potatoes and 2 tablespoons water in 1½-quart microwavable covered casserole. Stir halfway through cooking. Let stand covered 2 minutes.
Whole, (6-8 oz. each) 1 medium potato	HIGH 2-4 minutes	Pierce potatoes several times with fork. Place in circle on 2 paper towels. Turn over potatoes and rearrange halfway through cooking. Remove potatoes when soft to the touch. Wrap in foil and let stand 5 minutes.
2 medium potatoes	4-6 minutes	
4 medium potatoes	6-8 minutes	
Potatoes, white cut up (6-8 oz. each) 4 medium	HIGH 9-11 minutes	Place potatoes and 2 tablespoons water in 1½-quart covered microwavable casserole. Stir halfway through cooking. Let stand covered for 2 minutes.
White, whole baking (6-8 oz. each) 1 potato	HIGH 3½-5½ minutes	Pierce potatoes several times with fork. Place in circle on 2 paper towels. Turn over potatoes and rearrange halfway through cooking. Remove potatoes when soft to touch. Wrap in foil and let stand 5 minutes.
2 potatoes	5½-7½ minutes	
4 potatoes	10-12 minutes	
Rutabaga Fresh, whole (1 lb.)	HIGH 9½-10½ minutes	Pierce rutabaga through waxy coating several times with fork. Place on 2 paper towels. Remove halfway through cooking. Cut into quarters, peel and dice. Place diced rutabaga and 2 tablespoons water in 1½-quart microwavable covered casserole. After cooking let stand covered 2 minutes.
Spinach Fresh, leaf (1 lb.)	HIGH 5½-6½ minutes	Place spinach and 2 tablespoons water in 3-quart covered microwavable casserole. After cooking let stand covered 2 minutes.
Frozen, chopped (9 oz. pouch) (10 oz.)	HIGH 4½-5½ minutes 4-5 minutes	Remove outer wrapping from box or pouch. Place box on 2 paper towels. Pierce pouch with fork and place in 1½-quart microwavable casserole. After cooking let stand 2 minutes.
Frozen, leaf (10 oz.)	HIGH 6½-7½ minutes	

VEGETABLE COOKING TABLE (continued)

Vegetables	Cooking Time	Special Instructions
Squash, spaghetti Fresh, (2-3 lbs.) 1 medium whole	HIGH 11-12 minutes	Pierce squash several times with fork. Place squash on 2 paper towels. Turn over several times during cooking. Let stand 2 minutes. Cut in half. Remove fibrous strands and seeds from center.
Succotash, Frozen, (10 oz.)	HIGH 5-6 minutes	Remove outer wrapping from box. Place box on 2 paper towels. After cooking let stand 2 minutes.
Turnips, Fresh, (1 lb.)	HIGH 9-10 minutes	Pierce turnips through waxy coating several times with fork. Place on paper towel. Remove halfway through cooking. Cut into quarters, peel and dice. Place diced turnips and 2 tablespoons water into 1½-quart microwavable covered casserole. After cooking let stand covered 2 minutes.
Zucchini Fresh, sliced (1 lb.) 4 cups	HIGH 7-8 minutes	Place zucchini and 2 tablespoons water in 1½-quart microwavable covered casserole. Stir halfway through cooking. Let stand covered 2 minutes.
Fresh, whole, (1 lb.)	HIGH 6-7 minutes	Pierce zucchini several times with fork. Place on 2 paper towels. Turn zucchini over and rearrange halfway through cooking. Let stand 2 minutes.
Frozen, sliced (16 oz.)	HIGH 7-8 minutes	Remove outer wrapping from box. Place box on 2 paper towels. After cooking let stand 2 minutes.

NOTE: Frozen vegetables in larger or smaller quantities than listed in the chart or those in non-microwavable bags may be cooked approximately 3 to 4 minutes per cup of vegetables. Measure desired amount of vegetables into microwavable covered casserole and cook.

RECIPES

15 tortilla chips
3 tablespoons jalapeno bean dip
½ cup shredded Cheddar cheese

Nachos

1. Spread each tortilla chip with bean dip; top with cheese. Place chips on a paper plate.
2. Cook uncovered 1 to 1½ minutes at Power Level 6 or until cheese is melted.

Makes 15 appetizers.

1 can (3¾ ounces) tuna, drained and flaked
1 package (3 ounces) cream cheese, softened
2 tablespoons crushed pineapple, drained
½ tablespoon white vinegar
⅙ teaspoon curry powder
24 crackers or melba toast rounds

Sweet and Sour Tuna Crackers

1. Combine ingredients, except crackers in a mixing bowl; blend thoroughly.
2. Spread mixture on crackers. Arrange 8 crackers in a circle on a paper plate. Cook uncovered 25 to 30 seconds at Power Level 10 or until tuna mixture bubbles. Repeat with remaining crackers.

Makes 24 appetizers.

½ cup finely chopped onion
1 clove garlic, pressed or finely chopped
2 tablespoons olive oil
1 can (15 ounces) tomato sauce
1½ teaspoons dried basil leaves
1½ teaspoons dried oregano leaves
¼ teaspoon ground black pepper

Spaghetti Sauce

1. Combine onion, garlic, and oil in a 1-quart microwavable casserole. Cook uncovered 1 to 1½ minutes at Power Level 10 or until onion is tender.
2. Add remaining ingredients. Cook covered 3 minutes at Power Level 10 and then 8½ minutes at Power Level 5; stir twice.

Makes about 1¾ cups.

¼ cup sugar
1 tablespoon cocoa
1 teaspoon flour
dash of salt
2 tablespoons milk
2 teaspoons butter or margarine
2 teaspoons light corn syrup
¼ teaspoon vanilla extract

Chocolate Sauce

1. Combine dry ingredients in a 1-quart glass measuring cup; stir in milk. Add butter and corn syrup.
2. Cook uncovered 1 to 2 minutes at Power Level 10 or until sauce is thickened and smooth; stir twice. Stir in vanilla extract.

Makes ½ cup.

Onion Soup

- 1 cup thinly sliced onions
- 2 tablespoons butter or margarine
- 1 can (10½ ounces) condensed beef broth
- 1 slice of toasted French bread
- ½ cup shredded Swiss cheese
- 2 tablespoons grated Parmesan cheese

1. Combine onions and butter in a 1-quart microwavable casserole. Cook uncovered 2 to 3 minutes at Power Level 10 or until onions are soft; stir twice.
2. Add beef broth. Cook uncovered 2½ to 3½ minutes at Power Level 10 or until hot; stir once after 2 minutes.
3. Ladle into large soup bowl. Cover with bread slice and sprinkle with cheeses. Cook uncovered 45 seconds to 1 minute at Power Level 10 or until cheese is melted.

Makes 1 serving.

Cheesy Meatloaf

- ½ pound ground lean beef
- 1 egg, slightly beaten
- ⅓ cup soft, fresh bread crumbs
- ¼ cup shredded Cheddar cheese
- 3 tablespoons finely chopped onion
- 2 tablespoons tomato sauce
- 1 tablespoon finely chopped green pepper
- ⅛ teaspoon dried thyme leaves
- ⅛ teaspoon salt
- ⅛ teaspoon ground black pepper

1. Combine ingredients in a mixing bowl; mix thoroughly.
2. Shape into loaf and place on a microwavable roast rack. Cook covered with waxed paper 3½ to 4½ minutes at Power Level 10 or until center is no longer pink. Let stand covered 5 minutes.

Makes 2 servings.

Barbecued Chicken

- 1½ to 2 pounds chicken pieces, skinned
- ½ cup barbecue sauce

1. Arrange chicken with thicker pieces to the outside in an 8×8×2-inch square glass baking dish. Cook covered with waxed paper 2 minutes at Power Level 10. Drain and turn chicken over.
2. Brush half of barbecue sauce onto chicken. Cook covered 2 minutes at Power Level 10. Turn chicken over and brush with remaining sauce; cook covered 6½ to 7½ minutes at Power Level 10 or until juices run clear. Let stand covered 3 minutes.

Makes 2 servings.

Sherried Chicken

- 2½ to 3 pound chicken, cut into serving pieces, skinned
- ¼ teaspoon ground black pepper
- 1 large onion, thinly sliced
- ⅓ cup dry sherry
- 1 tablespoon soy sauce
- 1 tablespoon lemon juice
- 1 tablespoon flour

1. Arrange chicken with thicker pieces to the outside in an 8×8×2-inch square glass baking dish. Sprinkle with pepper and top with onion. Combine remaining ingredients in a bowl. Pour mixture evenly over chicken. Cover with plastic wrap; vent.
2. Cook 15 to 17 minutes at Power Level 10 or until chicken is no longer pink and juices run clear; turn over halfway through cooking. Let stand covered 5 minutes. Stir pan juices until smooth and spoon over chicken.

Makes 4 servings.

Basic Scrambled Eggs

Eggs	Tablespoons of Milk	Teaspoons of Butter	Cooking time Power Level 7	Special Instructions
1	1	1	50 to 60 seconds	Use 10-ounce microwavable bowl or custard cup for 1 to 2 eggs; use 1-quart microwavable casserole for 4 to 6 eggs. Place butter in dish. Cook uncovered 20 to 40 seconds at Power Level 10 or until butter melts. Beat eggs and milk together with fork until well blended; stir into melted butter. Cook uncovered as directed in chart at Power Level 8. Break up and stir eggs with fork halfway through cooking. Cover with waxed paper and let stand 1 to 3 minutes. Stir and season to taste.
2	2	2	2 to 2½ minutes	
4	4	4	3½ to 4 minutes	
6	6	6	5 to 6 minutes	

Basic Omelet

1 tablespoon butter or margarine
2 eggs
2 tablespoons milk
¼ teaspoon salt
dash of ground black pepper

- Place butter in a 9-inch glass pie plate. Cook uncovered 15 to 20 seconds at Power Level 10 or until melted. Tilt plate to cover bottom with melted butter.
- Beat eggs, milk, salt, and pepper in a small bowl. Pour mixture into pie plate. Cook uncovered 2 to 3 minutes at Power Level 7 or until almost set; stir after 1 minute. Cover with plastic wrap and let stand 2 minutes.

Makes 1 to 2 servings.

Cheeseburgers

1 pound ground lean beef
4 slices American process cheese
4 hamburger buns

- Shape ground beef into four 4-inch patties. Arrange on a microwavable roast rack. Cover with waxed paper and cook 3 to 3½ minutes at Power Level 10 or until desired doneness; turn patties over halfway through cooking; drain liquid.
- Top patties with cheese. Cook 30 seconds at Power Level 6. Let stand 2 minutes. Serve on hamburger buns.

Makes 4 servings.

Reuben Sandwiches

8 slices dark rye or pumpernickel bread, toasted
½ pound cooked corned beef, sliced
1 can (8 ounces) sauerkraut, rinsed and drained
½ cup creamy Russian or Thousand Island dressing
4 slices Swiss cheese

- Layer corned beef, sauerkraut, and dressing on 4 bread slices. Top each with cheese and remaining bread slices. Wrap each sandwich with a paper towel and place on a microwavable roast rack.
- Cook 4½ to 5½ minutes at Power Level 5 or until sandwich is heated through.

Makes 4 servings.

3/4 cup milk
2 eggs
2 tablespoons sugar
2 tablespoons grated lemon peel
1/2 teaspoon vanilla extract
pinch of salt
ground nutmeg

Egg Custard

1. Pour milk into a 2-cup glass measuring cup. Cook 3½ to 4½ minutes at Power Level 6 or until almost boiling. Beat eggs slightly in a mixing bowl; add remaining ingredients except nutmeg. Stir milk into egg mixture.
2. Pour custard mixture into two buttered 6-ounce custard cups. Place cups in oven. Cook uncovered 7 to 8 minutes at Power Level 4 or until set. Remove cups and sprinkle with nutmeg. Set on rack to cool.

Makes 2 servings.

1/4 cup butter or margarine
1 package (3½ ounces) instant vanilla pudding
1 teaspoon cinnamon
3 eggs, slightly beaten
3 cups milk
1 can (8¼ ounces) crushed pineapple, undrained
1/2 cup flaked coconut
1 teaspoon rum extract (optional)
8 slices white bread, French bread, or raisin-nut bread, cut into 1/2-inch cubes
1 tablespoon cinnamon-sugar

Pineapple Bread Pudding

1. Melt butter in a 2-quart glass measuring cup 45 seconds at Power Level 10. Add pudding mix, cinnamon, eggs, milk, undrained pineapple, coconut and rum extract; blend thoroughly.
2. Fold in bread cubes. Pour mixture into a 2-quart microwavable baking dish. Sprinkle with cinnamon-sugar. Cook uncovered 30 to 32 minutes at Power Level 7 or until knife inserted near center comes out clean. Let stand on a flat surface for 10 minutes. Serve warm.

Makes 12 servings.

1/2 cup butterscotch pieces
2 tablespoons butter or margarine
2½ cups miniature marshmallows
2½ cups crisp rice cereal

Butter Scotch Krispie Treats

1. Combine butterscotch pieces and butter in a 2-quart microwavable glass casserole. Cook uncovered 2 to 3 minutes at Power Level 7 or until melted. Stir in marshmallows. Cook uncovered 3 to 4½ minutes at Power Level 6 or until marshmallows are softened; stir twice. Blend until smooth.
2. Stir rice cereal into marshmallow mixture. Press into buttered 8×8×2-inch microwavable baking dish. Let stand until cool and set. Cut into squares.

Makes about 25 squares.

3/4 cup water
1 rounded teaspoon instant coffee granules
2 teaspoons sugar
2 tablespoons Irish whiskey
whipped cream

Irish Coffee

1. Combine water, instant coffee, and sugar in an 8-ounce microwavable coffee cup. Cook uncovered 1 to 1½ minutes at Power Level 10 or until hot.
2. Stir in whiskey and garnish with whipped cream.

Makes about 1 cup.

3/4 cup milk
2 eggs
2 tablespoons sugar
2 tablespoons grated lemon peel
1/2 teaspoon vanilla extract
pinch of salt
ground nutmeg

Egg Custard

1. Pour milk into a 2-cup glass measuring cup. Cook 3½ to 4½ minutes at Power Level 6 or until almost boiling. Beat eggs slightly in a mixing bowl; add remaining ingredients except nutmeg. Stir milk into egg mixture.

2. Pour custard mixture into two buttered 6-ounce custard cups. Place cups in oven. Cook uncovered 7 to 8 minutes at Power Level 4 or until set. Remove cups and sprinkle with nutmeg. Set on rack to cool.

Makes 2 servings.

1/4 cup butter or margarine
1 package (3½ ounces) instant vanilla pudding
1 teaspoon cinnamon
3 eggs, slightly beaten
3 cups milk
1 can (8¼ ounces) crushed pineapple, undrained
1/2 cup flaked coconut
1 teaspoon rum extract (optional)
8 slices white bread, French bread, or raisin-nut bread, cut into 1/2-inch cubes
1 tablespoon cinnamon-sugar

Pineapple Bread Pudding

1. Melt butter in a 2-quart glass measuring cup 45 seconds at Power Level 10. Add pudding mix, cinnamon, eggs, milk, undrained pineapple, coconut and rum extract; blend thoroughly.

2. Fold in bread cubes. Pour mixture into a 2-quart microwavable baking dish. Sprinkle with cinnamon-sugar. Cook uncovered 30 to 32 minutes at Power Level 7 or until knife inserted near center comes out clean. Let stand on a flat surface for 10 minutes. Serve warm.

Makes 12 servings.

1/2 cup butterscotch pieces
2 tablespoons butter or margarine
2½ cups miniature marshmallows
2½ cups crisp rice cereal

Butter Scotch Krispie Treats

1. Combine butterscotch pieces and butter in a 2-quart microwavable glass casserole. Cook uncovered 2 to 3 minutes at Power Level 7 or until melted. Stir in marshmallows. Cook uncovered 3 to 4½ minutes at Power Level 6 or until marshmallows are softened; stir twice. Blend until smooth.

2. Stir rice cereal into marshmallow mixture. Press into buttered 8×8×2-inch microwavable baking dish. Let stand until cool and set. Cut into squares.

Makes about 25 squares.

3/4 cup water
1 rounded teaspoon instant coffee granules
2 teaspoons sugar
2 tablespoons Irish whiskey
whipped cream

Irish Coffee

1. Combine water, instant coffee, and sugar in an 8-ounce microwavable coffee cup. Cook uncovered 1 to 1½ minutes at Power Level 10 or until hot.

2. Stir in whiskey and garnish with whipped cream.

Makes about 1 cup.

APPENDIX

REHEATING

To heat or reheat successfully in the microwave, it is important to follow several guidelines. Measure the amount of food in order to determine the time needed to reheat. Arrange the food in a circular pattern for best results. Room temperature food will heat faster than refrigerated food. Canned foods should be taken out of the can and placed in a microwavable container. The food will heat more evenly if covered with a microwavable lid or plastic wrap, vented. Remove cover carefully to prevent steam burns. Use the following chart as a guide for reheating cooked food.

Item	Power Level	Cook Time	Special Instructions
Sliced meat 3 slices (1/2-inch thick)	8	30 to 60 seconds	Place sliced meat on microwavable plate. Cover with plastic wrap and vent. • NOTE: Gravy or sauce helps to keep meat juicy.
Chicken pieces 1 breast 1 leg and thigh	8 8	1 1/2 to 2 minutes 1 to 1 1/2 minutes	Place chicken pieces on microwavable plate. Cover with plastic wrap and vent.
Fish fillet (6-8 oz.)	8	1 1/2 to 2 minutes	Place fish on microwavable plate. Cover with plastic wrap and vent.
Lasagna 1 serving (10 1/2 oz.)	8	3 1/2 to 4 1/2 minutes	Place lasagna on microwavable plate. Cover with plastic wrap and vent.
Casserole 1 cup 4 cups	8 8	1 to 1 1/2 minutes 5 to 5 1/2 minutes	Cook covered in microwavable casserole; stir once halfway through cooking.
Casserole cream or cheese 1 cup 4 cups	5 5	2 to 3 minutes 11 1/2 to 12 1/2 minutes	Cook covered in microwavable casserole; stir once halfway through cooking.
Sloppy joe or barbecued beef 1 sandwich (1/2 cup meat filling without bun)	9	45 to 60 seconds	Reheat filling and bun separately. Cook filling covered in microwavable casserole; stir once. Heat bun as directed in chart below.
Mashed potatoes 1 cup 4 cups	8 8	3 to 3 1/2 minutes 6 to 6 1/2 minutes	Cook covered in microwavable casserole; stir once halfway through cooking.
Baked beans 1 cup	9	2 to 2 1/2 minutes	Cook covered in microwavable casserole; stir once halfway through cooking.
Ravioli or pasta in sauce 1 cup 4 cups	9 9	2 to 3 minutes 7 to 8 minutes	Cook covered in microwavable casserole; stir once halfway through cooking.
Rice 1 cup 4 cups	9 9	1 to 1 1/2 minutes 3 1/2 to 4 minutes	Cook covered in microwavable casserole; stir once halfway through cooking.
Sandwich roll or bun 1 roll	8	10 to 15 seconds	Wrap in paper towel and place on roast rack.
Vegetables 1 cup 4 cups	9 9	1 to 1 1/2 minutes 5 1/2 to 6 1/2 minutes	Cook covered in microwavable casserole; stir once halfway through cooking.

WHIRLPOOL® Microwave Oven Warranty

MW002

LENGTH OF WARRANTY	WHIRLPOOL WILL PAY FOR
FULL ONE-YEAR WARRANTY From Date of Purchase	FSP® replacement parts and repair labor to correct defects in materials or workmanship. Service must be provided by an authorized Whirlpool SM service company.
LIMITED FOUR-YEAR WARRANTY Second Through Fifth Year From Date of Purchase	FSP® replacement magnetron tube on microwave ovens if defective in materials or workmanship.
WHIRLPOOL WILL NOT PAY FOR	
<p>A. Service calls to:</p> <ol style="list-style-type: none"> 1. Correct the installation of the microwave oven. 2. Instruct you how to use the microwave oven. 3. Replace house fuses or correct house wiring. 4. Replace owner accessible light bulbs. <p>B. Repairs when microwave oven is used in other than normal, single-family household use.</p> <p>C. Pick-up and delivery. This product is designed to be repaired in the home.</p> <p>D. Damage to microwave oven caused by accident, misuse, fire, flood, acts of God or use of products not approved by Whirlpool.</p> <p>E. Any labor costs during limited warranties.</p>	

WHIRLPOOL CORPORATION SHALL NOT BE LIABLE FOR INCIDENTAL OR CONSEQUENTIAL DAMAGES. Some states do not allow the exclusion or limitation of incidental or consequential damages so this limitation or exclusion may not apply to you. This warranty gives you specific legal rights, and you may also have other rights which vary from state to state.

Outside the United States, a different warranty may apply. For details, please contact your franchised Whirlpool distributor or military exchange.

If you need service, first see the "Service and Assistance" section of this book. After checking "Service and Assistance," additional help can be found by calling our COOL-LINE® service assistance telephone number, **1-800-253-1301**, from anywhere in the U.S.

® Registered Trademark/SM Service Mark of Whirlpool Corporation.