

KitchenAid[®]
PRO LINE™ SERIES

GUIDE TO
PROFESSIONAL
RESULTS

Model KPTT890 & KPTT780 Toasters



KitchenAid[®]
PRO LINE™ SERIES

MODEL
KPTT890
& **KPTT780**
TOASTERS

**Introduction
Section Contents**

Table of Contents	3
Toaster Safety	4
Important Safeguards	5
Proof of Purchase & Registration	6
Electrical Requirements	7

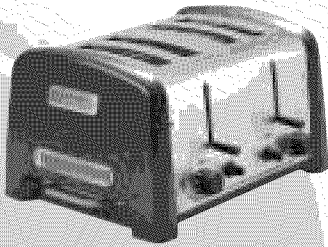

KitchenAid® PRO LINE™ Series Toasters

are engineered to be a near perfect blend of commercial durability, classic style, and contemporary performance for the home. We

began the design process by looking at the essence of toasting in the commercial kitchen – and quickly discovered that simplicity, dependability, and craftsmanship were the things most valued by the professionals. At that point, our goal became clear: we needed to build those essential qualities into a machine that offered a level of performance that couldn't be found anywhere else.

The result is the PRO LINE™ Series 2 and 4 slice toasters.

The stainless steel and die-cast metal construction will withstand the toughest kitchen environment – and look terrific doing so. A tone sounds when your toast is ready, but the toast will remain within the warm toasting cavity until you're ready to remove it. Nine shade levels provide toast for every taste, and a heat sensor and microprocessor ensure beautifully consistent results slice after slice. Dual controls on the 4-slice Toaster speeds preparation when toasting different breads or making toast for particular tastes.

The KitchenAid® PRO LINE™ Series: commercial quality for the discriminating home chef. From the company distinguished by its legendary craftsmanship.

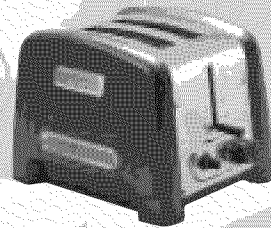

TABLE OF CONTENTS

INTRODUCTION

Introduction.....	2
Toaster Safety.....	4
Important Safeguards.....	5
Proof of Purchase & Product Registration.....	6
Electrical Requirements.....	7

FEATURES AND OPERATION

Toaster Features.....	10
Using the Toasters	
Before First Use.....	13
Dual Controls of the KPTT890.....	13
Toaster Operation.....	13
Checking the Toasting Progress.....	15
Canceling the Toasting Cycle.....	15
Toasting Tips.....	16
Using the Sandwich Rack & Bun Warmer Accessories.....	17
Care & Cleaning.....	19
Troubleshooting.....	20
Recipes for Flavored Butter.....	21

WARRANTY AND SERVICE INFORMATION

Warranty for the 50 United States & District of Columbia.....	26
Warranty for Puerto Rico.....	27
Arranging for Hassle-Free Replacement.....	28
Ordering Accessories & Replacement Parts.....	28
Arranging for Service After the Warranty Expires.....	29
Arranging for Service Outside the 50 United States & Puerto Rico.....	29

TOASTER SAFETY

Your safety and the safety of others are very important.

We have provided many important safety messages in this manual and on your appliance. Always read and obey all safety messages.



This is the safety alert symbol.

This symbol alerts you to potential hazards that can kill or hurt you and others.

All safety messages will follow the safety alert symbol and either the word “DANGER” or “WARNING.” These words mean:

! DANGER

You can be killed or seriously injured if you don't immediately follow instructions.

! WARNING

You can be killed or seriously injured if you don't follow instructions.

All safety messages will tell you what the potential hazard is, tell you how to reduce the chance of injury, and tell you what can happen if the instructions are not followed.

IMPORTANT SAFEGUARDS

When using electrical appliances, basic safety precautions should always be followed, including the following:

1. Read all instructions.
2. Do not touch hot surfaces. Use handles or knobs.
3. To protect against electrical shock, do not immerse cord, plugs, or Toaster in water or other liquids.
4. Close supervision is necessary when any appliance is used by or near children.
5. Unplug Toaster from outlet when not in use and before cleaning. Allow to cool before putting on or taking off parts.
6. Do not operate any appliance with a damaged cord or plug, or after the appliance malfunctions or has been damaged in any manner. Return appliance to the nearest authorized service facility for examination, repair, or adjustment.
7. The use of accessory attachments not recommended by the appliance manufacturer may cause injuries.
8. Do not use outdoors.
9. Do not let cord hang over edge of table or counter, or touch hot surfaces.
10. Do not place on or near a hot gas or electric burner, or in a heated oven.
11. To disconnect, turn any control to "Off", then remove plug from outlet.
12. Do not use appliance for other than intended use.
13. Oversize foods, metal foil packages, or utensils must not be inserted in Toaster as they may involve a risk of fire or electric shock.
14. A fire may occur if Toaster is covered or touching flammable material, including curtains, draperies, walls and the like, when in operation.
15. Do not attempt to dislodge food when Toaster is plugged in.
16. This product has been UL Listed for household and commercial use.

SAVE THESE INSTRUCTIONS

PROOF OF PURCHASE & PRODUCT REGISTRATION

Always keep a copy of the sales receipt showing the date of purchase of your Toaster. Proof of purchase will assure you of in-warranty service.

Before you use your Toaster, please fill out and mail your product registration card packed with the unit. This card will enable us to contact you in the unlikely event of a product safety notification and assist us in complying with the provisions of the Consumer Product Safety Act. This card does not verify your warranty.

Please complete the following for your personal records:

Model Number: 2-Slice Toaster – KPTT780

4-Slice Toaster – KPTT890

Serial Number _____

Date Purchased _____

Store Name _____

ELECTRICAL REQUIREMENTS

Volts: 120 V.A.C. only.

Hertz: 60 Hz

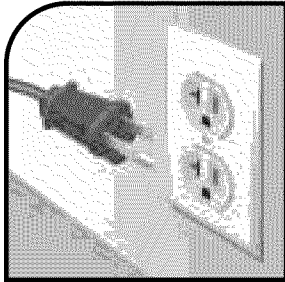

NOTE: This Toaster has a 3 prong grounded plug. To reduce the risk of electrical shock, this plug will fit in an outlet only one way. If the plug does not fit in the outlet, contact a qualified electrician. Do not modify the plug in any way.

Do not use an extension cord. If the power supply cord is too short, have a qualified electrician or serviceman install an outlet near the appliance.

⚠ WARNING

Electrical Shock Hazard Plug into a grounded 3 prong outlet.
Do not remove ground prong.
Do not use an adapter.
Do not use an extension cord.
Failure to follow these instructions can result in death, fire, or electrical shock.



KitchenAid®
PRO LINE™ SERIES

FEATURES AND OPERATION

Features and Operation Section Contents

Toaster Features.....	10
Using the Toasters	
Before First Use.....	13
Dual Controls (Model KPTT890).....	13
Toaster Operation.....	13
Checking the Toasting Progress.....	15
Canceling the Toasting Cycle.....	15
Toasting Tips.....	16
Toaster Accessories.....	17
Care & Cleaning.....	19
Troubleshooting.....	20
Flavored Butter Recipes.....	21

MODEL KPTT890 & KPTT780

TOASTER FEATURES

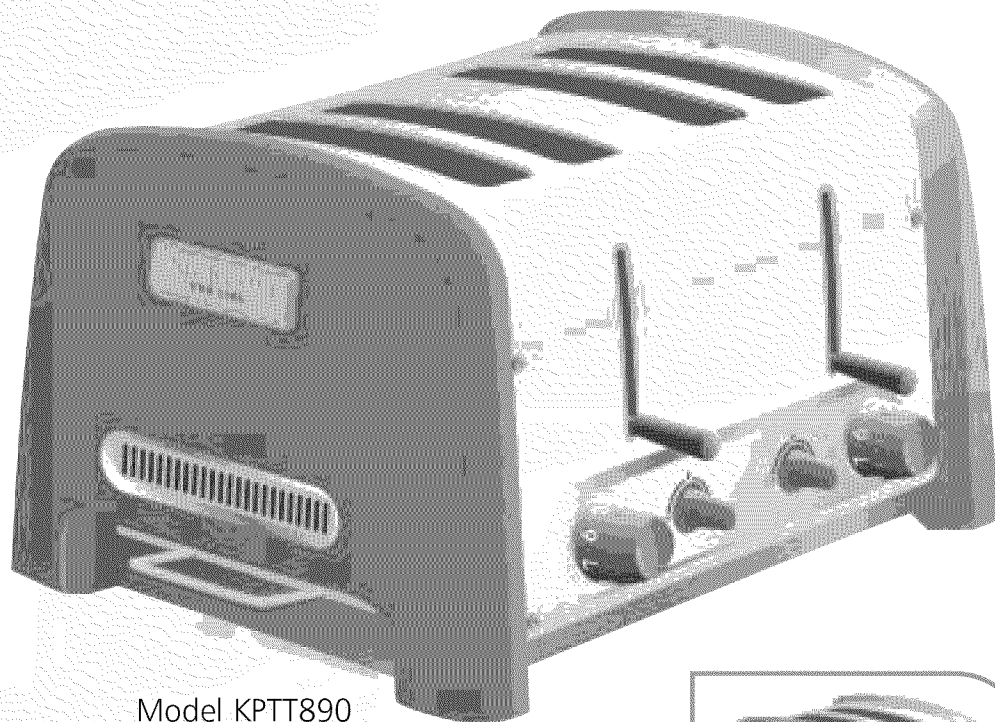

Model KPTT890
4-slice Toaster

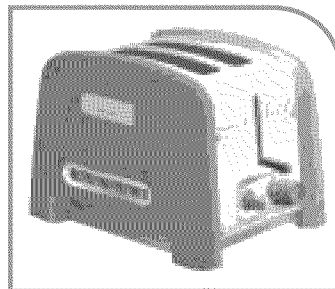

Model KPTT780
2-slice Toaster

Stainless Steel and Die-Cast Metal Construction

Designed to withstand the commercial environment, the rugged metal construction will last for years.

Outstanding Performance

Heavy gauge heating elements held flat on extra-thick mica boards ensure even browning. A heat sensor and microprocessor yield consistent toasting slice after slice, without pre-heating.

Flexible Operation

On the 4-slice KPTT890, each pair of slots features its own shade dial, lift lever, and on/off switch. Speeds preparation when making toast for different tastes.

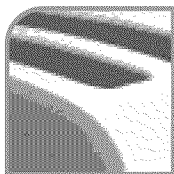

Wide, Deep Slots

1" wide slots handle bagels, English muffins, thick breads, and toaster pastries easily.

Extra-deep toasting cavity enhances even browning.

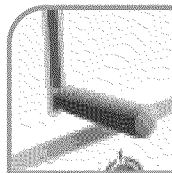

Stay Warm™ Feature

After toasting is complete, bread remains in the warm toasting cavity until it is raised

manually. Raising the lift lever doesn't cancel a toasting cycle, so the toasting progress can be checked anytime. Lift levers are motion-damped for smooth operation.

True Vertical Lift

Lift lever raises bread vertically, not in an arc – so specialty breads are less likely to tear or jam in slots.

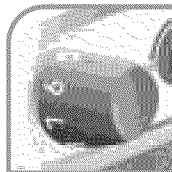

Shade Dial

9 shade levels provide consistent browning for every taste.

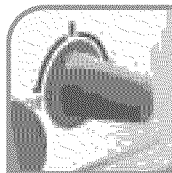

On/Off Switch

Turn switch momentarily to "On" to start toasting, or to "Off" to stop a toasting cycle.

Continued...

MODEL KPTT890 & KPTT780 TOASTER FEATURES

Function Light

Indicates when toaster is operating.

Toasting Finished Tone

Tone sounds when a toasting cycle is complete.

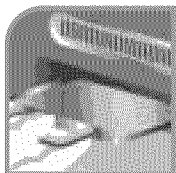

Removable Crumb Tray

Full-width, polished stainless steel tray is dishwasher-safe. Model

KPTT890 has two trays, one for each pair of slots.

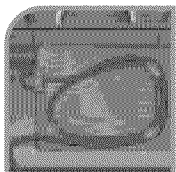

Under Base Cord Wrap

Keeps extra cord out of sight and out of the way.

Overtemp Protection

Toasting cycle is electronically controlled. Toaster will not remain on and overheat due to a mechanical jam or failure.

USING THE PRO LINE™ SERIES TOASTERS

MODEL KPTT890 & KPTT780

Before First Use:

Before using your toaster, check the slots and remove any packing or printed material that may have fallen inside during shipping or handling.

The toaster may emit a pungent odor or light smoke the first time you use it. This is a normal result of the manufacturing process. The odor or smoke is harmless and will dissipate quickly.

Dual Controls of the KPTT890:

The 4-slice KPTT890 toaster has separate controls for each pair of toasting slots, so you can prepare toast for different tastes – or toast different breads – simultaneously. Follow the same operating steps regardless of which slot pair you are using.

Toaster Operation:

1. Shorten the cord, if necessary, by wrapping it under the base.

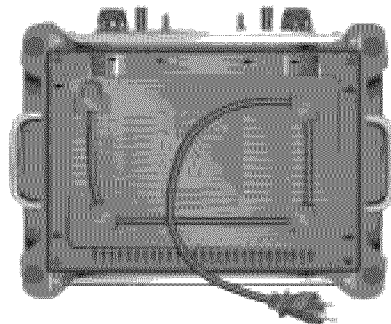

Model KPTT890
4-slice Toaster

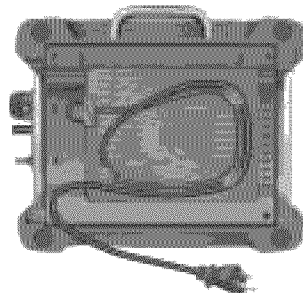

Model KPTT780
2-slice Toaster

Continued...

USING THE PRO LINE™ SERIES TOASTERS

MODEL KPTT890 & KPTT780

! WARNING



Electrical Shock Hazard
Plug into a grounded 3 prong outlet.
Do not remove ground prong.
Do not use an adapter.
Do not use an extension cord.
Failure to follow these instructions can result in death, fire, or electrical shock.

2. Plug toaster cord into a grounded 3 prong electrical outlet. A tone will sound when the toaster is connected.
3. Insert bread or other food to be toasted into the slots. If you have only 1 or 2 slices to toast, it makes no difference which pair of slots, or individual slot, you use.

4. Turn the Shade Dial to select the degree of darkness you want. Rotate the Shade Dial clockwise for darker toast, counter-clockwise for lighter. Shade settings 1-3 are light, 4-6 are medium, and 7-9 are dark.
5. Push the lift lever down until the bread is lowered as far as possible, then turn the On/Off Switch momentarily to the "On" position. The switch will spring back to the middle position and the function light will glow, indicating the toasting cycle has started.

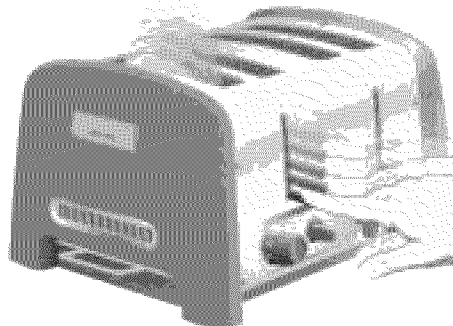

NOTE: Toaster will automatically shut off if the On/Off Switch is held in the “On” position more than 15 seconds.

6. When the toasting cycle is complete, a tone will sound and the function light will stop glowing. The toast will remain in the warm toasting cavity until the lift lever is raised.

To Check Toasting Progress:

To check the progress of your toast during a toasting cycle, raise the manual lift lever. Raising the lift lever will not cancel the toasting cycle, enabling you to simply lower the bread if additional browning is required. If you remove the bread before a toasting cycle is complete, don't forget to cancel the cycle by turning the On/Off Switch momentarily to the “Off” position. If you forget to cancel the cycle, the toaster will automatically shut off at the end of the cycle time.

NOTE: Operating the toaster without bread will not harm the toaster.

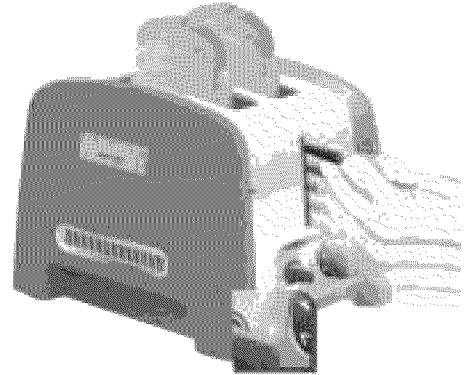

To Cancel Toasting Cycle:

To cancel the toasting cycle at anytime, turn the On/Off Switch momentarily to the “Off” position. The function light will stop glowing and the toasting cycle will end.

TOASTING TIPS

1

Different types of bread and their moisture levels may require different shade settings. For example, dry bread will brown more rapidly than moist bread and will require a lighter setting. Bagels and English muffins usually require higher shade settings due to their firm texture and high density.

2

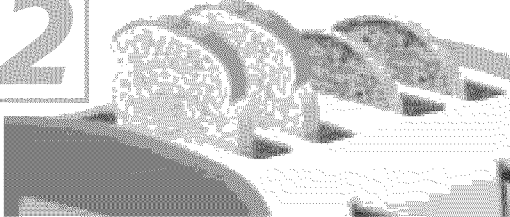

For best results, toast only one bread type and thickness at a time in a given pair of toasting slots.

USING THE OPTIONAL SANDWICH RACK & BUN WARMER ACCESSORIES

Sandwich Rack

Model KTSR

The sandwich rack is the perfect way to toast sandwiches quickly and easily.

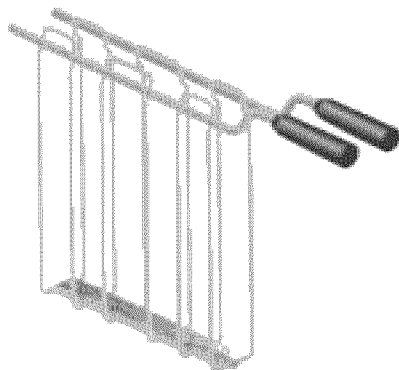

To use:

1. Open the rack by spreading the handles apart.
2. Place one edge of the sandwich against the bottom channel of the rack.
3. Press the sandwich rack handles together to grip the sandwich.

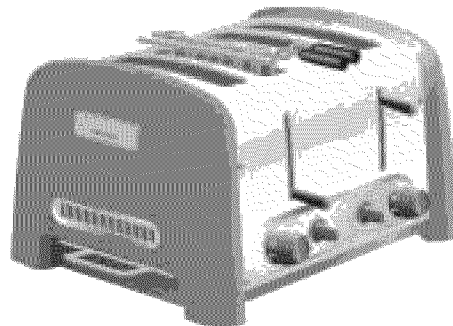

4. Lower the toaster lift lever as far as possible and insert the sandwich rack into the slot.
5. Select a shade level and turn the On/Off Switch momentarily to the "On" position to begin toasting.
6. Remove sandwich rack when toasting is complete. Remember: the rack will be hot immediately following a toasting cycle.
7. Remove the sandwich from the rack. You may want to use a spatula or tongs when doing so.

Continued...

USING THE OPTIONAL SANDWICH RACK & BUN WARMER ACCESSORIES

Sandwich Toasting Tips

- Do not overfill the sandwich. Thinly sliced ingredients – like ham, turkey, and cheese – work best.
- Lightly butter the outside of the sandwich bread – do not butter the side which faces the filling. Buttering the outside of the bread slows browning and helps warm the filling.

Bun Warmer

Model KTBW2 – 2-slice

Model KTBW4 – 4-slice

Conveniently warm buns on the top of your toaster with the bun warmer accessory.

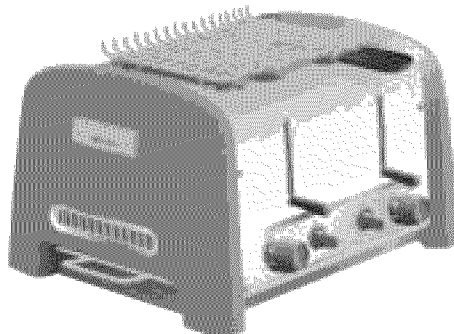
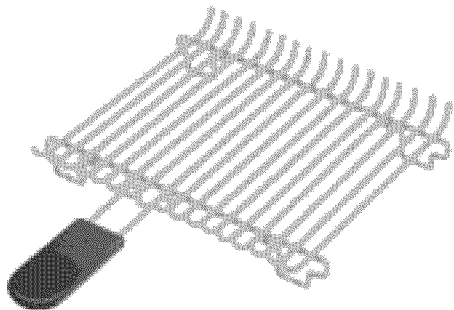

To use:

1. Lower the toaster lift lever or levers as far as possible. Place bun warmer on top of the toaster, making sure the formed wire loops on the bottom of the warmer fit into the toaster slots.
2. Place buns on top of the warmer, select a shade level, and turn the On/Off Switch momentarily to the "On" position to begin warming. Remember: the bun warmer will be hot immediately following a toasting cycle.

CARE AND CLEANING

1 Always unplug the toaster and let it cool before cleaning.

2 Slide out the crumb tray (the KPTT890 has two trays, one for each pair of slots) and shake the crumbs into a waste container. It is recommended that the crumb tray be emptied after each use. Remember: the tray will be hot immediately following a toasting cycle.

NOTE: Lifting the crumb tray handle locks the crumb tray inside the toaster, preventing removal. Always pull the crumb tray straight from the toaster without lifting the handle.

The crumb tray can be washed in the top rack of a dishwasher, or by hand in warm soapy water. If hand washing, be sure to rinse the tray and dry it thoroughly with a soft cloth.

Be sure to insert the crumb tray into the toaster as far as possible. For best toasting results, do not use the toaster without the crumb tray in its proper position.

3 The optional sandwich rack and bun warmer accessories can be washed in the top rack of a dishwasher, or by hand in warm soapy water. If hand washing, be sure to rinse the accessory and dry it thoroughly with a soft cloth.

4 Wipe the toaster with a soft, damp cotton cloth. Do not use abrasive cleansers, scrubbers, or liquid cleaning products. Do not immerse the toaster in water.

5 KitchenAid does not recommend the use of a toaster cover.

TROUBLESHOOTING

The toaster may emit a pungent odor or light smoke the first time you use it. This is a normal result of the manufacturing process. The odor or smoke is harmless and will dissipate quickly.

- **If the function light remains dark and the toaster fails to heat when the On/Off Switch is turned to “On”:**

Check to see if the toaster is plugged in; if it is, unplug the toaster, then plug it back in again. A tone will sound when the toaster is plugged into a live electrical outlet. If no tone sounds, check the electrical circuit the toaster is connected to – is a fuse blown or a circuit-breaker tripped in your home? If the problem cannot be corrected, see the KitchenAid Warranty and Service section on page 25 for service information.*

- **If you have difficulty removing the crumb tray:**

Lifting the crumb tray handle locks the crumb tray inside the toaster, preventing removal. Always pull the crumb tray straight from the toaster without lifting the handle.

- **If the function light next to the On/Off Switch flashes:**

A flashing function light signals a fault in the toaster electronics. Unplug the toaster and refer to the KitchenAid Warranty and Service section on page 25 for service information.*

* Do not return the Toaster to the retailer – they do not provide service.

RECIPES FOR FLAVORED BUTTER

HONEY-ORANGE BUTTER

Add all ingredients to food processor. Process until thoroughly mixed, about 30 seconds.

Yield: $\frac{1}{2}$ cup (16 $\frac{1}{2}$ -tablespoon servings).

Per serving: About 56 cal, 0 g pro, 1 g carb, 6 g fat, 16 mg chol, 38 mg sod.

$\frac{1}{2}$ cup very soft butter,
margarine, or
reduced-calorie
margarine

2 tablespoons orange
juice concentrate,
thawed

1 tablespoon honey

$\frac{1}{2}$ teaspoon cinnamon

RECIPES FOR **FLAVORED BUTTER**

*½ cup very soft butter,
margarine, or
reduced-calorie
margarine*

*1 tablespoon fresh
thyme leaves
(stripped from stem)*

*4 teaspoons
lemon juice*

LEMON-THYME BUTTER

Add all ingredients to food processor. Process until thoroughly mixed, about 30 seconds.

Yield: ½ cup (16½-tablespoon servings).

Per serving: About 51 cal, 0 g pro, 0 g carb,
6 g fat, 16 mg chol, 39 mg sod.

RECIPES FOR FLAVORED BUTTER

CHEESY GARLIC BUTTER

With food processor running, add garlic through feed tube. Process until coarsely chopped, about 5 seconds. Add remaining ingredients. Process until well mixed, about 30 seconds.

Yield: ½ cup (16½-tablespoon servings).

Per serving: About 58 cal, 1 g pro, 0 g carb, 6 g fat, 17 mg chol, 67 mg sod.

- 1 clove garlic
- ½ cup very soft butter, margarine, or reduced-calorie margarine
- ¼ cup freshly grated Parmesan cheese



KitchenAid[®]
PRO LINE™ SERIES

**WARRANTY
AND SERVICE
INFORMATION**

**Warranty Information
Section Contents**

Warranty for the U.S.	26
Warranty for Puerto Rico	27
Arranging for Hassle-Free Replacement	28
Ordering Accessories and Replacement Parts	28
Arranging for Service After the Warranty Expires	29
Arranging for Service Outside the U.S. & Puerto Rico	29

TOASTER **WARRANTY** FOR THE **50 UNITED STATES** AND DISTRICT OF COLUMBIA

This warranty extends to the purchaser and any succeeding owner for PRO LINE™ Series Toasters operated in the 50 United States and District of Columbia.

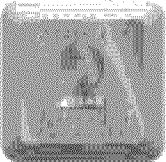
Length of Warranty:	KitchenAid Will Pay For Your Choice of:	KitchenAid Will Not Pay For:
<p>Two Year Full Warranty for Household Use, from date of purchase.</p>	<div style="display: flex; align-items: center;">  <p>Hassle-Free Replacement of your Toaster. See "Arranging for Hassle-Free Replacement" for details, or call the Customer Satisfaction Center toll-free at 1-800-541-6390.</p> <p>OR</p> <p>The replacement parts and repair labor costs to correct defects in materials and workmanship. Service must be provided by an Authorized KitchenAid Service Center. See the KitchenAid® PRO LINE™ Series Toaster Warranty for Puerto Rico for details on how to arrange for service.</p> </div>	<ul style="list-style-type: none"> A. Repairs when Toaster is used in other than normal single family home use. B. Damage resulting from accident, alteration, misuse or abuse. C. Any shipping or handling costs to deliver your Toaster to an Authorized Service Center. D. Replacement parts or repair labor costs for Toasters operated outside the United States and District of Columbia.

KITCHENAID DOES NOT ASSUME ANY RESPONSIBILITY FOR INCIDENTAL OR CONSEQUENTIAL DAMAGES. Some states do not allow the exclusion or limitation of incidental or consequential damages, so this exclusion may not apply to you. This warranty gives you specific legal rights and you may also have other rights which vary from state to state.

TOASTER **WARRANTY** FOR **PUERTO RICO**

A limited two year warranty extends to the purchaser and any succeeding owner for PRO LINE™ Series Toasters operated in Puerto Rico. During the warranty period, all service must be handled by an Authorized KitchenAid Service Center.

Please bring the Toaster, or ship it prepaid and insured, to the nearest Authorized Service Center. Simply call toll-free **1-800-541-6390** Monday through Friday, 8 a.m. to 8 p.m. (Eastern Time), or Saturday, 10 a.m. to 5 p.m. to learn the location of a Service Center near you. Your repaired Toaster will be returned to you prepaid and insured.

ARRANGING FOR **HASSLE-FREE** REPLACEMENT

IF YOU RESIDE IN THE 50 UNITED STATES and your KitchenAid® PRO LINE™ Series Toaster should fail within two years of ownership, simply call our toll-free Customer Satisfaction Center at **1-800-541-6390** Monday through Friday, 8 a.m. to 8 p.m. (Eastern Time), or Saturday, 10 a.m. to 5 p.m. Give the consultant your complete shipping address. (No P.O. Box Numbers, please.)

KitchenAid will arrange to deliver an identical or comparable replacement to your door free of charge and arrange to have your “failed” Toaster returned to us. Your replacement unit will also be covered by our two year full warranty.

When you receive your replacement PRO LINE™ Series Toaster, use the carton and packing materials to pack-up your “failed” Toaster. In the carton, include your name and address on a sheet of paper along with a copy of the proof of purchase (register receipt, credit card charge slip, etc.).

ORDERING **ACCESSORIES** AND **REPLACEMENT** PARTS

To order accessories or replacement parts for your Toaster, call toll-free **1-800-541-6390** Monday through Friday, 8 a.m. to 8 p.m. (Eastern Time), or Saturday, 10 a.m. to 5 p.m. or write to: Customer Satisfaction Center, KitchenAid Portable Appliances, P.O. Box 218, St. Joseph, MI 49085-0218.

ARRANGING FOR **SERVICE** AFTER THE **WARRANTY** EXPIRES

For service information, call toll-free **1-800-541-6390** Monday through Friday, 8 a.m. to 8 p.m. (Eastern Time), or Saturday, 10 a.m. to 5 p.m. or write to: Customer Satisfaction Center, KitchenAid Portable Appliances, P.O. Box 218, St. Joseph, MI 49085-0218.

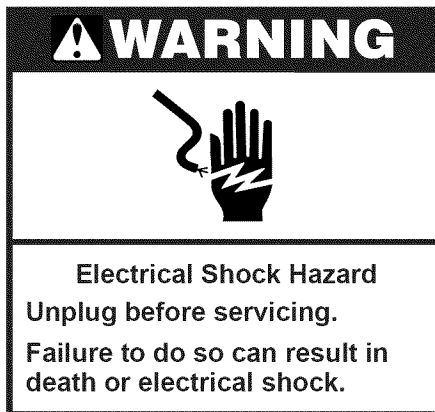

ARRANGING FOR **SERVICE** OUTSIDE THE **50 UNITED STATES** AND PUERTO RICO

Consult your local KitchenAid dealer or the store where you purchased your PRO LINE™ Series Toaster for information on how to obtain service.

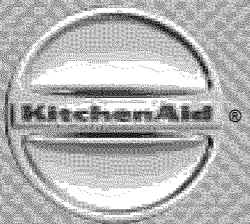

FOR THE WAY IT'S MADE.™

® Registered Trademark/™ Trademark of KitchenAid, U.S.A.
© 2003. All rights reserved.

Specifications subject to change without notice.

dZw1203

