

Use and Care Guide

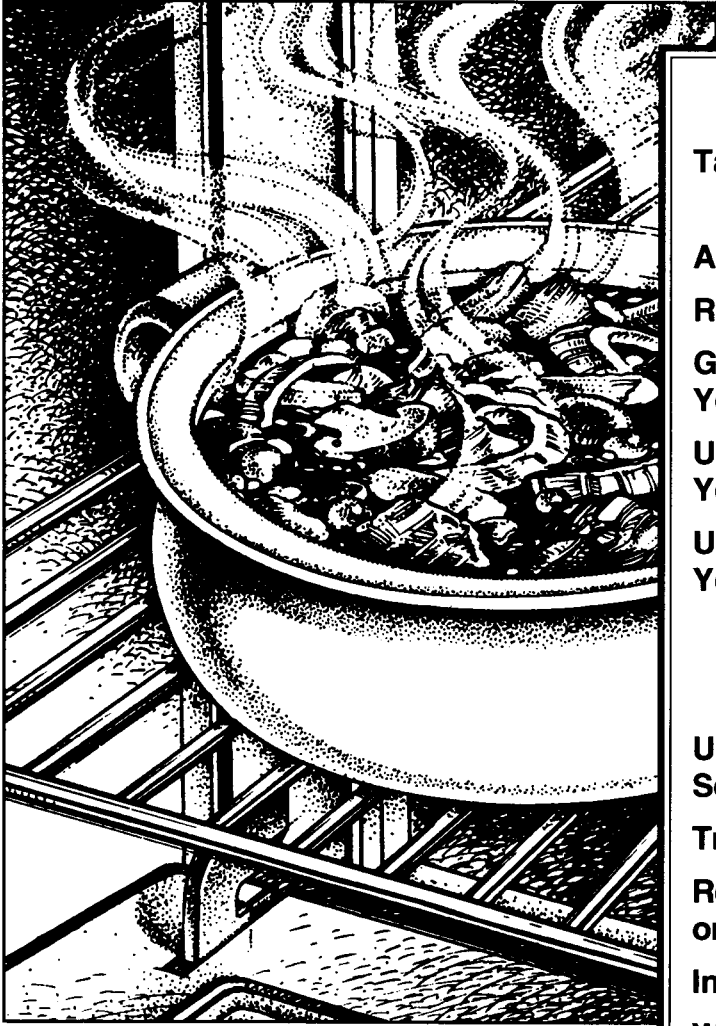

KitchenAid®

Table of Contents (complete)	2
A Note to You	3
Range Safety	4-6
Getting to Know Your Range	7
Using and Caring for Your Cooktop	11
Using and Caring for Your Oven	18
Using EASY CONVECT* Conversion	36
Using the Self-Cleaning Cycle ...	51
Troubleshooting	55
Requesting Assistance or Service	57
Index	62
Warranty	64

In the U.S.A. for assistance or service,
call the Consumer Assistance Center:

1-800-422-1230

In Canada for assistance or service,
see page 58.

KITCHENAID® THERMAL-CONVECTION® Electric Ranges

Models: KESC307 KESH307 KERC607
YKESC307 YKESH307 YKERC607

Table of Contents

A Note to You	3	Using the temperature probe	31
Range Safety	4-6	Using Convect Full Meal	33
Getting to Know Your Range	7	Using EASY CONVECT*	
Feature locations	7	Conversion	36
The oven vent	9	Broiling	38
The storage drawer	9	Convection broiling	40
The anti-tip bracket	10	Timed cooking	43
Using and Caring for Your Cooktop	11	Dehydrating	46
Using the surface units	11	Raising (proofing) bread	47
Cookware tips	13	Cleaning your oven and controls	48
Caring for your cooktop	14	Using and replacing the oven light(s) ...	50
Using and replacing the surface light ...	16	Using the Self-Cleaning Cycle	51
Using and Caring for Your Oven	18	Before you start	51
Using the electronic oven control	18	Before setting the controls	52
Oven settings	21	Setting the controls	52
Setting the clock	22	For best cleaning results	54
Using the timer	22	How the cycle works	54
Baking or convection baking	24	Troubleshooting	55
Roasting	25	Requesting Assistance or Service	57
Cooking tips	27	Index	62
Adjusting oven temperature	30	Warranty	64

A Note to You

Thank you for buying a KITCHENAID* appliance!

KitchenAid designs the best tools for the most important room in your house. To ensure that you enjoy many years of trouble-free operation, we developed this Use and Care Guide. It contains valuable information concerning how to operate and maintain your new appliance properly and safely. Please read it carefully.

Also, please complete and mail the enclosed Product Registration Card.

If you need assistance or service, first see the "Troubleshooting" section of this book. After checking "Troubleshooting," additional help can be found by checking the "Requesting Assistance or Service" section.

When calling, you will need to know your appliance's complete model number and serial number. You can find this information on the model and serial number plate (see diagrams on pages 7 or 8).

Keep this book and the sales slip together in a safe place for future reference. **You must provide proof of purchase or installation date for in-warranty service.**

Model Number _____

Builder/Dealer Name _____

Serial Number _____

Address _____

Date Installed _____

Phone _____

Range Safety

IMPORTANT SAFETY INSTRUCTIONS

Your safety is important to us.

This guide contains safety symbols and statements. Please pay special attention to these symbols and follow any instructions given. Here is a brief explanation of the use of the symbol.



This symbol alerts you to hazards such as fire, electrical shock, or other injuries.

! WARNING

To reduce the risk of fire, electrical shock, injury to persons, or damage when using the range, follow basic precautions, including the following:

General

- Read all instructions before using the range.
- Install or locate the range only in accordance with the provided Installation Instructions. The range must be installed by a qualified installer. The range must be properly connected to electrical supply and grounded.



- **WARNING:** To reduce the risk of tipping the appliance, the appliance must be secured by a properly installed anti-tip bracket. To check if the bracket is installed properly, see "The anti-tip bracket" on page 10.
- **CAUTION:** Do not store things children might want above the range. Children could be burned or injured while climbing on it.
- Do not leave children alone or unattended in area where the range is in use. They should never be allowed to sit or stand on any part of the range. They could be burned or injured.

- Do not use the range for warming or heating the room. Persons could be burned or injured, or a fire could start.
- Use the range only for its intended use as described in this manual.



- Do not touch surface units, areas near units, heating elements, or interior surfaces of oven. Surface units and heating elements may be hot even though they are dark in color. Areas near surface units and interior surfaces of an oven become hot enough to cause burns. During and after use, do not touch, or let clothing or other flammable materials contact surface units, areas near units, heating elements, or interior surfaces of oven until they have had sufficient time to cool. Other surfaces of the range, such as the oven vent opening, the surface near the vent opening, the cooktop, and the oven door and window, could also become hot enough to cause burns.



- Do not operate the range if it is damaged or not working properly.



- Do not wear loose or hanging garments when using the range. They could ignite if they touch a hot surface unit and you could be burned.
- Use only dry pot holders. Moist or damp pot holders on hot surfaces could result in burns from steam. Do not let pot holder touch hot heating elements. Do not use a towel or bulky cloth for a pot holder. It could catch on fire.
- Keep range vents unobstructed.
- Do not heat unopened containers. They could explode. The hot contents could cause burns and container particles could cause injury.
- Use only cookware approved for oven use. Follow cookware manufacturer's instructions, especially when using glass or plastic cookware.
- Do not store flammable materials on or near the range. The fumes could create an explosion and/or fire hazard.
- Do not repair or replace any part of the range unless specifically recommended in this manual. All other servicing should be referred to a qualified technician.
- Disconnect the electrical supply before servicing the range.

When using the cooktop

- Do not cook on a broken ceramic glass cooktop. If cooktop should break, cleaning solutions and spillovers could penetrate the broken cooktop and create a risk of electrical shock. Contact a qualified technician immediately.
- Select a pan with a flat bottom that is about the same size as the surface unit. If pan is smaller than the surface unit, some of the heating element will be exposed and could result in the igniting of clothing or pot holders. Correct pan size also improves cooking efficiency.
- Check to be sure glass cookware is safe for use on the range. Only certain types of glass, glass-ceramic, ceramic, earthenware, or other glazed cookware are suitable for cooktops without breaking due to the sudden change in temperature.
- Never leave surface units unattended at high heat settings. A boilover could result and cause smoking and greasy spillovers that could ignite.



- Turn pan handles inward, but not over other surface units. This will help reduce the chance of burns, igniting of flammable materials, and spills due to bumping of the pan.

continued on next page

Range Safety

- Grease is flammable. Do not allow grease to collect around cooktop or in vents. Wipe spills over immediately.



- Do not use water on grease fires. Never pick up a flaming pan. Smother flaming pan on range by covering with a well-fitting lid, cookie sheet, or flat tray. Flaming grease outside of pan can be extinguished with baking soda or, if available, a multipurpose dry chemical or foam-type extinguisher.
- Clean ceramic glass cooktop with care. Some cleaners could produce noxious fumes if applied to a hot surface. If a wet paper towel is used to wipe spills on a hot cooking area, be careful to avoid steam burns.

When using the oven

- Always position oven rack(s) in desired location while oven is cool. If a rack must be removed while oven is hot, do not let pot holder contact hot heating elements in oven.
- Use care when opening oven door. Let hot air or steam escape before removing or replacing food.

- Small amounts of formaldehyde and carbon monoxide are given off in the Self-Cleaning cycle from fiberglass insulation and food decomposition. Significant exposure to these substances could cause cancer or reproductive harm. Exposure can be minimized by venting with a hood or open window and wiping out excess food spills prior to self-cleaning.

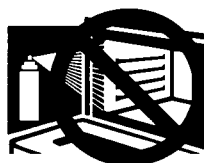

- Do not use oven cleaners. No commercial oven cleaner or oven liner protective coating of any kind should be used in or around any part of the oven.
- Before self-cleaning the oven, remove broiler pan, broiler grid, oven racks, and other cookware. Do not use your oven to clean miscellaneous parts unless you are instructed to do so in this Use and Care Guide.
- Do not clean door gasket. It is essential for a good seal. Care should be taken not to rub, damage, or move the gasket. Clean only parts recommended in this Use and Care Guide.

– SAVE THESE INSTRUCTIONS –

Getting to Know Your Range

This section tells you what features your range has and where they are located. It also discusses some convenience features that you should know about, but which are not needed to operate the range. Please review this information before using your range. To help you find information on specific parts or features quickly, page references are included.

Feature locations

(Slide-in models)

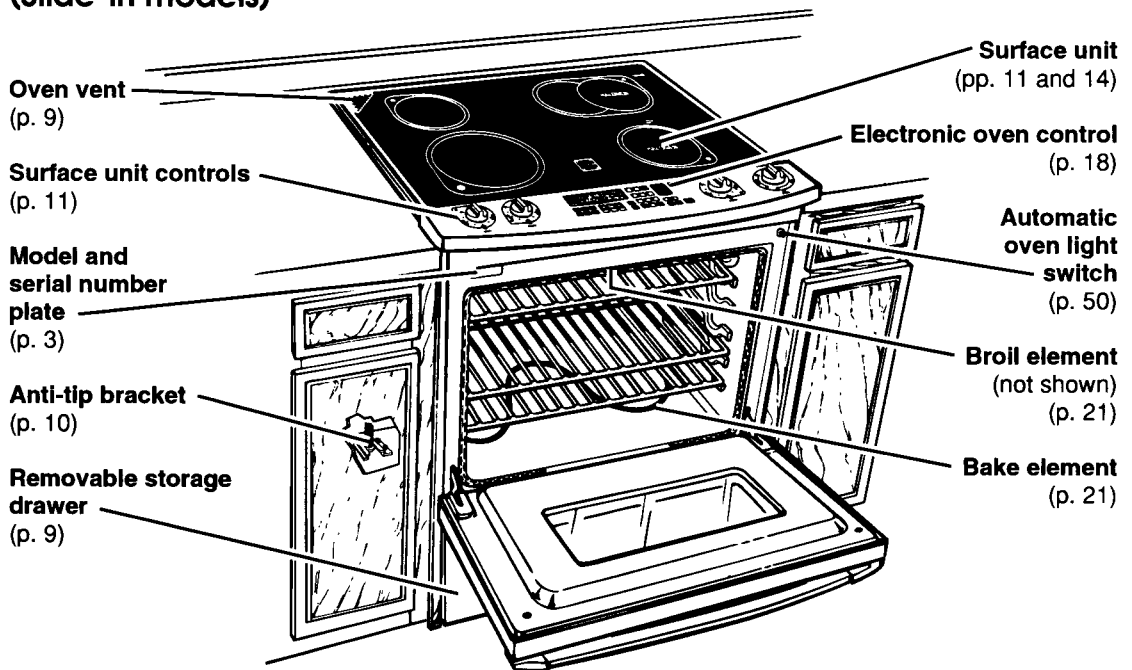

Surface unit controls

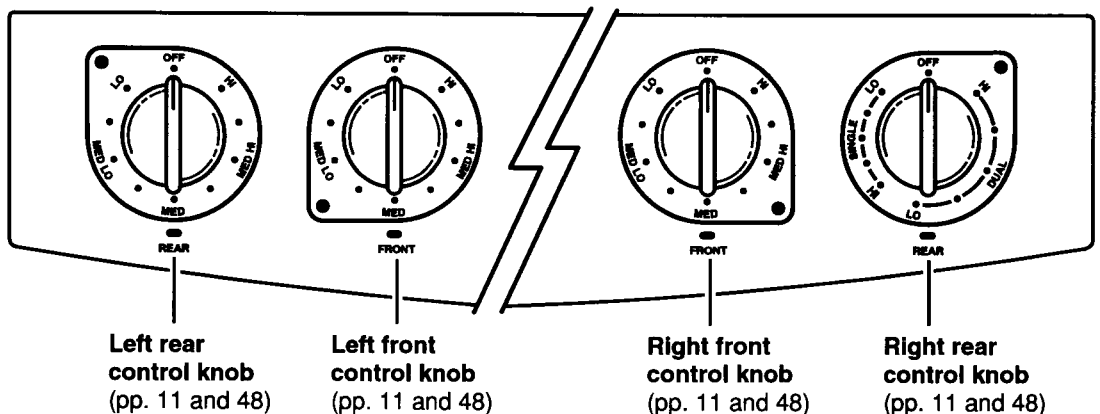



Getting to Know Your Range

(Freestanding models)

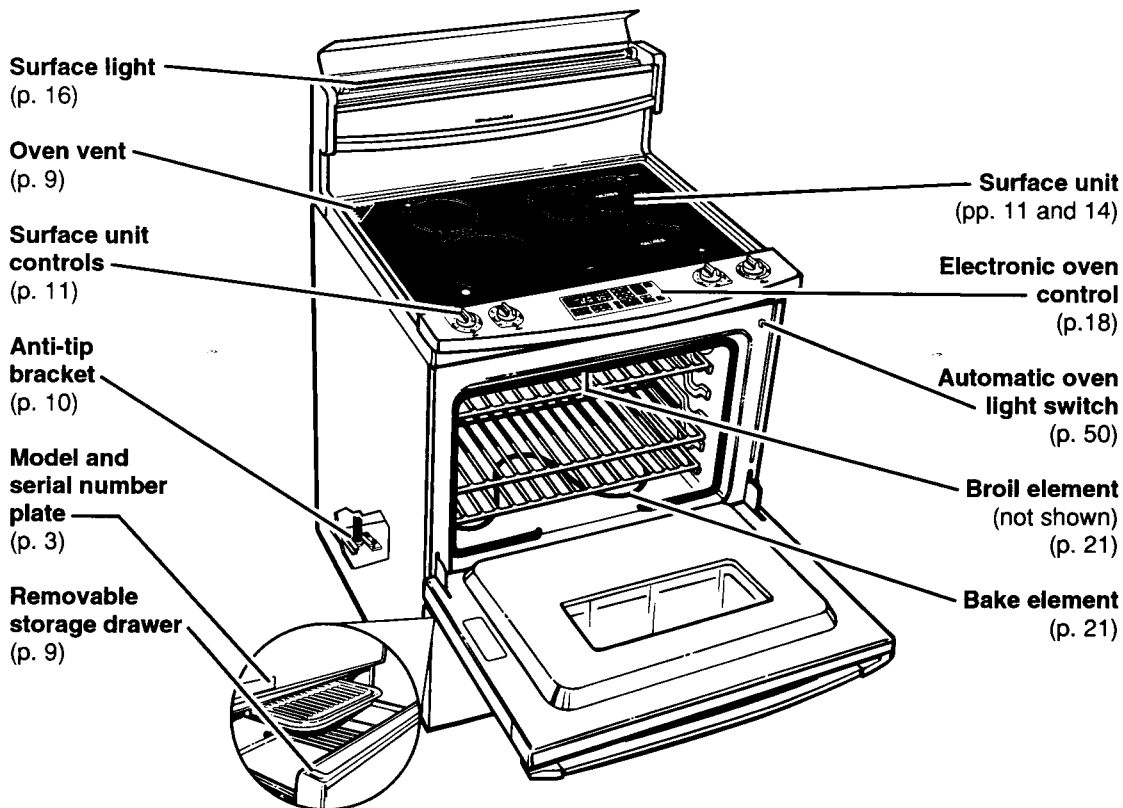

Surface unit controls

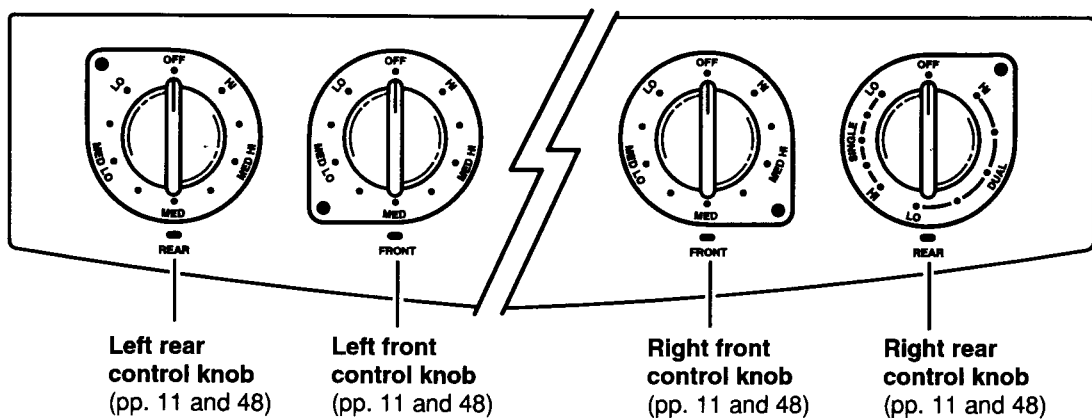



The oven vent

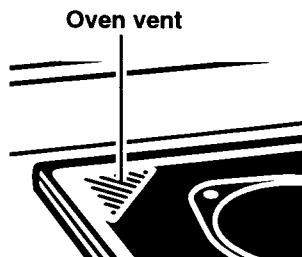

Hot air and moisture escape from the oven through a vent in the left rear corner of the cooktop. **Do not block the vent by using large pans or covers.** Poor baking/roasting can result.

NOTE: Plastic utensils left over the vent can melt.

⚠ WARNING



Burn Hazard

Use pot holders when touching items left near oven vent.

Failure to do so can result in burns.

The storage drawer

You can remove the storage drawer to make it easier to clean under the range and to check for installation of the anti-tip bracket. **Use care when handling the drawer.**

Removing the storage drawer:

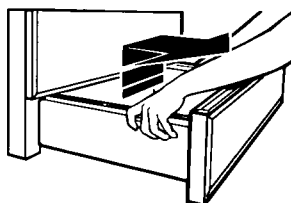

1. **Empty** drawer of any pots and pans before removing drawer. **Use** recessed area on top edge of drawer to pull drawer straight out to the first stop. **Lift** front and **pull out** to the second stop.
2. **Lift** back slightly and **slide** drawer all the way out.

Replacing the storage drawer:

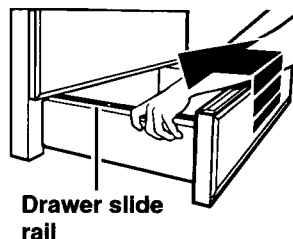

1. **Fit** ends of drawer slide rails into the drawer guides on both sides of opening.
2. **Lift** drawer front and **press in** until metal stops on drawer slide rails clear white stops on drawer guides. **Lift** drawer front again to clear second stop and **slide** drawer closed.

The anti-tip bracket

The range will not tip during normal use. However, tipping can occur if you apply too much force or weight to the open door without the anti-tip bracket properly secured.

! WARNING

Tip Over Hazard

- Connect anti-tip bracket to the range.
- Reconnect anti-tip bracket, if the range is moved.
- Do not push down on the open oven door.
- Follow the Installation Instructions.
- Do not let children climb onto the oven door.
- Failure to follow these instructions can result in death, burns, or other injury.



To verify the anti-tip bracket is engaged:

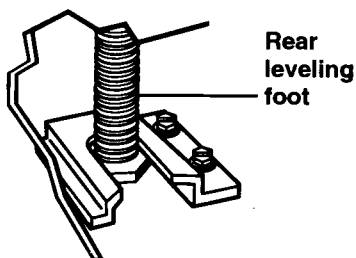

- **Remove** the storage drawer. (See page 9.)
- **Look** to see if the anti-tip bracket is attached to floor with screws.
- **Make sure** left rear leveling foot is positioned under the anti-tip bracket.
- **See** Installation Instructions for further details.

Using and Caring for Your Cooktop

This section tells you how to operate the controls to the cooktop. It also discusses how the ceramic glass cooktop works, and includes tips on how to cook with and maintain the cooktop.

Using the surface units

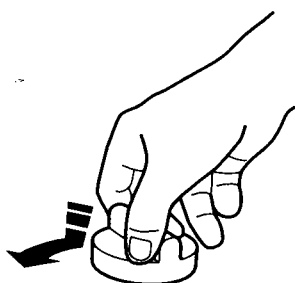

Control knobs

Push in control knobs before turning them to a setting. Set them anywhere between HI and OFF.

Surface unit markers

The solid dot in the surface unit marker shows which surface unit is turned on by that knob.



Power on lights

When you use a control knob to turn on a surface unit, the Power On Light by that knob will glow.



FRONT

Hot surface indicator lights

The Hot Surface Indicator Lights on the cooktop surface will glow when the surface units get hot. The Indicator Lights will continue to glow as long as the surface units are too hot to touch, even after they are turned off.

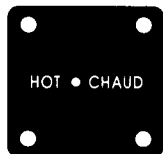

("CHAUD" is French for "HOT")

⚠ WARNING



Fire Hazard

Turn off all controls when done cooking.

Failure to do so can result in death, fire, or burns.

Control setting guide

For best results, start cooking at the high setting; then turn the control knob down to continue cooking.

SETTING	RECOMMENDED USE
HI	<ul style="list-style-type: none"> • To start foods cooking. • To bring liquids to a boil.
MED HI	<ul style="list-style-type: none"> • To hold a rapid boil. • To fry chicken or pancakes.
MED	<ul style="list-style-type: none"> • For gravy, pudding, and icing. • To cook large amounts of vegetables.
MED LO	<ul style="list-style-type: none"> • To keep food cooking after starting it on a higher setting.
LO	<ul style="list-style-type: none"> • To keep food warm until ready to serve.

Using and Caring for Your Cooktop

Using the dual-size surface unit (some models)

You can use the right rear surface unit as either a small diameter, lower wattage element or large diameter, full wattage element.

Use both elements
for larger pans



Use small element
for smaller pans

To use the small element (for smaller pans):

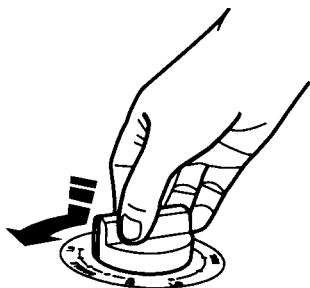

- **Push in and turn** the control knob to the left (counterclockwise) to the desired setting in the area marked "SINGLE".

To use both elements (for larger pans):

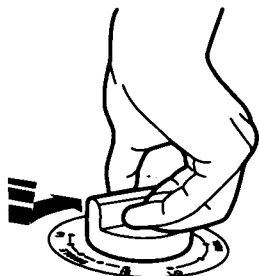

- **Push in and turn** the control knob to the right (clockwise) to the desired setting in the area marked "DUAL".

NOTE: You can turn the control knob in either direction to reach "OFF".

The ceramic glass cooktop

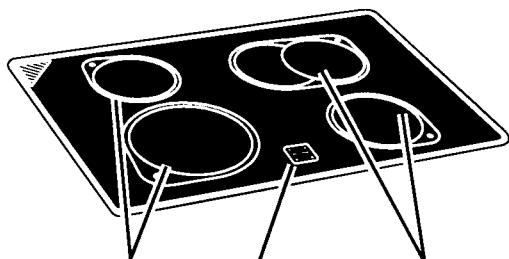

Standard
elements

Hot surface
indicator
lights

Halogen
elements
(some
models)

Cooking on the ceramic glass cooktop is almost the same as cooking on coil surface units. There are, however, a few differences:

- **The cooking surface** area will glow red when the element is turned on. You will see the element cycling on and off – even on the HI setting – to help the area stay at the temperature setting you choose.
- **Make sure** the bottoms of pots and pans are clean and dry before cooking. Food and water particles left on the bottoms can leave deposits on the cooktop when it is heated.
- **Wiping off** the cooktop before and after each use will help keep the surface free from stains and give you the most even heating. See pages 14 and 15 for care and cleaning suggestions.
- **Do not cook** foods directly on the cooktop.
- **Lift pots and pans** onto and off of the cooktop. Sliding pots and pans on the cooktop could leave marks that are difficult to remove or could leave permanent marks.
- **Do not cook** popcorn that comes in prepackaged aluminum containers on the cooktop. The container could leave aluminum marks on the cooktop that cannot be removed completely.

Using and Caring for Your Cooktop

- **Do not use** the cooktop as a cutting board.
- **Do not allow** anything that could melt, such as plastic or aluminum foil, to come in contact with the cooktop while it is hot.
- **Dropping** a heavy or hard object on the cooktop could crack it. Be careful when using heavy skillets and large pots. Do not store jars or cans above the cooktop.
- **Sugary spills** and soils can cause pitting. See page 15 for more information.

Cookware tips

- **Select a pan** that is about the same size as the surface unit.

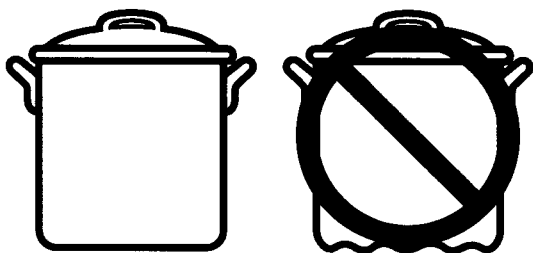

- **NOTE: For best results and greater energy efficiency**, use only flat-bottomed cookware that makes good contact with the surface units. Cookware with rounded, warped, ribbed (such as some porcelain enamelware), or dented bottoms could cause uneven heating and poor cooking results.

You can, however, use the newer cookware available with slightly indented bottoms or very small expansion channels. This cookware is specially designed to provide the good contact needed for best cooking results.

Also, woks, canners, and teakettles with flat bottoms suitable for use on your cooktop are now available in most stores that sell housewares.

- **The pan** should have straight sides and a tight-fitting lid.
- **Choose medium to heavy gauge** (thickness) pans that are fairly lightweight.
- **The pan material** (metal or glass) affects how fast heat transfers from the surface unit through the pan material and how evenly heat spreads over the pan bottom. Choose pans that provide the best cooking results.

- **Handles** should be made of sturdy, heat-resistant material and be securely attached to the pan.
- **With your hand**, feel the bottom of your pans while they are cool for nicks and scratches. Nicks and scratches on pan bottoms will scratch the ceramic glass cooktop.
- **Make sure bottoms** of pans are clean and dry before using on cooktop.
- **Avoid spillovers** on cooktop. Use pans with tall sides.
- **Do not** cook food directly on cooktop.

NOTE: Do not leave empty cookware, or cookware which has boiled dry, on a hot surface unit. The cookware could overheat and damage the cookware or surface unit.

Home canning information

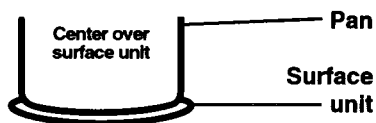

- **Use the largest surface unit** for best results. Also, use a canner/pan which can be centered over the surface unit.
- **Start with hot water.** This reduces the time the control is set on high. Reduce heat setting to lowest position needed to keep water boiling.
- **Refer** to your canner manual for specific instructions.



Using and Caring for Your Cooktop

Caring for your cooktop

This cooktop is designed for easy care. However, ceramic glass cooktops need to be maintained differently than standard electric coil elements. Foods spilled directly on the cooktop will not burn off as on coil elements. Because of this, the surface should be dust-free and soil-free before heating.

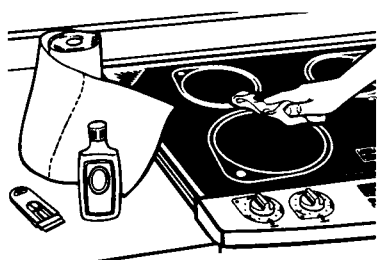

Your cooktop has been prepolished at the factory for improved protection and cleanability. The Cooktop Polishing Creme, a paper towel or a sponge, and a single-edge razor blade in a holder is all you need to clean your cooktop. For proper cleaning methods, please review the chart on page 15. Follow this chart after each use to ensure top performance and to preserve that uniquely elegant look.

NOTE: Let cooktop cool before cleaning.

To avoid damaging the cooktop, follow these instructions:

- **Remove sugar spills** and soils from the cooktop while the surface is still warm to avoid pitting on the surface.
- **Marks from sliding** metal pans on the cooktop are difficult to remove completely. Use cooktop polishing creme to clean the area. Several applications may be necessary.
- **Do not use** steel wool, plastic cleaning pads, abrasive powdered cleansers, chlorine bleach, rust remover, ammonia, or glass cleaning products with ammonia. These products could damage the cooktop surface.

Using and Caring for Your Cooktop

Cleaning steps:

- 1. Most spills** (except sugary spills and soils – see chart on this page) can be wiped off easily using a paper towel or clean, damp sponge as soon as Hot Surface Indicator Light(s) goes off.
- 2. For stubborn spills**, rub Cooktop Polishing Creme into cooked-on soil using a paper towel. If some soil remains, leave some creme on the spot(s) and follow Step 3.
- 3. Carefully scrape** spots with a single-edge razor blade in a holder.
- 4. Finish by polishing** entire cooktop with Cooktop Polishing Creme and a paper towel.

To order Cooktop Polishing Creme (Part No. 3184477), call 1-800-422-1230 and follow the instructions and telephone prompts you hear.

How to keep your cooktop looking like new:

IF THERE ARE	WHAT TO DO
Sugary spills and soils (such as jellies and candy syrups)	To prevent pitting on the cooktop, wipe up with a paper towel or clean, damp sponge while ceramic glass surface is still warm. Remove as soon as possible after spill occurs.
Dark streaks, specks, and discoloration	Use Cooktop Polishing Creme or nonabrasive cleanser with a damp paper towel or sponge.
Metal marks (from copper or aluminum pans)	Use Cooktop Polishing Creme or nonabrasive cleanser with a damp paper towel or sponge before heating the cooktop again. If heated before cleaning, metal marks may not come off.
Tiny scratches or abrasions	Scratches and abrasions do not affect cooking. In time, they will become less visible as a result of cleaning. To prevent scratches and abrasions, use Cooktop Polishing Creme regularly.

NOTE: Always wipe and dry your cooktop thoroughly after using cleanser to prevent streaking or staining.



Using and Caring for Your Cooktop

Using and replacing the surface light

(Freestanding model)

The surface light is in the backguard. It is controlled by the Surface Light Command Pads on the control panel. The On Command Pad turns on the light immediately and keeps it on until you press OFF. The Night Command Pad will turn on the surface light automatically when the light in the room is low enough to require a night light. When the night light comes on, it will also dim all lights appearing on the display. Press OFF to turn off the regular surface light or press NIGHT again to turn off the night light.

To turn on the surface light:

PRESS



To turn off surface light:

PRESS



To turn on night light:

PRESS



"NIGHT LIGHT" shows on the display when the night light is on.

To turn off night light:

PRESS again



Replacing the surface light:

1. **Unplug** appliance or **disconnect** at main power supply.

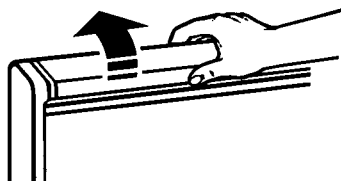

2. **Flip up** the top of the backguard.

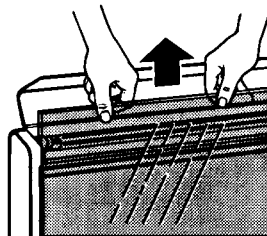

3. **Pull up** glass on front of backguard.

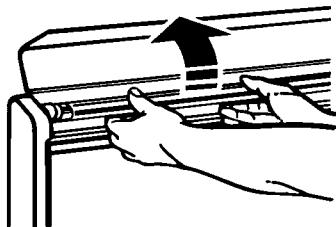

4. **Grasp** the fluorescent light tube at both ends. **Turn** the tube approximately 90° in either direction until both ends come out of the receptacles. **Replace** with a 20-watt cool-white fluorescent light tube.



5. If the surface light still does not work, you may need to replace the starter. The starter is a knob-shaped part located on the right side of the backguard, under the light tube.

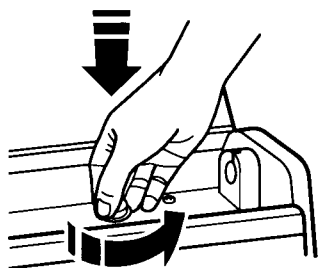

To remove and replace the starter, first remove light tube. Push starter in and turn approximately 90° counterclockwise. Pull starter out of recessed area. You can find replacement starters at stores that sell fluorescent light tubes.

6. Replace glass and close the top panel. Plug in appliance or reconnect at main power supply.

Using and Caring for Your Oven

This section tells you, step by step, how to operate all oven functions controlled by the electronic control. Carefully follow these instructions, along with the cooking tips and cleaning information, for successful use of your range. Your model may not have all the features shown on the control display.

Using the electronic oven control

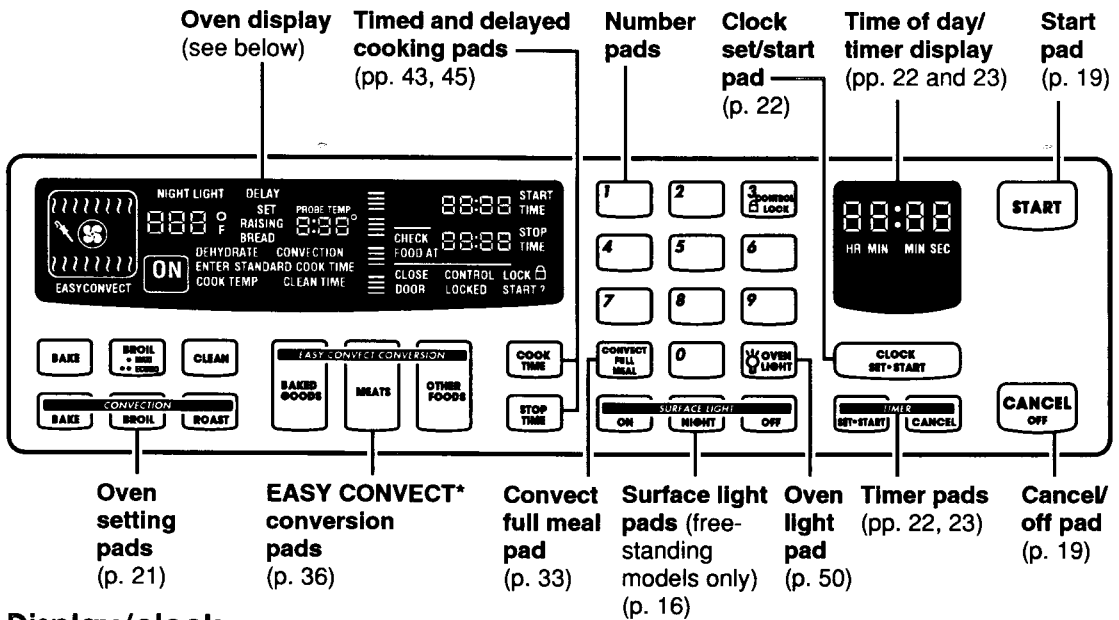

Display/clock

- **When you first plug in the range**, a tone will sound, the display will be fully lit for a few seconds, and the display will show the last time set and "PF" (power failure). If, after you set the clock (page 22), the display again shows "PF", your electricity was off for a while. Reset the clock.
- **The time display will show "Err"** and 3 short tones will sound if a time or temperature is incorrectly entered.

NOTE: If you press a command pad several times, the pad can stop working. If you wait a few seconds, you can use the pad again. When you first use the pad again, you may have to hold down on the pad a short time to get it to work.

Fahrenheit/celsius

- **You can set your oven to cook in Celsius instead of Fahrenheit** by opening

the oven door, then pressing BROIL for 5 seconds. (You will know you are in Celsius when "F" disappears.) To switch back to Fahrenheit, press BROIL again for 5 seconds. ("F" will reappear.)

If you need to convert temperatures from Celsius to Fahrenheit or vice versa, you can refer to this chart:

Temperature replacement values

38°C-100°F	163°C-325°F
60°C-140°F	177°C-350°F
66°C-150°F	191°C-375°F
77°C-170°F	204°C-400°F
93°C-200°F	218°C-425°F
121°C-250°F	232°C-450°F
135°C-275°F	246°C-475°F
149°C-300°F	260°C-500°F

Starting an operation

After programming a function, you must press the Start pad to start the function. If you do not press the Start pad within 5 seconds of programming, "START?" will show on the display as a reminder.



Canceling an operation

The Cancel/Off pad will cancel any function, except for the Clock Set/Start and Timer functions. When you press the Cancel/Off pad, the large display will show the time of day or, if Timer is also being used, the time remaining.



Changing audible signals

Audible signals tell you if a function is entered correctly or not. They also tell you when a cycle is completed.

To shut off end-of-cycle tone:

Open the door

Then

PRESS and hold for 5 seconds



To change pitch and loudness of key tone:

Open the door

Then

PRESS and hold for 5 seconds



To shut off reminder tones:

Open the door

Then

PRESS and hold for 5 seconds



To shut off key entry tone:

Open the door

Then

PRESS and hold for 5 seconds



A short tone will sound to tell you the signals have been changed. Repeat step above to turn the signals back on.

Using the control lock

The control lock prevents unwanted use of the oven by disabling the control panel command pads.

NOTES:

- **Control lock** is only available when oven is not active or set.
- **Control lock** will not disable the Timer.
- **Set control lock** when cleaning the control panel to prevent oven from accidentally turning on.

To lock or deactivate the control panel:

Open the door, then press and hold the Control Lock pad (Number Pad 3) for 5 seconds. A single tone will sound and "CONTROL LOCK 

To unlock the control panel:

Open the door, then press and hold the Control Lock pad (Number Pad 3) for 5 seconds. A single tone will sound after 5 seconds and "CONTROL LOCK 



Using and Caring for Your Oven

Setting your range for the Sabbath†

If you want to set your range to meet “no work” requirements for the Sabbath, follow these steps:

1. **Turn** the oven light on or off (see page 50). This light will stay turned on or off (whichever you set) while in the Sabbath mode. Opening the door will not turn on the oven light if it is programmed to be off.
2. **If a power failure occurs**, the oven will automatically run the Favorite Cycle set in Convect Full Meal when power is back on. **To prevent the oven from running a cook time and turning off at the end of that time, set CONVECT FULL MEAL with the bake cycle you want to use during the Sabbath.** (Be sure to set a cook time of “0”.) To set a favorite cycle:
 - A. **Press** CONVECT FULL MEAL.
 - B. **Press** BAKE.
 - C. **Press** Number Pads to enter the temperature.
 - D. **Press** COOK TIME, followed by Number Pad 0.
 - E. **Press** CONVECT FULL MEAL to save the cycle.
 - F. **Press** CONVECT FULL MEAL again to confirm that setting is programmed.
 - G. **Press** CANCEL/OFF.

NOTE: After a long power failure, you may see the oven temperature increase on the display. This will happen only when the oven has cooled enough to require preheating. The temperature display will stop changing once the Favorite Cycle’s set temperature is reached.

† Star K certification pending. Full certification by Star K is expected in early 1997. Information is accurate as of 9/96.

3. **Press** BAKE.
4. **Press** Number Pads to set the temperature you want.
5. **Press** START. **Wait** for the oven to preheat. (A tone will sound when oven is preheated.)
6. **Open the door**, then press and hold Number Pad 6 for 5 seconds to go into the Sabbath mode.
NOTE: Use the Sabbath mode with the Bake function only.

What your oven will do while in the Sabbath mode:

- **The time display** will show “SAbb” to tell you that the oven is in the Sabbath mode.
- **The ON Indicator Light** will light up when the heating element turns on, and ON will go off when the heating element turns off.
- **To prevent accidental key presses**, the key pads will only work after you press them for 1 second.
- **No tones** will sound.

To end the Sabbath mode:

- **Open the door**, then press CANCEL/OFF for 1 second. Next, **press and hold** Number Pad 6 for 5 seconds. (Or you can **press and hold** Number Pad 6 for 5 seconds first, followed by CANCEL/OFF.)

Oven settings

This chart tells you when to use each setting. It also explains what elements heat up for each setting.

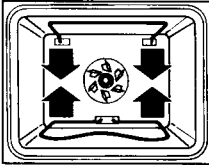
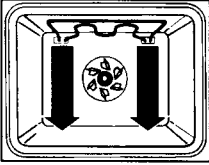
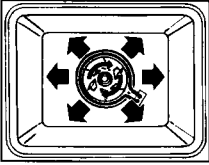
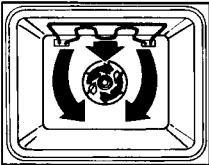
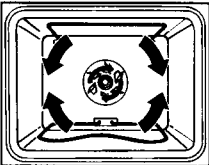
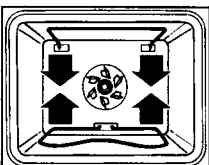
SETTING	DIAGRAM	SETTING INFORMATION
<p>BAKE Use this setting for baking and heating casseroles.</p>		<ul style="list-style-type: none"> • The bottom element and outer top element heat up. • During baking, the elements will turn on and off to maintain the oven temperature.
<p>BROIL (MAXI/ECONO) Use this setting for broiling regular-sized and smaller cuts of meat, poultry, and fish.</p>		<ul style="list-style-type: none"> • Both top elements heat during Maxi Broil. (Maximum browning coverage) • Only the inner element heats up during Econo Broil. (Browning coverage in center only)
<p>CONVECTION BAKE Use this setting for foods which require gentle heating and for baking breads and cakes. Use also when baking large quantities of food on more than one oven rack.</p>		<ul style="list-style-type: none"> • For faster preheating, the bottom element and outer top element heat up until oven reaches desired temperature. After preheat, only the rear element heats up. • For even heating, the fan at the back of the oven circulates air in the oven cavity.
<p>CONVECTION BROIL Use this setting for broiling thick cuts of meat.</p>		<ul style="list-style-type: none"> • Both top elements heat up. • For even heating, the fan at the back of the oven circulates air in the oven cavity.
<p>CONVECTION ROAST Use this setting for roasting and baking on one rack.</p>		<ul style="list-style-type: none"> • The bottom element and outer top element heat up. • For even heating and faster cooking, the fan at the back of the oven circulates air in the oven cavity.
<p>CLEAN Use this setting for self-cleaning only.</p>		<ul style="list-style-type: none"> • The bottom element and outer top element heat up.



Using and Caring for Your Oven

Setting the clock

NOTE: If an oven function is active or programmed, you cannot change the clock.

1. Press Clock Set/Start pad.

PRESS



YOU SEE



2. Set time.

PRESS



YOU SEE



3. Start clock.

PRESS



YOU SEE



If time has not been entered correctly, three short tones will sound and “Err” will be displayed. The display will show the closest valid time. Repeat Steps 2 and 3 to re-enter the time of day.

NOTE: You can clear the time of day from the display by opening the door then pressing and holding CLOCK SET/ START for 5 seconds. Repeat to see time of day on display again.

Using the timer

The Timer does not start or stop the oven. It works like a regular kitchen timer. It can be set in hours and minutes up to 99 hours, 59 minutes or in minutes and seconds up to 99 minutes, 59 seconds.

1. Press Timer Set/Start pad.

- **Once** to set hours and minutes
- **Twice** to set minutes and seconds

PRESS



YOU SEE



(example shows hours and minutes timer setting 1)

2. Set time.

PRESS

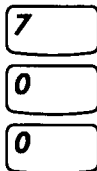

YOU SEE



(example shows a 7-hour timer setting)

3. Start Timer.

The Timer will begin counting down immediately after you press the Timer Set/Start pad or Start pad.

PRESS



YOU SEE



4. When time is up, turn off Timer.

When time is up, you will hear four tones (if tones are not turned off – see page 19). Press the Timer Cancel pad to clear the display.

YOU SEE



To change the timer during its operation:

1. Press Timer Set/Start pad.
2. Enter new desired time.
3. Press Timer Set/Start pad.

To cancel the timer during its operation:

You can cancel the Timer any time during its operation. Press the Timer Cancel pad.

PRESS





Using and Caring for Your Oven

Baking or convection baking

1. Position racks.

For correct rack placement, see “Rack positions” on page 27 and “Rack placement” chart on page 28.

NOTES:

- **Before turning oven on** position oven rack(s) in desired location.
- **Be sure** the rack(s) is level.
- **Use pot holders or oven mitts to protect hands** if rack(s) must be moved while oven is hot.
- **Do not let** pot holder or oven mitt touch hot elements.

NOTE: See “Cooking tips” on page 27 for additional baking and convection baking tips.

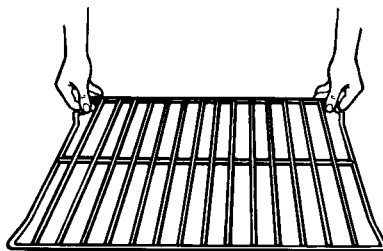

2. Choose baking setting.

PRESS



OR

PRESS



YOU SEE



YOU SEE



3. Set temperature (optional).

Do this step if you want to set a temperature other than 350°F for Bake or 300°F for Convection Bake.

NOTE: See a reliable cookbook or your convection oven cookbook for temperature recommendations.

PRESS



YOU SEE

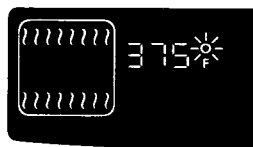

(example for Bake at 375°F)

4. Preheat oven.

After the temperature reaches 170°F, the temperature display will show the actual oven temperature at each 5°F increase and stop at the set temperature. One long tone will sound when oven is preheated.

PRESS



YOU SEE

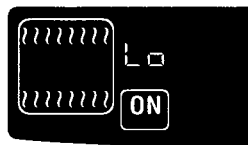

(example for Bake)
("Lo" is displayed
after 5 seconds if
oven temperature
is below 170°F)

5. Put food in oven.

NOTE: If you want to change the baking temperature after baking has begun, repeat Steps 2, 3, and 4.

6. After cooking, turn off oven.

PRESS



YOU SEE

(display will go blank)

Roasting

1. Prepare oven.

Position the rack properly. For correct rack placement, see "Rack positions" on page 27. Place food in the oven. For large roasts and turkeys, place rack in position 1 or 2.

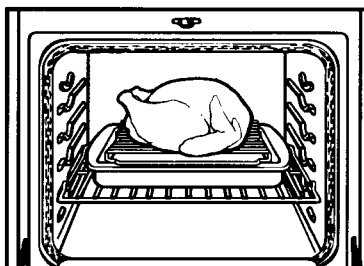

continued on next page



Using and Caring for Your Oven

2. Choose setting.

PRESS



YOU SEE

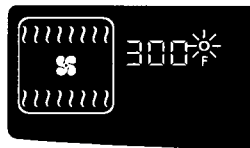

3. Set temperature (optional).

Do this step if you want to set a temperature other than 300°F.

NOTE: See a reliable cookbook or your convection oven cookbook for temperature recommendations.

PRESS



YOU SEE

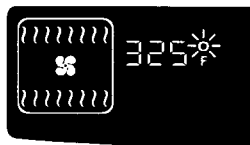

(example shows 325°F temperature setting)

4. Start oven.

NOTES:

- **After the temperature** reaches 170°F, the temperature display will show the actual oven temperature at each 5°F increase and stop at the set temperature. One long tone will sound when oven is preheated.
- **If you want to change** the roasting temperature after roasting has begun, repeat Steps 2, 3, and 4.

PRESS



YOU SEE

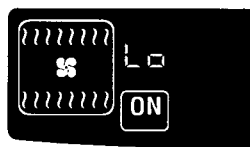

(“Lo” is displayed after 5 seconds if oven temperature is below 170°F)

5. After cooking, turn off oven.

PRESS



YOU SEE

(display will go blank)



Cooking tips

Baking/convection baking tips

The hot air must circulate around the pans in the oven for even heat to reach all parts of the oven. This results in better baking.

For best air circulation:

- **Place** the pans so that one is not directly over the other.



- **For best results**, allow $1\frac{1}{2}$ to 2 inches of space around each pan and between pans and oven walls.
- **When baking with one pan**, place pan in the center of the oven rack.

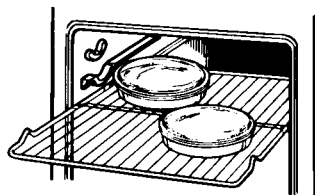

- **When baking with two pans**, place pans in opposite corners of the oven rack.

NOTES:

- **“Oven peeking”** may cause heat loss, longer cooking times, and unsatisfactory baking or roasting results. Rely on your timer.
- **Do not allow pans** to touch the heat sensor on the left wall near the back. Poor baking may result.

Rack positions

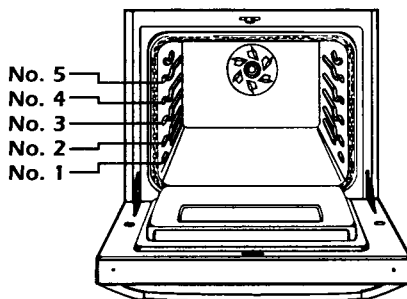

Your oven has three straight racks and five rack positions. Rack position 5 is the highest position, or farthest from the bottom of the oven. Rack position 1 is the lowest position, or closest to the bottom of the oven.



Using and Caring for Your Oven

Baking tips

(Bake pad)

For proper cooking, follow these guidelines:

- When using one rack, place the rack so the top of the food will be centered in the oven.
- When using more than one rack, use the Convection Bake setting.
- Use only one cookie sheet in the oven at a time when using the Bake setting.

Bakeware tips

- When baking with insulated cookie sheets or baking pans, place them in the bottom third of the oven. You may need to increase the recommended baking times, so test for doneness before removing from the oven.
- When using ovenproof glassware or dark bakeware, reduce the oven temperature by 25°F, but use the same baking time. Because these pans absorb heat, producing darker bottom browning and crispier crusts, place the rack in the center of the oven. When baking pies and bread, you can use the temperature suggested in the recipe.

Rack placement for specific foods:

(For rack positions, see “Rack positions” on page 27.)

FOOD	RACK POSITION
Frozen pies	2
Angel food and bundt cakes, most quick breads, yeast breads, casseroles, meats	1 or 2
Cookies, biscuits, muffins, cakes, nonfrozen pies	2 or 3

NOTE: For additional baking tips see “Baking or convection baking” on page 24.

Using aluminum foil in the oven (for thermal baking)

Use aluminum foil to catch spillovers from pies or casseroles.

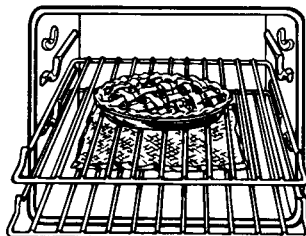

- Place the foil on the oven rack below the rack with the food. Turn foil edges up and make sure foil is about 1 inch (3 cm) larger all around than the dish holding the food.
- Do not cover the entire rack with aluminum foil. It will reduce air circulation and cause poor cooking results.
- Do not line oven bottom or entire oven rack with foil or other liners. It could affect the quality of your baking.



Convection baking tips

(Convection Bake pad)

- **Do not use** aluminum foil when convection baking. Aluminum foil may block airflow.
 - **Reduce** recommended recipe oven temperature by approximately 25°F. See recipe adaption chart in your convection oven cookbook for recommended temperatures, or use EASY CONVECT* Conversion (see page 36).
 - **For most recipes**, you can reduce convection baking time compared to standard baking times. See recipe adaption chart or convection baking chart in your convection oven cookbook for recommended baking times, or use EASY CONVECT Conversion (see page 36).
- NOTE:** Cooking time may be longer when you use more than one rack.
- **When baking on two or three racks**, use the Convection Bake setting for more even results. (You can, however, use only one rack when Convection Baking.)

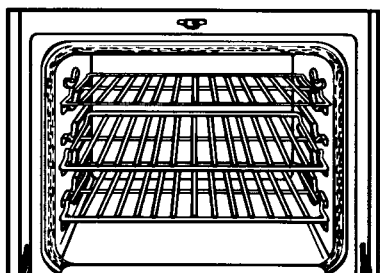

- **To use three racks during convection baking**, place one rack in position 5 (the highest position), another rack in position 1 (the closest to the oven bottom), and the third rack in position 3. This allows all three racks to be an equal distance apart for better baking.
- **Stagger** cake pans or other cookware in opposite directions on each rack when three racks are used.

NOTE: For additional convection baking tips see “Baking or convection baking” on page 24.

Roasting tips

- **Spatter can be reduced** by lining the bottom of the roasting pan with lightly crushed aluminum foil.
- **Use an accurate meat thermometer or temperature probe** (see page 31) to determine when meat has reached desired degree of doneness. Insert the thermometer or probe into the center of the thickest portion of the meat or inner thigh or breast of poultry. For an accurate reading, the tip of the thermometer or probe should not touch fat, bone, or gristle.
- **After reading the thermometer once**, push it further into the meat ½ inch or more and read again. If the temperature drops, return the meat to the oven for more cooking.
- **Check pork and poultry** with a thermometer in two to three places to ensure adequate doneness.
- **Poultry and roasts will be easier to carve** if loosely covered with foil and allowed to stand 10-15 minutes after removal from the oven.
- **You can reduce** roasting times and temperatures for most standard recipes when using the Convection Roast setting. See recipe adaption chart or convection roasting chart in your convection oven cookbook for recommended roasting times and temperatures, or use EASY CONVECT Conversion (see page 36).

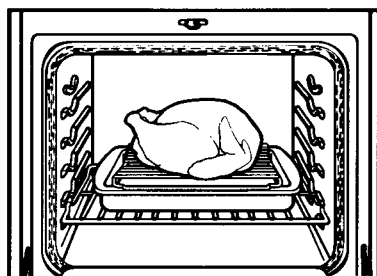

- **Use the convection roasting rack** on the broiler pan (both included with your range). (The convection roasting rack rests on the broiler pan, not inside it.) The long side of the rack should be parallel with the oven door for best heat distribution and airflow.

Using and Caring for Your Oven

Adjusting oven temperature

Although your new oven is properly adjusted to provide accurate temperatures, it may cook faster or slower than your old oven.

If, after using the oven for a period of time, you are not satisfied with the baking/roasting results, you can change the offset temperature by following the steps below. The control will “remember” the selected offset even after the power has been interrupted or lost.

NOTE: DO NOT measure oven temperature with a thermometer. Opening the oven door will lower the oven temperature and give you an inaccurate reading. Also, the thermometer temperature reading will change as your oven cycles.

1. Open the door, then press and hold Bake pad for 5 seconds.

Release the pad when a number appears on the temperature display and you hear a tone.

PRESS



Hold for 5 seconds

YOU SEE



(factory setting of “0”)

2. Set new offset temperature.

Each time you press the Bake pad, the displayed temperature will change by 5°F (3°C). You can set the temperature offset adjustment as low as -35°F (-21°C) or as high as +35°F (+21°C). (To determine the amount of adjustment needed, see the chart on page 31.)

NOTE: If there is no “F” after the temperature, you are in the Celsius mode.

PRESS



YOU SEE



(example when making oven 10°F hotter)

3. Enter the adjustment.

NOTE: If you press the Cancel/Off pad instead of the Start pad, the temperature offset will stay the same.

PRESS



YOU SEE

(display will go blank)

How to determine the amount of adjustment needed

The following chart tells you how much to adjust the offset temperature to get the desired cooking results. You can determine cooking results by amount of browning, moistness, and rising times for baked foods.

TO COOK FOOD ...	ADJUST BY THIS NUMBER OF DEGREES (FAHRENHEIT)
A little more	+5 to +10
Moderately more	+15 to +20
Much more	+25 to +35
A little less	-5 to -10
Moderately less	-15 to -20
Much less	-25 to -35

Using the temperature probe

The Temperature Probe is the most accurate guide to the degree of doneness of meat. Use it when baking, roasting any type of meat or poultry, or cooking casseroles with liquid.

NOTES:

- **Do not use** the Temperature Probe when broiling, convection broiling, dehydrating, or raising bread.
- **Unplug** the Temperature Probe before self-cleaning the oven.

1. Insert probe into food.

Insert the probe into the center of the thickest portion of meat or into the inner thigh or breast of poultry, away from fat or bone.

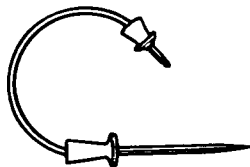

2. Put food in oven.

Place meat on the convection roasting rack, place rack on broiler pan, and place pan in the center of the oven.



3. Connect probe to oven.

Open the Temperature Probe cover located on the left side of the oven wall. Insert plug into jack. (Keep the top of the probe as far as possible from the heat source.)



YOU SEE



4. Close oven door.

continued on next page



Using and Caring for Your Oven

5. Set temperature (optional).

Do this step if you want to set an internal food temperature (from 130°F-190°F) other than 160°F.

NOTE: See a reliable cookbook or your convection oven cookbook for internal food temperature recommendations.

PRESS



YOU SEE



(example shows 150°F internal temperature setting)

6. Choose cook setting.

- BAKE,
- CONVECTION BAKE, or
- CONVECTION ROAST

PRESS



(example for Bake)

YOU SEE



7. Set temperature (optional).

Do this step if you want to set an oven temperature other than the one displayed.

NOTE: See a reliable cookbook or your convection oven cookbook for oven temperature recommendations.

PRESS



YOU SEE



(example shows 375°F temperature setting)

8. Start oven.

NOTES:

- If you do not choose a cook setting and press START, the display will show a bake setting at 350°F. If you want to bake at 350°F, press START to begin. If you want to cook with another setting or at another temperature, do Steps 6 and 7 above and press START.

- The temperature display will show the set oven temperature throughout temperature probe cooking.
- After the food temperature reaches 130°F, the probe display will show the actual food temperature at each 5°F increase and stop at the set temperature. Four tones will sound and "End" will show when food reaches the set temperature (unless tones have been shut off [see page 19]). The oven then shuts off.

PRESS



YOU SEE



(example for Bake)

- If you want to change the probe temperature after cooking has begun, repeat Steps 6, 5, and 8, in that order. At Step 6, you will be prompted for a new probe temperature. You may also change the oven temperature at this point by pressing the Bake pad again.

⚠ WARNING



Burn Hazard

Use an oven mitt to remove temperature probe.

Do not touch broil element.

Failure to follow these instructions can result in burns.

9. After cooking, unplug probe.

The probe symbol will remain lit until you unplug the Temperature Probe.

10. Remove food from oven.

(This prevents overcooking.)

11. Clean probe.

Wash with a soapy sponge and dry thoroughly. Use a plastic scouring pad to remove cooked-on foods. You can also clean the probe in a dishwasher.

Using Convect Full Meal

Convect Full Meal lets you choose from among 10 preset oven convection cooking cycles, all using the convection fan. These cycles store commonly used cooking times, cooking temperatures, and probe temperature settings.

Convect Full Meal saves you time by limiting the number of pads you have to press when cooking at a favorite setting. Convect Full Meal also lets you set your own favorite cycle (either convection or nonconvection).

1. Place food in cold oven.

If you need the Temperature Probe for your cycle (settings 5-8 in chart on page 35), insert probe into food. (Follow Steps 1-4 in "Using the temperature probe" on page 31.)

2. Press Convect Full Meal pad.

PRESS



YOU SEE



("C" stands for "cycle,"
"F" stands for "favorite")

continued on next page



Using and Caring for Your Oven

3. Press desired Number pad.

Use the "Convect full meal chart" on page 35 as your guide for selecting a cycle.

PRESS



YOU SEE



(example for cycle 1)

NOTES:

- **You can change** the Convect Full Meal cycle any time before pressing the Start pad by repeating Step 3.
- **You can program your own cycle**, which you can then select in the future by pressing just CONVECT FULL MEAL and START. (See page 35 for more information.)



4. Start oven.

PRESS



YOU SEE



5. When the Convect Full Meal cycle is done:

Four tones will sound, followed by four reminder tones every minute until you open the door, remove the probe, or press the Cancel/Off pad (if the reminder tone is not disabled).

YOU SEE

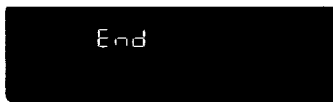

Convect full meal chart

CYCLE NUMBER	CONVECTION CYCLE	OVEN TEMP	TIME OR PROBE TEMP	FOOD OR MEAL
1	Conv. Bake	350°F	45 min	Meal # 1: Chicken pieces, Fruit crisp, Vegetable casserole
2	Conv. Bake	350°F	1 hr	Meal # 2: Macaroni and cheese, Baked winter squash, Fruit pie
3	Conv. Bake	350°F	1 hr 15 min	Meal # 3: Precooked ham, Baked potatoes, Quick bread loaf OR Baked potatoes only
4	Conv. Bake	375°F	55 min	Meal # 4: Beef stew, Scalloped potatoes, Frozen fruit pie
5	Conv. Roast	300°F	140°F	Beef roast rare
6	Conv. Roast	300°F	160°F	Beef roast medium
7	Conv. Roast	300°F	170°F	Beef roast well Pork roast Meat loaf
8	Conv. Bake	325°F	150°F	Casseroles
9	Conv. Bake	325°F	3 hr	Pot roast with vegetables – 3 lbs
0	Conv. Roast	400°F	18 min	Pizza

To program your own cycle:

1. **Press** CONVECT FULL MEAL.
2. **Press** the Command Pad for the cook setting you want (for example, BAKE).
3. **Enter** the temperature and cook time you want. (The default is Bake at 170°F for 2 hours.) Entering a cook time of 0 minutes lets you do untimed cooking.
4. **To save only, press** CONVECT FULL MEAL.

To cook with this cycle immediately and save it, press START.

When programming your own cycle:

1. **Start** with meat or main dish items (times are more critical with these items).
2. **Choose** baked goods with bake temperatures similar to those of meat or main dish items. Convection baking time of +/-10 to 15 minutes and temperatures of +/-25 to 50 degrees are acceptable.
3. **Choose** vegetables and fruits last.



Using and Caring for Your Oven

Using EASY CONVECT* Conversion

EASY CONVECT Conversion lets you convection cook without entering convection cook temperatures and times. Simply enter the standard cook temperature and time for the food to be cooked. The oven will reduce the temperature, or the temperature and time, for convection cooking. (Convection temperatures and times are not as long because the heated air is circulated in the oven cavity for quicker cooking.)

NOTE: The converted temperatures and times are not precise because the food categories you choose from are general. (See "EASY CONVECT Conversion setting chart" on page 38 for which foods you can cook in each category.) To ensure proper cooking, the oven will prompt you to check food at the end of cook time. If food needs more cooking, the oven will continue to cook. If food does not need more cooking, press CANCEL/OFF.

WARNING

Food Poisoning Hazard

Do not let food sit in oven more than one hour before or after cooking.

Doing so can result in death, food poisoning, or sickness.

1. Place food in oven.

2. Press one of three EASY CONVECT Conversion Pads.

Example for Meats:

PRESS



YOU SEE



3. Enter standard cook temperature.

PRESS



YOU SEE

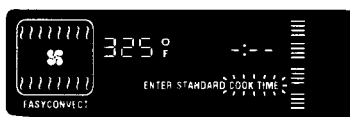

(example showing 325°F – cooking without temperature probe)

4. Enter standard cook time.

NOTES:

- **This step** is not needed when using the temperature probe.
- **To delay convection cooking**, after Step 4, press the Stop Time pad and enter the desired stop time. Cooking will start at the time equal to the stop time less the cook time. (Example: A cook time of 1 hour and a stop time of 4:00 would give you a start time of 3:00.)

PRESS

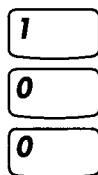

YOU SEE



(example showing 1 hour)

5. Start oven.

NOTE: The actual temperature reduction and time savings are different for each food category and oven type.

PRESS



YOU SEE



(display shows temperature reduced by 25°F – nondelayed cooking)

6. At end of cook time (nondelayed cooking):

YOU SEE



7. Open door and check food (nondelayed cooking).

If you want to continue cooking, close door and the oven will continue cooking.

If you do not want to continue cooking, press the Cancel/Off pad.

YOU SEE

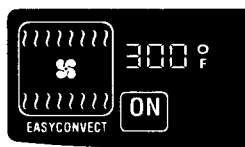

8. When stop time is reached (delayed cooking only):

Four tones will sound, followed by four reminder tones every minute, until you open the door, remove the probe, or press the Cancel/Off pad.

YOU SEE





Using and Caring for Your Oven

EASY CONVECT* Conversion setting chart

EASY CONVECT SETTING	FOODS YOU CAN COOK WITH THIS SETTING
Baked Goods	Cakes, cookies, muffins, quick breads, biscuits, yeast bread
Meats	Roasts, ham, whole chicken, chicken pieces, chops, meatloaf NOTE: Turkey or large poultry are not included because their cooking times vary.
Other Foods	Egg and cheese dishes, fish, casseroles, frozen convenience foods, potatoes, squash, meat pies, fruit pies

Broiling

NOTE: Preheating is not necessary when broiling.

1. Position rack.

See "Thermal broiling chart" on page 42 for recommended rack positions.

NOTES:

- **Before turning oven on** position oven rack(s) in desired location.
- **Be sure** the rack(s) is level.
- **Use pot holders or oven mitts to protect hands** if rack(s) must be moved while oven is hot.
- **Do not let** pot holder or oven mitt touch hot broil element.

NOTE: See "Broiling tips" on page 41 for additional broiling tips.

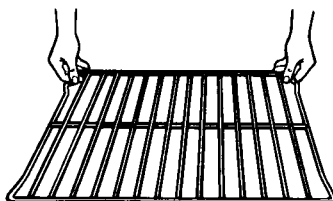

2. Put food in oven.

Place food on grid in broiler pan and place in center of the oven rack.



Broiler grid



Broiler pan

3. Position door.

Close the door to the Broil Stop position (open about 6 inches [15 cm]). The door will stay open by itself. Door must be partly open for oven to maintain proper temperatures.

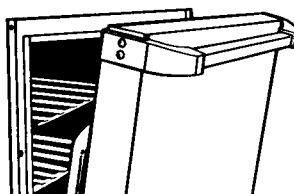

4. Press Broil pad.

Once for Maxi Broil

OR

Twice for Econo Broil

PRESS



YOU SEE



(example for Maxi Broil)

PRESS



YOU SEE



(example for Econo Broil)

5. Set temperature (optional).

Do this step if you want to use variable temperature broiling (see below).

NOTE: See “Thermal broiling chart” on page 42 for temperature recommendations.

PRESS



YOU SEE



(example shows 325°F broiling temperature for Maxi Broil)

6. Start oven.

NOTE: If you want to change the broiling temperature after broiling has begun, repeat Steps 4, 5, and 6.

PRESS



YOU SEE



(example for Maxi Broil)

7. When broiling is done, turn off oven.

PRESS



YOU SEE

(display will go blank)

Variable temperature broiling

• If food is cooking too fast or you want the food to broil slower from the start, set the broil temperature between 170°F and 325°F. These temperature settings allow the broil heating element to cycle and to slow cooking. The lower the temperature, the slower the cooking.

• **Fish and chicken** are some foods that may cook better if you use lower broiling temperatures.



Using and Caring for Your Oven

Convection broiling

Convection broiling is actually high-temperature convection roasting. Use this setting when broiling thick cuts of meat. Results are similar to those you get when using a rotisserie.

1. Position rack.

See “Thermal broiling chart” on page 42 for recommended rack positions.

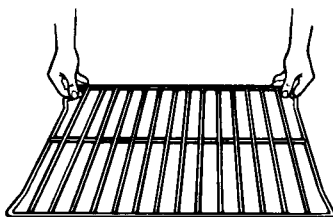

2. Put food in oven.

Place food on grid in broiler pan and place in center of the oven rack. Turn the pan so the long side is parallel to the oven door for the most even heat and the best airflow.

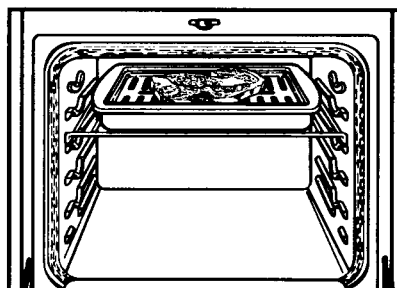

3. Close door.

NOTE: Do not try to convection broil with the door open. The fan will not operate.

4. Choose Convection Broil setting.

PRESS



YOU SEE





5. Set temperature (optional).

Do this step if you want to set a temperature (up to 450°F) other than 450°F.

NOTE: See a reliable cookbook or your convection oven cookbook for temperature recommendations.

PRESS

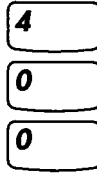

YOU SEE

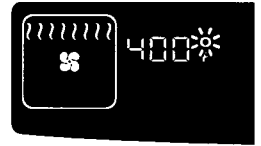

(example shows 400°F temperature setting)

6. Start oven.

NOTE: If you want to change the convection broiling temperature after broiling has begun, repeat Steps 4, 5, and 6.

PRESS



YOU SEE

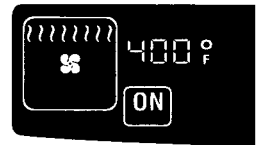

7. When broiling is over, turn off oven.

PRESS



YOU SEE

(display will go blank)

Broiling tips

- **Always start** broiling with a cold broiler pan for even results.
- **To retain more natural juice**, do not pierce meat with a fork.
- **Trim** the outer layer of fat from steaks and chops.
- **Slit** fatty edges to prevent meat from curling during broiling.
- **Use a nonstick cooking spray or vegetable oil** on the broiler pan and grid when broiling fish to prevent sticking.

NOTE: See “Broiling” on page 38 for additional broiling tips.

Broiling rack positions

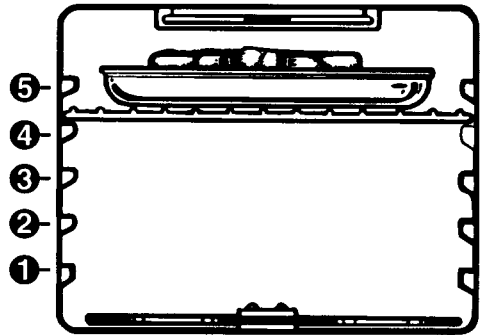



Using and Caring for Your Oven

Thermal broiling chart

The recommended rack position is numbered lowest (1) to highest (5).

MEAT	RACK POSITION	TEMPERATURE	APPROXIMATE TIME (MINUTES)	
			SIDE 1	SIDE 2
Steak, 1" thick	4	500°F		
• rare			4	4
• medium			6	6
• well-done			8	8
Steak, 1½" thick	4	500°F		
• rare			8	8
• medium			10	10
Hamburger patties or steaks, ½" thick or less				
• medium	4	500°F	6	4
Lamb chops, 1" thick	4	400°F	9	9
Ham slice, ½" thick	4	500°F	5	5
precooked, 1" thick	4	500°F	10	10
Pork chops, 1" thick	4	450°F	12	12
Frankfurters	4	500°F	4	4
Chicken pieces	3	500°F	16	16
Fish, 1" thick	3	350°F	10	10
Beef liver, ½" thick	4	350°F	5	5

Temperatures and times are guidelines only and may need to be adjusted to individual tastes.



Timed cooking

The electronic clock/oven control will turn the oven on and off at times you set, even when you are not around.

Delayed time baking/roasting is ideal for foods which do not require a preheated oven, such as meats and casseroles. **Do not use delayed time cooking for cakes, cookies, etc. – they will not rise properly. Before using timed cooking, make sure the clock is set to the correct time of day.** (See “Setting the clock” on page 22.)

To start baking/roasting now and stop automatically:

1. Prepare oven.

Position the oven rack(s) properly and place the food in the oven. For correct rack placement, see “Rack positions” on page 27 and “Rack placement” chart on page 28.

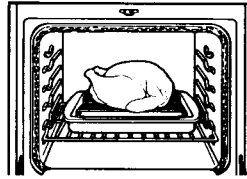

2. Choose cook setting.

- BAKE,
- CONVECTION BAKE, or
- CONVECTION ROAST

PRESS



YOU SEE

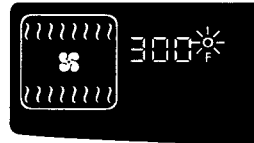

(example for Convection Roast)

3. Set temperature (optional).

Do this step if you want to set a temperature other than the one displayed.

NOTE: See a reliable cookbook or your convection oven cookbook for temperature recommendations.

PRESS

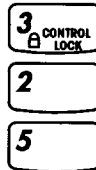

YOU SEE

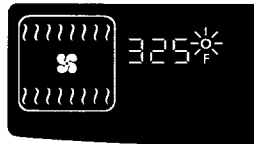

(example shows 325°F temperature setting in Convection Roast)

4. Press Cook Time pad.

PRESS



YOU SEE



(start time display will light up, showing time of day)



Using and Caring for Your Oven

5. Set cook time.

PRESS

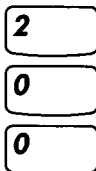

YOU SEE



(example shows 2-hour cook time with stop time now 2 hours later than time of day)

6. Start oven.

Vertical bar on display will get shorter as cook time counts down.

PRESS



YOU SEE



(cook time is displayed)

7. When baking/roasting is done:

“End” will show on the display. Four tones will sound, followed by four short reminder tones every minute until you open the door or press the Cancel/Off pad.

YOU SEE



To delay start and stop automatically:

1. Prepare oven.

Position the oven rack(s) properly and place the food in the oven. For correct rack placement, see “Rack positions” on page 27 and “Rack placement” chart on page 28.

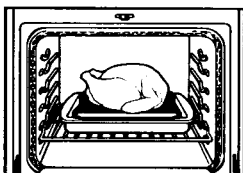

2. Choose cook setting.

- BAKE,
- CONVECTION BAKE, or
- CONVECTION ROAST

PRESS



YOU SEE

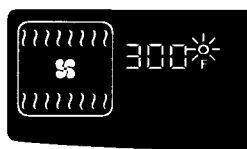

(example for Convection Roast)

3. Set temperature (optional).

Do this step if you want to set a temperature other than the one displayed.

NOTE: See a reliable cookbook or your convection oven cookbook for temperature recommendations.

PRESS



YOU SEE

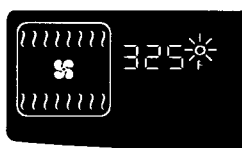

(example shows 325°F temperature setting in Convection Roast)

Using and Caring for Your Oven



4. Press Cook Time pad.

PRESS



YOU SEE



(start time display will light up, showing time of day)

5. Set cook time.

PRESS



YOU SEE



(example shows 2-hour cook time with stop time now 2 hours later than time of day)

6. Press Stop Time pad.

PRESS



YOU SEE

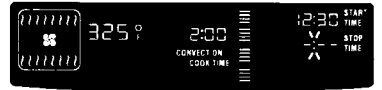

7. Set stop time.

PRESS



YOU SEE



(stop time display shows 3:00 and start time display shows 1:00 – stop time minus 2-hour cook time)

8. Press Start pad.

PRESS



YOU SEE



YOU SEE



When start time is reached:

Vertical bar on display will get shorter as cook time counts down.

9. When baking/roasting is done:

“End” will show on the display. Four tones will sound, followed by four short reminder tones every minute until you open the door or press the Cancel/Off pad.

YOU SEE





Using and Caring for Your Oven

To cancel timed cooking settings:

Press Cancel/Off pad.

PRESS



YOU SEE

(display will go blank)

Dehydrating

You can use your THERMAL-CONVECTION* oven to dehydrate a variety of foods.

NOTE: To learn detailed information about dehydration, refer to a book written specifically about dehydrating and/or preserving foods.

1. Prepare food.

Prepare foods as recommended in recipe.

2. Arrange food on drying racks.

Racks are not included with oven. See below to order a dehydration kit† which includes racks and a spacer or contact a local store handling specialty cookware.

3. Place drying racks in the oven to allow maximum air circulation around the racks.

NUMBER OF RACKS	USE OVEN RACK POSITION
1 rack	3
2 racks	2 and 4
3 racks	1, 3, and 5

4. Position door.

Attach the dehydration spacer†, which is specially designed to depress the oven light plunger and maintain the operation of the fan during dehydration.

The spacer provides a 1 inch gap between the oven frame and the oven door allowing moisture to escape.

† The dehydration spacer (Part No. 814166) or the dehydration kit which includes racks and a spacer (Part No. 4395974) can be ordered from your local KitchenAid dealer, or by calling **1-800-422-1230** and following the instructions and telephone prompts you hear.

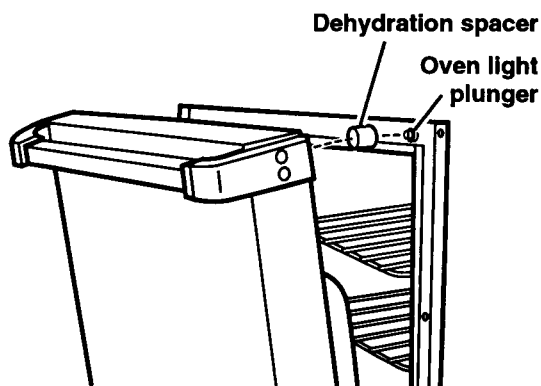

5. Press and hold Convection Bake pad for 5 seconds.

PRESS



Hold for 5 seconds

YOU SEE



6. Set temperature (optional).

Do this step if you want to set a temperature (from 100°F to 200°F) other than 140°F.

NOTE: The 100°F setting will cause "RAISING BREAD" to be displayed. (See below for more information on raising bread.)

PRESS



YOU SEE



(example shows 125°F dehydrating temperature)

7. Start oven.

NOTE: If you want to change the dehydrating temperature after dehydrating has begun, repeat Steps 5, 6, and 7.

PRESS



YOU SEE



8. When dehydrating is done, turn off oven.

PRESS



YOU SEE

(display will go blank)

Raising (proofing) bread

You can use your THERMAL-CONVECTION* oven to proof bread. For more information, see the convection oven cookbook provided with your range.

NOTE: If you do not turn off oven after proofing bread, the oven will keep running until you press CANCEL/OFF.

1. Put dough in oven.

NOTE: Be sure to close the door.

2. Press and hold Baked Goods pad for 5 seconds.

NOTE: If you enter a different temperature, you will enter the Dehydrating mode.

PRESS



Hold for 5 seconds

YOU SEE



continued on next page



Using and Caring for Your Oven

3. Start oven.

One long tone will sound when oven is preheated.

PRESS



YOU SEE



4. When proofing is done, turn off oven.

PRESS



YOU SEE

(display will go blank)

Cleaning your oven and controls



! WARNING

Explosion Hazard

Do not store flammable materials such as gasoline near this appliance.

Doing so can result in death, explosion, fire, or burns.

PART	WHAT TO USE	HOW TO CLEAN
Control knobs	Sponge and warm, soapy water	<ul style="list-style-type: none"> • Turn knobs to OFF and pull straight away from control panel. • Wash, rinse, and dry thoroughly. Do not soak. • Do not use steel wool or abrasive cleansers. They may damage the finish of the knobs. • Replace knobs. Make sure all knobs point to OFF.
Control panel	Sponge and warm, soapy water OR Paper towel and spray glass cleaner	<ul style="list-style-type: none"> • Wash, wipe with clean water, and dry thoroughly. • Do not use steel wool or abrasive cleansers. They may damage the finish. • Do not spray cleaner directly on panel. Apply cleaner to paper towel. <p>NOTE: Set the Control Lock to prevent the oven from accidentally turning on when you are cleaning the panel. (See "Using the control lock" on page 19.)</p>



Using and Caring for Your Oven

PART	WHAT TO USE	HOW TO CLEAN
Exterior surfaces (other than control panel)	Sponge and warm, soapy water	<ul style="list-style-type: none"> • Wash, wipe with clean water, and dry thoroughly. • Use nonabrasive, plastic scrubbing pad on heavily soiled areas. • Do not use abrasive or harsh cleansers. They may damage the finish.
Broiler pan and grid (clean after each use)	Steel-wool pad and warm, soapy water	<ul style="list-style-type: none"> • Wash, rinse, and dry thoroughly. • Do not clean the pan and grid in the Self-Cleaning cycle.
Oven racks	Steel-wool pad and warm, soapy water OR The Self-Cleaning cycle	<ul style="list-style-type: none"> • Wash, rinse, and dry thoroughly. OR <ul style="list-style-type: none"> • Leave in oven during Self-Cleaning cycle. <p>NOTE: Racks will permanently discolor and become harder to slide if left in oven during the Self-Cleaning cycle. Apply a small amount of vegetable oil to the side rungs to aid sliding.</p>
Oven door glass	Paper towel and spray glass cleaner OR Warm, soapy water and a nonabrasive, plastic scrubbing pad	<ul style="list-style-type: none"> • Make sure oven is cool. • Follow directions provided with the cleaner. <ul style="list-style-type: none"> • Wash, wipe with clean water, and dry thoroughly.
Oven cavity	Self-Cleaning cycle	<ul style="list-style-type: none"> • Wipe up food spills containing sugar as soon as possible after the oven cools down. (See “Using the Self-Cleaning Cycle” on page 51.) • See “Using the Self-Cleaning Cycle” on pages 51-54.



Using and Caring for Your Oven

Using and replacing the oven light(s)

Your oven may have a standard oven light or two side halogen lights. The oven light(s) will come on when you open the oven door. To turn the light(s) on when the oven door is closed, **press** the Oven Light pad  on the control panel. **Press** the pad  again to turn off the light(s).

Replacing the oven light (models with light on back wall):

1. **Disconnect** appliance at main power supply. Make sure the oven is cool before replacing the light bulb.

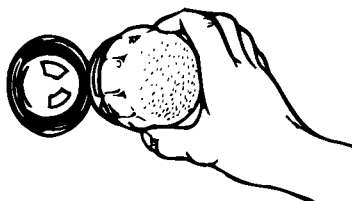

2. **Remove** the glass bulb cover in the back of the oven by screwing it out counter-clockwise.
3. **Remove** the light bulb from its socket. **Replace** the bulb with a 40-watt appliance bulb.
4. **Replace** the bulb cover by screwing it in clockwise. **Reconnect** appliance at main power supply.

NOTE: The oven light will not work during the Self-Cleaning cycle.

Replacing oven lights (models with side halogen lights):

1. **Disconnect** appliance at the main power supply. Make sure the oven is cool before replacing the light bulb.

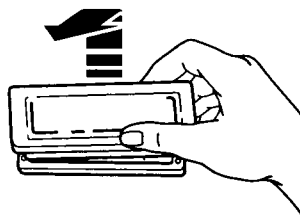

2. **Remove** glass light cover by grasping front edge of cover and pulling it away from the side wall of the oven.
3. **Remove** the light bulb from its socket. **Replace** the bulb with another halogen bulb (12 volt, 5 watt maximum, available at most hardware stores).
4. **Replace** the light cover by snapping it back into wall. **Reconnect** appliance at main power supply.

NOTE: The oven lights will not work during the Self-Cleaning cycle.

Using the Self-Cleaning Cycle

The Self-Cleaning cycle saves you from the toil and mess that often come with hand-cleaning the oven interior. Like the other functions of your oven, you operate the Self-Cleaning cycle with the easy-to-use electronic control. To use this cycle properly, follow the step-by-step instructions in this section.



⚠ WARNING

Burn Hazard

Do not touch the oven during the Self-Cleaning cycle.
Keep children away from oven during Self-Cleaning cycle.
Do not use commercial oven cleaners in your oven.
Failure to follow these instructions can result in burns, or illness from inhaling dangerous fumes.

Before you start

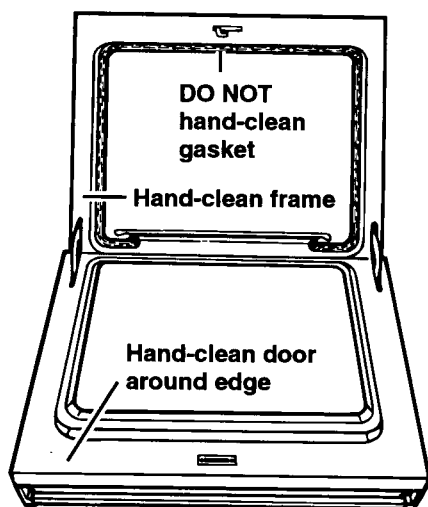

Before you start the Self-Cleaning cycle, make sure you:

- **Hand-clean the areas shown.** They do not get hot enough during the Self-Cleaning cycle for soil to burn away. Use hot water and detergent or a soapy, steel-wool pad for cleaning.
NOTE: DO NOT clean, move, or bend the gasket. Poor cleaning, baking, and roasting may result.
- **Remove** the broiler pan and grid and anything else being stored in the oven.
- **Wipe out** any loose soil or grease. This will help reduce smoke during the Self-Cleaning cycle.

- **Wipe up** food spills containing sugar as soon as possible after the oven cools down. When sugar is heated to a high temperature in the Self-Cleaning cycle, the high temperature can cause the sugar to burn and react with the porcelain. This can cause staining and etching or pitting.
- **Remove** the oven racks from the oven if you want them to remain shiny. You can clean racks in the Self-Cleaning cycle, but they will discolor and become harder to slide. If you clean racks in the Self-Cleaning cycle, place them on the rack guides.
- **Heat and odors** are normal during the Self-Cleaning cycle. Keep the kitchen well ventilated by opening a window or by turning on a vent hood or other kitchen vent during the cycle.

NOTES:

- **Do not block** the vent during the Self-Cleaning cycle. Air must move freely for best cleaning results.
- **Do not leave plastic** utensils on the cooktop. They may melt.
- **Do not leave** any foil in oven during the Self-Cleaning cycle. Foil could burn or melt and damage the oven surface.
- **The oven light** will not work during the Self-Cleaning cycle.
- **The cooktop** will not work during the Self-Cleaning cycle on Canadian models.

Using the Self-Cleaning Cycle

Before setting the controls

- Make sure clock is set to correct time of day.
- Make sure the oven door is completely closed.

Setting the controls

To start cleaning immediately:

1. Press Clean pad.

A 3½-hour Self-Cleaning cycle will be set. (The first 3 hours are for cleaning, the last 30 minutes are for cooling.)

PRESS



YOU SEE



(stop time display shows time 3½ hours later than time of day – shown in start time display)

2. Set cleaning time (optional).

If you want a Self-Cleaning cycle other than 3½ hours, **press** the desired Number pads for the new time up to 4½ hours.

- Use 2½ hours for light soil.
- Use 3½-4½ hours for moderate to heavy soil.

PRESS

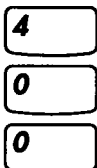

YOU SEE



(example shows 4-hour cleaning cycle with stop time now 4 hours later than time of day)

3. Start oven.

NOTE: The door will lock right after you press START.

PRESS



YOU SEE



4. After the Self-Cleaning cycle ends:

YOU SEE



Using the Self-Cleaning Cycle

To delay cleaning start time:

1. Press Clean pad.

A 3½-hour Self-Cleaning cycle will be set. (The first 3 hours are for cleaning, the last 30 minutes are for cooling.)

PRESS



YOU SEE



(stop time display shows time 3½ hours later than time of day – shown in start time display)

2. Set cleaning time (optional).

If you want a Self-Cleaning cycle other than 3½ hours, **press** the desired Number pads for the new time up to 4½ hours.

- Use 2½ hours for light soil.
- Use 3½-4½ hours for moderate to heavy soil.

PRESS

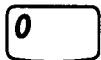
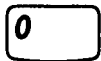
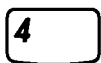

YOU SEE



(example shows 4-hour cleaning cycle with stop time now 4 hours later than time of day)

3. Press Stop Time pad.

PRESS



YOU SEE



4. Set stop time.

Example for 7:00:

PRESS

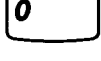
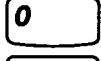

YOU SEE



(display shows stop time of 7:00 and start time of 3:00 – stop time minus cleaning time)

5. Complete entry.

NOTE: The door will lock right after you press START.

PRESS



YOU SEE



When the start time is reached:

YOU SEE



continued on next page

Using the Self-Cleaning Cycle

6. After the Self-Cleaning cycle ends:

YOU SEE

End

To stop the Self-Cleaning cycle at any time:

PRESS

CANCEL
OFF

YOU SEE

End

("DOOR LOCKED" will appear if oven has not cooled down)

For best cleaning results

- After the oven cools to room temperature, wipe up any residue or ash with a damp cloth or sponge. If any spots remain, clean with a mild abrasive cleanser or cleaning sponge.
- Clean the oven before it gets heavily soiled. Cleaning a very soiled oven takes longer and results in more smoke than usual.
- If the Self-Cleaning cycle does not get the oven as clean as you expected, the cycle may not have been set long enough or you may not have prepared the oven properly. Set the Self-Cleaning cycle longer the next time and hand-clean areas noted on page 51.

How the cycle works

The Self-Cleaning cycle uses very high heat to burn away soil and grease. During the cycle, the oven gets much hotter than it does for normal baking or broiling. This high heat breaks up the soil or grease and burns it away.

Your oven is preset for a 3½-hour Self-Cleaning cycle. However, you can adjust the cycle time to the amount of soil in your oven. You can set the cycle anywhere between 2½ and 4½ hours. (See "Setting the controls" on page 52.)

The graph at the right is representative of a normal, 3½-hour Self-Cleaning cycle. Note that the heating stops after 3 hours, but it takes longer for the oven to cool enough to unlock.

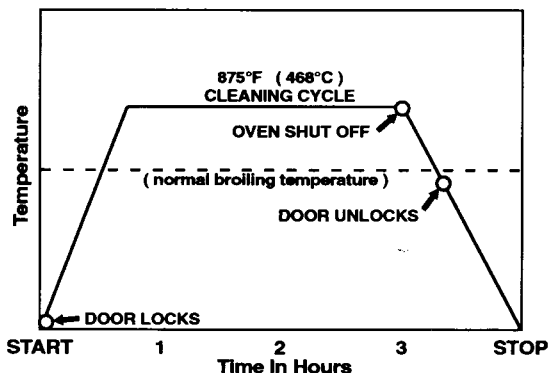

Troubleshooting

Most cooking problems often are caused by little things you can find and fix without tools of any kind. Check the lists below and on the next page before calling for assistance or service. If you still need help, see “Requesting Assistance or Service” on page 57 or 58.

If nothing operates, check the following:

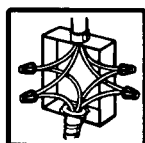

Is the range wired into a live circuit with the proper voltage?
(See Installation Instructions.)

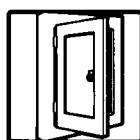

Have you blown a household fuse or tripped a circuit breaker?

Other possible problems and their causes:

PROBLEM	CAUSE
The oven will not operate	<ul style="list-style-type: none"> You have not set the electronic control correctly. Refer to the section in this manual describing the function you are operating. You have programmed a delayed start time. Wait for the start time to be reached or cancel and reset the control.
The surface units will not operate	<ul style="list-style-type: none"> You have blown a household fuse or tripped a circuit breaker. You have not set the control knobs correctly. Push control knobs in before turning to a setting.
The control knob(s) will not turn	<ul style="list-style-type: none"> You are not pushing in before turning.
The Self-Cleaning cycle will not operate	<ul style="list-style-type: none"> You have programmed a delayed start time. Wait for the start time to be reached or cancel and reset the control. The cooling fan is not running. If fan is running, you can hear it. Call a KitchenAid service technician for repair.
Cooking results are not what you expected	<ul style="list-style-type: none"> The range is not level. (See Installation Instructions.) The oven temperature seems too low or too high. See “Adjusting oven temperature” on page 30 to adjust oven temperature. You did not preheat the oven before baking (if called for in recipe).

continued on next page



Troubleshooting

PROBLEM	CAUSE
Cooking results are not what you expected (continued)	<ul style="list-style-type: none">• The recipe you are using may need to be altered to improve the taste or appearance of the food.• You are using a pan that is not the correct type or size. Refer to a reliable cookbook or recipe for recommended pan type and size.• There is not enough air space around pan when baking. Allow 1½ to 2 inches (4-5 cm) of air space on all sides of pan.• The cookware is too large or too small for the surface unit being used. Pan should be the same size or slightly larger than the surface unit being used.
The display is showing "PF"	<ul style="list-style-type: none">• There has been a power failure. Reset the clock. (See page 22.)
A letter followed by a number shows on the display (for example "E3", "F1")	<ul style="list-style-type: none">• Press CANCEL/OFF. If the code does not disappear, call for service. (See Step 2 on page 57 or 58.)
The key pads do not operate	<ul style="list-style-type: none">• The Control Lock has been set. (See "Using the control lock" on page 19.) Turn off the Control Lock by pressing and holding the Control Lock pad (Number Pad 3) for 5 seconds.• The Sabbath mode has been set ("SAbb" appears on the display). Turn off the Sabbath mode by opening the oven door, waiting up to 15 seconds, and pressing and holding Number Pad 6 for 5 seconds.• The range is not grounded. Call the KitchenAid service technician to ground the range.

If none of these items was causing your problem, see "Requesting Assistance or Service" on page 57 or 58.

Requesting Assistance or Service

Before calling for assistance or service, please check the “Troubleshooting” section. It may save you the cost of a service call. If you still need help, follow the instructions below.

If you need assistance or service in the U.S.A.:

1. If the problem is not due to one of the items listed in “Troubleshooting” on pages 55-56†:

- Call the KitchenAid Consumer Assistance Center:



1-800-422-1230

One of our trained consultants can instruct you in how to obtain satisfactory operation from

your appliance or, if service is necessary, recommend a qualified service company in your area.

- If you prefer, write to:

KitchenAid Brand Home Appliances
Consumer Assistance Center
c/o Correspondence Dept.
2000 North M-63
Benton Harbor, MI 49022-2692

Please include a daytime phone number in your correspondence.

2. If you need service†:

- Call your dealer or the repair service he recommends.



- All service should be handled locally by the dealer from whom you purchased the unit or an authorized KitchenAid servicer.

- If you are unable to obtain the name of a local authorized KitchenAid servicer, call our Consumer Assistance Center telephone number (see Step 1).

3. If you are not satisfied with the action taken:

- Contact the Major Appliance Consumer Action Program (MACAP). MACAP is a group of independent consumer experts that voices consumer views at the highest levels of the major appliance industry.
- Contact MACAP only when the dealer, authorized servicer, and KitchenAid have failed to resolve your problem.

Major Appliance Consumer Action Program
20 North Wacker Drive
Chicago, IL 60606

- MACAP will in turn inform us of your action.

† When asking for help or service:

Please provide a detailed description of the problem, your appliance's complete model and serial numbers, and the purchase date. (See page 3.) This information will help us respond properly to your request.



Requesting Assistance or Service

If you need assistance or service in Canada:

1. If the problem is not due to one of the items listed in "Troubleshooting"†...

Contact the dealer from whom you purchased your appliance, or call the KitchenAid Canada Consumer Assistance Centre toll free, **8:30 a.m. – 6 p.m. (EST)**, at **1-800-461-5681**.



Please include a daytime phone number in your correspondence.

2. If you need service†...

Contact your nearest KitchenAid Canada Appliance Service branch or authorized servicing outlet to service your appliance. (See list below.)

† When asking for help or service:

Please provide a detailed description of the problem, your appliance's complete model and serial numbers, and the purchase date. (See page 3.) This information will help us respond properly to your request.

KitchenAid Canada Appliance Service – Consumer Services

Direct service branches:

BRITISH COLUMBIA		1-800-665-6788
ALBERTA		1-800-661-6291
ONTARIO (except 807 area code)	Ottawa area Outside the Ottawa area	1-800-267-3456 1-800-807-6777
MANITOBA, SASKATCHEWAN and 807 area code in ONTARIO		1-800-665-1683
QUEBEC	Montreal (except South Shore) South Shore Montreal Quebec City Sherbrooke	1-800-361-3032 1-800-361-0950 1-800-463-1523 1-800-567-6966
ATLANTIC PROVINCES		1-800-565-1598

For further assistance

If you need further assistance, you can write to KitchenAid Canada with any questions or concerns at:

Please include a daytime phone number in your correspondence.

Consumer Relations Department
KitchenAid Canada
1901 Minnesota Court
Mississauga, Ontario L5N 3A7

Don't forget, KitchenAid offers a full line of quality home appliances.

Built-In Refrigerators	Trash Compactors	Ranges & Cooktops
Freestanding Refrigerators	Hot Water Dispensers	Microwave Ovens
50-Pound Ice Makers	Food Waste Disposers	Washers & Dryers
Dishwashers	Built-In Ovens	Mixers & Blenders

For more information on these appliances, or the one you have purchased, call our toll-free Consumer Assistance Center telephone number, **1-800-422-1230** (in U.S.A.), or contact your authorized KitchenAid Canada Appliance Service branch (in Canada).

Index

This index is alphabetical. It contains all the topics included in this manual, along with the page(s) on which you can find each topic.

<u>TOPIC</u>	<u>PAGE</u>	<u>TOPIC</u>	<u>PAGE</u>
ANTI-TIP BRACKETS	10	Starting	19
ASSISTANCE	57, 58	Timer	22
BAKING		Tones	19
Aluminum foil	28	CONVECT FULL MEAL	33
Pans	27	CONVECTION BAKING	
Setting cycle	24	Pans	27
Tips	27, 28	Setting	24
BROILING		Tips	27, 29
Broil stop position	38	CONVECTION BROILING	40
Chart	42	COOKTOP	
Grid	38	Caring for	14
Pan	38	Cleaning	15
Setting cycle	39	Using	11, 12
Tips	41	COOKWARE	
CLEANING		Canning	13
Cooktop	15	Pans	13
Oven	48, 49	DEHYDRATING	46
Self-cleaning	51	EASY CONVECT* Conversion	36
CONTROL PANEL		FEATURES	7, 8
Canceling	19	LIGHT(S)	
Clock	22	Oven	50
Command pads	18	LOCK	
Control lock	19	Control	19
Display	18	Self-cleaning cycle	52, 53
Number pads	18	MODEL AND SERIAL NUMBER	3
Sabbath feature	20		
Settings	21		
Signals	19		

<u>TOPIC</u>	<u>PAGE</u>	<u>TOPIC</u>	<u>PAGE</u>
OVEN TEMPERATURE		SERVICE	57, 58
Adjusting	30	STORAGE DRAWER	
Setting	24, 26, 30, 32, 39, 41, 43, 44	Removing	9
PARTS	7, 8	Replacing	9
PROOFING BREAD	47	SURFACE UNITS	
RACKS		Ceramic glass cooktop	12, 14, 15
Convection roasting rack	29	Control knobs	7, 8, 48
Placement	28	Control setting guide	11
Positions	27	Dual-size surface unit	12
ROASTING		Hot surface indicator lights	11
Rack	29	Power on lights	11
Setting cycle	24	TEMPERATURE PROBE	
Tips	29	Cleaning	33
SAFETY	4-6	Connecting to oven	31
SELF-CLEANING		Inserting in food	31
Delay cleaning	53	Setting cycle	32
How cycle works	54	TIMED COOKING	
Preparing oven	51	Canceling	46
Setting controls	52, 53	Cook time	43, 45
Starting immediately	52	Stop time	45
Stopping cycle	54	TROUBLESHOOTING	55
Tips	54	WARRANTY	64

KitchenAid*

Electric Range

Warranty

LENGTH OF WARRANTY:	KITCHENAID WILL PAY FOR:	KITCHENAID WILL NOT PAY FOR:
ONE-YEAR FULL WARRANTY FROM DATE OF PURCHASE.	Replacement parts and repair labor costs to correct defects in materials or workmanship. Service must be provided by an authorized KitchenAid servicing outlet.	A. Service calls to: <ol style="list-style-type: none"> 1. Correct the installation of the range. 2. Instruct you how to use the range. 3. Replace house fuses or correct house wiring.
SECOND-THROUGH FIFTH-YEAR LIMITED WARRANTY FROM DATE OF PURCHASE.	Replacement parts for any electric element to correct defects in materials or workmanship. Replacement ceramic glass if breakage is due to defects in materials or workmanship. Replacement parts for solid state touch control system to correct defects in materials or workmanship.	B. Repairs when range is used in other than normal home use. C. Damage resulting from accident, alteration, misuse, abuse, improper installation, or installation not in accordance with local electrical codes. D. Any labor costs during the limited warranties. E. Replacement parts or repair labor costs for units operated outside the United States and Canada. F. Pickup and delivery. This product is designed to be repaired in the home.
SECOND-THROUGH TENTH-YEAR LIMITED WARRANTY FROM DATE OF PURCHASE.	Replacement parts for the porcelain oven cavity/inner door if the part rusts through due to defects in materials or workmanship.	G. Repairs to ceramic glass cooktop if it has not been cared for as recommended in this Use and Care Guide. H. Repairs to parts or systems caused by unauthorized modifications made to the appliance.

7/95

KITCHENAID DOES NOT ASSUME ANY RESPONSIBILITY FOR INCIDENTAL OR CONSEQUENTIAL DAMAGES. Some states or provinces do not allow the exclusion or limitation of incidental or consequential damages, so this exclusion or limitation may not apply to you. This warranty gives you specific legal rights, and you may also have other rights which vary from state to state or province to province.

Outside the United States and Canada, a different warranty may apply. For details, please contact your authorized KitchenAid dealer.

If you need service, first see the "Troubleshooting" section of this book. After checking "Troubleshooting," additional help can be found by checking the "Requesting Assistance or Service" section or by calling our Consumer Assistance Center telephone number, **1-800-422-1230**, from anywhere in the U.S.A. In Canada, call KitchenAid Canada at one of the telephone numbers listed on page 58.

KitchenAid
Benton Harbor, Michigan 49022-2692 U.S.A.