

# use & care guide

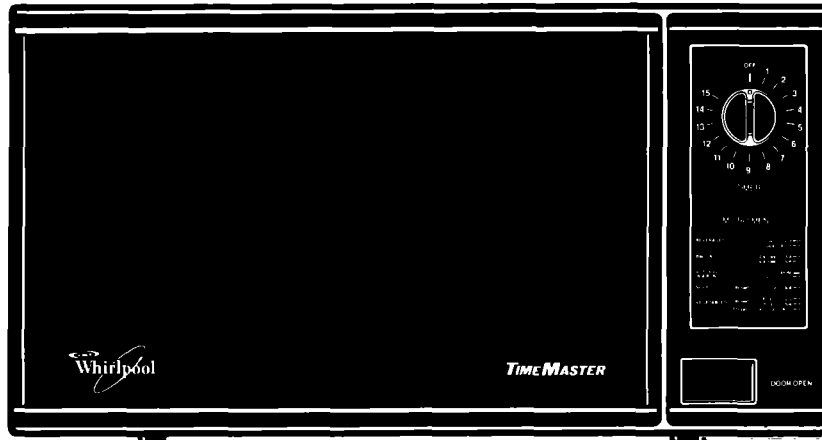

**MICROWAVE  
OVEN**



**Model MW1000XS**

Refrigerators, Freezers, Refrigerator-Freezers, Ice Makers, Dishwashers, Built-In Ovens and Surface Units, Ranges, Microwave Ovens, Trash Compactors, Room Air Conditioners, Dehumidifiers

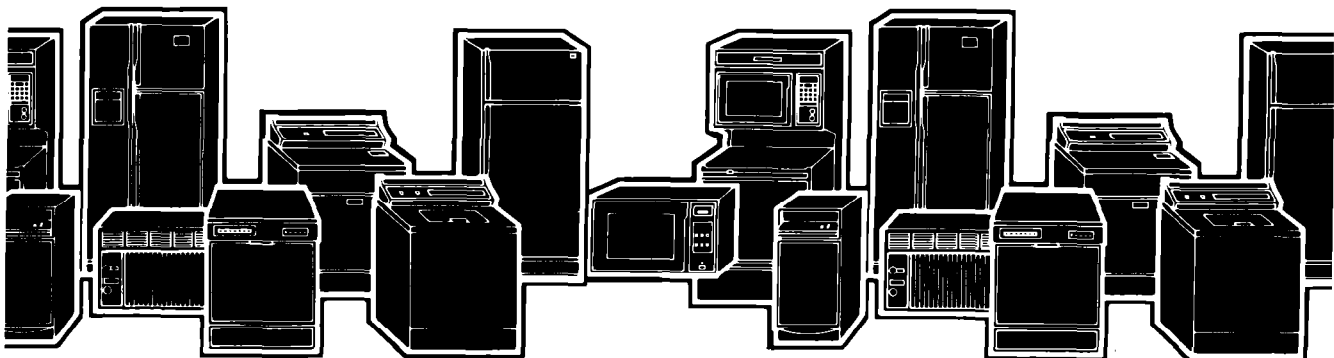

# Contents

	Page		Page
<b>Parts and Features</b> .....	2	Setting the Timer .....	6
<b>Before You Install Your Microwave Oven</b> .....	3	<b>Installation Instructions</b> .....	7
<b>Before You Use Your Microwave Oven.</b> 3		Grounding Instructions .....	8
<b>Precautions to Avoid Possible Exposure to Excessive Microwave Energy</b> .....	3	Custom Mounting Your Microwave Oven .....	9
<b>Important Safety Instructions</b> .....	4	<b>Caring for Your Microwave Oven</b> .....	9
<b>Using Your Microwave Oven</b> .....	5	Cleaning the Microwave Oven .....	9
Microwave Oven Control .....	5	<b>Operating Safety Precautions</b> .....	10
Cooking in Your Microwave Oven ...	5	<b>If You Need Service or Assistance</b> .....	12
		<b>Microwave Oven Warranty</b> .....	16

©1988 Whirlpool Corporation

## Parts and features

### Model MW1000XS

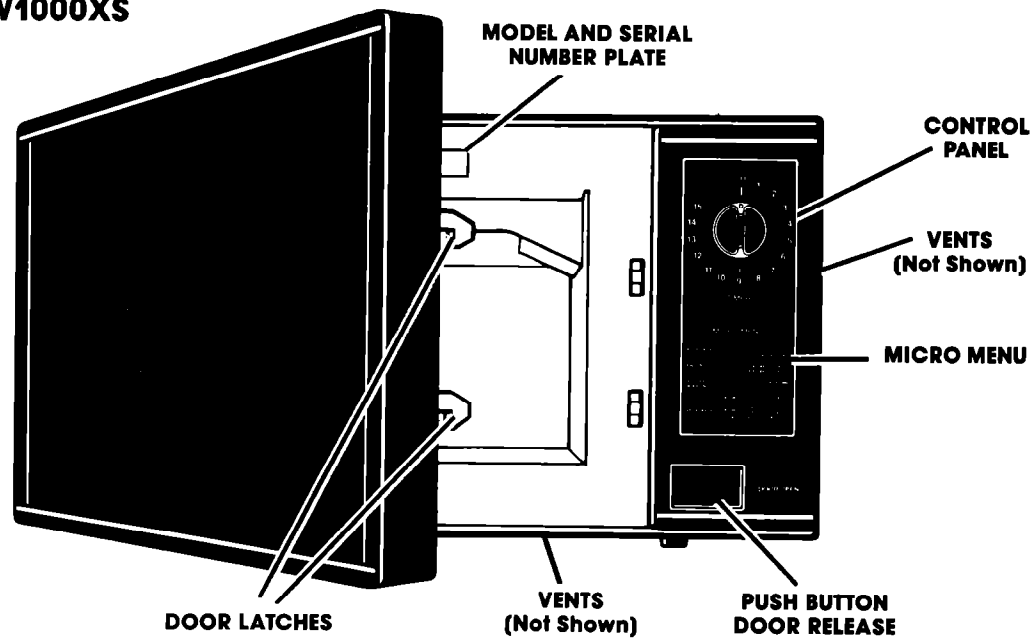

**Thank you for buying a Whirlpool appliance. Please complete and mail the Owner Registration Card provided with this product.** Then complete the form below. Have this information ready if you need service or call with a question.

- Copy Model and Serial Numbers from plate (behind the microwave oven door on the oven frame) and the purchase date from the sales slip.
- Keep this book and your sales slip together in a handy place.

\_\_\_\_\_

**Model Number**

\_\_\_\_\_

**Serial Number**

\_\_\_\_\_

**Purchase Date**

\_\_\_\_\_

**Service Company Phone Number**

Fill out and return the "Microwave Registration Card" included with your oven. If the card is missing, please send the model number and serial number of your microwave oven with your name and address to...

Whirlpool Corporation  
Microwave Registration Department  
Administrative Center  
2000 M-63  
Benton Harbor, Michigan 49022

This information will help us reach you if there is ever a need to pass along information about your microwave oven.

## Before you install your microwave oven

Read and carefully follow the "INSTALLATION INSTRUCTIONS" found on page 7 of this "Use & Care Guide."



**WARNING:** Failure to follow the installation instructions could lead to product malfunction or possible personal injury.

## Before you use your microwave oven

Read this "Use & Care Guide" carefully for important use and safety information. Store in a convenient place for future use.



**It is your personal responsibility and obligations to be sure your microwave oven:**

- Has been installed where it is protected from the weather. **The microwave oven should be at a temperature above 50°F (10°C) for proper operation.**
- Has been installed on a surface strong enough to support its weight.
- Has been properly connected to electrical supply and grounded. (See "Installation Instructions.")
- Is not used by children or anyone unable to operate it properly.
- Is properly maintained.
- Is used only for jobs expected of a home microwave oven.

## PRECAUTIONS TO AVOID POSSIBLE EXPOSURE TO EXCESSIVE MICROWAVE ENERGY...

**DO NOT** attempt to operate this oven with the door open since open-door operation can result in harmful exposure to microwave energy. It is important not to defeat or tamper with the safety interlocks.

**DO NOT** place any object between the oven front face and the door or allow soil or cleaner residue to accumulate on sealing surfaces.

**DO NOT** operate the oven if it is damaged. It is particularly important that the oven door close properly and that there is no damage to the  
(1) Door (bent),  
(2) Hinges and latches (broken or loosened),  
(3) Door seals and sealing surfaces.

**DO NOT** operate the microwave oven if the door window is broken.

The microwave oven should be checked for microwave leakage by qualified service personnel after a repair is made.

The oven should not be adjusted or repaired by anyone except properly qualified service personnel.

**DO NOT** operate the microwave oven with the outer cabinet removed.

# IMPORTANT SAFETY INSTRUCTIONS

Microwave ovens have been thoroughly tested for safe and efficient operation. However, as with any appliance, there are special installation and safety precautions which must be followed to ensure safe and satisfactory operation and prevent damage to the unit.



**WARNING:** To reduce the risk of burns, electric shock, fire, injury to persons or exposure to excessive microwave energy.

1. Read all instructions before using appliance.
2. Read and follow the specific "PRECAUTIONS TO AVOID POSSIBLE EXPOSURE TO EXCESSIVE MICROWAVE ENERGY" found on page 3.
3. This appliance must be grounded. Connect only to properly grounded outlet. See "GROUNDING INSTRUCTIONS" found on page 8.
4. Install or locate this appliance only in accordance with the provided "INSTALLATION INSTRUCTIONS" found on page 7.
5. Some products such as whole eggs and sealed containers – for example, closed glass jars – may explode and should not be heated in this oven.
6. Use this appliance only for its intended use as described in this manual.
7. As with any appliance, close supervision is necessary when used by children.
8. Do not operate this appliance if it has a damaged cord or plug, if it is not working properly, or if it has been damaged or dropped. Electric shock, fire or other hazards may result.
9. This appliance should be serviced only by qualified service personnel. Call a Whirlpool authorized TECH-CARE® Service Company for examination, repair or adjustment.
10. Do not cover or block any opening on the appliance, for fire may result.
11. Do not use outdoors for damage to the oven or electric shock may result.
12. Do not immerse cord or plug in water for electric shock may result.
13. Keep cord away from heated surfaces for electric shock may result.
14. Do not let cord hang over edge of table or counter for electric shock may result.
15. See door surface cleaning instructions on page 9.
16. To reduce the risk of fire in the oven cavity:
  - a. Do not overcook food. Carefully attend appliance if paper, plastics, or other combustible materials are placed inside the oven to facilitate cooking. Paper can char or burn, and some plastics can melt if used when heating foods.
  - b. Test dinnerware or cookware before using. See page 12. Some dishes (melamine, Centura, etc.) absorb microwave energy becoming too hot to handle and slowing cooking times. Remove wire twist-ties from paper or plastic bags before placing bag in oven. Cooking in metal containers can damage the oven. So can containers with hidden metal (twist-ties, foil lining, staples, metallic glaze or trim).
  - c. If materials inside the oven should ignite, keep oven door closed, turn oven off, and disconnect the power cord, or shut off power at the fuse or circuit breaker panel.
17. Read and follow "OPERATING SAFETY PRECAUTIONS" starting on page 10.

**SAVE THESE INSTRUCTIONS**

# Using your microwave oven

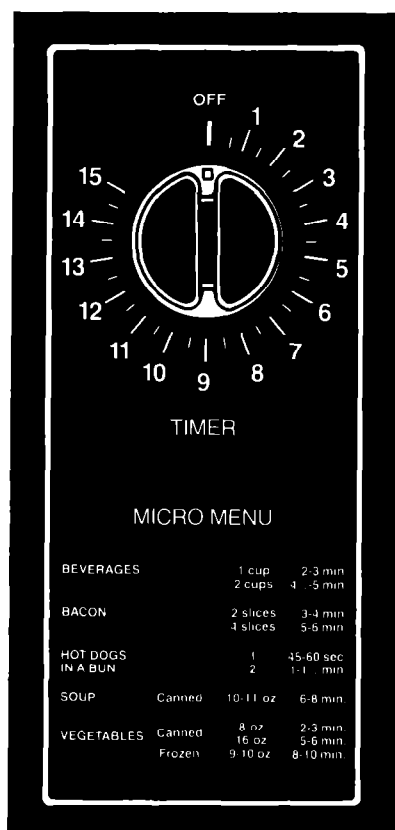

## Microwave oven control

The control section consists of a Timer and a Micro Menu. The Timer is the only oven control. Use of the Timer will be covered on the following pages. Read them carefully.

### The Timer

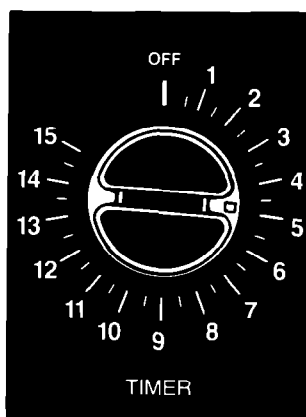

The timer can be set for up to 15 minutes. This controls how long the microwave oven cooks.

## Cooking in your microwave oven

Be sure to read the **MICRO MENUS® Cooking Guide** packed with the microwave oven. It contains information about:

- What is microwave energy?
- How food is cooked by microwave energy.
- What affects cooking speed and cooking evenness.
- Safety tips.
- Utensils to use when cooking in a microwave oven.
- Cooking times for different foods.

The **MICRO MENUS® Cooking Guide** will help you get the **BEST COOKING RESULTS**.

### Important things to remember to get the best cooking results.

- **ALWAYS** cook food for the minimum recommended cooking time. If necessary, add time in one or two minute periods, then check for doneness to avoid overcooking the food.
- Stir, turn or rearrange the food being cooked about halfway through the cooking time for most even doneness with all recipes.
- If a glass cover is not available, use waxpaper, paper towels or a microwave approved plastic wrap. Turn back corner to vent steam during cooking.
- When using microwave recipes from cookbooks or sources other than the **MICRO MENUS® Cooking Guide**, slightly longer cooking times will be needed. For example, add 1 to 2 minutes to a 5 minute cooking time.

## Setting the timer

Be sure you understand the basics of microwave oven cooking before you start. Start with recipes from your MICRO MENUS® Cooking Guide. Follow the directions carefully.

### **DO THIS...**

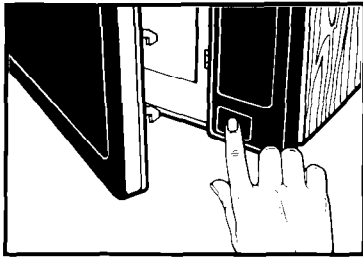

- 1.** Open the oven door by pressing the DOOR OPEN Button on the bottom of the control panel.

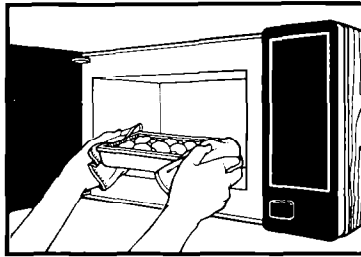

- 2.** Put food in the oven. **DO NOT CLOSE THE DOOR.**

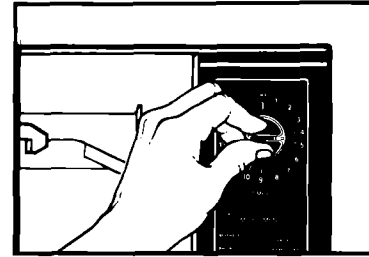

- 3.** Set the cooking time by turning the Timer Knob clockwise. To reduce the cooking time, turn the Timer Knob counterclockwise.  
**To set timer for less than 1 minute, turn timer past 1 minute then to desired time.**

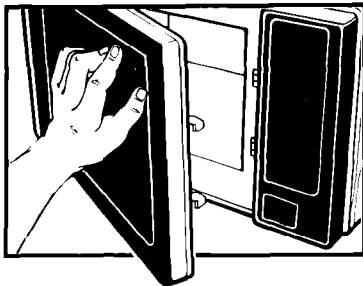

- 4.** Close the door. The oven will start cooking. You will hear a fan running during oven operation.

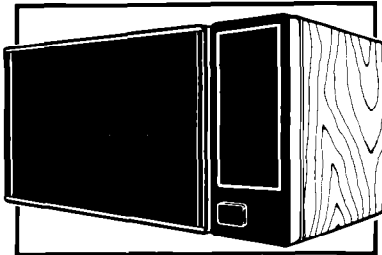

- 5.** When the set time is up, the oven will shut off automatically. The fan will stop running.

### **To stop the oven**

- 1.** Turn the Timer Knob counterclockwise to "0".  
**OR**

- 2.** Open the oven door. Opening the oven door stops the oven so you can stir, turn, rearrange or add ingredients to the food. Close the oven door to complete cooking.  
If you remove the food, set the timer to "0" before closing the oven door so it will not operate.

### **Defrosting in your microwave oven**

Refer to your MICRO MENUS® Cooking Guide for special instructions for defrosting different types of meat.

# Installation instructions

**BEFORE YOU BEGIN, READ THE FOLLOWING INSTRUCTIONS COMPLETELY AND CAREFULLY.**

## Installing your microwave oven

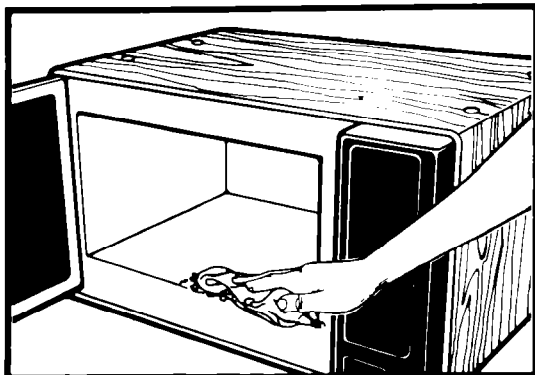

**1.** Empty the microwave oven and clean inside it with a soft, damp cloth. Check for damage such as misaligned door. Damage around the door or dents inside the oven or on the exterior. If there is any damage, **do not** operate the unit until it has been checked by an authorized Whirlpool service technician and any repairs made.

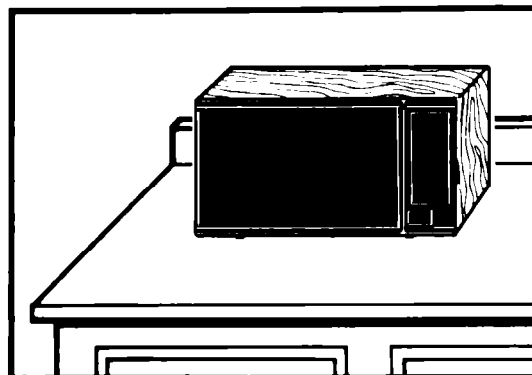

**2.** Put the oven on a cart, counter, table or shelf that is strong enough to hold the oven and the food and utensils you put in it. **(The control side of the unit is the heavy side. Use care when handling.)** The weight of the oven is approximately 34 lbs. (15.3 kg.).

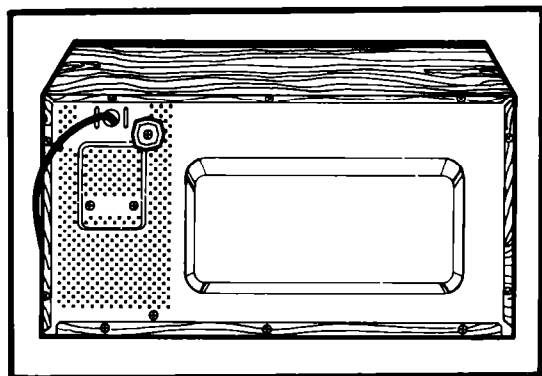

**3.** Do not block the vent or air intake openings on the rear of the oven. Blocking vent or air intake openings can cause damage to the oven and poor cooking results. Make sure the microwave oven legs are in place to ensure proper air flow.

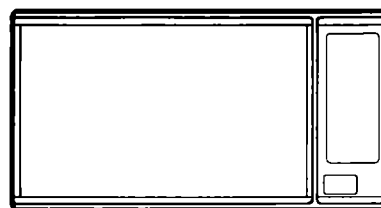

**4.** Do not install the microwave oven so that any part of it is flush with a wall, shelf or cabinet. Leave a total clearance of at least 5 in. (12.7 cm) around the oven for proper operation.

**Do not install the oven next to or over a conventional surface unit or in any area where excessive heat and steam are generated. This could damage the microwave oven.**

## 5. Electrical requirements

### Observe all governing codes and ordinances.

A 120 Volt, 60 Hz, AC only, 15 amp fused electrical supply is required. (Time-delay fuse is recommended.) It is recommended that a separate circuit serving only this appliance be provided.

## 6. GROUNDING INSTRUCTIONS

**⚠ WARNING: Improper use of the grounding plug can result in a risk of electrical shock. DO NOT, UNDER ANY CIRCUMSTANCES, REMOVE THE POWER SUPPLY CORD GROUNDING PRONG.**

7. For your personal safety, this appliance must be grounded. In the event of an electrical short circuit, grounding reduces the risk of electric shock by providing an escape wire for the electric current. This appliance is equipped with a polarized 3-prong grounding plug. It must be plugged into a correctly polarized mating 3-prong grounding type wall receptacle, properly installed and grounded in accordance with the National Electrical Code and local codes and ordinances. If a mating wall receptacle is not available or if you are not sure if the

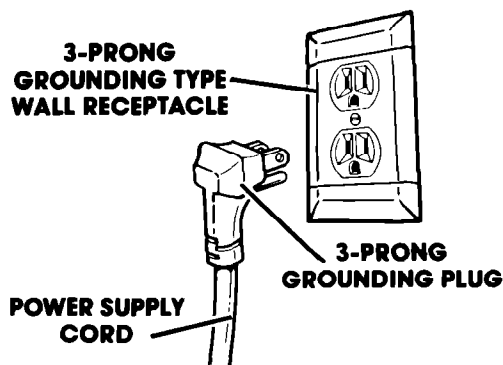

wall receptacle is properly grounded and polarized, have it checked by a qualified electrician.

It is the personal responsibility and obligation of the customer to have a properly grounded and correctly polarized 3-prong wall receptacle installed by a qualified electrician.

Consult a qualified electrician if the grounding instructions are not completely understood, or if doubt exists as to whether the appliance is properly grounded.

**It is NOT recommended to use an extension cord with your microwave oven, but if you find it necessary to do so temporarily (until a properly grounded and polarized 3-prong receptacle is installed), use only a heavy duty UL listed 3 wire grounding type extension cord containing three 16 gauge (minimum) copper wires. It must not be longer than 10 feet (cords longer than 10 feet may affect the cooking performance of your microwave oven). The plug on the extension cord must fit into a 3-prong grounding type wall receptacle (as shown on this page) and the receptacle end of the extension cord must accept the 3-prong grounding plug of the microwave oven.**



8. To test the oven, plug it into the proper electrical outlet. Put about one cup (250mL) of cold water in a glass container in the oven. Close the door. Make sure it latches. Follow the directions on page 6 to set the oven to COOK for 2 minutes. When the time is up, the water should be heated.

9. This microwave oven is designed for use in the household only and must not be used for commercial purposes.

**DO NOT** remove the door, control panel, or cabinet at any time. The unit is equipped with high voltage and should not be serviced unless by an authorized Whirlpool trained service technician.

## SAVE THESE INSTRUCTIONS



## Custom mounting your microwave oven

Your microwave oven is not limited to carts, counters or tables. Custom installations are made easy with kits available from your dealer.

1. Attach the microwave oven to the wall.  
4158002  
Wall Mounting Kit
2. Attach the microwave oven directly to the underside of a cabinet.  
4158231  
Under-the-Cabinet Mounting Kit

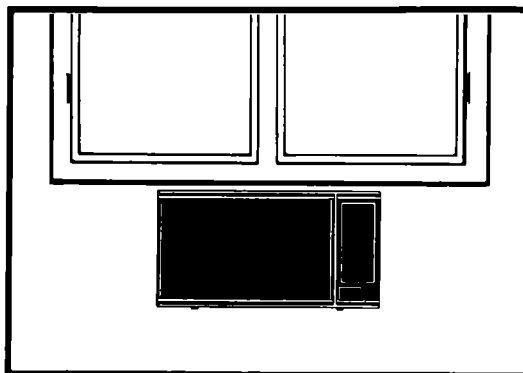

**Do not install the oven next to or over a conventional surface unit or in any area where excessive heat and steam are generated. This could damage the microwave oven.**

## Caring for your microwave oven

### Cleaning the microwave oven

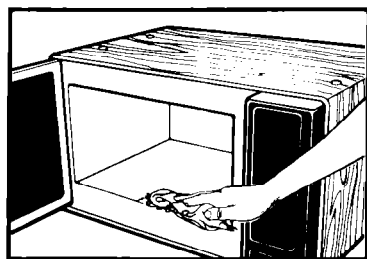

Wipe often with warm sudsy water and a soft cloth or sponge.

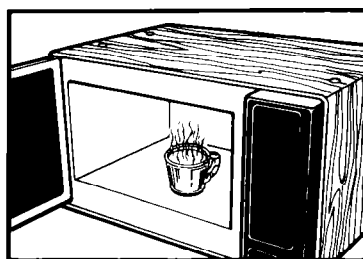

For stubborn soil, boil a cup of water in the oven for 2 or 3 minutes. Steam will soften the soil.

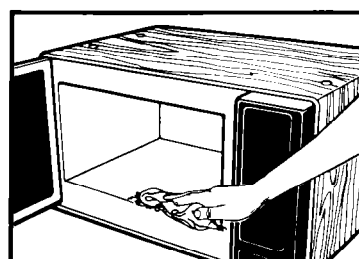

**Be sure to keep the areas clean where the door and oven frame touch when closed.** Use only mild, non-abrasive soaps or detergents applied with a sponge or soft cloth when cleaning surfaces of door and oven that come together. Rinse well.

**CAUTION:**

**Abrasive cleansers, steel wool pads, gritty wash clothes, etc., can damage the control panel, and the interior and exterior oven surfaces. Use a soft cloth or a sponge with a mild detergent or spray glass cleaner.**

# Operating safety precautions



**WARNING: DO NOT** use the oven until you have read and understand **ALL** the information on safe use.

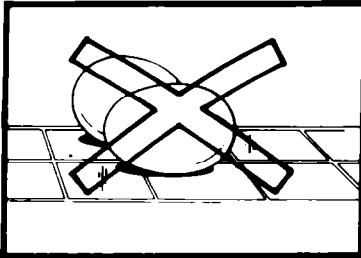

## **NEVER COOK OR REHEAT A WHOLE EGG.**

Steam build-up in whole eggs may cause them to burst and burn you, and possibly damage the oven. Slice hard boiled eggs before heating. In rare instances, poached eggs have been known to explode. Cover poached eggs and allow a standing time of one minute before cutting into them.

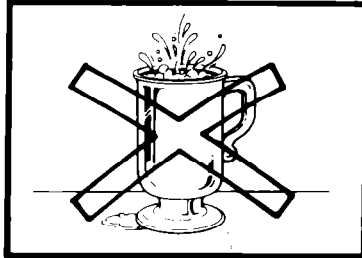

**ALWAYS** use care when heating liquids or adding ingredients to heated liquids. Liquids heated in certain shaped containers may become overheated. The liquid may splash out with a loud noise during or after heating or when adding ingredients (instant coffee, etc.). This can harm the oven and the hot liquid could burn you. Do not use such containers to heat liquids again.

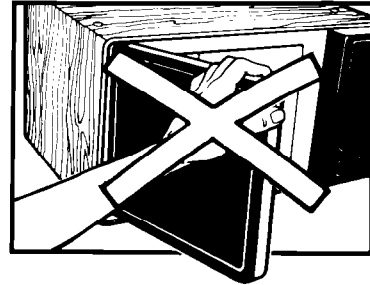

**NEVER** lean on the door or allow a child to swing on it when the door is open. Injury could result.

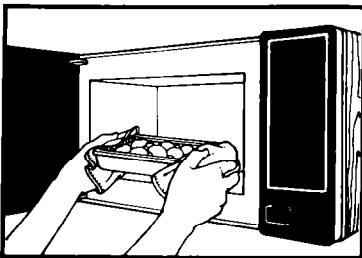

## **USE HOT PADS.**

Microwave energy does not heat containers, but the hot food does. You could get burned.

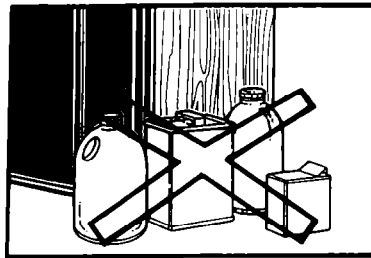

**DO NOT** heat, store or use flammable, inflammable or corrosive materials in or near the oven.

**DO NOT** can foods in the oven. Closed glass jars may explode resulting in damage to the oven or possible personal injury.

**DO NOT** use the oven to sterilize objects (baby bottles, etc.). It is difficult to maintain the high temperature required for safe sterilization.

**CAUTION: DO NOT use the oven until you have read and understood ALL precautions to prevent damage to the oven.**

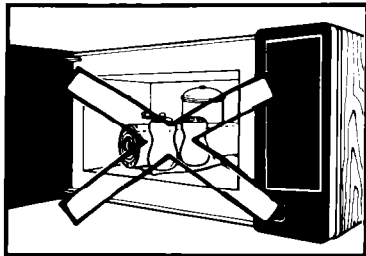

**DO NOT** use the oven for storage. Do not leave paper products, book or cooking utensils in the oven when not in use. Fire may result if someone accidentally starts the oven. Don't let anything touch the top of the oven.

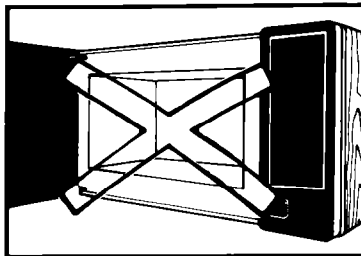

Starting a microwave oven when it's empty is not recommended. If you experiment, put a container of water in the oven.

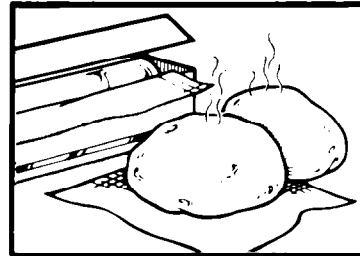

**DO NOT OVERCOOK POTATOES.** Fire could result. At the end of the recommended cooking time they should be slightly firm. Wrap in foil and set aside for 5 minutes. They will finish cooking while standing.

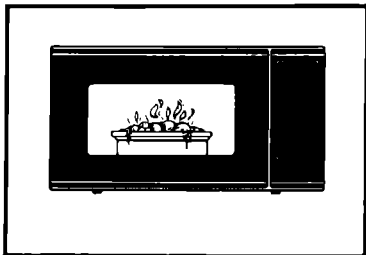

If a fire should start in the oven cavity:

- **keep door closed**
- **turn oven off**
- **disconnect the power supply** at the cord, fuse or circuit breaker.

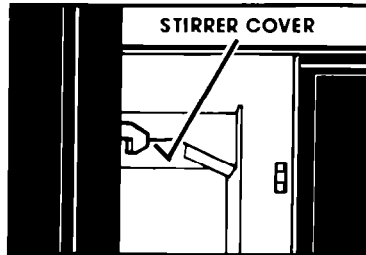

**NEVER** remove the stirrer cover. The plastic cover protects the microwave stirrer blade from soil or bending.

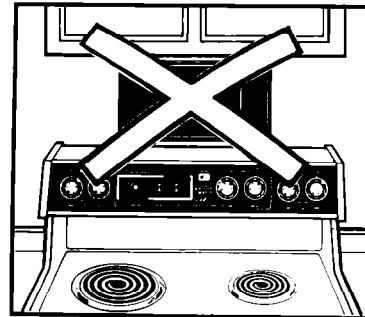

**DO NOT** mount this oven over a cooktop or range. Damage to the oven may result.

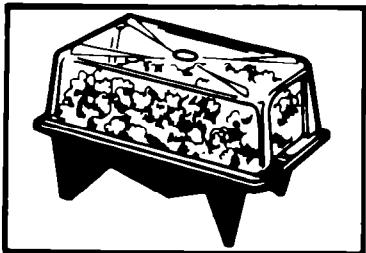

**DO NOT** pop popcorn, except in a microwave-approved popcorn popper or commercial package designed especially for microwave ovens. Results are the manufacturers responsibility. **NEVER** try to pop corn in a paper bag. Overcooking may result in smoke and fire.

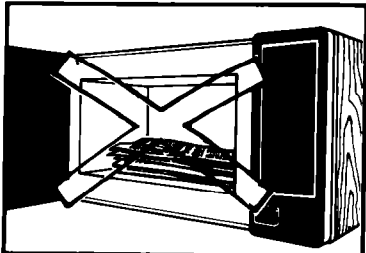

**DO NOT** use newspaper or other printed paper in the oven. Fire could result. **DO NOT** dry flowers, fruit, herbs, wood, paper, gourds or clothes in the oven. Fire or other hazards may result.

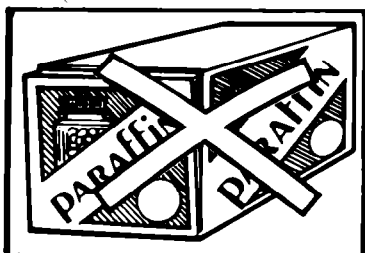

**DO NOT** try to melt paraffin wax in the oven. Fire or other hazards may result.

continued on next page

## General Information

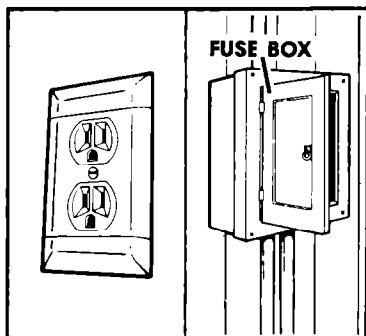

If your electric power line or outlet voltage is less than normal 120 volts, cooking times may be longer.

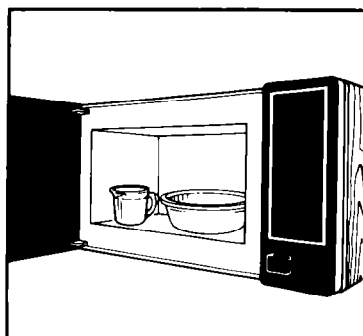

To test a dish for safe use, put it into the oven with a cup of water **beside it.** Cook on high Cook Power for one minute. **If the dish gets hot and water stays cool, do not use it.**

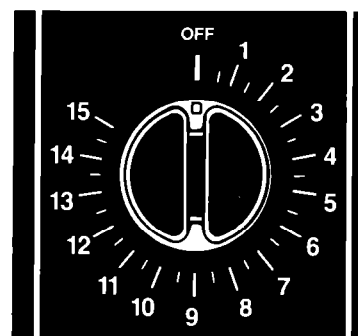

If time is left on the timer when you remove food from the oven, turn the timer to "OFF" before closing the door. This prevents the oven from operating.

---

## If you need service or assistance, we suggest you follow these four steps:

### 1. Before calling for assistance...

Performance problems often result from little things you can find and fix yourself without tools of any kind.

#### If nothing operates:

- Is the oven correctly plugged into a live circuit with the proper voltage? (See page 8.)
- Have you checked your home's main fuses or circuit breaker box?
- Have you checked the electric company for a power failure?

#### If the microwave oven will not run:

- Is the timer set?
- Is the door firmly closed and latched?
- Did you follow the directions exactly?

#### If microwave cooking times seem too long:

- Is the electric supply to your home low or lower than normal? Your electric company can tell you if the line voltage is low.

#### If the microwave cooking times seem too long:

- Is the electric supply to your home or wall outlets low or lower than normal? Your electric company can tell you if the line voltage is low. Your electrician or service technician can tell you if the outlet voltage is low.
- Are you allowing more time when cooking more than one food item?

#### If the fan seems to be running slower than usual:

- Has the oven been stored in a cold area? The fan will run slower until the oven warms up to normal room temperature.

### 2. If you need assistance\*...

**Call Whirlpool COOL-LINE® service assistance telephone number. Dial free from anywhere in the U.S.:**

**1-800-253-1301**

and talk with one of our trained Consultants. The Consultants can instruct you in how to obtain satisfactory operation from your appliance or, if service is necessary, recommend a qualified service company in your area.

### 3. If you need service\*...



Whirlpool has a nationwide network of franchised TECH-CARE® service Companies. TECH-CARE service technicians are trained to fulfill the product warranty and provide after-

warranty service, anywhere in the United States. To locate TECH-CARE service in your area, call our COOL-LINE service assistance telephone number (see Step 2) or look in your telephone directory Yellow Pages under:

**APPLIANCES - HOUSEHOLD -  
MAJOR - SERVICE & REPAIR**

WHIRLPOOL APPLIANCES  
FRANCHISED TECH-CARE SERVICE

*SERVICE COMPANIES*  
XYZ SERVICE CO  
123 MAPLE . . . . . 999-9999

**ELECTRICAL APPLIANCES -  
MAJOR - REPAIRING & PARTS**

**OR**

WHIRLPOOL APPLIANCES  
FRANCHISED TECH-CARE SERVICE

*SERVICE COMPANIES*  
XYZ SERVICE CO  
123 MAPLE . . . . . 999-9999

**OR**

**WASHING MACHINES, DRYERS  
& IRONERS - SERVICING**

WHIRLPOOL APPLIANCES  
FRANCHISED TECH-CARE SERVICE

*SERVICE COMPANIES*  
XYZ SERVICE CO  
123 MAPLE . . . . . 999-9999

### 4. If you have a problem\*...

Call our COOL-LINE service assistance telephone number (see Step 2) and talk with one of our Consultants, or if you prefer, write to:

Mr. Donald Skinner  
Director of Customer Relations  
Whirlpool Corporation  
2000 M-63  
Benton Harbor, MI 49022

\* If you must call or write, please provide: model number, serial number, date of purchase, and a complete description of the problem. This information is needed in order to better respond to your request for assistance.

IF YOU NEED SERVICE OR ASSISTANCE





# WHIRLPOOL® MICROWAVE OVEN/ RANGE PRODUCT WARRANTY

**MW002**

LENGTH OF WARRANTY	WHIRLPOOL WILL PAY FOR
<b>FULL ONE-YEAR WARRANTY</b> From Date of Purchase	FSP® replacement parts and repair labor to correct defects in materials or workmanship. Service must be provided by a franchised TECH-CARE® service company.
<b>LIMITED FOUR-YEAR WARRANTY</b> Second Through Fifth Year From Date of Purchase	FSP® replacement magnetron tube on microwave ovens if defective in materials or workmanship.
<b>WHIRLPOOL WILL NOT PAY FOR</b>	
<p><b>A. Service calls to:</b></p> <ol style="list-style-type: none"> <li>1. Correct the installation of the range product.</li> <li>2. Instruct you how to use the range product.</li> <li>3. Replace house fuses or correct house wiring or plumbing.</li> <li>4. Replace owner accessible light bulbs.</li> </ol> <p><b>B. Repairs when range product is used in other than normal, single-family household use.</b></p> <p><b>C. Pick up and delivery. This product is designed to be repaired in the home.</b></p> <p><b>D. Damage to range product caused by accident, misuse, fire, flood, acts of God or use of products not approved by Whirlpool.</b></p> <p><b>E. Any labor costs during the limited warranty.</b></p>	

WHIRLPOOL CORPORATION SHALL NOT BE LIABLE FOR INCIDENTAL OR CONSEQUENTIAL DAMAGES. Some states do not allow the exclusion or limitation of incidental or consequential damages so this limitation or exclusion may not apply to you. This warranty gives you specific legal rights, and you may also have other rights which vary from state to state.

Outside the United States, a different warranty may apply. For details, please contact your franchised Whirlpool distributor or military exchange.



Part No. 4B73390A/4158259  
©1988 Whirlpool Corporation

Whirlpool Corporation, 2700 Erie Avenue, Dayton, Ohio 45424-0995. Product Lines: REFRIGERATORS, FREEZERS, CUPBOARD APPLIANCES, PERSONAL CARE, WASHING MACHINES, DRYERS, DISHWASHERS, RANGE MAKERS, DISHWASHERS, BUILT-IN OVENS and SURFACE UNITS, RANGES, MICROWAVE OVENS, TRASH COMPACTORS, ROOM AIR CONDITIONERS, DEHUMIDIFIERS, AUTOMATIC WASHERS, CLOTHES I

