

Use and Care Guide



TO THE INSTALLER: PLEASE LEAVE THIS INSTRUCTION BOOK WITH THE UNIT.
TO THE CONSUMER: PLEASE READ AND KEEP THIS BOOK FOR FUTURE REFERENCE.

KitchenAid®
FOR THE WAY IT'S MADE.™

Table of Contents (complete)	2
A Note to You	3
Range Safety	4-7
Getting to Know Your Range	8
Using and Caring for Your Cooktop	12
Using and Caring for Your Oven	21
Using EASY CONVECT™ Conversion	39
Using the Self-Cleaning Cycle	54
Troubleshooting	58
Requesting Assistance or Service	61
Index	62
Warranty	64

1-800-422-1230

Call us with questions or comments.

KITCHENAID® THERMAL-CONVECTION™
Gas Freestanding and Slide-In Ranges

Models: KGRT507B KGST307B

Table of Contents

A Note to You	3	Adjusting oven temperature	33
Range Safety	4-7	Using the temperature probe	34
Getting to Know Your Range	8	Using CONVECT FULL MEAL	37
Feature locations	8	Using EASY CONVECT™	
The oven vent	10	Conversion	39
The storage drawer	10	Broiling	41
The anti-tip bracket	11	Convection broiling	43
Using and Caring for Your Cooktop	12	Timed cooking	46
Using the surface burners	12	Dehydrating	49
Energy saving tips	15	Raising (proofing) bread	51
Cookware tips	15	Cleaning your oven and controls	52
Caring for your cooktop	16	Using and replacing the oven light(s) ...	53
Using and replacing the		Using the Self-Cleaning Cycle	54
surface light	19	Before you start	54
Using and Caring for Your Oven	21	Before setting the controls	55
Using the electronic oven control	21	Setting the controls	55
Oven settings	24	For best cleaning results	57
Setting the clock	25	How the cycle works	57
Using the timer	26	Troubleshooting	58
Baking or convection baking	27	Requesting Assistance or Service	61
Roasting	29	Index	62
Cooking tips	30	Warranty	64

A Note to You

Thank you for buying a KITCHENAID® appliance!

KitchenAid designs the best tools for the most important room in your house. To ensure that you enjoy many years of trouble-free operation, we developed this Use and Care Guide. It contains valuable information concerning how to operate and maintain your new appliance properly and safely. Please read it carefully.

Also, please complete and mail the enclosed Product Registration Card.

Please record your model's information.

Whenever you call our Consumer Assistance Center at **1-800-422-1230** or request service for your appliance, you need to know your complete model number and serial number. You can find this information on the model and serial number plate (see diagrams on pages 8 and 9 for location of plate).

Please also record the purchase information.

NOTE: You must provide proof of purchase or installation date for in-warranty service.

Keep this book and the sales slip together in a safe place for future reference.

Model Number _____

Serial Number _____

**Purchase/
Installation Date** _____

Builder/Dealer _____

Name _____

Address _____

Phone _____

Range Safety

Your safety is important to us.

This guide contains safety symbols and statements. Please pay special attention to these symbols and follow any instructions given. Here is a brief explanation of the use of the symbol.



This symbol alerts you to hazards such as fire, electrical shock, or other injuries.

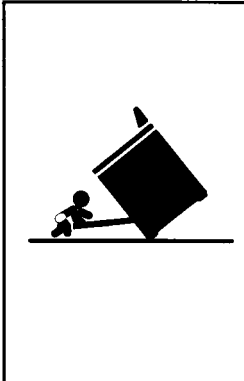

!WARNING

Tip Over Hazard

- Connect anti-tip bracket to the range.**
- Reconnect anti-tip bracket, if the range is moved.**
- Do not push down on the open oven door.**
- Follow the Installation Instructions.**
- Do not let children climb onto the oven door.**
- Failure to follow these instructions can result in death, burns, or other injury.**

IMPORTANT SAFETY INSTRUCTIONS

READ AND SAVE THESE INSTRUCTIONS

Gas ranges have been thoroughly tested for safe and efficient operation. However, as with any appliance, there are specific installation and safety precautions which must be followed to ensure safe and satisfactory operation.

WARNING: If the information in this manual is not followed exactly, a fire or explosion may result causing property damage, personal injury or death.

– Do not store or use gasoline or other flammable vapors and liquids in the vicinity of this or any other appliance.

– WHAT TO DO IF YOU SMELL GAS

- Do not try to light any appliance.**
 - Do not touch any electrical switch; do not use any phone in your building.**
 - Immediately call your gas supplier from a neighbor's phone. Follow the gas supplier's instructions.**
 - If you cannot reach your gas supplier, call the fire department.**
- Installation and service must be performed by a qualified installer, service agency or the gas supplier.**

Range Safety

General

- Install or locate the range only in accordance with the provided Installation Instructions. The range must be installed by a qualified installer. The range must be properly connected to the proper gas supply and checked for leaks. The range must also be properly connected to electrical supply and grounded.
 - Gas fuels and their use in appliances could cause minor exposures to benzene, formaldehyde, carbon monoxide, and soot, primarily from incomplete combustion. Significant exposure to these substances could cause cancer or reproductive harm. Properly adjusted burners with a blue, rather than a yellow, flame will minimize incomplete combustion. Venting with a hood or an open window will further minimize exposure.
 - **WARNING:** To reduce the risk of tipping the appliance, the appliance must be secured by a properly installed anti-tip bracket. To check if the bracket is installed properly, see "The anti-tip bracket" on page 11.
 - **CAUTION:** Do not store things children might want above the range. Children could be burned or injured while climbing on it.
 - Do not leave children alone or unattended in area where the range is in use. They should never be allowed to sit or stand on any part of the range. They could be burned or injured.
 - Do not operate the range if it is damaged or not working properly.
 - Do not use the range for warming or heating the room. Persons could be burned or injured, or a fire could start.
- Do not attempt to light the oven burner during a power failure. Personal injury could result. Reset oven controls to the off position in the event of a power failure.
 - Use the range only for its intended use as described in this manual.



- Do not touch surface burners, areas near burners, or interior surfaces of oven. Areas near surface burners and interior surfaces of an oven become hot enough to cause burns. During and after use, do not touch, or let clothing or other flammable materials contact surface burners, areas near burners, or interior surfaces of oven until they have had sufficient time to cool. Other surfaces of the range, such as the oven vent opening, the surface near the vent opening, the cooktop, and the oven door and window, could also become hot enough to cause burns.



- Do not wear loose or hanging garments when using the range. They could ignite if they touch an open flame and you could be burned.

continued on next page

Range Safety

- Use only dry pot holders. Moist or damp pot holders on hot surfaces could result in burns from steam. Do not let pot holder touch an open flame. Do not use a towel or bulky cloth for a pot holder. It could catch on fire.
- Keep range vents unobstructed.
- Do not heat unopened containers. They could explode. The hot contents could cause burns and container particles could cause injury.
- Use only cookware approved for oven use. Follow cookware manufacturer's instructions, especially when using glass or plastic cookware.
- Do not store flammable materials on or near the range. The fumes could create an explosion and/or fire hazard.
- Do not use the oven for storage.
- Do not use aluminum foil to line area around surface burner, oven bottom, or any other part of the range. Use aluminum foil only as recommended in this manual.
- Do not repair or replace any part of the range unless specifically recommended in this manual. All other servicing should be referred to a qualified technician.
- Any additions, changes, or conversions required in order for this appliance to satisfactorily meet the application needs must be made by a KitchenAid servicer or qualified agency.
- Disconnect the electrical supply and the gas supply at the shutoff valve near range before servicing the range.

When using the cooktop

- Make sure the cookware you use is large enough to contain food and avoid boilovers and spillovers. Heavy splattering or spillovers left on a cooktop could ignite and burn you. Pan size is especially important in deep fat frying.
- Check to be sure glass cookware is safe for use on the range. Only certain types of glass, glass-ceramic, ceramic, earthenware, or other glazed cookware are suitable for cooktops without breaking due to the sudden change in temperature.
- Never leave surface burners unattended at high heat settings. A boilover could result and cause smoking and greasy spillovers that could ignite.



- Turn pan handles inward, but not over other surface burners. This will help reduce the chance of burns, igniting of flammable materials, and spills due to bumping of the pan.
- Do not use decorative covers or trivets over the surface burners.
- Grease is flammable. Do not allow grease to collect around cooktop or in vent. Wipe spillovers immediately.

Range Safety



- Do not use water on grease fires. Never pick up a flaming pan. Smother flaming pan on range by covering with a well-fitting lid, cookie sheet, or flat tray. Flaming grease outside of pan can be extinguished with baking soda or, if available, a multipurpose dry chemical or foam-type extinguisher.
- Never use a match or other flame to look for a gas leak. Explosion and injury could result.
- Know where your main gas shutoff valve is located.

When using the oven

- Always position oven rack(s) in desired location while oven is cool.
- Use care when opening oven door. Let hot air or steam escape before removing or replacing food.
- Small amounts of formaldehyde and carbon monoxide are given off in the Self-Cleaning cycle from fiberglass insulation and food decomposition. Significant exposure to these substances could cause cancer or reproductive harm. Exposure can be minimized by venting with a hood or open window and wiping out excess food spills prior to self-cleaning.



- Do not use oven cleaners. No commercial oven cleaner or oven liner protective coating of any kind should be used in or around any part of the oven.
- Before self-cleaning the oven, remove broiler pan, broiler grid, oven racks, and other cookware. Do not use your oven to clean miscellaneous parts unless you are instructed to do so in this Use and Care Guide.
- Do not clean door gasket. It is essential for a good seal. Care should be taken not to rub, damage, or move the gasket. Clean only parts recommended in this Use and Care Guide.

– SAVE THESE INSTRUCTIONS –

Getting to Know Your Range

This section tells you what features your range has and where they are located. It also discusses some convenience features that you should know about, but which are not needed to operate the range. Please review this information before using your range. To help you find information on specific parts or features quickly, page references are included.

Feature locations

Model KGST307B

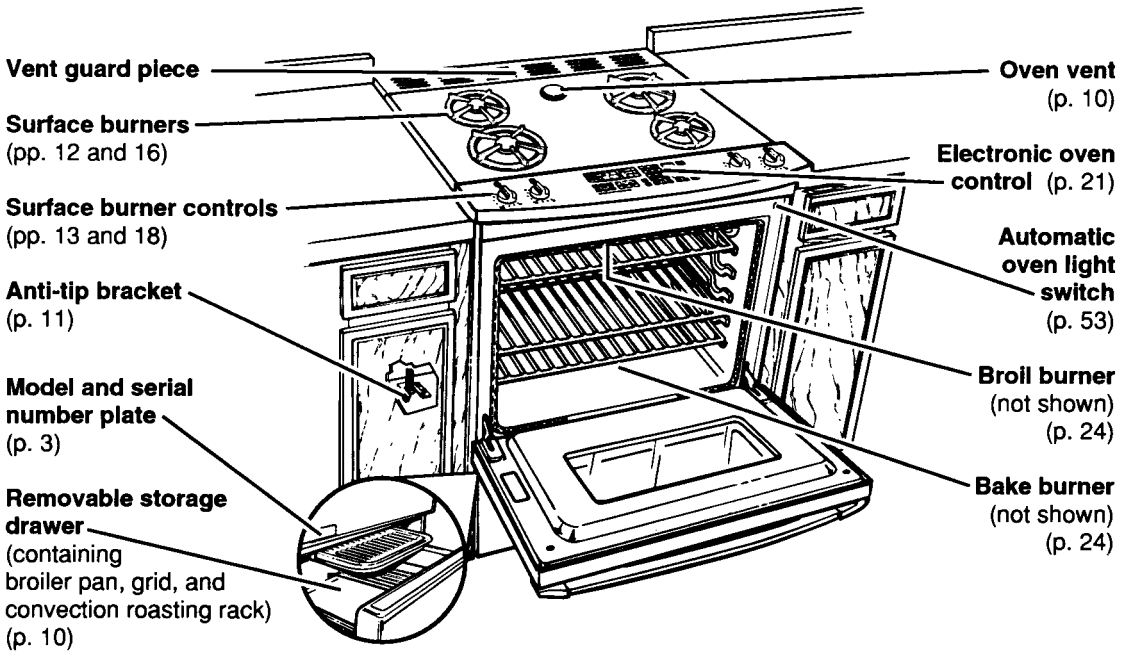

Surface burner controls

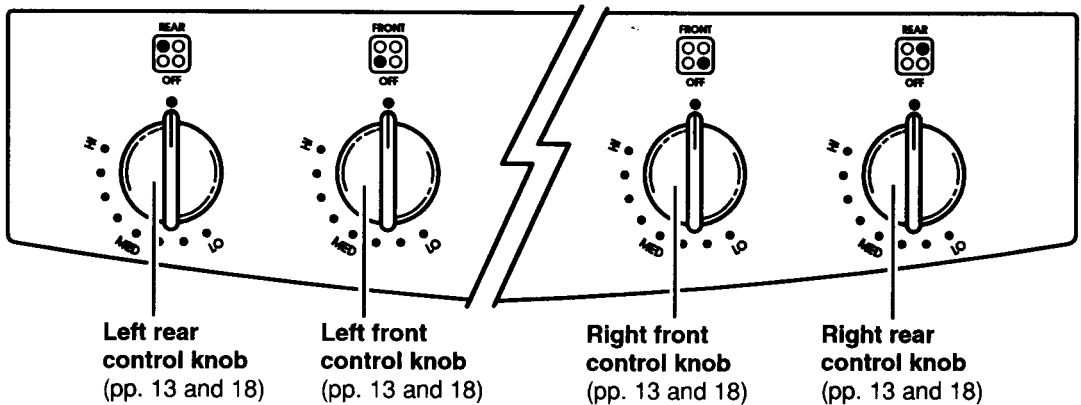

Getting to Know Your Range

Model KGRT507B

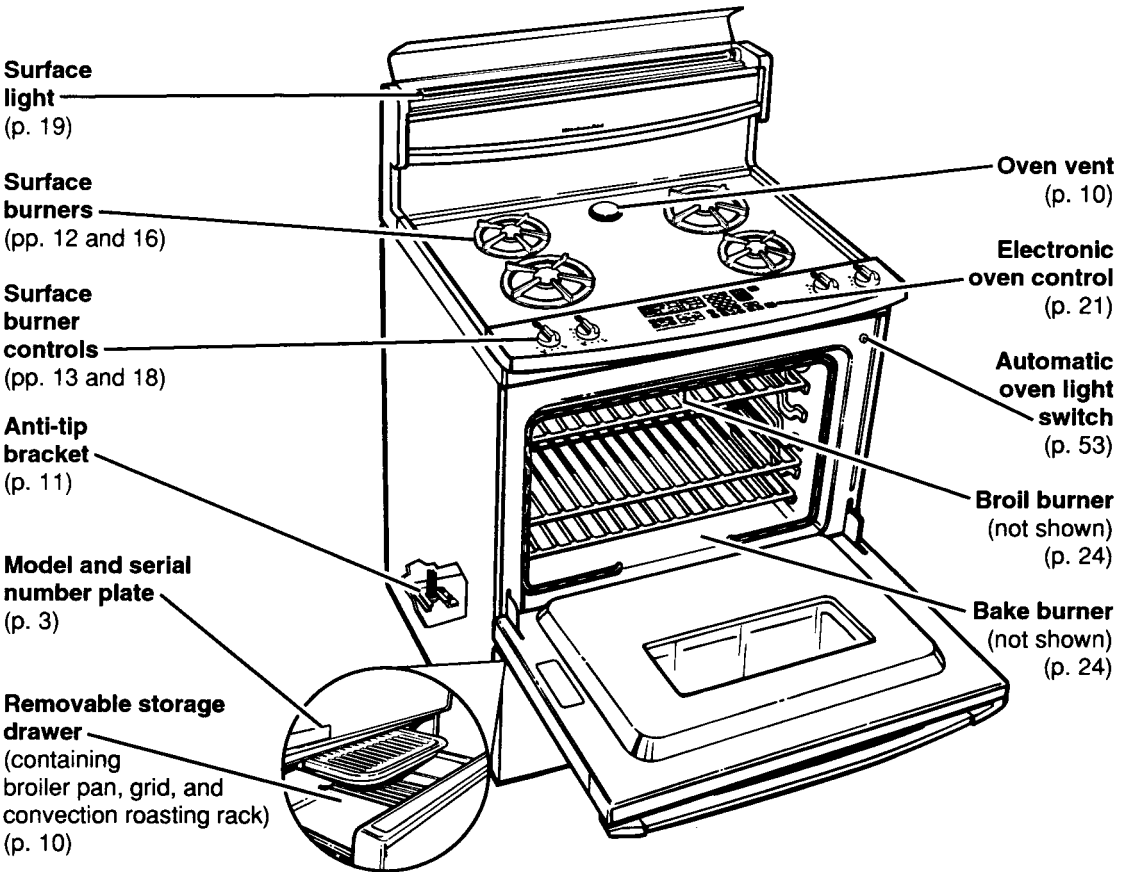

Surface burner controls

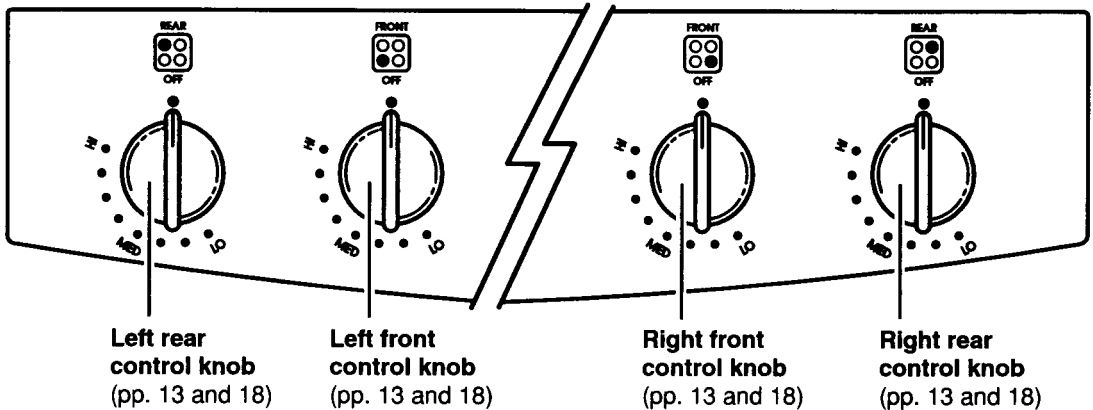

Getting to Know Your Range

The oven vent

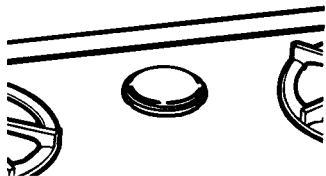

Hot air and moisture escape from the oven through a vent in the center rear of the cooktop. **Do not block the vent by using large pans or covers.** Poor baking/roasting and combustion can result.

⚠ WARNING



Burn Hazard

Use pot holders when touching items left near oven vent.

Failure to do so can result in burns.

The storage drawer

You can remove the storage drawer to make it easier to clean under the range and to check for installation of the anti-tip bracket. **Use care when handling the drawer.**

Removing the storage drawer:

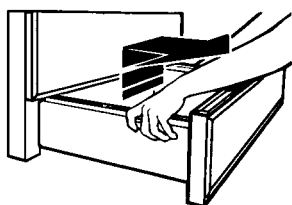

1. **Empty** drawer of any pots and pans before removing drawer. **Use** recessed area on top edge of drawer to pull drawer straight out to the first stop. **Lift** front and **pull out** to the second stop.
2. **Lift** back slightly and **slide** drawer all the way out.

Replacing the storage drawer:

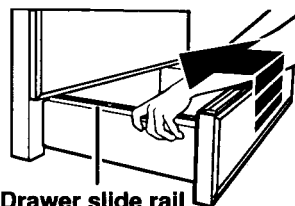

Drawer slide rail

1. **Fit** ends of drawer slide rails into the drawer guides on both sides of opening.
2. **Lift** drawer front and **press in** until metal stops on drawer slide rails clear white stops on drawer guides. **Lift** drawer front again to clear second stop and **slide** drawer closed.

Getting to Know Your Range

The anti-tip bracket

The range will not tip during normal use. However, tipping can occur if you apply too much force or weight to the open door without the anti-tip bracket properly secured.

	<p style="text-align: center;">⚠ WARNING</p> <p style="text-align: center;">Tip Over Hazard</p> <p>Connect anti-tip bracket to the range.</p> <p>Reconnect anti-tip bracket, if the range is moved.</p> <p>Do not push down on the open oven door.</p> <p>Follow the Installation Instructions.</p> <p>Do not let children climb onto the oven door.</p> <p>Failure to follow these instructions can result in death, burns, or other injury.</p>
--	---

To verify the anti-tip bracket is engaged:

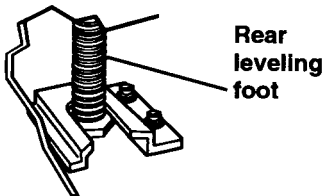

- **Remove** the storage drawer.
(See page 10.)
- **Look** to see if the anti-tip bracket is attached to floor with screws.
- **Make sure** left rear leveling foot is positioned under the anti-tip bracket.
- **See** Installation Instructions for further details.

Using and Caring for Your Cooktop

This section tells you how to operate the controls to the cooktop. It also discusses how the sealed gas burner cooktop works, and includes tips on how to cook with and maintain the cooktop.

Using the surface burners

Your cooktop has sealed gas burners with an auto-reignition system. The sealed burners spread the heat evenly across the bottom of the cookware and provide infinite heat control. The auto-reignition system senses when a burner flame has gone out and will automatically reignite that burner.

IMPORTANT: Your cooktop is factory-set for use with Natural Gas. If you wish to use L.P. gas, an L.P. Gas Conversion Kit (Part No. 9752401) is available from your KitchenAid dealer or authorized parts distributor. The conversion must be done by a qualified service technician.

When to use the right rear and left front burners:

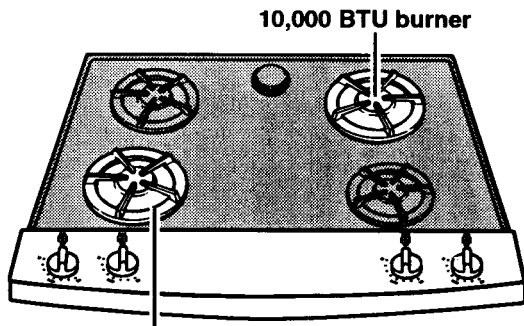

10,000 BTU burner

Use these burners for cooking large quantities of food, deep-fat frying, or cooking with large cookware.

When to use the left rear and right front burners:

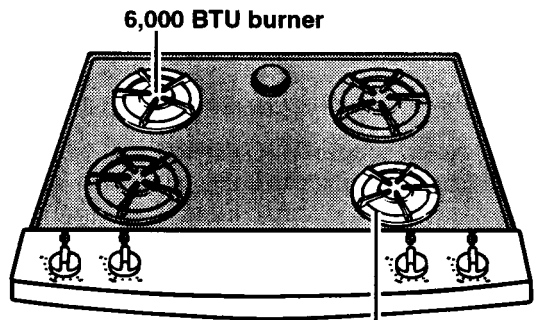

6,000 BTU burner

Use these burners for simmering or for cooking smaller quantities of food requiring small cookware.

Using and Caring for Your Cooktop

⚠ WARNING

Carbon Monoxide Poisoning Hazard
Do not operate with a yellow flame.
Doing so can result in death, heart attack, or convulsions.

How to use the surface burners:

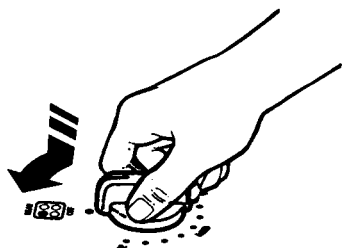

1. **Grasp** the control knob.
2. **Push down** and **turn** to HI. The electric spark ignitor will ignite the gas flowing into the burner. When you hear a clicking sound, you know that the ignitors are working. Gas is flowing as long as knob is not set at OFF.
3. **When the burner is lit, turn** the control knob to the desired flame setting. (See guide under "Burner heat settings" on page 14.) You can turn the knobs to any of the marked settings. The ignitor will turn off and the clicking will stop when the burner ignites.

NOTES:

- **The ignitors** may click a number of times before burner lights. This is normal.
- **All four burner ignitors** will spark regardless of which burner you are using.
- **Visually check** that the burner has lit. If the burner does not ignite, listen for the clicking sound. If you do not hear the ignitor click, **TURN THE BURNER OFF.** Check that the service cord is placed firmly in the wall receptacle. Check for a tripped circuit breaker or blown fuse.

Check that the control knob is pressed completely down on valve shaft. **If the spark ignitor still fails to operate, call your nearest authorized KitchenAid servicer.**

Proper grounding and polarity are necessary for correct operation of the electric ignition system. If the wall receptacle does not provide correct polarity, the ignitor will become grounded and click every once in a while, even after the burner has ignited. A qualified electrician should check the wall receptacle to see if it is wired with correct polarity.

⚠ WARNING



Fire Hazard

Turn off all controls when done cooking.

Failure to do so can result in death, fire, or burns.

Burner heat settings

Use correct burner heat settings (see page 14). If the heat setting is too high, it can:

- **Char** bacon and cause curling.
- **Make** eggs tough and crisp at the edges.
- **Toughen** liver, fish, and seafood.
- **Scorch** delicate sauces and custards.
- **Cause** a boilover.

continued on next page

Using and Caring for Your Cooktop

Until you get used to the settings, use the following as a guide. For best results, start cooking at the high setting; then turn the control knob down to continue cooking.

SETTING	RECOMMENDED USE
HI	<ul style="list-style-type: none">• To start foods cooking.• To bring liquids to a boil.
MED	<ul style="list-style-type: none">• To hold a rapid boil.• To fry chicken or pancakes.• For gravy, pudding, and icing.• To cook large amounts of vegetables.
LO	<ul style="list-style-type: none">• To keep food warm until ready to serve.

In case of a prolonged power failure

Surface burners can be manually lighted.

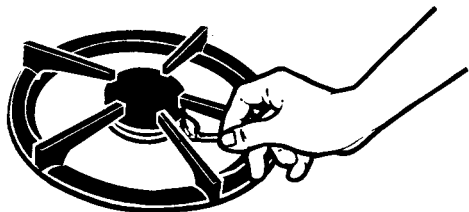

1. Hold a lit match near a burner and turn the control knob to the HI position.



2. After the burner lights, turn the control knob to the desired setting.

⚠ WARNING



Explosion Hazard

Turn the burners off if a flame goes out while cooking, or if there is a strong gas odor. Wait five minutes for the gas odor to disappear before relighting burner.

Do not let the burner flame extend beyond the edge of the pan.

Turn off all controls when not cooking.

Failure to follow these instructions can result in death, explosion, fire, or burns.

NOTE: Do not leave the cooktop unattended when cooking during a power failure. The auto-reignition feature of your cooktop will not operate during a power failure.

Using and Caring for Your Cooktop

Energy saving tips

Although the energy used for cooking is usually a very small percentage of the total energy used in the home, cooking energy can be used efficiently. Here are some tips to help you save energy when using your cooking product:

- **Use** pans with flat bottoms, straight sides, and tight-fitting lids.

- **Cook** with a minimum of liquid or fat to help shorten cooking time.
- **Start** food on higher heat settings, then set surface burner control on low to finish cooking.
- **Turn on** the surface burner only after placing filled pan on the burner.

Cookware tips

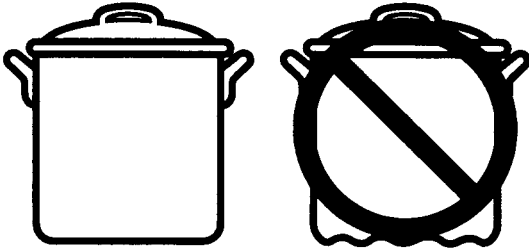

- **NOTE: For best results and greater fuel efficiency**, use only flat-bottomed cookware in good condition.

- **The pan** should have straight sides and a tight-fitting lid.
- **Be sure pans** do not tip, whether they are full or empty.
- **Pans** should be easy to clean. Check to be sure there are no crevices, rough edges, or areas where food might collect.
- **Use cookware** only as instructed in the cookware's user instructions. This is very important for glass cookware because some can be used only in the oven. Pans marked as flameware can be used on surface burners.
- **Choose medium to heavy gauge** (thickness) pans that are fairly lightweight.
- **The pan material** (metal or glass) affects how fast heat transfers from the surface burner through the pan material and how evenly heat spreads over the pan bottom. Choose pans that provide the best cooking results.
- **Handles** should be made of sturdy, heat-resistant material and be securely attached to the pan.

NOTE: Do not leave empty cookware, or cookware which has boiled dry, on a hot surface burner. The cookware could over-heat and damage the cookware or surface burner.

Home canning information

The large diameter of most water-bath or pressure canners combined with high heat settings for long periods of time can cause damage to the cooktop.

To protect your cooktop:

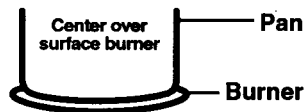

- **Use a canner/pan which can be centered over the surface burner.** Large diameter canners/pans, if not properly centered, trap heat and can cause damage to the cooktop.
- **Do not place canner** on two surface burners at the same time. Too much heat will build up and will damage the cooktop.
- **Start with hot water.** This reduces the time the control is set on high. Reduce heat setting to lowest position needed to keep water boiling.
- **Refer** to your canner manual for specific instructions.

Using and Caring for Your Cooktop

Caring for your cooktop

Your cooktop is designed for ease of care. You can do most cleaning with items found around the home. Cleaning your cooktop whenever spills or soiling occur will help to keep it looking and operating like new.

NOTES:

- **Before cleaning** make sure all controls are off and the cooktop is cool.
- **Do not obstruct** the flow of combustion and ventilation air.
- **If knobs are removed** while cleaning, be careful not to spill liquids through holes in the control area.
- **Be careful** not to allow moisture to collect in control area. Moisture could cause ignitor switches to fail.

Surface burners

- **The burner caps** should be routinely removed and cleaned. Always clean burner caps after a spillover. Keeping the burner caps clean prevents improper ignition and an uneven flame.
- **For proper flow** of gas and ignition of the burner, **DO NOT ALLOW SPILLS, FOOD, CLEANING AGENTS, OR ANY OTHER MATERIAL TO ENTER THE GAS TUBE OPENING.**
- **Occasionally check** the burner flames for proper size and shape. A good flame is blue in color. If flames lift off ports, are yellow, or are noisy when turned off, you may need to clean the burners.

NOTE: To check oven burner flames for proper size and shape, see the Installation Instructions.

To clean burners and burner caps:

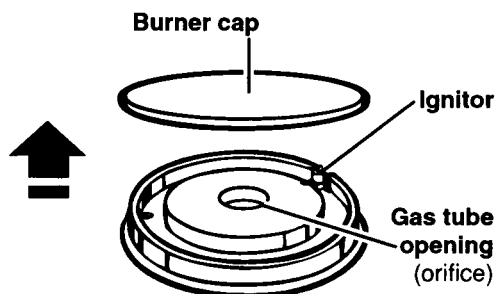

1. **Lift** the burner cap straight up from the burner base.
2. **Clean** burner cap with warm, soapy water and a sponge. For stubborn stains, clean with a mildly abrasive plastic scrubbing pad and powdered cleanser. Do not clean burner cap in dishwasher.
3. **If the gas tube opening** or the orifice, located inside the opening, has become soiled or clogged, **use** a cotton swab or a soft cloth to clean the area.
4. **If ports are clogged**, clean with a straight pin. **Do not enlarge or distort port. Do not leave anything stuck in the ports.**
5. **After cleaning** the gas tube opening and ports, **replace** the burner cap. **To replace burner cap, make sure** cap is properly aligned and leveled.
6. **Check** the burner after cleaning for proper lighting.

Using and Caring for Your Cooktop

Adjusting the height of top burner flames

⚠ WARNING

Carbon Monoxide Poisoning Hazard

Do not operate with a yellow flame.

Doing so can result in death, heart attack, or convulsions.

The LO burner flame should be a steady blue flame approximately $\frac{1}{4}$ inch high. It can be adjusted using the adjustment screw in the center of the valve stem. The valve stem is located directly underneath the control knob.

To adjust the flame height follow the instructions below:

- 1. Remove** the control knob. (If there is not an adjustment screw underneath the knob the flame height is not adjustable.)
- 2. Hold** the valve stem with a pair of pliers. The screw is located in the center of the valve stem. Use a small flat head screwdriver to turn the screw until the flame is the proper size.
- 3. Replace** the control knob.
- 4. Test** the flame by turning the control from "LO" to "HI," checking the flame at each setting.

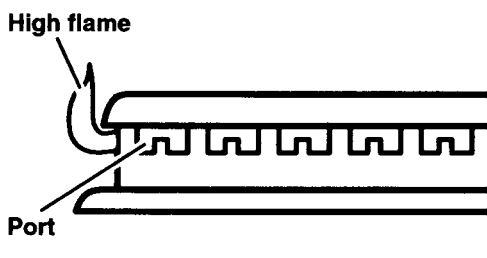
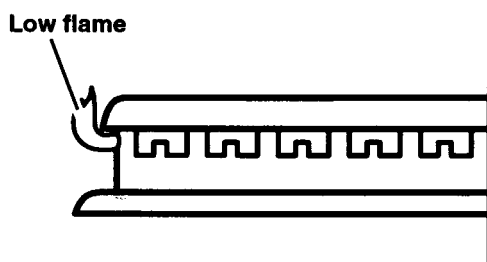
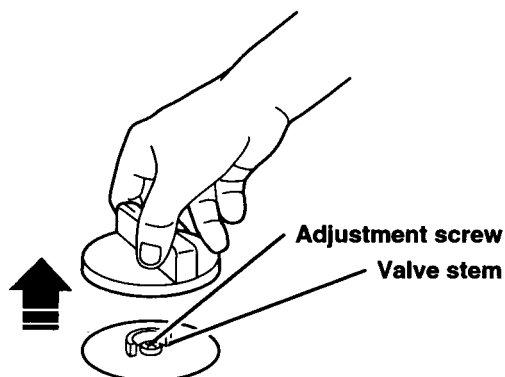

Using and Caring for Your Cooktop



! WARNING

Explosion Hazard

Do not store flammable materials such as gasoline near this appliance.

Doing so can result in death, explosion, fire, or burns.

Cleaning your cooktop

PART	WHAT TO USE	HOW TO CLEAN
Control knobs	Sponge and warm, soapy water	<ul style="list-style-type: none"> • Turn knobs to OFF and pull straight away from control panel. • Wash, rinse, and dry thoroughly. Do not soak. • Do not use steel wool or abrasive cleansers. They may damage the finish of the knobs. • Replace knobs. Make sure all knobs point to OFF.
Tempered glass surface	Sponge and warm, soapy water OR Paper towel and spray glass cleaner	<ul style="list-style-type: none"> • Remove grates. • Wash, wipe with clean water, and dry thoroughly. • Use nonabrasive, plastic scrubbing pad on heavily soiled areas. • Do not use steel wool, abrasives, or harsh cleansers. They may damage the finish. • If you use soap or detergent solutions, wipe thoroughly to prevent filmy residue. <p>NOTE: When cleaning cooktop with knobs removed, do not allow water to run down inside unit.</p> <ul style="list-style-type: none"> • Replace grates.
Surface burner grates	Warm, soapy water and a mildly abrasive plastic scrubbing pad and/or powdered cleanser	<ul style="list-style-type: none"> • Remove grates. • Wash the grates with a mildly abrasive plastic scrubbing pad and warm, soapy water. Rinse and dry well. For stubborn stains, clean with a scrubbing pad and/or a powdered cleanser and water. Repeat these cleaning steps as needed. • For best cleaning and to avoid possible rusting of unfinished surfaces, do not clean in a dishwasher or self-cleaning oven. • Replace grates.
Surface burners and caps		See page 16 and above for cleaning instructions.

Using and Caring for Your Cooktop

Using and replacing the surface light

(Model KGRT507B)

The surface light is in the backguard. It is controlled by the Surface Light Command Pads on the control panel. The On Command Pad turns on the light immediately and keeps it on until you press OFF. The Night Command Pad will turn on the surface light automatically when the light in the room is low enough to require a night light. When the night light comes on, it will also dim all lights appearing on the display. Press OFF to turn off the regular surface light or press NIGHT again to turn off the night light.

To turn on the surface light:

PRESS



To turn off surface light:

PRESS



To turn on night light:

PRESS



"NIGHT LIGHT" shows on the display when the night light is on.

To turn off night light:

PRESS again



Replacing the surface light:

1. **Unplug** appliance or **disconnect** at main power supply.

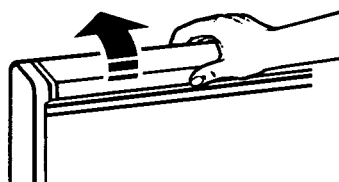

2. **Flip up** the top of the backguard.

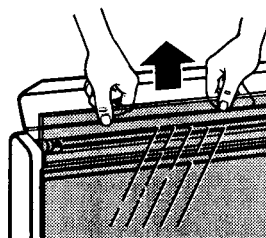

3. **Pull up** glass on front of backguard.

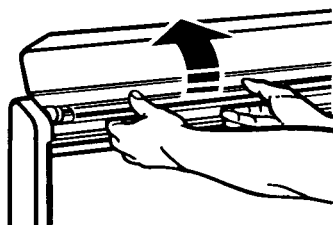

4. **Grasp** the fluorescent light tube at both ends. **Turn** the tube approximately 90° in either direction until both ends come out of the receptacles. **Replace** with a 20-watt cool-white fluorescent light tube.

continued on next page

Using and Caring for Your Cooktop

5. If the surface light still does not work, you may need to replace the starter. The starter is a knob-shaped part located on the right side of the backguard, under the light tube.

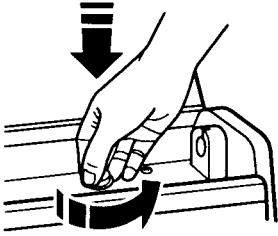

- To remove and replace the starter, first remove light tube. Push starter in and turn approximately 90° counterclockwise. Pull starter out of recessed area. You can find replacement starters at stores that sell fluorescent light tubes.
6. Replace glass and close the top panel. Plug in appliance or reconnect at main power supply.

Using and Caring for Your Oven

This section tells you, step by step, how to operate all oven functions controlled by the electronic control. Carefully follow these instructions, along with the cooking tips and cleaning information, for successful use of your range. Your model may not have all the features shown on the control display.

Using the electronic oven control

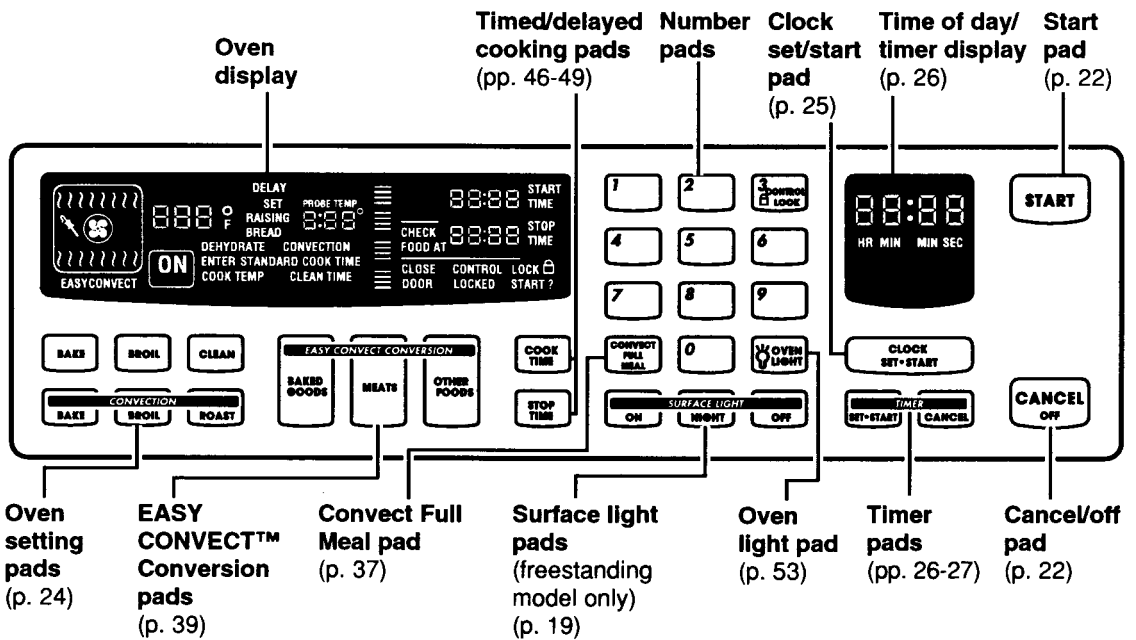

Display/clock

- **When you first plug in the range,** a tone will sound, the display will be fully lit for a few seconds, and the display will show the last time set and “PF” (power failure). If, after you set the clock (page 25), the display again shows “PF”, your electricity was off for a while. Reset the clock.
- **The time display will show “Err”** and 3 short tones will sound if a time or temperature is incorrectly entered.

NOTE: If you press a command pad several times, the pad can stop working. If you wait a few seconds, you can use the pad again. When you first use the pad again, you may have to hold down on the pad a short time to get it to work.

Using and Caring for Your Oven

Fahrenheit/celsius

- **You can set your oven to cook in Celsius instead of Fahrenheit** by opening the oven door, then pressing BROIL for 5 seconds. (You will know you are in Celsius when “F” disappears.) To switch back to Fahrenheit, press BROIL again for 5 seconds. (“F” will reappear.)

If you need to convert temperatures from Celsius to Fahrenheit or vice versa, you can refer to this chart:

Temperature replacement values

38°C-100°F	177°C-350°F
60°C-140°F	191°C-375°F
66°C-150°F	204°C-400°F
77°C-170°F	218°C-425°F
93°C-200°F	232°C-450°F
121°C-250°F	246°C-475°F
135°C-275°F	260°C-500°F
149°C-300°F	
163°C-325°F	

Starting an operation

After programming a function, you must press the Start pad to start the function. If you do not press the Start pad within 5 seconds of programming, “START?” will show on the display as a reminder.



Canceling an operation

The Cancel/Off pad will cancel any function, except for the Clock Set/Start and Timer functions. When you press the Cancel/Off pad, the large display will show the time of day or, if Timer is also being used, the time remaining.



Changing audible signals

Audible signals tell you if a function is entered correctly or not. They also tell you when a cycle is completed.

To shut off end-of-cycle tone:

Open the door

Then

PRESS and hold for 5 seconds



To change pitch and loudness of key tone:

Open the door

Then

PRESS and hold for 5 seconds

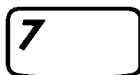

To shut off reminder tones:

Open the door

Then

PRESS and hold for 5 seconds



To shut off key entry tone:

Open the door

Then

PRESS and hold for 5 seconds



A short tone will sound to tell you the signals have been changed. Repeat step above to turn the signals back on.

Using and Caring for Your Oven

In case of a power failure

Your oven will not work during a power failure. Do not try to relight the oven. Wait for the power to come back on before using the oven again.

Using the control lock

The control lock prevents unwanted use of the oven by disabling the control panel command pads.

NOTES:

- **Control lock** is only available when oven is not in use or control has not been set.
- **Control lock** will not disable the Timer.
- **Set control lock** when cleaning the control panel to prevent oven from accidentally turning on.

To lock or deactivate the control panel:

Open the door, then press and hold the Control Lock pad (Number Pad 3) for 5 seconds. A single tone will sound and "CONTROL LOCK 

To unlock the control panel:

Open the door, then press and hold the Control Lock pad (Number Pad 3) for 5 seconds. A single tone will sound after 5 seconds and "CONTROL LOCK 

Setting your range for the Sabbath*

If you want to set your range to meet "no work" requirements for the Sabbath, follow these steps:

1. **Turn** the oven light and/or surface light (if available) on or off (see pages 19 and 53). These lights will stay turned on or off (whichever you set) while in the Sabbath mode. Opening the door will not turn on the oven light if it is programmed to be off.

* Star K certification pending. Full certification by Star K is expected in early 1997. Information is accurate as of 9/96.

2. **If a power failure occurs**, the oven will automatically run the Favorite Cycle set in Convection Full Meal when power is back on. **To prevent the oven from running a cook time and turning off at the end of that time, set CONVECT FULL MEAL** with the bake cycle you want to use during the Sabbath. (Be sure to set a cook time of "0".) To set a favorite cycle:

A. Press CONVECT FULL MEAL.

B. Press BAKE.

C. Press Number Pads to enter the temperature.

D. Press COOK TIME, followed by Number Pad 0.

E. Press CONVECT FULL MEAL to save the cycle.

F. Press CONVECT FULL MEAL again to confirm that setting is programmed.

G. Press CANCEL/OFF.

NOTE: After a long power failure, you may see the oven temperature increase on the display. This will happen only when the oven has cooled enough to require preheating. The temperature display will stop changing once the Favorite Cycle's set temperature is reached.

3. **Press** BAKE.
4. **Press** Number Pads to set the temperature you want.
5. **Press** START. **Wait** for the oven to preheat. (A tone will sound when oven is preheated.)
6. **Open the door**, then press and hold Number Pad 6 for 5 seconds to go into the Sabbath mode.

NOTE: Use the Sabbath mode with the Bake function only.

Using and Caring for Your Oven

What your oven will do while in the Sabbath mode:

- **The time display** will show "SAbb" to tell you that the oven is in the Sabbath mode.
- **The ON Indicator Light** will light up when the heating element turns on and ON will go off when the heating element turns off.
- **To prevent accidental key presses**, the key pads will only work after you press them for 1 second.
- **No tones** will sound.

To end the Sabbath mode:

- **Open the door**, then press CANCEL/OFF for 1 second. Next, **press and hold** Number Pad 6 for 5 seconds. (Or you can **press and hold** Number Pad 6 for 5 seconds first, followed by CANCEL/OFF.)

Oven settings

This chart tells you when to use each setting. It also explains what burners heat up for each setting.

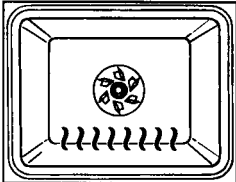
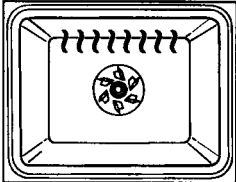
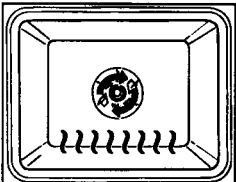
SETTING	DIAGRAM	SETTING INFORMATION
<p>BAKE Use this setting for baking and heating casseroles.</p>		<ul style="list-style-type: none"> • The bake burner lights up. • During baking, the burner will turn on and off to maintain the oven temperature.
<p>BROIL Use this setting for broiling regular-sized and smaller cuts of meat, poultry, and fish.</p>		<ul style="list-style-type: none"> • The broil burner lights up. • During broiling, the burner will turn on and off to maintain the oven temperature.
<p>CONVECTION BAKE Use this setting for foods which require gentle heating and for baking breads and cakes. Use also when baking large quantities of food on more than one oven rack.</p>		<ul style="list-style-type: none"> • The bake burner lights up. • One minute after the setting starts, the fan at the back of the oven will go on. • The fan circulates air in the oven cavity for even heating.

Using and Caring for Your Oven

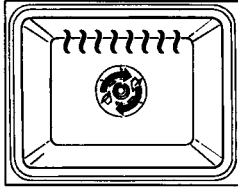
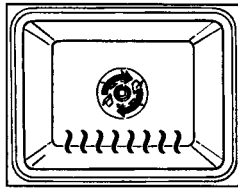
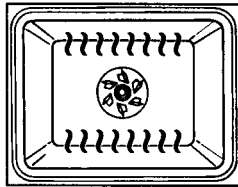
SETTING	DIAGRAM	SETTING INFORMATION
<p>CONVECTION BROIL Use this setting for broiling thick cuts of meat.</p>		<ul style="list-style-type: none"> • The broil burner lights up. • During broiling, the burner will turn on and off to maintain the oven temperature. • One minute after the setting starts, the fan at the back of the oven will go on. • The fan will cycle on for 10 seconds and off for 20 seconds.
<p>CONVECTION ROAST Use this setting for roasting and baking on one rack.</p>		<ul style="list-style-type: none"> • The bake burner lights up. • One minute after the setting starts, the fan at the back of the oven will go on. • The fan circulates air in the oven cavity for even heating.
<p>CLEAN Use this setting for self-cleaning only.</p>		<ul style="list-style-type: none"> • The broil burner cycles for the first 30 minutes. • After 30 minutes, the bake burner cycles at the clean temperature.

Setting the clock

NOTE: If an oven function is active or programmed, you cannot change the clock.

1. Press Clock Set/Start pad.

PRESS



YOU SEE



2. Set time.

PRESS

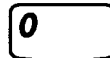

YOU SEE



continued on next page

Using and Caring for Your Oven

3. Start clock.

If time has not been entered correctly, three short tones will sound and “Err” will be displayed. The display will show the closest valid time. Repeat Steps 2 and 3 to re-enter the time of day.

NOTE: You can clear the time of day from the display by opening the door then pressing and holding CLOCK SET/START for 5 seconds. Repeat to see time of day on display again.

PRESS



YOU SEE



Using the timer

The Timer does not start or stop the oven. It works like a regular kitchen timer. It can be set in hours and minutes up to 99 hours, 59 minutes or in minutes and seconds up to 99 minutes, 59 seconds.

1. Press Timer Set/Start pad.

- **Once** to set hours and minutes
- **Twice** to set minutes and seconds

PRESS



YOU SEE



(example shows hours and minutes timer setting 1)

2. Set time.

PRESS

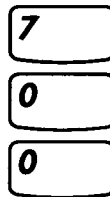

YOU SEE



(example shows a 7-hour timer setting)

3. Start Timer.

The Timer will begin counting down immediately after you press the Timer Set/Start pad or Start pad.

PRESS



YOU SEE



Using and Caring for Your Oven

4. When time is up, turn off Timer.

When time is up, you will hear four tones (if tones are not turned off – see page 22). Press the Timer Cancel pad to clear the display.

YOU SEE



To change the timer during its operation:

1. **Press** Timer Set/Start pad.
2. **Enter** new desired time.
3. **Press** Timer Set/Start pad.

To cancel the timer during its operation:

You can cancel the Timer any time during its operation. Press the Timer Cancel pad.

PRESS



Baking or convection baking

NOTE: Do not attempt to light the oven burner during a power failure. See "Range Safety" on page 5 for more information.

1. Position racks.

For correct rack placement, see "Rack positions" on page 31 and "Rack placement" chart on page 31.

NOTES:

- **Before turning oven on** position oven rack(s) in desired location.
- **Be sure** the rack(s) is level.
- **Use pot holders or oven mitts to protect hands** if rack(s) must be moved while oven is hot.
- **Do not let** pot holder or oven mitt touch oven bottom.

NOTE: See "Cooking tips" on page 30 for additional cooking tips.

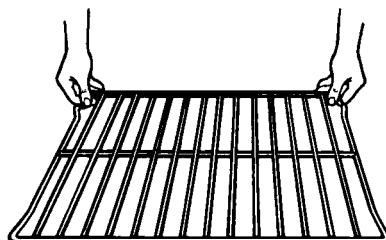

continued on next page

Using and Caring for Your Oven

2. Choose baking setting.

PRESS



OR

PRESS



YOU SEE



YOU SEE



3. Set temperature (optional).

Do this step if you want to set a temperature other than 350°F for Bake or 300°F for Convection Bake.

NOTE: See a reliable cookbook or your convection oven cookbook for temperature recommendations.

PRESS

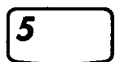
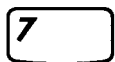

YOU SEE



(example for Bake at 375°F)

4. Preheat oven.

After the temperature reaches 170°F, the temperature display will show the actual oven temperature at each 5°F increase and stop at the set temperature. One long tone will sound when oven is preheated.

NOTE: For convection cooking, the fan will be delayed for 1 minute to provide good ignition. The fan may cycle on and off during convection cooking.

PRESS



YOU SEE

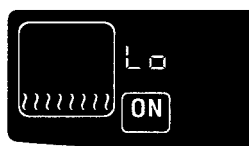

(example for Bake) ("Lo" is displayed after 5 seconds if oven temperature is below 170°F)

5. Put food in oven.

NOTE: If you want to change the baking temperature after baking has begun, repeat Steps 2, 3, and 4.

6. After cooking, turn off oven.

PRESS



YOU SEE

(display will go blank)

Using and Caring for Your Oven

Roasting

NOTE: Do not attempt to light the oven burner during a power failure. See “Range Safety” on page 5 for more information.

1. Prepare oven.

Position the rack properly. For correct rack placement, see “Rack positions” on page 31. Place food in the oven. For large roasts and turkeys, place rack in position 1 or 2.

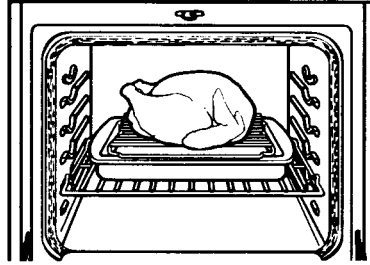

2. Choose setting.

PRESS



YOU SEE

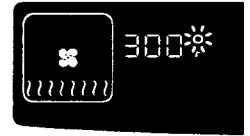

3. Set temperature (optional).

Do this step if you want to set a temperature other than 300°F.

NOTE: See your convection oven cookbook for temperature recommendations.

PRESS

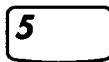
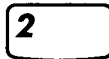

YOU SEE

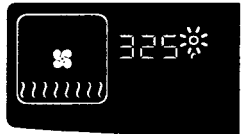

(example shows 325°F temperature setting)

continued on next page

Using and Caring for Your Oven

4. Start oven.

NOTES:

- After the temperature reaches 170°F, the temperature display will show the actual oven temperature at each 5°F increase and stop at the set temperature. One long tone will sound when oven is preheated.
- If you want to change the roasting temperature after roasting has begun, repeat Steps 2, 3, and 4.
- The fan will be delayed for 1 minute to provide good ignition.
- The fan may cycle on and off during convection roasting.

PRESS



YOU SEE



("Lo" is displayed after 5 seconds if oven temperature is below 170°F)

5. After cooking, turn off oven.

PRESS



YOU SEE

(display will go blank)

Cooking tips

Baking/convection baking tips

The hot air must circulate around the pans in the oven for even heat to reach all parts of the oven. This results in better baking.

For best air circulation:

- Place the pans so that one is not directly over the other.



- For best results, allow 1 1/2 to 2 inches of space around each pan and between pans and oven walls.
- When baking with one pan, place pan in the center of the oven rack.

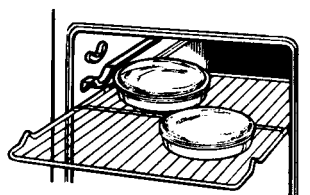

- When baking with two pans, place pans in opposite corners of the oven rack.

NOTES:

- "Oven peeking" may cause heat loss, longer cooking times, and unsatisfactory baking or roasting results. Rely on your timer.
- Do not allow pans to touch the heat sensor on the left wall near the back. Poor baking may result.
- Do not use aluminum foil when baking. Aluminum foil may block airflow.

Using and Caring for Your Oven

Rack positions

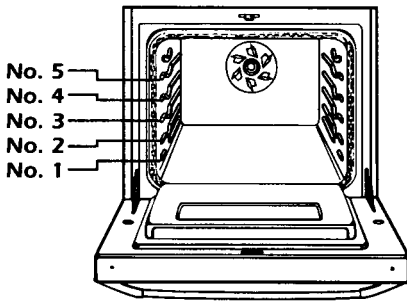

Your oven has three straight racks and five rack positions. Rack position 5 is the highest position, or farthest from the bottom of the oven. Rack position 1 is the lowest position, or closest to the bottom of the oven.

Baking tips

(Bake pad)

For proper cooking, follow these guidelines:

- **When using one rack**, place the rack so the top of the food will be centered in the oven.
- **When using more than one rack**, use the Convection Bake setting.
- **Use only one** cookie sheet in the oven at a time when using the Bake setting.

Bakeware tips

- **When baking with insulated cookie sheets or baking pans**, place them in the bottom third of the oven. You may need to increase the recommended baking times, so test for doneness before removing from the oven.
- **When using ovenproof glassware or dark bakeware**, reduce the oven temperature by 25°F, but use the same baking time. Because these pans absorb heat, producing darker bottom browning and crispier crusts, place the rack in the center of the oven. When baking pies and bread, you can use the temperature suggested in the recipe.

Rack placement for specific foods:
(For rack positions, see "Rack positions" in previous column.)

FOOD	RACK POSITION
Frozen pies	2
Angel food and bundt cakes, most quick breads, yeast breads, casseroles, meats	1 or 2
Cookies, biscuits, muffins, cakes, nonfrozen pies	2 or 3

NOTE: For additional baking tips see "Baking or convection baking" on page 27.

Convection baking tips

(Convection Bake pad)

- **Do not use** aluminum foil when convection baking. Aluminum foil may block airflow.
- **Reduce** recommended standard cooking temperatures by approximately 25°F. The cooking times can also be reduced for most recipes. See recipe adaption chart in your convection oven cookbook for recommended temperatures and times, or use EASY CONVECT™ Conversion (see page 39).
NOTE: Cooking time may be longer when you use more than one rack.
- **When baking on two or three racks**, use the Convection Bake setting for more even results. (You can, however, use only one rack when Convection Baking.)

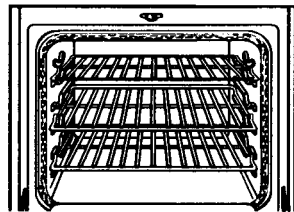

- **To use three racks during convection baking**, place one rack in position 5 (the highest position), another rack in position 1 (the closest to the oven bottom), and the third rack in position 3. This allows all three racks to be an equal distance apart for better baking.
- **Stagger** cake pans or other cookware in opposite directions on each rack when three racks are used.

Using and Caring for Your Oven

Roasting tips

- **Spatter can be reduced** by lining the bottom of the roasting pan with lightly crushed aluminum foil.
- **Use an accurate meat thermometer or temperature probe** (see page 34) to determine when meat has reached desired degree of doneness. Insert the thermometer or probe into the center of the thickest portion of the meat or inner thigh or breast of poultry. For an accurate reading, the tip of the thermometer or probe should not touch fat, bone, or gristle.
- **After reading the thermometer once**, push it further into the meat $\frac{1}{2}$ inch or more and read again. If the temperature drops, return the meat to the oven for more cooking.
- **Check pork and poultry** with a thermometer in 2-3 places to ensure adequate doneness.
- **Poultry and roasts will be easier to carve** if loosely covered with foil and allowed to stand 10-15 minutes after removal from the oven.
- **You can reduce** roasting times and temperatures for most standard recipes when using the Convection Roast setting. See recipe adaption chart or convection-roasting chart in your convection oven cookbook for recommended roasting times and temperatures, or use EASY CONVECT™ Conversion (see page 39).

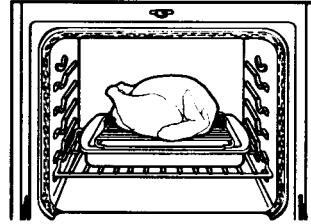

- **Use the convection roasting rack** on the broiler pan (both included with your range). (The convection roasting rack rests on the broiler pan, not inside it.) The long side of the rack should be parallel with the oven door for best heat distribution and airflow.

Using and Caring for Your Oven

Adjusting oven temperature

Although your new oven is properly adjusted to provide accurate temperatures, it may cook faster or slower than your old oven.

If, after using the oven for a period of time, you are not satisfied with the baking/roasting results, you can change the offset temperature by following the steps below. The control will “remember” the selected offset even after the power has been interrupted or lost.

NOTE: DO NOT measure oven temperature with a thermometer. Opening the oven door will lower the oven temperature and give you an inaccurate reading. Also, the thermometer temperature reading will change as your oven cycles.

1. Open the door, then press and hold Bake pad for 5 seconds.

Release the pad when a number appears on the temperature display and you hear a tone.

PRESS



Hold for
5 seconds

YOU SEE



(factory setting of “0”)

2. Set new offset temperature.

Each time you press the Bake pad, the displayed temperature will change by 5°F (3°C). You can set the offset temperature adjustment as low as -35°F (-21°C) or as high as +35°F (+21°C). (To determine the amount of adjustment needed, see the chart on page 34.)

NOTE: If there is no “F” after the temperature, you are in the Celsius mode.

PRESS



YOU SEE



(example when making oven 10°F hotter)

3. Enter the adjustment.

NOTE: If you press the Cancel/Off pad instead of the Start pad, the offset temperature will stay the same.

PRESS



YOU SEE

(display will go blank)

Using and Caring for Your Oven

How to determine the amount of adjustment needed

The following chart tells you how much to adjust the offset temperature to get the desired cooking results. You can determine cooking results by amount of browning, moistness, and rising times for baked foods.

TO COOK FOOD ...	ADJUST BY THIS NUMBER OF DEGREES (FAHRENHEIT)
A little more	+5 to +10
Moderately more	+15 to +20
Much more	+25 to +35
A little less	-5 to -10
Moderately less	-15 to -20
Much less	-25 to -35

Using the temperature probe

The Temperature Probe is the most accurate guide to the degree of doneness of meat. Use it when baking, roasting any type of meat or poultry, or cooking casseroles with liquid.

NOTES:

- **Do not use** the Temperature Probe when broiling, convection broiling, dehydrating, or raising bread.
- **Unplug** the Temperature Probe before self-cleaning the oven.

1. Insert probe into food.

Insert the probe into the center of the thickest portion of meat or into the inner thigh or breast of poultry, away from fat or bone.

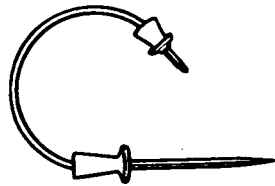

2. Put food in oven.

Place meat on the convection roasting rack, place rack on broiler pan, and place pan in the center of the oven.



3. Connect probe to oven.

Open the Temperature Probe cover located on the left side of the oven wall. Insert plug into jack. (Keep the top of the probe as far as possible from the heat source.)



YOU SEE



4. Close oven door.

Using and Caring for Your Oven

5. Set temperature (optional).

Do this step if you want to set an internal food temperature (from 130°F-190°F) other than 160°F.

NOTE: See a reliable cookbook or your convection oven cookbook for internal food temperature recommendations.

PRESS



YOU SEE



(example shows 150°F internal temperature setting)

6. Choose cook setting.

- BAKE,
- CONVECTION BAKE, or
- CONVECTION ROAST

PRESS



(example for Bake)

YOU SEE



7. Set temperature (optional).

Do this step if you want to set an oven temperature other than the one displayed.

NOTE: See a reliable cookbook or your convection oven cookbook for oven temperature recommendations.

PRESS



YOU SEE

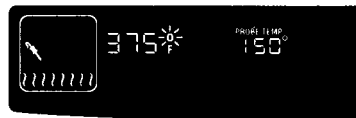

(example shows 375°F temperature setting)

8. Start oven.

NOTES:

- **If you do not choose** a cook setting and press START, the display will show a bake setting at 350°F. If you want to bake at 350°F, press START to begin. If you want to cook with another setting or at another temperature, do Steps 6 and 7 above and press START.
- **The temperature display** will show the set oven temperature throughout temperature probe cooking.
- **After the food temperature** reaches 130°F, the probe display will show the actual food temperature at each 5°F increase and stop at the set temperature. Four tones will sound and “End” will show when food reaches the set temperature (unless tones have been shut off – see page 22). The oven then shuts off.

PRESS



YOU SEE



(example for Bake)

continued on next page

Using and Caring for Your Oven

- **If you want to change** the probe temperature after cooking has begun, repeat Steps 6, 5, and 8, in that order. At Step 6, you will be prompted for a new probe temperature. You may also change the oven temperature at this point by pressing the Bake pad again.

⚠ WARNING



Burn Hazard

Use an oven mitt to remove temperature probe.

Do not touch broil element.

Failure to follow these instructions can result in burns.

9. After cooking, unplug probe.

The probe symbol will remain lit until you unplug the Temperature Probe.

10. Remove food from oven.

(This prevents overcooking.)

11. Clean probe.

Wash with a soapy sponge and dry thoroughly. Use a plastic scouring pad to remove cooked-on foods. You can also clean the probe in a dishwasher.

Using and Caring for Your Oven

Using CONVECT FULL MEAL

Convect Full Meal lets you choose from among 10 preset oven convection cooking cycles, all using the convection fan. These cycles store commonly used cooking times, cooking temperatures, and probe temperature settings. Convect Full Meal saves you time by limiting the number of pads you have to press when cooking a favorite food. Convect Full Meal also lets you set your own favorite cycle (either convection or nonconvection).

1. Place food in cold oven.

If you need the Temperature Probe for your cycle (cycles 5-8 in chart on page 38), insert probe into food. (Follow Steps 1-4 in "Using the temperature probe" on page 34.)

2. Press Convect Full Meal pad.

PRESS



YOU SEE



("C" stands for "cycle,"
"F" stands for "favorite")

3. Press desired Number pad.

Use the "Convect full meal chart" on page 38 as your guide for selecting a cycle.

NOTES:

- **You can change** the Convect Full Meal cycle any time before pressing the Start pad by repeating Step 3.
- **You can program your own cycle**, which you can then select in the future by pressing just CONVECT FULL MEAL and START. (See page 38 for more information.)

PRESS



YOU SEE



(example for cycle 1)



4. Start oven.

PRESS



YOU SEE



continued on next page

Using and Caring for Your Oven

5. When the Convect Full Meal cycle is done:

Four tones will sound, followed by four reminder tones every minute until you open the door, remove the probe, or press the Cancel/Off pad (if the reminder tone is not disabled).

YOU SEE

End

Convect full meal chart

CYCLE NUMBER	CONVECTION CYCLE	OVEN TEMP	TIME OR PROBE TEMP	FOOD OR MEAL
1	Conv. Bake	350°F	45 min	Meal # 1: Chicken pieces, Fruit crisp, Vegetable casserole
2	Conv. Bake	350°F	1 hr	Meal # 2: Macaroni and cheese, Baked winter squash, Fruit pie
3	Conv. Bake	350°F	1 hr 15 min	Meal # 3: Pre-cooked ham, Baked potatoes, Quick bread loaf OR Baked potatoes only
4	Conv. Bake	375°F	55 min	Meal # 4: Beef stew, Scalloped potatoes, Frozen fruit pie
5	Conv. Roast	300°F	140°F	Beef roast rare
6	Conv. Roast	300°F	160°F	Beef roast medium
7	Conv. Roast	300°F	170°F	Beef roast well Pork roast Meat loaf
8	Conv. Bake	325°F	160°F	Casseroles
9	Conv. Bake	325°F	3 hr	Pot roast with vegetables – 3 lbs
0	Conv. Roast	400°F	18 min	Pizza

To program your own cycle:

1. **Press** CONVECT FULL MEAL.
2. **Press** the Command Pad for the cook setting you want (for example, BAKE).
3. **Enter** the temperature and cook time you want. (The default is Bake at 170°F for 2 hours.) Entering a cook time of 0 minutes lets you do untimed cooking.
4. **To save only, press** CONVECT FULL MEAL.
To cook with this cycle immediately and save it, press START.

When programming your own cycle:

1. **Start** with meat or main dish items (times are more critical with these items).
2. **Choose** baked goods with bake temperatures similar to those of meat or main dish items. Convection baking time of +/-10 to 15 minutes and temperatures of +/-25 to 50 degrees are acceptable.
3. **Choose** vegetables and fruits last.

Using and Caring for Your Oven

Using EASY CONVECT™ Conversion

EASY CONVECT Conversion lets you convection cook without entering convection cook temperatures and times. Simply enter the standard cook temperature and time for the food to be cooked. The oven will reduce the temperature, or the temperature and time, for convection cooking. (Convection temperatures and times are not as long because the heated air is circulated in the oven cavity for quicker cooking.)

NOTE: The converted temperatures and times are not precise because the food categories you choose from are general. (See "EASY CONVECT Conversion setting chart" on page 41 for which foods you can cook in each category.) To ensure proper cooking, the oven will prompt you to check food at the end of cook time. If food needs more cooking, the oven will continue to cook. If food does not need more cooking, press CANCEL/OFF.

⚠ WARNING

Food Poisoning Hazard

Do not let food sit in oven more than one hour before or after cooking.

Doing so can result in death, food poisoning, or sickness.

1. Place food in oven.

2. Press one of three Easy Convection Conversion Pads.

Example for Meats:

PRESS



YOU SEE



3. Enter standard cook temperature.

PRESS

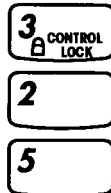

YOU SEE



(example showing 325°F – cooking without temperature probe)

continued on next page

Using and Caring for Your Oven

4. Enter standard cook time.

NOTES:

- **This step** is not needed when using the temperature probe.
- **To delay convection cooking**, after Step 4, press the Stop Time pad and enter the desired stop time. Cooking will start at the time equal to the stop time less the cook time. (Example: A cook time of 1 hour and a stop time of 4:00 would give you a start time of 3:00.)

PRESS

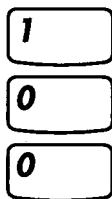

YOU SEE



(example showing 1 hour)

5. Start oven.

NOTE: The actual temperature reduction and time savings are different for each food category and oven type.

PRESS



YOU SEE



(display shows temperature reduced by 25°F – nondelayed cooking)

6. At end of cook time (nondelayed cooking):

YOU SEE



7. Open door and check food (nondelayed cooking).

If you want to continue cooking, close door and the oven will continue cooking.

If you do not want to continue cooking, press the Cancel/Off pad.

YOU SEE

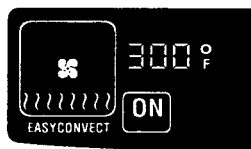

8. When stop time is reached (delayed cooking only):

Four tones will sound, followed by four reminder tones every minute, until you open the door, remove the probe, or press the Cancel/Off pad.

YOU SEE



Using and Caring for Your Oven

EASY CONVECT™ Conversion setting chart

EASY CONVECT SETTING	FOODS YOU CAN COOK WITH THIS SETTING
Baked Goods	Cakes, cookies, muffins, quick breads, biscuits, yeast bread
Meats	Roasts, ham, whole chicken, chicken pieces, chops, meat loaf NOTE: Turkey or large poultry are not included because their cooking times vary.
Other Foods	Egg and cheese dishes, fish, casseroles, frozen convenience foods, potatoes, squash, meat pies, fruit pies

Broiling

1. Position rack and close door.

See “Thermal broiling chart” on page 45 for recommended rack positions.

NOTES:

- **Before turning oven on** position oven rack(s) in desired location.
- **Be sure** the rack(s) is level.
- **Use pot holders or oven mitts to protect hands** if rack(s) must be moved while oven is hot.
- **Do not let** pot holder or oven mitt touch hot broil burner.

NOTE: See “Broiling tips” on page 44 for additional broiling tips.

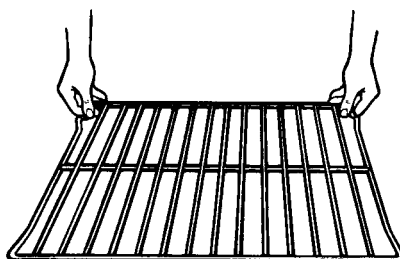

2. Preheat broiler for 5 minutes before using.

3. Press Broil pad.

PRESS



YOU SEE



continued on next page

Using and Caring for Your Oven

4. Set temperature (optional).

Do this step if you want to use variable temperature broiling (see below).

NOTE: See “Thermal broiling chart” on page 45 for temperature recommendations.

PRESS

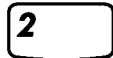

YOU SEE



(example shows 325°F broiling temperature)

5. Start oven.

NOTE: If you want to change the broiling temperature after broiling has begun, repeat Steps 3, 4, and 5.

PRESS



YOU SEE

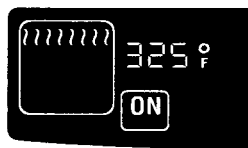

6. After preheating, put food in oven.

Place food on grid in broiler pan and place in center of the oven rack.

NOTES:

- **Place food** about 3 inches or more from the broil burner.
- **To ensure adequate grease drainage**, do not use cookie sheets or similar pans for broiling.
- **If foil is used** to cover broiler grid, cut slits in foil to allow grease to drain away.



Broiler grid



Broiler pan

7. Completely close door.

NOTE: Do not try to broil with the door open. The broil burner will not operate.

8. When broiling is done, turn off oven.

PRESS



YOU SEE

(display will go blank)

Variable temperature broiling

- **If food is cooking too fast** or you want the food to broil slower from the start, set the broil temperature between 170°F and 325°F. These temperature settings allow the broil burner to cycle and to slow cooking. The lower the temperature, the slower the cooking.
- **Fish and chicken** are some foods that may cook better if you use lower broiling temperatures.

Using and Caring for Your Oven

Convection broiling

Convection broiling is actually high-temperature convection roasting. Use this setting when broiling thick cuts of meat. Results are similar to those you get when using a rotisserie.

1. Position rack.

See “Thermal broiling chart” on page 45 for recommended rack positions.

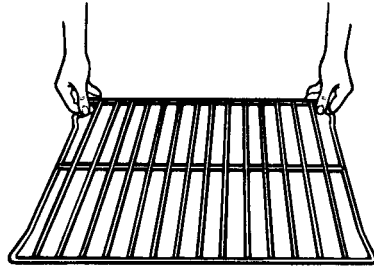

2. Preheat broiler for 5 minutes before using.

3. Press Convection Broil pad.

PRESS



YOU SEE

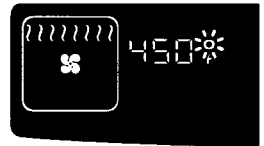

4. Set temperature (optional).

Do this step if you want to set a temperature (up to 500°F) other than 450°F.

NOTE: See your convection oven cookbook for temperature recommendations.

PRESS

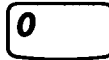
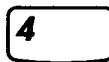

YOU SEE

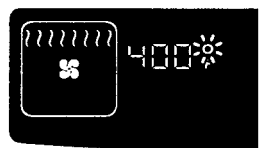

(example shows 400°F temperature setting)

5. Start oven.

NOTES:

- If you want to change the convection broiling temperature after broiling has begun, repeat Steps 3, 4, and 5.
- The fan will be delayed for 1 minute to provide good ignition.
- The fan will cycle on and off during convection broil.

PRESS



YOU SEE

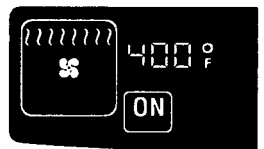

continued on next page

Using and Caring for Your Oven

6. After preheating, put food in oven.

Place food on grid in broiler pan and place in center of the oven rack. Turn the pan so the long side is parallel to the oven door for the most even heat and the best airflow.

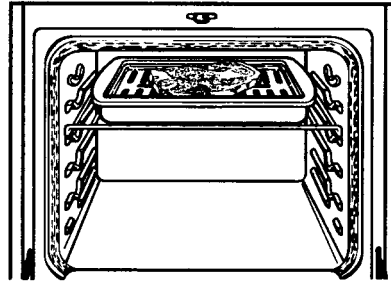

7. Close door.

NOTE: Do not try to convection broil with the door open. The fan and broil burner will not operate.

8. When broiling is over, turn off oven.

PRESS



YOU SEE

(display will go blank)

Broiling tips

- **Use** the broiler pan and grid for broiling. They are designed to drain excess liquid and grease away from the cooking surface to help prevent spatter, smoke, or fire.
 - **If you broil small quantities**, you may want to use a small broiler pan. They are available in the housewares section of many department stores.
 - **For best broiling results**, preheat for 5 minutes. Do not preheat with broiler pan in place.
 - **Broiling rack position** determines how the burner cooks your food. The lower the position, the more broiler grid area covered. See "Thermal broiling chart" on page 45 for more information.
 - **To sear meat**, place broiler pan at one of the higher rack positions so that meat is very near the flame.
 - **Thin (¾") steaks** may be broiled in the higher rack positions.
 - **To cook thick (1½") steaks** and other thick cuts of meat well done, start cooking on a lower rack position or move them to a lower rack position after searing.
 - **After broiling**, remove the broiler pan from the oven when you remove the food. Drippings will bake on the pan if you leave it in the heated oven.
- NOTE:** See "Broiling" on page 41 for additional broiling tips.

Using and Caring for Your Oven

Thermal broiling chart:

The recommended rack position is numbered lowest (1) to highest (5). Preheat broiler for 5 minutes before placing food in oven.

MEAT	RACK POSITION	TEMPERATURE	APPROXIMATE TIME (MINUTES)	
			SIDE 1	SIDE 2
Steak, 1" thick	4	500°F		
• rare			4	4
• medium			6	6
• well-done			8	8
Steak, 1½" thick	4	500°F		
• rare			8	8
• medium			10	10
Hamburger patties or steaks, ½" thick or less				
• medium	4	500°F	6	4
Lamb chops, 1" thick	4	400°F	9	9
Ham slice, ½" thick	4	500°F	5	5
precooked 1" thick	4	500°F	10	10
Pork chops, 1" thick	4	450°F	12	12
Frankfurters	4	500°F	4	4
Chicken pieces	3	500°F	16	16
Fish, 1" thick	3	350°F	10	10
Beef liver, ½" thick	4	350°F	5	5

Temperatures and times are guidelines only and may need to be adjusted to individual tastes.

Using and Caring for Your Oven

Timed cooking

The electronic clock/oven control will turn the oven on and off at times you set, even when you are not around.

Delayed time baking/roasting is ideal for foods which do not require a preheated oven, such as meats and casseroles. **Do not use delayed time cooking for cakes, cookies, etc. – they will not rise properly. Before using timed cooking, make sure the clock is set to the correct time of day.** (See “Setting the clock” on page 25.)

To start baking/roasting now and stop automatically:

1. Prepare oven.

Position the oven rack(s) properly and place the food in the oven. For correct rack placement, see “Rack positions” and “Rack placement” chart on page 31.

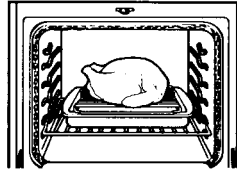

2. Choose cook setting.

- BAKE,
- CONVECTION BAKE, or
- CONVECTION ROAST

PRESS



YOU SEE

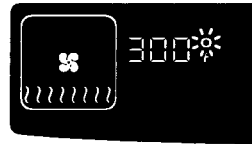

(example for Convection Roast)

3. Set temperature (optional).

Do this step if you want to set a temperature other than the one displayed.

NOTE: See a reliable cookbook or your convection oven cookbook for temperature recommendations.

PRESS

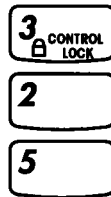

YOU SEE



(example shows 325°F temperature setting in Convection Roast)

Using and Caring for Your Oven

4. Press Cook Time pad.

PRESS



YOU SEE



(start time display will light up, showing time of day)

5. Set cook time.

PRESS

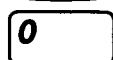
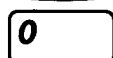
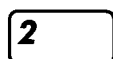

YOU SEE



(example shows 2-hour cook time with stop time now 2 hours later than time of day)

6. Start oven.

Vertical bar on display will get shorter as cook time counts down.

PRESS



YOU SEE

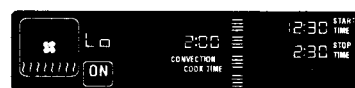

(cook time is displayed)

7. When baking/roasting is done:

"End" will show on the display. Four tones will sound, followed by four short reminder tones every minute until you open the door or press the Cancel/Off pad.

YOU SEE



To delay start and stop automatically:

1. Prepare oven.

Position the oven rack(s) properly and place the food in the oven. For correct rack placement, see "Rack positions" on page 31 and "Rack placement" chart on page 31.

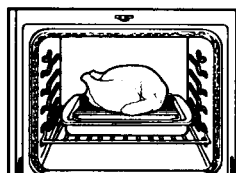

2. Choose cook setting.

- BAKE,
- CONVECTION BAKE, or
- CONVECTION ROAST

PRESS



YOU SEE

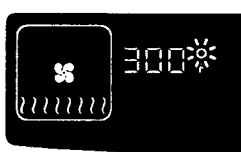

(example for Convection Roast)

continued on next page

Using and Caring for Your Oven

3. Set temperature (optional).

Do this step if you want to set a temperature other than the one displayed.

NOTE: See a reliable cookbook or your convection oven cookbook for temperature recommendations.

PRESS



YOU SEE

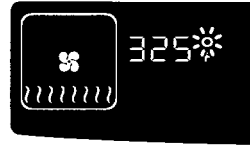

(example shows 325°F temperature setting in Convection Roast)

4. Press Cook Time pad.

PRESS



YOU SEE



(start time display will light up, showing time of day)

5. Set cook time.

PRESS

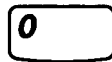

YOU SEE



(example shows 2-hour cook time with stop time now 2 hours later than time of day)

6. Press Stop Time pad.

PRESS



YOU SEE

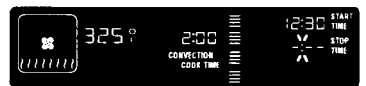

7. Set stop time.

PRESS

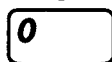

YOU SEE



(stop time display shows 3:00 and start time display shows 1:00 – stop time minus 2-hour cook time)

Using and Caring for Your Oven

8. Press Start pad.

When start time is reached:
Vertical bar on display will get shorter as
cook time counts down.

PRESS



YOU SEE



YOU SEE



9. When baking/roasting is done:

"End" will show on the display. Four
tones will sound, followed by four
short reminder tones every minute
until you open the door or press the
Cancel/Off pad.

YOU SEE



To cancel timed cooking settings:

Press Cancel/Off pad.

PRESS



YOU SEE

(display will go blank)

Dehydrating

You can use your THERMAL-CONVECTION™
oven to dehydrate a variety of foods.

NOTES:

- **If you do not turn off oven** after dehydrating, the oven will keep running until you press the Cancel/Off pad.
- **To learn detailed information** about dehydration, refer to a book written specifically about dehydrating and/or preserving foods.

1. Prepare food.

Prepare foods as recommended in
recipe.

2. Arrange food on drying racks.

Racks are not included with oven. See
page 50 to order a dehydration kit* which
includes racks and a spacer or contact a
local store handling specialty cookware.

continued on next page

Using and Caring for Your Oven

3. Place drying racks in the oven to allow maximum air circulation around the racks.

NUMBER OF RACKS	USE OVEN RACK POSITION
1 rack	3
2 racks	2 and 4
3 racks	1, 3, and 5

4. Position door.

Attach the dehydration spacer*, which is specially designed to depress the oven light plunger and maintain the operation of the fan during dehydration.

The spacer provides a 1 inch gap between the oven frame and the oven door allowing moisture to escape.

* The dehydration spacer (Part No. 814166) or the dehydration kit which includes racks and a spacer (Part No. 4395974) can be ordered from your local KitchenAid dealer, or by calling **1-800-422-1230** and following the instructions and telephone prompts you hear.

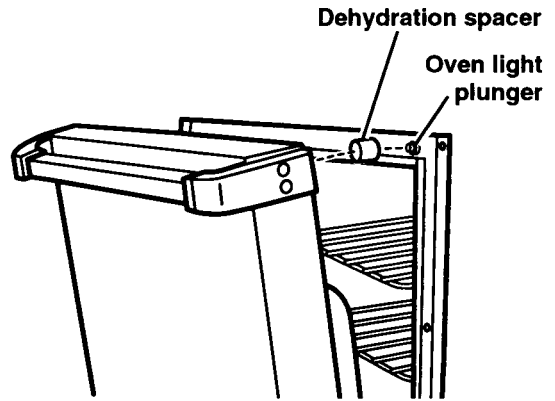

5. Open the door, then press and hold Convection Bake pad for 5 seconds.

PRESS



Hold for 5 seconds

YOU SEE

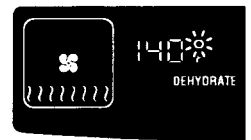

6. Set temperature (optional).

Do this step if you want to set a temperature (from 100°F to 200°F) other than 140°F.

NOTE: The 100°F setting will cause "RAISING BREAD" to be displayed. (See page 51 for more information on raising bread.)

PRESS

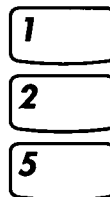

YOU SEE



(example shows 125°F dehydrating temperature)

Using and Caring for Your Oven

7. Start oven.

NOTES:

- If you want to change the dehydrating temperature after dehydrating has begun, repeat Steps 5, 6, and 7.
- The fan will be delayed for 1 minute to provide good ignition.

PRESS



YOU SEE

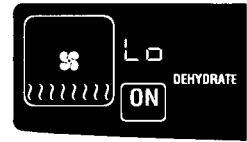

8. When dehydrating is done, turn off oven.

PRESS



YOU SEE

(display will go blank)

Raising (proofing) bread

You can use your THERMAL-CONVECTION™ oven to raise (proof) bread. For more information, see the convection oven cookbook provided with your range.

NOTE: If you do not turn off oven after proofing bread, the oven will keep running until you press the Cancel/Off pad.

1. Put dough in oven.

NOTE: Be sure to close the door.

2. Open the door, then press and hold Baked Goods pad for 5 seconds.

NOTE: If you enter a different temperature, you will enter the Dehydrating mode.

PRESS



Hold for
5 seconds

YOU SEE



3. Start oven.

One long tone will sound when oven is preheated.

PRESS



YOU SEE



4. When proofing is done, turn off oven.

PRESS



YOU SEE

(display will go blank)

Using and Caring for Your Oven



Cleaning your oven and controls

PART	WHAT TO USE	HOW TO CLEAN
Control knobs	Sponge and warm, soapy water	<ul style="list-style-type: none"> • Turn knobs to OFF and pull straight away from control panel. • Wash, rinse, and dry thoroughly. Do not soak. • Do not use steel wool or abrasive cleansers. They may damage the finish of the knobs. • Replace knobs. Make sure all knobs point to OFF.
Control panel	Sponge and warm, soapy water OR Paper towel and spray glass cleaner	<ul style="list-style-type: none"> • Wash, wipe with clean water, and dry thoroughly. • Do not use steel wool or abrasive cleansers. They may damage the finish. • Do not spray cleaner directly on panel. Apply cleaner to paper towel. <p>NOTE: Set the Control Lock to prevent the oven from accidentally turning on when you are cleaning the panel. (See "Using the control lock" on page 23.)</p>
Exterior surfaces (other than control panel)	Sponge and warm, soapy water	<ul style="list-style-type: none"> • Wash, wipe with clean water, and dry thoroughly. • Use nonabrasive, plastic scrubbing pad on heavily soiled areas. • Do not use abrasive or harsh cleansers. They may damage the finish.
Broiler pan and grid (clean after each use)	Steel-wool pad and warm, soapy water	<ul style="list-style-type: none"> • Wash, rinse, and dry thoroughly. • Do not clean the pan and grid in the Self-Cleaning cycle.
Oven racks	Steel-wool pad and warm, soapy water OR The Self-Cleaning cycle	<ul style="list-style-type: none"> • Wash, rinse, and dry thoroughly. <p>OR</p> <ul style="list-style-type: none"> • Leave in oven during Self-Cleaning cycle. <p>NOTE: Racks will permanently discolor and become harder to slide if left in oven during the Self-Cleaning cycle. Apply a small amount of vegetable oil to the side rungs to aid sliding.</p>

Using and Caring for Your Oven

PART	WHAT TO USE	HOW TO CLEAN
Oven door glass	Paper towel and spray glass cleaner OR Warm, soapy water, and a nonabrasive, plastic scrubbing pad	<ul style="list-style-type: none">• Make sure oven is cool.• Follow directions provided with the cleaner.• Wash, wipe with clean water, and dry thoroughly.
Oven cavity	Self-Cleaning cycle	<ul style="list-style-type: none">• Wipe up food spills containing sugar as soon as possible after the oven cools down. (See "Using the Self-Cleaning Cycle" on page 54.)• See "Using the Self-Cleaning Cycle" on pages 54-57.

Using and replacing the oven light(s)

Your oven may have a standard oven light or two side halogen lights. The oven light(s) will come on when you open the oven door. To turn the light(s) on when the oven door is closed, **press** the Oven Light pad  on the control panel. **Press** the pad  again to turn off the light(s).

Replacing the oven light (models with light on back wall):

1. **Disconnect** appliance at main power supply. Make sure the oven is cool before replacing the light bulb.

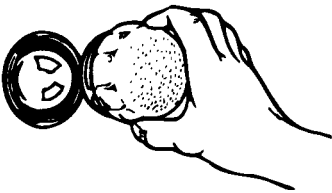

2. **Remove** the glass bulb cover in the back of the oven by screwing it out counter-clockwise.
3. **Remove** the light bulb from its socket. **Replace** the bulb with a 40-watt appliance bulb.
4. **Replace** the bulb cover by screwing it in clockwise. **Reconnect** appliance at main power supply.

NOTE: The oven light will not work during the Self-Cleaning cycle.

Replacing oven lights (models with side halogen lights):

1. **Disconnect** appliance at the main power supply. Make sure the oven is cool before replacing the light bulb.

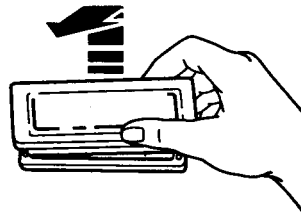

2. **Remove** glass light cover by grasping front edge of cover and pulling it away from the side wall of the oven.
3. **Remove** the light bulb from its socket. **Replace** the bulb with another halogen bulb (12 volt, 5 watt maximum, available at most hardware stores).
4. **Replace** the light cover by snapping it back into wall. **Reconnect** appliance at main power supply.

NOTE: The oven lights will not work during the Self-Cleaning cycle.

Using the Self-Cleaning Cycle

The Self-Cleaning cycle saves you from the toil and mess that often come with hand-cleaning the oven interior. Like the other functions of your oven, you operate the Self-Cleaning cycle with the easy-to-use electronic control. To use this cycle properly, follow the step-by-step instructions in this section.

	⚠ WARNING
	<p style="text-align: center;">Burn Hazard</p> <p>Do not touch the oven during the Self-Cleaning cycle.</p> <p>Keep children away from oven during Self-Cleaning cycle.</p> <p>Do not use commercial oven cleaners in your oven.</p> <p>Failure to follow these instructions can result in burns, or illness from inhaling dangerous fumes.</p>

Before you start

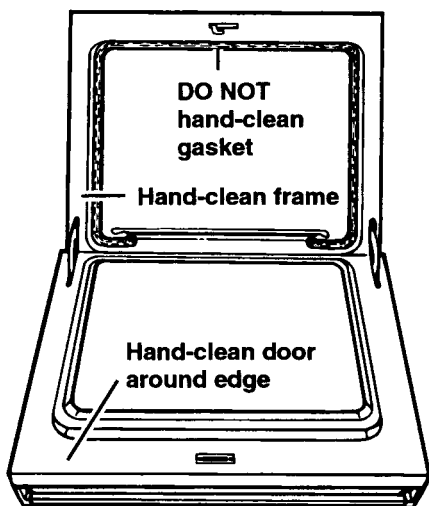

Before you start the Self-Cleaning cycle, make sure you:

- **Hand-clean the areas shown.** They do not get hot enough during the Self-Cleaning cycle for soil to burn away. Use hot water and detergent or a soapy steel-wool pad for cleaning.

NOTE: DO NOT clean, move, or bend the gasket. Poor cleaning, baking, and roasting may result.

- **Remove** the broiler pan and grid and anything else being stored in the oven.
- **Wipe out** any loose soil or grease. This will help reduce smoke during the Self-Cleaning cycle.

- **Wipe up** food spills containing sugar as soon as possible after the oven cools down. When sugar is heated to a high temperature in the Self-Cleaning cycle, the high temperature can cause the sugar to burn and react with the porcelain. This can cause staining and etching or pitting.
- **Remove** the oven racks from the oven if you want them to remain shiny. You can clean racks in the Self-Cleaning cycle, but they will discolor and become harder to slide. If you clean racks in the Self-Cleaning cycle, place them on the rack guides.
- **Heat and odors** are normal during the Self-Cleaning cycle. Keep the kitchen well ventilated by opening a window or by turning on a vent hood or other kitchen vent during the cycle.

NOTES:

- **Do not block** the vent during the Self-Cleaning cycle. Air must move freely for best cleaning results.
- **Do not leave** plastic utensils on the cooktop. They may melt.
- **Do not leave** any foil in oven during the Self-Cleaning cycle. Foil could burn or melt and damage the oven surface.
- **The oven light** will not work during the Self-Cleaning cycle.

Using the Self-Cleaning Cycle

- **Do not insert** any object into the opening of the protective shield that surrounds the ignitor. Also, do not clean this area. Doing either could result in product damage.
- **Do not use** your cooktop during the Self-Cleaning cycle. Using your cooktop will turn the cycle off.

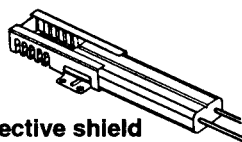

Protective shield
around ignitor

Before setting the controls

- **Make sure clock is set to correct time of day.**
- **Make sure the oven door is completely closed.**

Setting the controls

To start cleaning immediately:

1. Press Clean pad.

A 3½-hour Self-Cleaning cycle will be set. (The first 3 hours are for cleaning, the last 30 minutes are for cooling.)

PRESS



YOU SEE



(stop time display shows time 3½ hours later than time of day – shown in start time display)

2. Set cleaning time (optional).

If you want a Self-Cleaning cycle other than 3½ hours, **press** the desired Number pads for the new time up to 4½ hours.

- **Use 2½ hours** for light soil.
- **Use 3½-4½ hours** for moderate to heavy soil.

PRESS

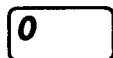
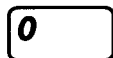
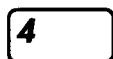

YOU SEE



(example shows 4-hour cleaning cycle with stop time now 4 hours later than time of day)

3. Start oven.

NOTE: The door will lock right after you press START.

PRESS



YOU SEE



(for first 30 minutes)



(for remainder of cycle)

continued on next page

Using the Self-Cleaning Cycle

4. After the Self-Cleaning cycle ends:

YOU SEE



To delay cleaning start time:

1. Press Clean pad.

A 3½-hour Self-Cleaning cycle will be set. (The first 3 hours are for cleaning, the last 30 minutes are for cooling.)

PRESS



YOU SEE



(stop time display shows time 3½ hours later than time of day – shown in start time display)

2. Set cleaning time (optional).

If you want a Self-Cleaning cycle other than 3½ hours, **press** the desired Number pads for the new time up to 4½ hours.

- Use 2½ hours for light soil.
- Use 3½-4½ hours for moderate to heavy soil.

PRESS

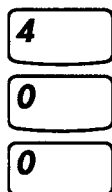

YOU SEE



(example shows 4-hour cleaning cycle with stop time now 4 hours later than time of day)

3. Press Stop Time pad.

PRESS



YOU SEE



4. Set Stop time.

Example for 7:00:

PRESS

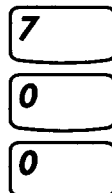

YOU SEE



(display shows stop time of 7:00 and start time of 3:00 – stop time minus cleaning time)

5. Complete entry.

NOTE: The door will lock right after you press START.

PRESS



YOU SEE



Using the Self-Cleaning Cycle

When the start time is reached:

NOTE: After 30 minutes, the broil burner symbol will turn off and the bake burner symbol will turn on.

YOU SEE



6. After the Self-Cleaning cycle ends:

NOTE: You can run a second Self-Cleaning cycle right after "DOOR LOCKED" disappears from the display.

YOU SEE



To stop the Self-Cleaning cycle at any time:

PRESS



YOU SEE



("DOOR LOCKED" will appear if oven has not cooled down)

For best cleaning results

- **After the oven cools to room temperature**, wipe up any residue or ash with a damp cloth or sponge. If any spots remain, clean with a mild abrasive cleanser or cleaning sponge.
- **Clean the oven** before it gets heavily soiled. Cleaning a very soiled oven takes longer and results in more smoke than usual.
- **If the Self-Cleaning cycle does not get the oven as clean as you expected**, the cycle may not have been set long enough or you may not have prepared the oven properly. Set the Self-Cleaning cycle longer the next time and hand-clean areas noted on page 54.

How the cycle works

The Self-Cleaning cycle uses very high heat to burn away soil and grease. During the cycle, the oven gets much hotter than it does for normal baking or broiling. This high heat breaks up the soil or grease and burns it away.

Your oven is preset for a 3½-hour Self-Cleaning cycle. However, you can adjust the cycle time to the amount of soil in your oven. You can set the cycle anywhere between 2½ and 4½ hours. (See "Setting the controls" on page 55.)

The graph at the right is representative of a normal, 3½-hour Self-Cleaning cycle. Note that the heating stops after 3 hours, but it takes longer for the oven to cool enough to unlock.

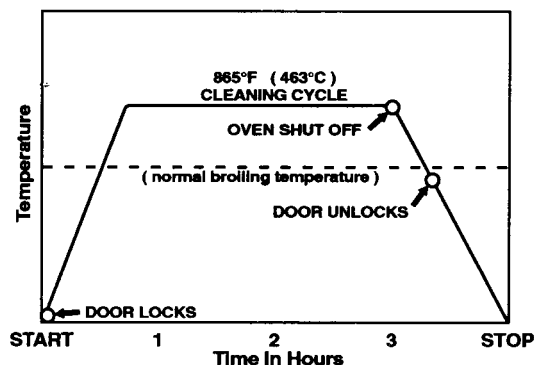

Troubleshooting

Most cooking problems often are caused by little things you can find and fix without tools of any kind. Check the lists below and on the next two pages before calling for assistance or service. If you still need help, see "Requesting Assistance or Service" on page 61.

If nothing operates, check the following:

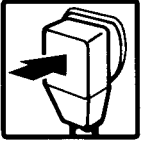

Is the range plugged or wired into a live outlet or circuit with the proper voltage?
(See Installation Instructions.)

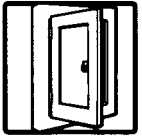

Have you blown a household fuse or tripped a circuit breaker?

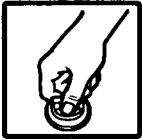

Have you set the control knob or electronic control correctly?

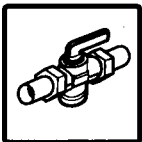

Is the range properly connected to gas supply? Contact an authorized KitchenAid servicer to reconnect range to gas supply. (See Installation Instructions.)



Is the flow of combustion and/or ventilation air to the cooktop blocked?

Other problems and their causes:

PROBLEM	CAUSE
The oven will not operate	<ul style="list-style-type: none"> • You have not set the electronic control correctly. Refer to the section in this manual describing the function you are operating. • You have programmed a delayed start time. Wait for the start time to be reached or cancel and reset the control.
Burner fails to light	<ul style="list-style-type: none"> • The range is not plugged or wired into a live outlet or circuit with the proper voltage. (See Installation Instructions.) • You have blown a household fuse or tripped a circuit breaker. In case of prolonged power failure, manually light burners. (See page 14.) • The burner ports are clogged. Clean with a straight pin. (See page 16.)
Burner flames are uneven	<ul style="list-style-type: none"> • The burner ports are clogged. Clean with a straight pin. (See page 16.) If this fails, call for service.
Burner flames lift off ports, are yellow, or are noisy when turned off	<ul style="list-style-type: none"> • The air/gas mixture is incorrect. Contact a service technician to check it.
Burner makes popping noise when on	<ul style="list-style-type: none"> • The burner is wet from washing. Let dry.
Burners spark	<ul style="list-style-type: none"> • It is normal for all four burners to spark briefly when: <ul style="list-style-type: none"> – A burner is turned on, but has not yet ignited. – There is a draft blowing on burners. – A very large pot on burner causes flame to be unstable. No action is needed. Burner operation is not affected and the sparking should end when the ignited flame is burning undisturbed. • Continuous sparking may be caused when: <ul style="list-style-type: none"> – A spillover has wet ignition switch contacts. Turn on one or two burners or disconnect electrical supply to let switch dry out. – There is a faulty spark module. Contact a service technician to replace module. – The wall outlet wiring is incorrect. Contact a qualified electrician to correct wiring, if needed.
Cooling fan runs during Bake or Broil	<ul style="list-style-type: none"> • It is normal for the fan to automatically run during Bake or Broil to cool the electronic control.

Troubleshooting

PROBLEM	CAUSE
The control knob(s) will not turn	<ul style="list-style-type: none"> • You are not pushing in before turning.
The Self-Cleaning cycle will not operate	<ul style="list-style-type: none"> • You have programmed a delayed start time. Wait for the start time to be reached or cancel and reset the control. • The cooling fan is not running. If fan is running, you can hear it. Call a KitchenAid service technician for repair.
Cooking results are not what you expected	<ul style="list-style-type: none"> • The range is not level. (See Installation Instructions.) • The oven temperature seems too low or too high. See "Adjusting oven temperature" on page 33 to adjust oven temperature. • You did not preheat the oven before baking (if called for in recipe). • The recipe you are using may need to be altered to improve the taste or appearance of the food. • You are using a pan that is not the correct type or size. Refer to a reliable cookbook or recipe for recommended pan type and size. • There is not enough air space around pan when baking. Allow 1½ to 2 inches of air space on all sides of pan. • The cookware is too large or too small for the surface burner being used. Pan should be the same size or slightly larger than the surface burner being used. • The flame is not the correct size for the cookware being used.
The display is showing "PF"	<ul style="list-style-type: none"> • There has been a power failure. Reset the clock. (See page 25.)
A letter followed by a number shows on the display (for example "E3", "F1")	<ul style="list-style-type: none"> • Press CANCEL/OFF. If the code does not disappear, call for service. (See Step 2 on page 61.) • The power cord is not properly grounded. (See Installation Instructions.)
The key pads do not operate	<ul style="list-style-type: none"> • The Control Lock has been set. (See "Using the control lock" on page 23.) Turn off the Control Lock by pressing and holding the Control Lock pad (Number Pad 3) for 5 seconds. • The Sabbath mode has been set ("SAbb" appears on the display). Turn off the Sabbath mode by opening the oven door, waiting up to 15 seconds and pressing and holding Number Pad 6 for 5 seconds. • The range is not grounded. Call a KitchenAid service technician to ground the range.

If none of these items was causing your problem, see "Requesting Assistance or Service" on page 61.

Requesting Assistance or Service

1. If the problem is not due to one of the items listed in "Troubleshooting" on pages 58-60*:

- Call the KitchenAid Consumer Assistance Center:



1-800-422-1230

One of our trained consultants can instruct you in how to obtain satisfactory operation from your appliance or, if service is necessary, recommend a qualified service company in your area.

- If you prefer, write to:

KitchenAid Brand Home Appliances
Consumer Assistance Center
c/o Correspondence Dept.
2000 North M-63
Benton Harbor, MI 49022-2692

Please include a daytime phone number in your correspondence.

2. If you need service*:

- Call your dealer or the repair service he recommends.



- All service should be handled locally by the dealer from whom you purchased the unit or an authorized KitchenAid servicer.

- If you are unable to obtain the name of a local authorized KitchenAid servicer, call our Consumer Assistance Center telephone number (see Step 1).

3. If you are not satisfied with the action taken:

- Contact the Major Appliance Consumer Action Program (MACAP). MACAP is a group of independent consumer experts that voices consumer views at the highest levels of the major appliance industry.
- Contact MACAP only when the dealer, authorized servicer, and KitchenAid have failed to resolve your problem.

Major Appliance Consumer Action Program
20 North Wacker Drive
Chicago, IL 60606

- MACAP will in turn inform us of your action.

* When asking for help or service:

Please provide a detailed description of the problem, your appliance's complete model and serial numbers, and the purchase date. (See page 3.) This information will help us respond properly to your request.

Don't forget, KitchenAid offers a full line of quality home appliances.

Built-In Refrigerators

Trash Compactors

Ranges & Cooktops

Freestanding Refrigerators

Hot Water Dispensers

Microwave Ovens

50-Pound Ice Makers

Food Waste Disposers

Washers & Dryers

Dishwashers

Built-In Ovens

Mixers & Blenders

For more information on these appliances, or the one you have purchased, call our toll-free Consumer Assistance Center telephone number, **1-800-422-1230**.

Index

This index is alphabetical. It contains all the topics included in this manual, along with the page(s) on which you can find each topic.

TOPIC	PAGE	TOPIC	PAGE
ANTI-TIP BRACKET	11	COOKWARE	
ASSISTANCE	61	Canning	15
BAKING		Pans	15
Aluminum foil	6, 31	DEHYDRATING	49
Pans	30	EASY CONVECT™ Conversion	39
Setting cycle	28	ENERGY SAVING TIPS	15
Tips	30, 31	FEATURES	8, 9
BROILING		LIGHT(S)	
Chart	45	Cooktop	19
Grid	42	Oven	53
Pan	42	Surface	19
Setting cycle	42	LOCK	
Tips	44	Control	23
CLEANING		Self-cleaning cycle	55, 56
Cooktop	18	MODEL AND SERIAL NUMBER	3
Oven	52, 53	OVEN TEMPERATURE	
Self-cleaning	54	Adjusting	33
CONTROL PANEL		Setting	24, 28, 29, 35, 38, 39, 42, 43, 46, 48, 50
Canceling	22	PARTS	8, 9
Clock	25	PROOFING BREAD	51
Command pads	21	RACKS	
Control lock	23	Convection roasting rack	32
Display	21	Placement	31
Number pads	21	Positions	31
Power failure	23	ROASTING	
Sabbath feature	23	Rack	32
Settings	24, 25	Setting cycle	29
Signals	22	Tips	32
Starting	22	SAFETY	4-7
Timer	26	SELF-CLEANING	
Tones	22	Delay cleaning	56
CONVECT FULL MEAL	37	How cycle works	57
CONVECTION BAKING		Preparing oven	54
Pans	30	Setting controls	55
Setting cycle	39	Starting immediately	55
Tips	31	Stopping cycle	57
CONVECTION BROILING	43	Tips	57
COOKTOP		SERVICE	61
Caring for	16		
Cleaning	18		
Using	12-14		

Index

TOPIC	PAGE	TOPIC	PAGE
STORAGE DRAWER		Power failure	14
Removing	10	When to use	12
Replacing	10	TEMPERATURE PROBE	
SURFACE BURNERS		Cleaning	36
Caps	16, 18	Connecting to oven	34
Control knobs	13, 18	Inserting in food	34
Flame	14, 16, 17	Setting cycle	35
Gas tube openings	16	TIMED COOKING	
Grates	18	Canceling	49
Heat settings	13, 14	Cook time	47, 48
How they work	12, 13	Stop time	48
How to use	13, 14	TROUBLESHOOTING	58
Ignitors	13	WARRANTY	64
L.P. gas conversion kit	12		
Ports	16, 17		

KitchenAid®

Gas Range

Warranty

LENGTH OF WARRANTY:	KITCHENAID WILL PAY FOR:	KITCHENAID WILL NOT PAY FOR:
ONE-YEAR FULL WARRANTY FROM DATE OF PURCHASE.	Replacement parts and repair labor costs to correct defects in materials or workmanship. Service must be provided by an authorized KitchenAid servicing outlet.	A. Service calls to: <ol style="list-style-type: none"> 1. Correct the installation of the range. 2. Instruct you how to use the range. 3. Replace house fuses or correct house wiring. 4. Correct house plumbing.
SECOND-THROUGH FIFTH-YEAR LIMITED WARRANTY FROM DATE OF PURCHASE.	Replacement parts for any gas burner to correct defects in materials or workmanship. Replacement parts for solid state touch control system to correct defects in materials or workmanship.	B. Repairs when range is used in other than normal home use. C. Damage resulting from accident, alteration, misuse, abuse, improper installation, or installation not in accordance with local electrical or plumbing codes. D. Any labor costs during the limited warranties.
SECOND-THROUGH TENTH-YEAR LIMITED WARRANTY FROM DATE OF PURCHASE.	Replacement parts for the porcelain oven cavity/inner door if the part rusts through due to defects in materials or workmanship.	E. Replacement parts or repair labor costs for units operated outside the United States. F. Pickup and delivery. This product is designed to be repaired in the home. G. Repairs to parts or systems caused by unauthorized modifications made to the appliance.

7/95

KITCHENAID DOES NOT ASSUME ANY RESPONSIBILITY FOR INCIDENTAL OR CONSEQUENTIAL DAMAGES. Some states do not allow the exclusion or limitation of incidental or consequential damages, so this exclusion or limitation may not apply to you. This warranty gives you specific legal rights, and you may also have other rights which vary from state to state.

Outside the United States, a different warranty may apply. For details, please contact your authorized KitchenAid dealer.

If you need service, first see the "Troubleshooting" section of this book. After checking "Troubleshooting," additional help can be found by checking the "Requesting Assistance or Service" section or by calling our Consumer Assistance Center telephone number, **1-800-422-1230**, from anywhere in the U.S.A.

KitchenAid
 Benton Harbor, Michigan 49022-2692

PART NO. 9751683 Rev. E