

Installation Instructions

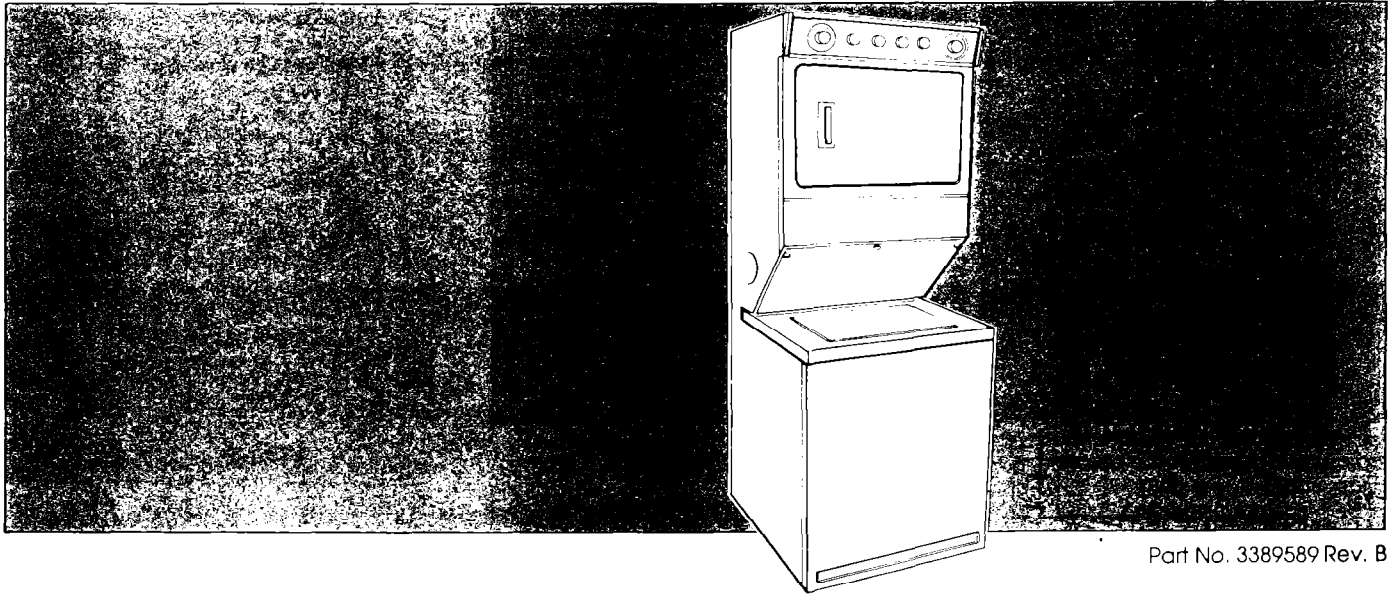

Part No. 3389589 Rev. B

Large Capacity Thin Twin Washer • Dryer Four-Wire 240 Volt

IMPORTANT

Installer: Leave Installation Instructions with the homeowner.

Homeowner: Keep Installation Instructions for future reference.

Save Installation Instructions for local electrical inspector's use.



Before you start...

Check location where washer/dryer will be installed. Proper installation is your responsibility. Make sure you have everything necessary for correct installation.

Grounded electrical outlet is required. (See "Electrical requirements".)

Standpipe drain system needs a two-inch diameter standpipe with a minimum carry-away capacity of 17 gallons per minute. The top of the standpipe must be at least 34 inches high and no higher than 72 inches from the floor.

Floor drain system requires a siphon break, Part No. 285320, available from Whirlpool authorized parts distributor.

Dryer may be exhausted from the rear or left or right side. Exhausting through the side requires Part No. 3391335. (See "Exhaust requirements", Panel B.)

Four-inch metal exhaust duct is required.

Important: Observe all governing codes and ordinances.

Check code requirements. Some codes do not permit or limit the installation of clothes dryers in garages, closets, mobile homes and sleeping quarters. Contact your local building inspector.

Protection from weather: Do Not store or operate washer/dryer below 32°F (some water may remain in washer). Proper operation of dryer cycles requires temperatures above 45°F. See **Use & Care Guide** for "Winterizing" information.

Water heater: Set to deliver 140°F water to the washer.

Laundry tub drain system: needs at least a 20-gallon laundry tub. Top of tub must be at least 34 inches high and no higher than 72 inches from floor.

If a longer drain hose is needed, drain hose, Part No. 388423, and hose extension kit, Part No. 285442 are available from Whirlpool authorized parts distributors.

Location should be large enough so dryer door can open fully - at least 90°. (See back cover for "Recessed and closet installation instructions" and "Product dimensions".)

SEE RECESSED AREA INSTRUCTIONS ON BACK COVER.

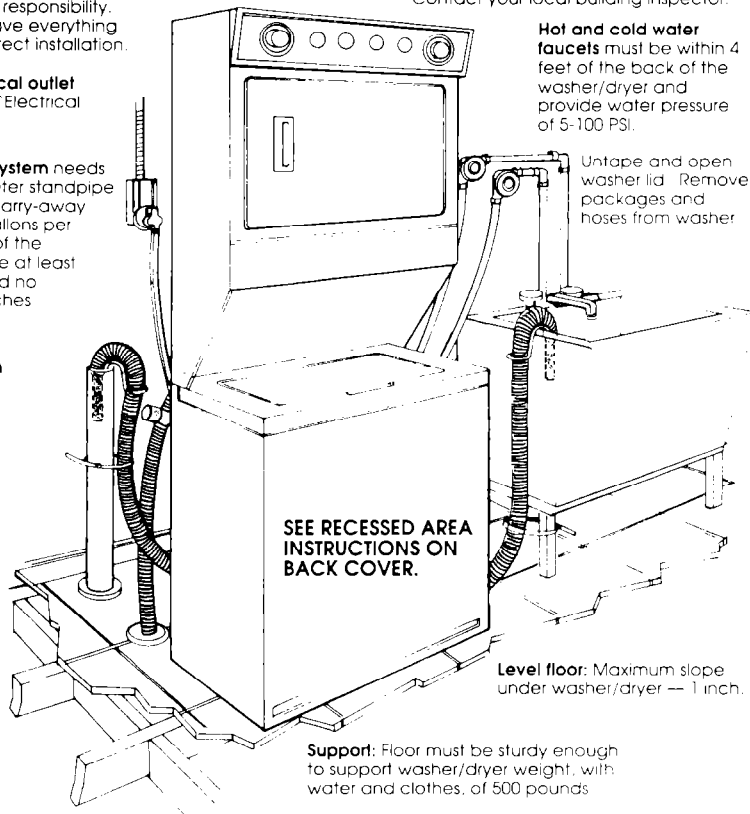

⚠ WARNING

Fire Hazard

- Do Not use or store gasoline, paint, thinners and other flammable materials near washer/dryer. Fumes from such materials could result in fire or explosion.
- Never install washer/dryer up against draperies or curtains or on carpet. To do so may result in a fire.
- Keep any and all items from falling or collecting behind the washer/dryer. Failure to do so may result in a fire.
- Replace all access panels before operating washer/dryer. Failure to do so may result in a fire or electrical shock.

Tools and materials needed for installation:

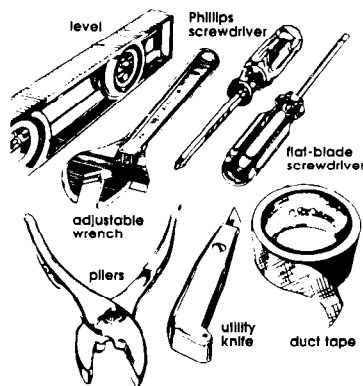

Panel A

Electrical requirements

⚠ WARNING

Electrical Shock Hazard

- Electrical ground is required on this product.
- Improper connection of the equipment-grounding conductor can result in electrical shock.
- Check with a qualified electrician if you are in doubt as to whether the appliance is properly grounded.
- Do Not modify the power supply cord plug. If it will not fit the outlet, have a proper outlet installed by a qualified electrician. Modifying the power supply cord plug could result in electrical shock.
- Use a new 30-ampere power supply cord kit. Do Not reuse an old power supply cord. Possible electrical shock or fire hazard could occur if old power supply cord is used.
- Do Not use an extension cord with this appliance. Such use may result in a fire, electrical shock or other personal injury.
- Do Not have a fuse in the neutral or grounding circuit. This could result in electrical shock.

1. A three-wire, single phase, 120/240-volt, 60-Hz, AC only, electrical supply, with a fourth wire as a grounding wire, (or three-wire, 120/208-volt electrical supply with a fourth wire as a grounding wire if specified on nameplate) is required on a separate 30-ampere circuit, fused on both sides of the line. The fourth (grounding) conductor must be identified by a green or green/yellow cover and the neutral conductor by a white cover. (Time-delay fuse or circuit breaker is recommended.)

It is the personal responsibility of the customer to contact a qualified installer to assure that the electrical installation is adequate and in conformance with the National Electrical Code ANSI/NFPA 70 - latest edition, and local codes and ordinances.

3/4", U.L.-listed strain relief

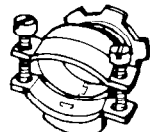
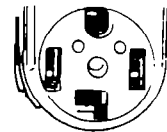

Figure 1

2. This washer/dryer is equipped with a 30-amp-rated, four-wire, flexible-type, power supply cord (pigtail) and a 3/4", U.L.-listed strain relief. (See Figure 1.) Where local codes permit, it must be plugged into a mating, 30-amp receptacle (NEMA Type 14-30R). (See Figure 2.)



(14-30R) 4-wire receptacle
Typical 30-amp receptacle; use where local codes permit flexible-type power supply cord (pigtail).

Figure 2

3. IF THE POWER SUPPLY CORD IS REMOVED, THE WASHER/DRYER MUST BE CONNECTED WITH 10-GAUGE MINIMUM, COPPER WIRE ONLY. (See Panels F and G, "Alternate electrical connection", for detailed instructions.)

4. The power supply cord (pigtail) can be removed and the appliance can be connected directly to an individual, 30-ampere, fuse or circuit breaker box through flexible, armored or non-metallic sheathed, 10-gauge minimum, copper cable. It is the personal responsibility and obligation of the customer to

contact a qualified electrician to assure that the electrical installation is adequate and is in conformance with National Electrical Code ANSI/NFPA 70-latest edition, and local codes and ordinances.

Allow slack in the line between the wall and the appliance so that it can be moved if servicing is ever necessary. A 3/4", U.L.-listed strain relief must be provided at each end of the power supply cable (at the appliance and at the junction box).

(10-30R)

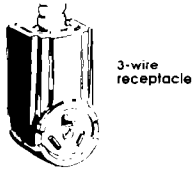

Figure 3

5. If you must change to a three-wire, single phase, 120/240-volt, 60-Hz, AC only, electrical supply system, and local codes permit, a U.L.-listed, 120/240-volt minimum, 30-ampere, dryer power supply cord kit with a receptacle of NEMA Type 10-30R may be used. (See Figure 3.) This cord must contain three, No.-10 copper conductors with ring terminals or spade terminals with upturned ends on the washer/dryer end. Where local codes permit, it must be plugged into a mating 30-amp receptacle (NEMA type 10-30R). Cord should be Type SRD or SRDT and be at least four feet long. The three-wire power supply cord is not provided with the washer/dryer. A kit, Part No. 687104, is available from your Whirlpool dealer.

NOTE: If local codes require permanently connected wiring, see "Alternate electrical connection", Panels F and G.

To convert to three-wire electrical system, the four-wire power supply cord must be removed and the appliance cabinet must be grounded according to local codes either by using the neutral terminal or a separate grounding wire. (See Panel F, "Alternate electrical connection", for detailed instructions.)

Exhaust requirements

⚠ WARNING

Fire Hazard

- Do Not use non-metal, flexible duct.
 - Do Not use metal duct smaller than four inches in diameter.
 - Do Not use exhaust hoods with magnetic latches.
- Improper air supply for exhausting may result in a fire.
- Check that exhaust system is not longer than specified. Exhaust systems longer than specified will:
 - Accumulate lint.
 - Shorten the life of the product.
 - Reduce performance. Result in longer drying times and increase energy usage.
 - Failure to follow specifications may result in a fire.
 - Do Not exhaust dryer into a chimney, furnace cold air duct, attic or crawl space, or any other duct used for venting.
 - Clean the exhaust system every other year.
 - Do Not install flexible duct under wall, ceiling or floor materials.
- Accumulated lint could result in a fire or cause moisture damage.

Use duct tape to seal all joints.

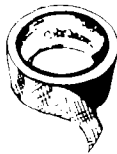

Four-inch, rigid, metal pipe is preferred. Plan installation to use the fewest number of elbows and turns.

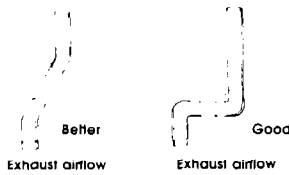

Metal, flexible duct must be fully extended and supported when the dryer is in its final position. DO NOT KINK OR CRUSH THE DUCT. The metal flexible duct must be completely open to allow adequate exhaust air to flow.

Allow as much room as possible when using elbows or making turns. Bend duct gradually to avoid kinking. Remove excess, flexible duct to avoid sagging and kinking that may result in reduced airflow.

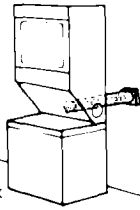

The exhaust duct can be routed up, down, left, right or straight out the back of the washer/dryer. Space requirements are provided on the back cover of Installation Instructions and on the rear panel of the washer/dryer.

Maximum length of the exhaust system depends upon the type of duct used, number of elbows and the type of exhaust hood. The maximum length for both rigid and flexible duct is shown in chart.

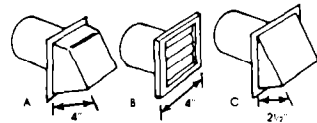

Rear, Side or Bottom Exhaust

NUMBER OF 90° TURNS	A	B	C	
0	42 FT.	42 FT.	32 FT.	MAXIMUM LENGTH OF 4" DIA. RIGID METAL DUCT.
1	34 FT.	34 FT.	24 FT.	
2	26 FT.	26 FT.	16 FT.	
0	26 FT.	26 FT.	26 FT.	MAXIMUM LENGTH OF 4" DIA. FLEXIBLE METAL DUCT.
1	21 FT.	21 FT.	21 FT.	
2	16 FT.	16 FT.	16 FT.	

For exhaust systems not covered by the exhaust length chart, see Whirlpool Service Manual, "Exhausting Whirlpool Dryers," Part No. 603197, available from your Whirlpool parts distributor.

Service check: The back pressure in any exhaust system used must not exceed 0.6 inches of water column measured with an incline manometer at the point that the exhaust duct connects to the dryer.

Exhausting the dryer outside is recommended. A closet installation must be exhausted outside. Recessed installation that is not exhausted outside must use Exhaust Deflector Part No. 694609 available from your Whirlpool dealer. (See "Recessed and closet installation

instructions" on the back cover for adequate unobstructed air opening requirements.)

If the washer/dryer is installed in a confined area such as a bedroom, bathroom, or closet, it must be exhausted to the outside and provision must be made for enough air for combustion and ventilation. Check governing codes and ordinances. Also refer to the Recessed and closet installation instructions on the back cover.

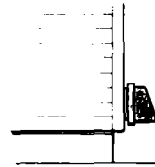

An exhaust hood should cap the exhaust duct to prevent exhausted air from returning into the dryer. The outlet of the hood must be at least 12" from the ground or any object that may be in the path of the exhaust.

4-inch outlet hood is preferred. However, a 2-1/2 inch outlet exhaust hood may be used. A 2-1/2 inch outlet creates greater back pressure than other hood types.

Exhausting the dryer through the side of the washer/dryer requires the use of Side Exhaust, Part No. 3391335. Follow kit installation instructions for proper exhaust installation.

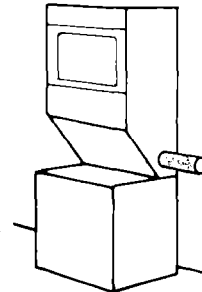

⚠ WARNING

Fire Hazard

Exhausting your dryer indoors is not recommended. The moisture and lint indoors may cause:

- FIRE HAZARD from lint collected in dryer;
- Moisture damage to woodwork, furniture, paint, wallpaper, carpet, etc.;
- House-cleaning problems and possible health problems.

Failure to follow the above precaution could result in fire, personal injury or property damage.

Mobile Home Installation

This appliance is suitable for mobile home installations. The installation of the washer/dryer must conform to the Manufactured Home Construction and Safety Standard, Title 24 CFR, Part 3280 (formerly the Federal Standard for Mobile Homes Construction and Safety, Title 24, HUD Part 280, 1975) or latest edition.

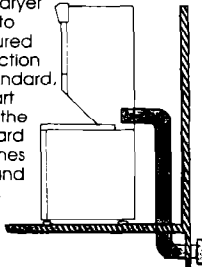

Mobile home exhaust requirements: The washer/dryer must have an outside exhaust. If the dryer is exhausted through the floor and the area under the mobile home is enclosed, the exhaust system must terminate outside the enclosed area. Extension beyond the enclosure will prevent lint and moisture buildup under the mobile home.

Now start...

with washer/dryer in laundry area.

⚠ WARNING

Personal Injury Hazard
More than one person is required to lift, tilt or move the washer/dryer because of its weight and size. Failure to follow these instructions may result in personal injury.

Truck only from the rear to prevent product damage.

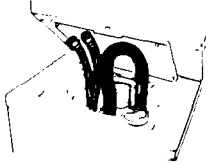

1. Open washer lid. Take hoses and parts packages out of basket. Close lid.

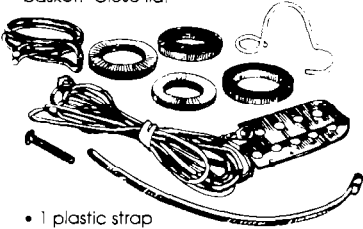

- 1 plastic strap
- 1 hose clamp
- 1 wire form
- 4 flat, water-hose washers
- 1 grounding wire assembly

2. Remove parts from package. Check that all parts were included.

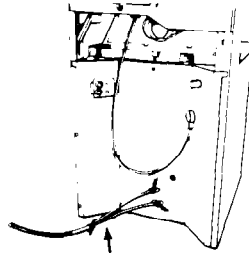

Pull the yellow shipping strap completely out of the washer/dryer.

3. Remove the label that covers the yellow shipping strap. Pull to completely remove the shipping strap from the inside of the washer/dryer.

Use new hoses and washers that came with your washer/dryer.

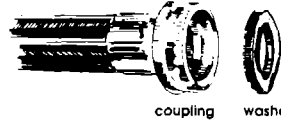

4. Insert a flat washer into each end of the inlet hoses. Check that washers are firmly seated in couplings.

Inlet valves are plastic. Do Not strip or crossthread.

5. Attach one hose to the bottom inlet valve. Then attach the second hose to the top inlet valve. Tighten couplings by hand; then use pliers to make an additional two-thirds turn.

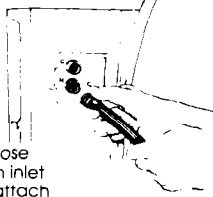

6.

Slide nozzle end of drain hose through the small "loop" in the wire form. Wrap the hook end of the wire form around the drain hose to form a "hook" shape.

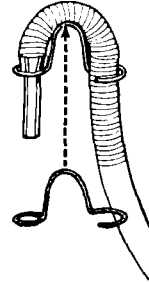

Do Not force excess length of drain hose down the standpipe. This could cause siphoning.

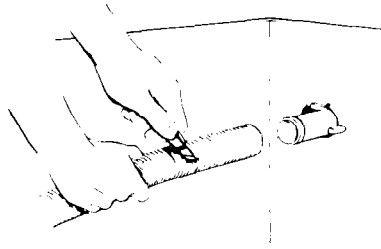

7.

Put "hook" end of drain hose into laundry tub or standpipe. Estimate length of drain hose needed when washer/dryer is in final position. If the drain hose is too long — remove clamp and coupling; cut flexible end of hose. (Do Not cut hook-shaped end of drain hose.) Push and twist coupling securely onto drain nose. (You should feel top of drain hose through coupling.) Slide clamp over coupling and hose.

9.
17.

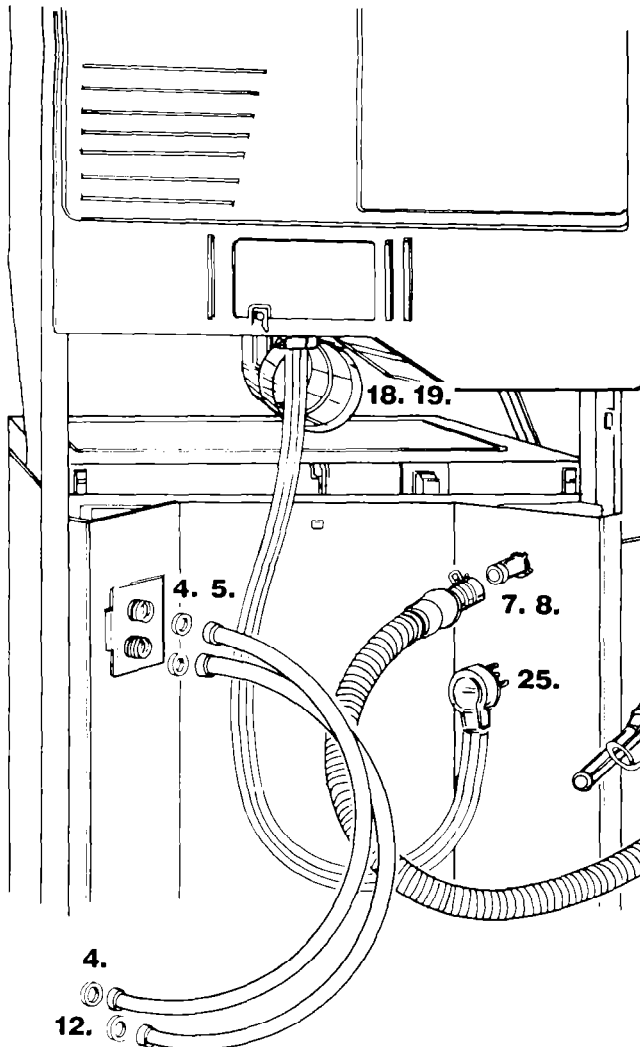

3.

Pull yellow shipping strap with 3 cotterpins completely out of washer/dryer.

Install wire form on drain hose.

6. 16.
10.

Numbers correspond to steps.

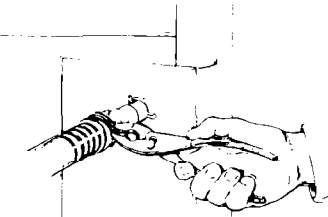

8. Place hose clamp over washer drain connector. Push coupling end of drain hose on to washer connector. Use pliers to open clamp and slide clamp over drain hose. Check for good fit.

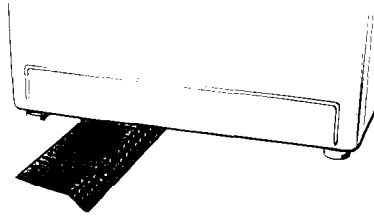

Insert corner posts or other type of support 6 inches from left leg. Do Not insert corner posts in the center of the washer/dryer.

14. If it is not level, carefully tilt washer/dryer backward until front of washer/dryer is 3-4 inches off of the floor. Insert 4 corner posts under washer/dryer about six inches from the left leg. Loosen nuts on each front leg. Adjust the front legs up or down. Tilt washer/dryer backward and remove corner posts. Gently lower the washer/dryer to the floor. Repeat Step 13. If it is still not level, repeat Step 14 and then Step 13 until washer/dryer is level.

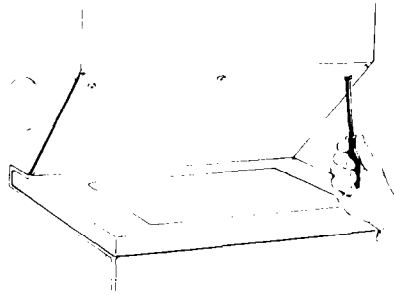

17. If you did not remove the access panel in Step 9, do so by removing three Phillips-head screws and one bumper, located at the top of the access panel. Set panel, screws and bumper aside.

18. Determine the length of exhaust duct that is needed to connect the dryer to the exhaust hood. (See "Exhaust requirements", Panel B.) Connect the exhaust duct to the washer/dryer and then to the exhaust hood.

CAUTION
Floor Damage
Slide washer/dryer onto cardboard or hardboard before moving across floor. Failure to do so may cause damage to floor covering.

9. If you have room to work from either side of the washer/dryer, move washer/dryer close to final position so you can easily complete the following steps. Go to Step 10.

If you are working in a closet or recessed area, move the washer/dryer into its final position and remove cardboard or hardboard from under washer/dryer. Remove access panel by removing three Phillips-head screws and one bumper, located at the top of the access panel. Set panel, screws and bumper aside. (See Step 17, Panel D.) Complete the following steps through the access area.

10. Put the "hook" end of the drain hose back in the laundry tub or standpipe. Check for proper length of drain hose. If drain hose is too long, disconnect and repeat Steps 7 and 8.



11. Before attaching water inlet hoses, run water through both faucets into a bucket. This will get rid of particles in the water lines that might clog the hoses.

12. Attach bottom hose (inlet marked "H") to hot water faucet. Attach top hose (inlet marked "C") to cold water faucet. Tighten the coupling to the faucet by hand. Use pliers to make final two-thirds turn.

Move washer/dryer to its permanent location. Remove cardboard from under washer/dryer.

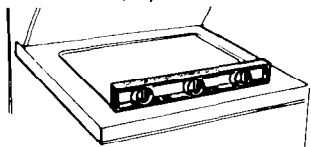

13. Tilt washer/dryer forward raising back legs 1" off of floor to automatically adjust rear self-leveling legs. Gently lower washer/dryer to floor. Check levelness of the washer/dryer by placing a carpenter's level on top of the washer, first side to side, then front to back. If washer/dryer is level, go to Step 15.

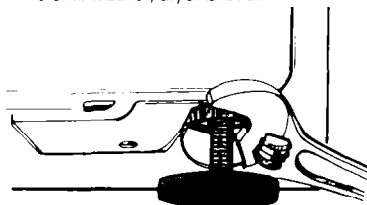

15. When washer/dryer is level, use wrench to turn nuts on front legs up tightly against washer/dryer base. If nuts are not tight against washer/dryer base, the washer/dryer may vibrate.

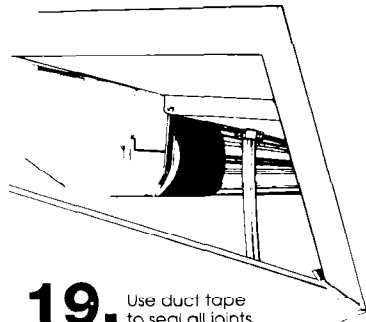

19. Use duct tape to seal all joints.

20. CHECK ELECTRICAL REQUIREMENTS. BE SURE YOU HAVE CORRECT ELECTRICAL SUPPLY AND RECOMMENDED GROUNDING METHOD. Check the installation instructions to see that you have completed each step. Complete any missed steps before you continue.

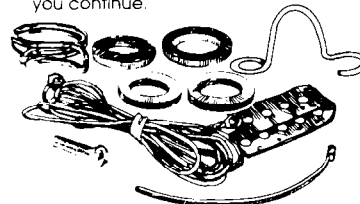

21. Check that all parts are now installed. (See parts list, Panel C.) If there is an extra part, go back through steps to see which step was skipped.

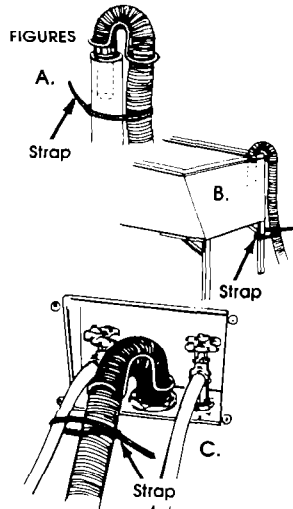

CHECK THAT HOSE IS NOT TWISTED OR KINKED AND IS SECURELY IN PLACE.

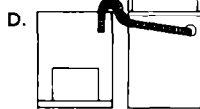

Note: If washer/dryer is moved to adjust drain hose, the washer/dryer must be leveled again. Repeat Steps 13-15.

16. Secure drain hose to tub or standpipe by wrapping the plastic strap around the hose as shown in Figures A-C. If drain hose cannot be strapped in place, it must be cut exactly to length so that the "hook" end is held tightly over the edge of the tub or standpipe as shown in Figure D.

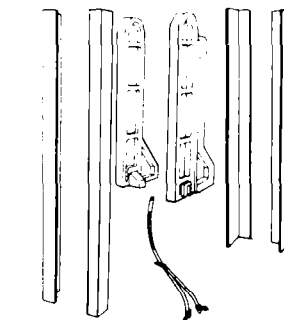

22. Check that you removed all the shipping pieces, including the yellow shipping strap with its 3 cotterpins. Dispose of all materials in the proper manner. If you do not remove the yellow shipping strap, your washer/dryer may "walk" away from its location.

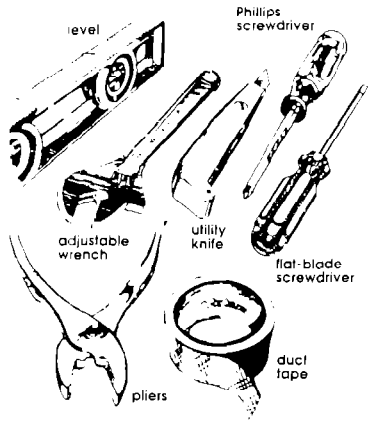

If washer/dryer does not operate properly...

Check the following to be sure that:

1. Electrical supply is connected.
2. House fuse or circuit breaker is intact and tight.
3. Washer lid or dryer door is closed.
4. Controls are set in a running or "ON" position.
5. Dryer "start" button has been firmly pushed.
6. Make sure yellow, shipping strap has been completely removed.

During normal business hours the Whirlpool COOL-LINE® Service will answer any questions about operating or maintaining your washer/dryer not covered in your Installation Instructions. The Whirlpool COOL-LINE® Service number is (800) 253-1301. Dial just as you normally dial long distance — the call is free.

23. Check that you have all of your tools.

24. Turn on the water faucets and check for leaks. Tighten the couplings if there is leaking.

25. Replace the access panel. Be sure to tighten screws at each end of the access panel. Replace the bumper under the center screw and tighten the center screw.

26. Read the Use and Care Guide to fully understand your new washer/dryer. Wipe out the drum. Plug the electrical cord into a grounded outlet. Now start the washer and allow it to complete the regular cycle.

27. Open the dryer door. Check to be sure the lint screen is in its proper position. Start the dryer and allow it to complete a cycle to make sure it is working properly.

28. Finally, save all literature and keep it with the washer/dryer.



Alternate electrical connection

⚠ WARNING

Electrical Shock Hazard

- Electrical ground is required on this appliance.
 - Improper connection of the equipment-grounding conductor line can result in electrical shock.
 - Check with a qualified electrician if you are in doubt as to whether the appliance is properly grounded.
 - Do Not modify the power supply cord plug. If it will not fit the outlet, have a proper outlet installed by a qualified electrician. Modifying the power supply cord plug could result in electrical shock.
 - Use a new 30-ampere power supply cord kit. Do Not reuse an old power supply cord. Possible electrical shock or fire hazard could occur if old power supply cord is used.
 - Disconnect the power supply cord from the electric supply before making these changes. Failure to do so may result in personal injury.
- Failure to follow these instructions could result in electrical shock.

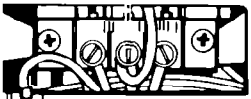

This appliance is manufactured with a 30 amp rated, four-wire, flexible type power supply cord with the green grounding wire connected to the grounding connector.

When local codes...

Do Not Permit the use of the flexible four-wire power supply cord that comes equipped with the washer/dryer and

Permit four-wire copper power supply cable and

Permit connecting cabinet-grounding conductor to the neutral wire of the power supply cable:

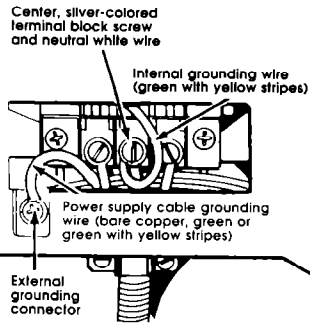

Four-wire ungrounded neutral

Figure 4

1. Disconnect the power supply.
2. Remove the power cord equipped with the washer/dryer as instructed. See "To remove power supply cord," Panel F.
3. Install copper four-wire power supply cable through the 3/4", U.L.-listed strain relief. (See "Electrical Requirements", Panels A and B)
4. Connect the grounding wire (bare copper, green or green with yellow stripes) of the copper, four-wire power supply cable to the external grounding connector.
5. Connect the neutral wire (white) of the power supply cable and internal grounding wire (green with yellow stripes) to the center, silver-colored, terminal screw of the terminal block. Connect the other wires to the outer terminals. Tighten each screw firmly. See Figure 4. For plain-end wires, see "Direct wiring connection," Panel G.
6. Replace the terminal block cover.

To convert to a three-wire electrical system.

When local codes...

A.

Permit use of a flexible-type power supply cord (pigtail) plugged into a matching, 30-amp receptacle (See "Electrical requirements", Panels A and B) and

Permit connection of the internal grounding conductor to the neutral wire of the power supply cord:

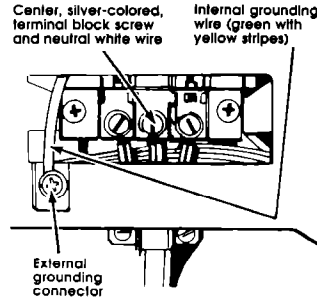

Grounded neutral

Figure 5

1. Disconnect the power supply.
2. Remove the power supply cord equipped with the washer/dryer as instructed. See Panel F, "To remove the power supply cord".
3. Install a three-wire power supply cord (See "Electrical requirements", Panel A and B) through the 3/4", U.L.-listed strain relief.
4. Move the internal grounding wire (green with yellow stripes) from the center, silver-colored terminal block screw to the external grounding connector.
5. Connect the neutral wire (white) of the power supply cord to the center, silver-colored, terminal screw of the terminal block. Connect the other wires to the outer terminals. Tighten each screw firmly. See Figure 5. For plain-end wires, see "Direct wiring connection," Panel G.
6. Replace the terminal block cover.

To connect a separate grounding wire —

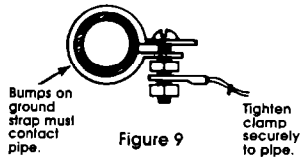

Use grounding wire and clamp assembly (Part No. 685463) or No.-10 gauge minimum, copper, grounding wire.

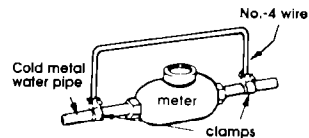

Figure 10

Connect grounding wire to a grounded, cold water pipe* with the clamp and then to the grounding connector on the washer/dryer. **Do Not ground to a gas supply pipe or hot water pipe.** Do Not connect the power supply cord to electric power supply until the appliance is permanently grounded.

*Grounded, cold water pipe must have metal continuity to electrical ground and not be interrupted by plastic, rubber or other electrical insulating connectors such as hoses, fittings, washer or gaskets (including water meter or pump). Any electrical insulating connector should be jumped as shown with a length of No.-4 wire securely clamped to bare metal at both ends.

To remove the power supply cord —

1. Disconnect the power supply.
2. Remove the terminal block cover from the dryer.
3. Disconnect the power supply cord from the terminal block.
4. Disconnect the green, grounding wire of the power supply cord from the external grounding connector.
5. Loosen the strain relief screws.
6. Pull downward on the power supply cord until it is removed from the dryer. (See Figure 11.)

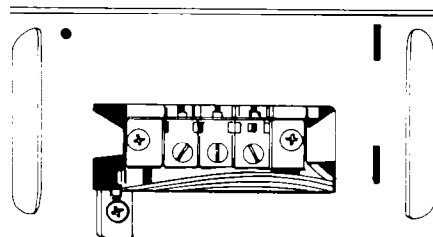

Figure 11

When local codes...

B.

Permit the use of a flexible-type power supply cord (pigtail) but

Do Not permit connecting cabinet-grounding conductor to the neutral wire of the power supply cord:

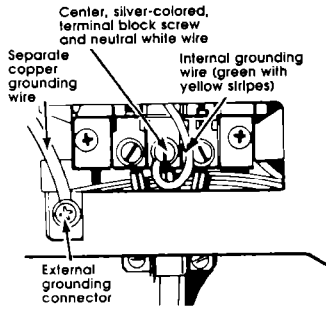

Ungrounded neutral

Figure 6

Connect separate, copper grounding wire (No. 10 minimum) from external grounding connector to approved ground.

1. Disconnect the power supply.
2. Remove the power supply cord equipped with the washer/dryer as instructed. See Panel F, "To remove the power supply cord."
3. Install a three-wire power supply cord (See "Electrical Requirements", Panels A and B) through the 3/4", U.L.-listed strain relief.
4. Connect the neutral wire (white) of the power supply cord and the internal grounding wire (green with yellow stripes) to the center, silver-colored, terminal screw of the terminal block. Connect the other wires to the outer terminals. Tighten screws firmly. (See Figure 6.) For plain-end wires, see "To connect connection," Panel G.
5. Connect a separate copper grounding wire (No. 10 minimum). See "To connect a separate grounding wire," Panel F for detailed instructions.
6. Replace the terminal block cover.

When local codes...

C.

Do Not permit the use of a flexible, three-wire, power supply cord and Permit three-wire, copper power supply cable and Permit connecting the cabinet-grounding conductor to the neutral wire of the power supply cable:

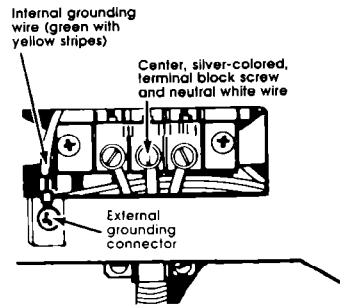

Grounded neutral

Figure 7

1. Disconnect the power supply cord.
2. Remove the power supply cord equipped with the washer/dryer as instructed. See "To remove the power supply cord", Panel F.
3. Install copper power supply cable (See "Electrical requirements", Panels A and B) through the 3/4", U.L.-listed strain relief.
4. Move the internal grounding wire (green with yellow stripes) from the center, silver-colored, terminal block screw to the external grounding connector.
5. Connect the neutral wire (white) of the flexible, armored or non-metallic sheathed, copper, power supply cable to the center, silver-colored, terminal screw of the terminal block. Connect the other wires to the outer terminals. Tighten the screws firmly. See Figure 7. For plain-end wires, see "To connect connection," Panel G.
6. Replace the terminal block cover.

When local codes...

D.

Do Not permit the use of three-wire, flexible, power supply cord and Permit three-wire, copper power supply cable but

Do Not permit connecting the cabinet-grounding conductor to the neutral wire of the power supply cable:

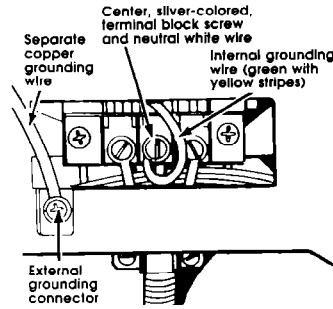

Ungrounded neutral

Figure 8

Connect separate, copper grounding wire (No. 10 minimum) from external grounding connector to approved ground.

1. Disconnect the power supply.
2. Remove the power supply cord equipped with the washer/dryer as instructed. See "To remove the power supply cord", Panel F.
3. Install copper power supply cable (See "Electrical requirements", Panels A and B) through the 3/4", U.L.-listed strain relief.
4. Connect the neutral wire (white) of the flexible, armored or non-metallic sheathed, copper, power supply cable and the internal grounding wire (green with yellow stripes) to the center, silver-colored, terminal screw of the terminal block. Connect the other wires to the outer terminals. Tighten screws firmly. (See Figure 8.) For plain-end wires, see "Direct wiring connection," Panel G.
5. Connect a separate, copper, grounding wire (No. 10 minimum). See "To connect a separate grounding wire", Panel F, for detailed instructions.
6. Replace the terminal block cover.

Direct wiring connection

1. Disconnect the power supply.
2. Strip the outer covering back 3 inches from the end exposing the three wires.

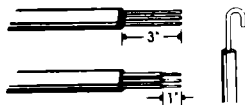

Plain-end wiring
Figure 12

3. Strip the insulation back 1 inch from the end of each wire. Form the bare wires into a "U"-shaped hook.
4. Loosen, Do Not remove, screws from terminal block. Attach wires according to instructions for type of connection needed.
5. Slide the end of each wire under the screw head with the open side of the screw hook on the right. Squeeze the wire together to form a loop.
6. Tighten each screw firmly.
7. Tighten strain relief screws.

Recessed and closet installation instructions

⚠ WARNING

Fire Hazard

- The dryer should be exhausted outside. Failure to do so increases the risk of fire.
- If washer/dryer is installed in a closet, the dryer MUST be exhausted outside. Failure to do so may cause a fire.

This washer/dryer may be installed in a recessed area or closet.

The installation spacing is in inches and is minimum allowable. Additional spacing should be considered for ease of installation, servicing and compliance with local codes and ordinances.

If closet door is installed, the minimum unobstructed air openings in top and bottom is required. Louvered doors with equivalent air openings are acceptable. Closet installation must be exhausted.

Other installations must use the minimum dimensions indicated.

To prevent large amounts of lint and moisture from accumulating and to maintain drying efficiency, this appliance should be exhausted outdoors.

Recessed nonexhausted installation must use only the rear exhaust position and Exhaust Deflector, Part No. 694609.

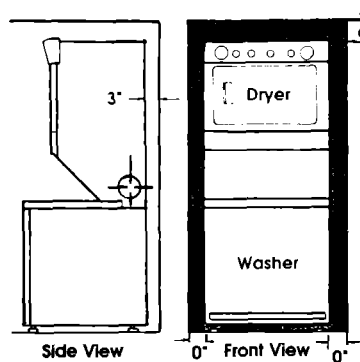

Recessed area minimum installation spacing.

Note: If recessed installation is exhausted to the side or rear, 6 inches must be available above the washer/dryer but all other spacing can be 0 inches.

Closet installation must be exhausted outdoors.

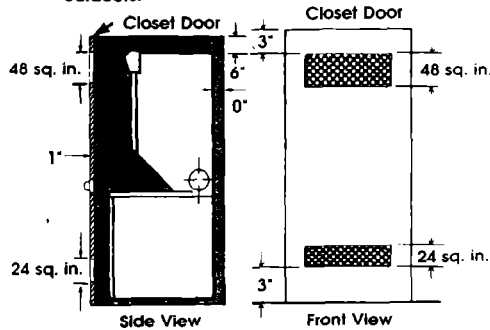

Product dimensions

