

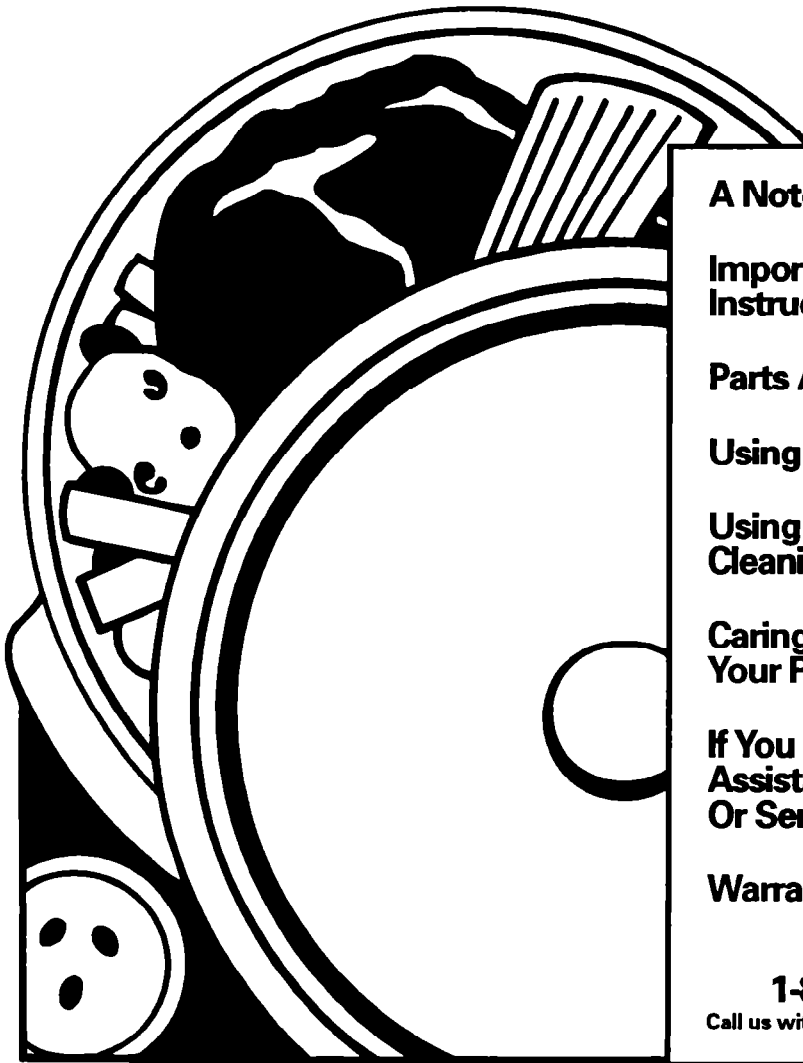

# Use And Care

## GUIDE



A Note To You	2
Important Safety Instructions	3
Parts And Features	6
Using Your Range	7
Using the Self-Cleaning Cycle	28
Caring For Your Range	32
If You Need Assistance Or Service	37
Warranty	40

**1-800-253-1301**

Call us with questions or comments.

### SELF-CLEANING GAS RANGE

**TO THE INSTALLER: PLEASE LEAVE THIS INSTRUCTION BOOK WITH THE UNIT.**

**MODEL SF385PEY**

**TO THE CONSUMER: PLEASE READ AND KEEP THIS BOOK FOR FUTURE REFERENCE.**

## A NOTE TO YOU

# A Note To You

### Thank you for buying a Whirlpool appliance.

You have purchased a quality, *world-class* home appliance. Years of engineering experience have gone into its manufacturing. To ensure that you will enjoy many years of trouble-free operation, we have developed this Use and Care Guide. It is full of valuable information on how to operate and maintain your appliance properly and safely. Please read it carefully. Also, please complete and mail the Ownership Registration Card provided with your appliance. This will help us notify you about any new information on your appliance.

### Your safety is important to us.

This guide contains safety symbols and statements. Please pay special attention to these symbols and follow any instructions given. Here is a brief explanation of the use of each symbol.

#### **⚠ WARNING**

This symbol will help alert you to such dangers as personal injury, burns, fire and electrical shock.

#### **⚠ CAUTION**

This symbol will help you avoid actions which could cause product damage (scratches, dents, etc.) and damage to your personal property.



For more information, see the "The anti-tip bracket" on page 27.

### Our Consumer Assistance Center number, 1-800-253-1301, is toll-free, 24 hours a day.

If you ever have a question concerning your appliance's operation, or if you need service, first see "If You Need Assistance Or Service" on page 37. If you need further help, feel free to call our Consumer Assistance Center. When calling, you will need to know your appliance's complete model number and serial number. You can find this information on the model and serial number plate (see diagram on page 6). For your convenience, we have included a handy place below for you to record these numbers, the purchase date from the sales slip and your dealer's name and telephone number. Keep this book and the sales slip together in a safe place for future reference.

Model Number \_\_\_\_\_

Dealer Name \_\_\_\_\_

Serial Number \_\_\_\_\_

Dealer Phone \_\_\_\_\_

Purchase Date \_\_\_\_\_

# Important Safety Instructions

Gas ranges have been thoroughly tested for safe and efficient operation. However, as with any appliance, there are specific installation and safety precautions which must be followed to ensure safe and satisfactory operation.

## **⚠ WARNING**

To reduce the risk of fire, electrical shock, injury to persons, or damage when using the range, follow basic precautions, including the following:

**WARNING: If the information in this manual is not followed exactly, a fire or explosion may result causing property damage, personal injury or death.**

**Do not store or use gasoline or other flammable vapors and liquids in the vicinity of this or any other appliance.**

### **WHAT TO DO IF YOU SMELL GAS:**

- Do not try to light any appliance.
- Do not touch any electrical switch; do not use any phone in your building.
- Immediately call your gas supplier from a neighbor's phone. Follow the gas supplier's instructions.
- If you cannot reach your gas supplier, call the fire department.

**Installation and service must be performed by a qualified installer, service agency or the gas supplier.**

### **General**

- Install or locate the range only in accordance with the provided Installation Instructions. The range must be installed by a qualified installer. The range must be properly connected to the proper gas supply and checked for leaks. The range must also be properly connected to electrical supply and grounded.
- Gas fuels and their use in appliances can cause minor exposures to benzene, formaldehyde, carbon monoxide and soot, primarily from incomplete combustion. Significant exposure to these substances can cause cancer or reproductive harm. Properly adjusted burners with a blue, rather than a yellow, flame will minimize incomplete combustion. Venting with a hood or an open window will further minimize exposure.

continued on next page

## IMPORTANT SAFETY INSTRUCTIONS

- Do not store things children might want above the range. Children could be burned or injured while climbing on it.
- Do not leave children alone or unattended in area where the range is in use. They should never be allowed to sit or stand on any part of the range. They could be burned or injured.
- Do not operate the range if it is damaged or not working properly.
- Do not use the range for warming or heating the room. Persons could be burned or injured, or a fire could start.
- Do not attempt to light the oven burner during a power failure. Personal injury could result. Reset oven controls to the off position in the event of a power failure.
- Use the range only for its intended use as described in this manual.
- Use only dry potholders. Moist or damp potholders on surface burners may result in burns from steam. Do not let potholder touch surface burners. Do not use a towel or bulky cloth for a potholder. It could catch on fire.
- Keep range vents unobstructed.
- Do not heat unopened containers. They could explode. The hot contents could cause burns and container particles could cause injury.
- Do not store flammable materials on or near the range. The fumes can create an explosion and/or fire hazard.
- Do not use the oven for storage.
- Never use a match or other flame to look for a gas leak. Explosion and injury could result.
- Know where your main gas shutoff valve is located.



- **DO NOT TOUCH SURFACE BURNERS, AREAS NEAR SURFACE BURNERS OR INTERIOR SURFACES OF OVEN.** Areas near surface burners and interior surfaces of an oven become hot enough to cause burns. During and after use, do not touch, or let clothing or other flammable materials contact surface burners, areas near surface burners or interior surfaces of oven until they have had sufficient time to cool. Other surfaces of the range may become hot enough to cause burns; such as, the oven vent opening, the surface near the vent opening, the cooktop, the oven door and window.



- Do not wear loose or hanging garments when using the range. They could ignite if they touch a hot surface burner and you could be burned.

### **When using the cooktop**

- Make sure the utensils you use are large enough to contain food and avoid boilovers and spillovers. Heavy splattering or spillovers left on a range can ignite and burn you. Pan size is especially important in deep fat frying.
- Check to be sure glass cooking utensils are safe for use on the range. Only certain types of glass, glass-ceramic, ceramic, earthenware or other glazed utensils are suitable for cooktops without breaking due to the sudden change in temperature.
- Never leave surface burners unattended at high heat settings. A boilover could result and cause smoking and greasy spillovers that may ignite.



- Turn pan handles inward, but not over other surface burners. This will help reduce the chance of burns, igniting of flammable materials, and spills due to bumping of the pan.
- Do not use decorative covers or trivets over the surface burners.

## IMPORTANT SAFETY INSTRUCTIONS

### When using the oven

- Always position the oven rack(s) in desired location while oven is cool.
- Use care when opening oven door. Let hot air or steam escape before removing or replacing food.

### Grease

- Grease is flammable. Do not allow grease to collect around cooktop or in vents. Wipe spills immediately.



- Do not use water on grease fires. Never pick up a flaming pan. Smother flaming pan by covering with a well-fitted lid, cookie sheet or flat tray. Flaming grease outside of pan can be extinguished with baking soda or, if available, a multipurpose dry chemical or foam-type extinguisher.

### Care and cleaning

- Small amounts of formaldehyde and carbon monoxide are given off in the Self-Cleaning cycle from fiberglass insulation and food decomposition. Significant exposure to these substances can cause cancer or reproductive harm. Exposure can be minimized by venting with a hood or open window and wiping out excess food spills prior to self-cleaning.



- Do not use oven cleaners. No commercial oven cleaner or oven liner protective coating of any kind should be used in or around any part of the oven.
- Before self-cleaning the oven, remove broiler pan, broiler grid, oven racks and other utensils. Do not use your oven to clean miscellaneous parts unless you are instructed to do so in this Use and Care Guide.
- Do not clean door heat seal. It is essential for a good seal. Care should be taken not to rub, damage or move the seal. Clean only parts recommended in this Use and Care Guide.
- Do not repair or replace any part of the range unless specifically recommended in this manual. All other servicing should be referred to a qualified technician.
- Disconnect the electrical supply and the gas supply at the shutoff valve near the range before servicing the range.

**- SAVE THESE INSTRUCTIONS -**

## PARTS AND FEATURES

# Parts And Features

This section contains captioned illustrations of your range. Use them to become familiar with the location and appearance of all parts and features.

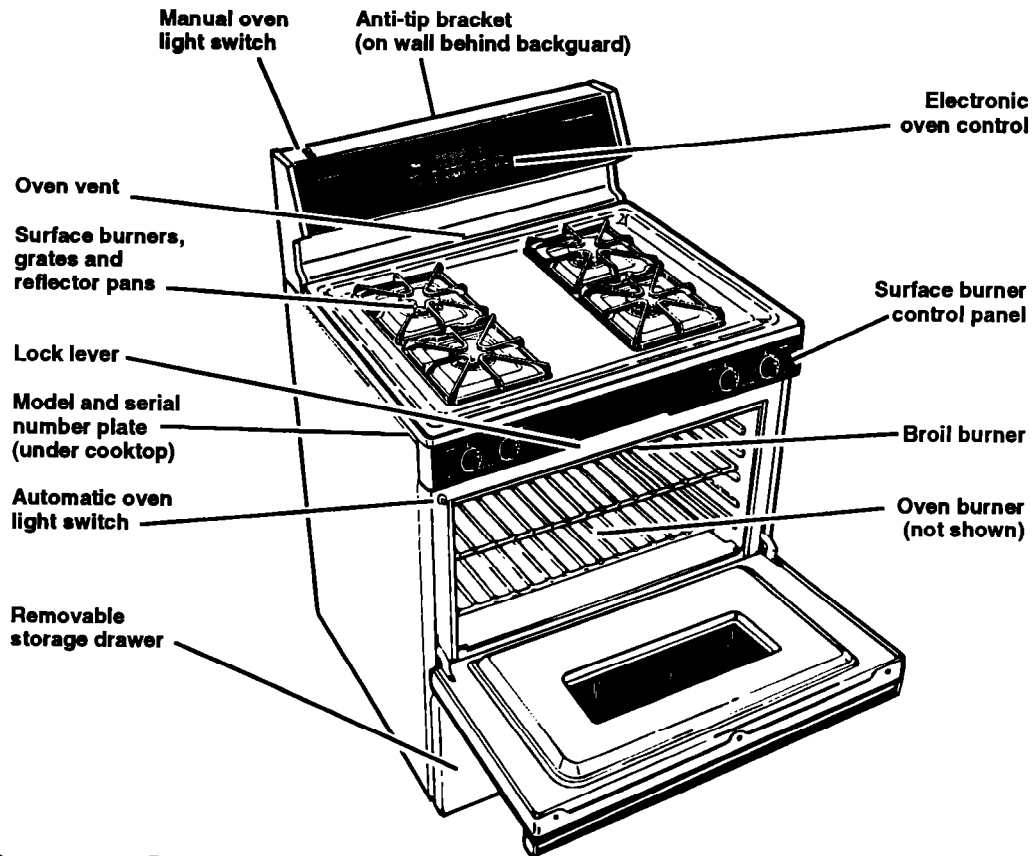

## Control panels



# Using Your Range

In This Section		Page	Page
Using the surface burners .....	7	Adjusting the oven temperature control .....	15
Positioning racks and pans .....	9	Broiling .....	16
For best air circulation .....	10	Broiling tips .....	17
The electronic oven control .....	11	Energy saving tips .....	17
Setting the clock .....	12	Using the electronic MEALTIMER™ control .....	18
Using the electronic Minute Timer .....	12	The oven vent .....	27
Using the Off/Cancel pad .....	13	The storage drawer .....	27
Audible signals .....	13	The anti-tip bracket .....	27
Baking/roasting .....	14		

To obtain the best cooking results possible, you must operate your range properly. This section gives you important information for efficient and safe use of your range.

## Using the surface burners

Your range is equipped with electric ignitors. Electric ignitors automatically light the burners each time they are used.

**Push in control knobs and turn them to the LITE position.** The clicking sound is the ignitor sparking. **Visually check that burner has lit.**

**To stop the clicking sound after the burner lights, turn the control knob to the desired setting.** The control knob has stops for HI, MED and LOW. However, you can set the control knob anywhere between HI and OFF.

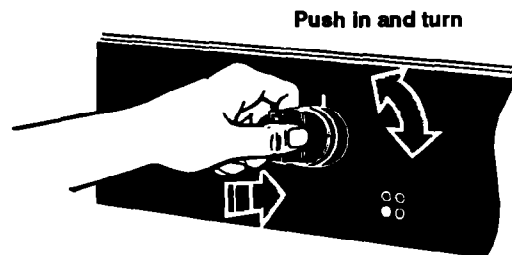

### Surface burner markers

The solid dot in the surface burner marker shows which surface burner is turned on by that knob.

### Burner heat settings

**Use correct burner heat settings (see next page).** If the heat setting is too high, it can:

- **Char** bacon and cause curling.
- **Make** eggs tough and crisp at the edges.
- **Toughen** liver, fish and seafood.
- **Scorch** delicate sauces and custards.
- **Cause** a boilover.

## USING YOUR RANGE

Until you get used to the settings, use the following as a guide. For best results, start cooking at the high setting; then turn the control knob down to continue cooking.

SETTING	RECOMMENDED USE
LITE	<ul style="list-style-type: none"> <li>To light the burner. After the burner lights, turn control back to a desired setting to stop the clicking of the ignitor.</li> </ul>
HI	<ul style="list-style-type: none"> <li>To start foods cooking.</li> <li>To bring liquids to a boil.</li> </ul>
MED	<ul style="list-style-type: none"> <li>To hold a rapid boil.</li> <li>To fry chicken or pancakes.</li> <li>For gravy, pudding and icing.</li> <li>To cook large amounts of vegetables.</li> </ul>
LOW	<ul style="list-style-type: none"> <li>To keep food warm until ready to serve.</li> </ul>

**NOTE:** Do not cook with the control in the LITE position.

### In case of a prolonged power failure

Surface burners can be manually lighted. Hold a lit match near a burner and turn the control knob to the LITE position. After the burner lights, turn the control knob to the desired setting.

### ⚠ WARNING

#### Burn, Fire, Explosion and Product Damage Hazard

- Burner flame should not extend beyond the edge of the cooking utensil. The flame can burn you and cause poor cooking results.
- Be sure all control knobs are turned to OFF when you are not cooking. Someone could be burned or a fire could start if a burner is accidentally left ON.
- If the flame should go out while cooking, or if there is a strong gas odor, turn the burners OFF. Wait five minutes for the gas odor to disappear before relighting burner. If gas odor is still present, see safety note on page 3. Failure to follow these precautions could result in explosion or fire.
- Do not leave an empty utensil, or one which has boiled dry, on a hot surface burner. The utensil can overheat and may damage the utensil or cooking product.

### Cookware tips

There is no one brand of cooking utensil that is best for all people. Knowing something about pan materials and construction will help you select the cooking utensils for your needs.

- **NOTE: For best results and greater fuel efficiency, use only flat-bottomed utensils that make good contact with the surface burners.** Utensils with rounded, warped, ridged (porcelain enamel-ware) or dented bottoms could cause severe overheating, which damages the utensil and/or surface burner.

Woks, canners and teakettles with flat bottoms suitable for use on your cooktop are now available in most stores that sell housewares.

- **The pan** should have straight sides and a tight-fitting lid.
- **Choose medium to heavy gauge** (thickness) pans that are fairly lightweight.
- **The pan material** (metal or glass) affects how fast heat transfers from the surface burner through the pan material and how evenly heat spreads over the pan bottom. Choose pans that provide the best cooking results.
- **Handles** should be made of a sturdy, heat-resistant material and be securely attached to the pan.
- **Pans** should be easy to clean. Check to be sure there are no crevices, rough edges or areas where food might collect.
- **Be sure pans** do not tip, whether they are full or empty.
- **Use utensils** only as they were intended to be used. Follow pan instructions. This is very important for glass cookware because some should be used only in the oven. Other pans are marked as flameware and may be used on the surface burners.

### Home canning information

The large diameter of most water-bath or pressure canners combined with high heat settings for long periods of time can cause damage to the cooktop.

#### To protect your range:

- **For best results, use** a canner which can be centered over the surface burner.
- **Do not place canner** on two surface burners at the same time. Too much heat will build up and will damage the cooktop.
- **Start with hot water.** This reduces the time the control is set on high. Reduce heat setting to lowest position needed to keep water boiling.



## Positioning racks and pans

For baking/roasting with one rack, place the rack so the top of the food will be centered in the oven.

Rack placement for specific foods:

FOOD	RACK POSITION
Frozen pies, large roasts, turkeys	1st or 2nd rack guide from bottom
Angel and bundt cakes, most quick breads, yeast breads, casseroles, meats	2nd rack guide from bottom
Cookies, biscuits, muffins, cakes, nonfrozen pies	2nd or 3rd rack guide from bottom

When baking on two racks, arrange racks on first and third rack guides from bottom.

**NOTE:** For recommended rack placement when broiling, see "Broiling rack position chart" on page 17.

### 6th oven rack position (roasting rack)

When roasting food too large to be placed in oven with rack in lowest position, place rack on bottom of oven.

For proper roasting, follow these guidelines:

- The rack must be level.
- Use adequate amount of liquid (meat juices or water) so food does not get overdone.
- Do not try to pull rack out over door. Rack will be at the same level as door when door is opened.

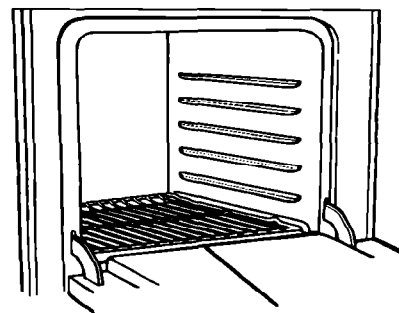

6th oven rack position

### **⚠ WARNING**

#### Personal Injury Hazard

- Always position oven rack(s) in desired location before turning oven on. Be sure the rack(s) is level.
- If rack(s) must be moved while oven is hot, use potholders or oven mitts to protect hands.
- Do not place items on the open oven door.
- Be careful when installing and removing large food items from sixth rack position. Food will be close to hot surfaces, including oven bottom and sides.

Failure to follow the above precautions may result in personal injury.

### For best air circulation

Hot air must circulate around the pans in the oven for even heat to reach all parts of the oven. This results in better baking.

- **Place** the pans so that one is not directly over the other.
- **For best results, allow** 1½-2 inches (4-5 cm) of space around each pan and between pans and oven walls. There must be a minimum space of 1 inch (2.5 cm).
- **Use** only one cookie sheet in the oven at one time.

Use the following as a guide to determine where to place the pans.

#### **One pan**

Place in the center of the oven rack.

#### **Two pans**

Place in opposite corners of the oven rack.

#### **Three or four pans**

Place in opposite corners on each oven rack. Stagger pans so no pan is directly over another.

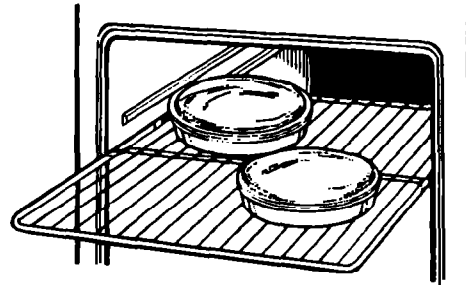

## The electronic oven control

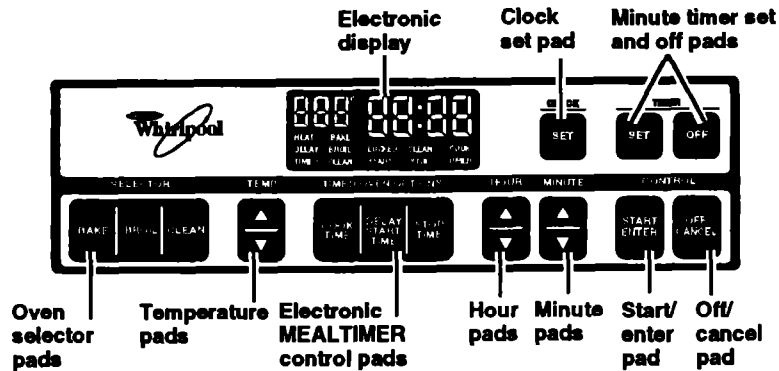

### Display/clock

- **When you first plug in the range**, a time of day and "PF" will show in the temperature display. If after you set the clock (page 12) the display again shows "PF", your electricity was off for a while. Reset the clock.
- **When you are not using the oven**, this is an accurate clock.
- **When using the oven or Minute Timer**, the display will show the time, temperature settings and what command buttons have been pushed.
- **When showing the time of day**, the display will show the hour and minutes.
- **When using the Minute Timer**, the display will show minutes and seconds in the following sequence:
  - For settings from 1-59 minutes, the display will count down each second.
  - For settings over 1 hour, the display will count down each minute.
- **When using Cook Time and/or Stop Time**, the display will show hours and minutes.

### Command pads

The command pads tell the oven what to do and in what order. A few examples:

- **Clock/Set** tells the oven you are going to set the clock.
- **Off/Cancel** tells the oven to turn off.

Each command pad (except Off/Cancel and Start/Enter) has its own indicator. The indicator comes on when you push the command pad.

## USING YOUR RANGE

### Setting the clock

1. **Push** the Clock/Set pad. The colon flashes and TIME will light up in the display.

CLOCK

SET



2. **Use** the Hour and Minute pads to set the time of day. **Push** the “up” (▲) or “down” (▼) pad(s) until the correct time shows in the display.

HOUR MINUTE

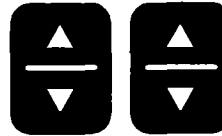

3. **Push** the Start/Enter pad.

**NOTE:** If you do not want the clock time displayed, push and hold the Clock/Set pad for 4 seconds. To display the clock time again, push the Clock/Set pad once, then reset the clock time if necessary.

START  
ENTER

START  
ENTER

### Using the electronic Minute Timer

The Minute Timer does not start or stop the oven. It works like a kitchen timer. You can set it in hours and minutes up to 11 hours, 59 minutes. The Minute Timer will display minutes and seconds for settings under one hour. You will hear four 1-second tones when the set time is up.

1. **Push** the Timer Set pad. TIMER will come on and the display will show “0:00” with the colon flashing.

TIMER

SET

OFF



2. **Use** the Hour and Minute pads to set the desired time. **Push** the “up” (▲) or “down” (▼) pad(s) until the correct time shows in the display.

HOUR MINUTE



## USING YOUR RANGE

3. **Push** the Start/Enter pad. The Minute Timer will begin counting down immediately after the timer is started.

When time is up, "End" will show in the large display and you will hear four 2-second tones. You will also hear four 1-second tones every minute until you push one of the two Timer pads.

**NOTE:** To disable the reminder tones, push and hold the Timer Set pad for 4 seconds. To reactivate the tones, follow the same procedure.



### To cancel the Minute Timer:

- **Push** the Timer Off pad. The time of day will show in the display.

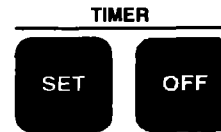

---

## Using the Off/Cancel pad

The Off/Cancel pad will cancel any command pad except for the Clock/Set and Timer Set pads. When you push the Off/Cancel pad, the display will show the time of day or, if Minute Timer is also being used, the time remaining.



---

## Audible signals

Audible signals tell you if a function is entered correctly or not. They also tell you when a cycle is completed.

**To shut off all signals except for the end-of-timer tone:**

1. **Press** and **hold** the Stop Time pad for 4 seconds.
2. A short tone will sound to tell you the signals have been changed.

**Repeat** the above steps to turn the signals back on.

## Baking/roasting

1. **Position** the rack(s) properly before turning on the oven. **To change rack position, lift** rack at front and **pull out**. For further information, see "Positioning racks and pans" on page 9.
2. **Push** the Bake pad. "350°" will show in the small display to indicate the preset temperature and BAKE will light up.

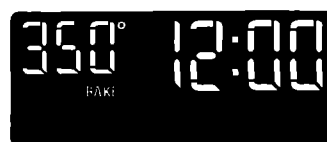

3. **To cook at a different temperature, use** the Temp pad(s). **Push ▲** to raise the temperature or ▼ to lower the temperature in 5°F increments. **Use** these pads until the desired temperature shows in the small display.



4. **Push** the Start/Enter pad. "Lo°", HEAT and BAKE show in the display to indicate that the oven is preheating. The temperature will increase in 5° increments.



**NOTE:** The display will show "door" and a tone will sound once a minute for 5 minutes if the door is latched when you try to bake/roast.

You can change the temperature setting any time after pushing the Start/Enter pad by pushing just the Temp pad(s).



5. **When baking, preheat** the oven. (Preheating is not needed when roasting.) The oven is preheated when you hear a one-second tone and HEAT goes off.

6. **Put** food in the oven.

During baking/roasting, the oven burner will turn on and off to keep the oven temperature at the setting.

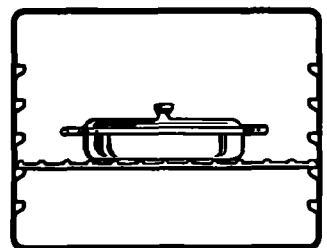

7. **When baking/roasting is done, push** the Off/Cancel pad. The time of day will show in the display and all other displays will go off.



## **Adjusting the oven temperature control**

Oven temperature controls will gradually shift after years of use. So, even though your new oven is properly adjusted to provide accurate temperatures, it may cook faster or slower than your old oven.

If, after using the oven for a period of time, you are not satisfied with the temperature settings, you can adjust them by following these steps:

1. **Push the Bake pad and hold** (for about 4 seconds) until the time display shows the current temperature offset, for example "00" if you have not previously adjusted the temperature.
2. **To adjust the temperature, use the Temp pad(s).** Push ▲ to raise the temperature or ▼ to lower the temperature in 5°F increments. You can set the temperature change to as low as -35°F or as high as +35°F. A minus (-) sign will appear before the number when decreasing the temperature setting to show the oven will be cooler by the displayed amount.



3. **After making the desired adjustment, push any command pad to enter the new offset temperature.**

## Broiling

1. **Position** the rack before turning the oven on.  
See "Broiling rack position chart" on page 17.
2. **Preheat** the broiler for 5 minutes before using.
3. **Push** the Broil pad. The small display will show "HI". The time of day and BROIL will light up.



4. **Push** the Start/Enter pad. HEAT, BROIL and "HI" show in the display. The broiler will automatically light in 50-60 seconds.

**NOTE:** The display will show "door" and a tone will sound once a minute for 5 minutes if the door is latched when you try to broil.

You can change the temperature setting any time after pushing the Start/Enter pad by pushing just the Temp pad(s).

5. **After preheating, put** the broiler pan and food on the rack.
6. **Completely close** the oven door to ensure proper broiling temperatures.
7. **When broiling is done, push** the Off/Cancel pad. The time of day will show in the display and all other displays will go off.

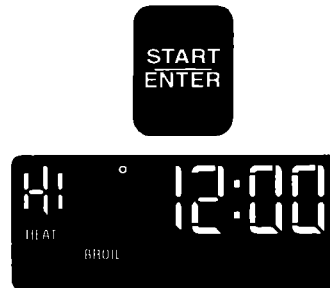

### To broil at a lower temperature:

- **If food is cooking too fast**, push the Broil pad and push the ▼ Temp pad until "Lo" shows in the small display.
- **If you want food to broil slower from the start**, push the Broil pad and push the ▼ Temp pad so a "Lo" setting shows in the small display. This burner setting allows the broil burner to cycle and provides slow cooking. BROIL and HEAT will light up in the display.
- **Fish and chicken** are some foods that may cook better if you use lower broiling temperatures.

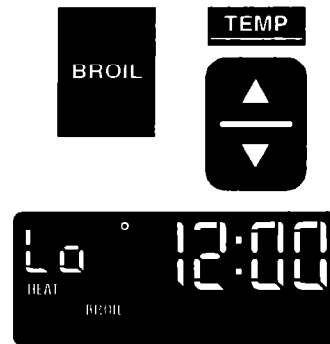



## Broiling tips

- **Use** the broiler pan and grid for broiling. They are designed to drain excess liquid and fat away from the cooking surface to help prevent spatter, smoke or fire.
- **If you broil small quantities**, you may want to use a small broiler pan. They are available in the housewares section of many department stores.
- **For best broiling results**, preheat at HI° for 5 minutes. Do not preheat with broiler pan in place.
- **Broiling rack position** determines how the burner cooks your food. The lower the position, the more broiler grid area covered. See "Broiling rack position chart" below for more information.
- **To sear meat**, place broiler pan at one of the higher rack positions so that meat is very near the flame.
- **Small steaks** may be broiled in the higher rack positions.
- **To cook large steaks** and other thick cuts of meat well done, move them to a lower rack position after searing.
- **Refer** to a broiling chart in a reliable cookbook for correct broiling times.
- **After broiling**, remove the broiler pan from the oven when you remove the food. Drippings will bake on the pan if you leave it in the heated oven.

### **⚠ WARNING**

#### **Fire Hazard**

- Place meat the correct distance from the burner. Meat placed too close to the burner may spatter, smoke, burn or catch fire during broiling.
- To ensure adequate grease drainage, do not use cookie sheets or similar pans for broiling. Also, covering the broiler grid with foil is not recommended. Poor drainage of grease may result in fire.

### Broiling rack position chart

RACK POSITION FROM BOTTOM	FOOD
4	Rare steaks and fish
3	Medium and well-done steaks and hamburgers; well-done foods such as chicken, lobster, ham slices and pork chops

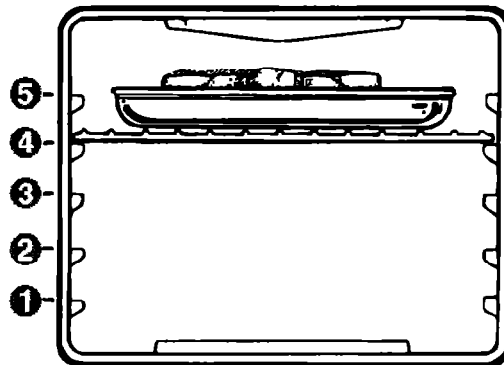

## Energy saving tips

Although the energy used for cooking is usually a very small percentage of the total energy used in the home, cooking energy can be used efficiently. Here are some tips to help you save energy when using your cooking product.

- **Use** pans with flat bottoms, straight sides and tight-fitting lids.
- **Cook** with a minimum of liquid or fat to help shorten cooking time.
- **Preheat** pans only when recommended and for the shortest time possible.
- **Start** food on higher heat settings, then set surface unit control on low or off to finish cooking. Use retained heat for cooking when possible.
- **Use** the more efficient surface burners instead of the oven when possible.
- **Turn on** the surface burner only after placing filled pan on the burner grate.
- **"Oven peeking"** may cause heat loss, longer cooking times and unsatisfactory baking results. Rely on your timer to keep track of the cooking time.
- **Bake** cakes, pies or cookies when oven is warm. Best time is after a meal has been cooked in it.
- **Preheat** the oven no longer than necessary.
- **Plan** your meals for the most efficient use of the range. When using the oven to cook one food, try to cook the rest of the meal in it also.
- **Do not preheat** when roasting or cooking items such as casseroles.

### Using the electronic MEALTIMER™ control

The electronic MEALTIMER™ control will turn the oven on and off at times you set ... even when you are not around.

Delayed time baking/roasting is ideal for foods which do not require a preheated oven, such as meats and casseroles. **Do not use the delayed time cycle for cakes, cookies, etc. ... undercooking will result.**

This section discusses two methods of starting baking/roasting now and stopping automatically later, and three methods of starting and stopping baking/roasting automatically. Read this section carefully to choose the best method(s) for you.

**Before using the electronic MEALTIMER control, make sure the clock is set to the correct time of day.** (See "Setting the clock" on page 12.)

#### To start baking/roasting now and stop automatically

##### Method 1—Using Cook Time:

1. **Position** the oven rack(s) properly and put food in the oven.
2. **Push** the Bake pad to enter the Bake mode. **Use** the Temp pad(s) to set the desired temperature. **Push** ▲ to raise the temperature or ▼ to lower the temperature in 5°F increments. **Use** these pads until the desired temperature shows in the small display.

After you have set the desired temperature, the display will show the set temperature and the time of day. **BAKE** will light up.

3. **Push** the Cook Time pad. "0:00" with the colon flashing and **COOK TIME** will show in the display.

A small rectangular indicator light with the word "BAKE" written in white capital letters on a dark background.A small rectangular indicator light with the words "COOK TIME" written in white capital letters on a dark background.

## USING YOUR RANGE

4. Use the Hour and Minute pads to set the desired cooking time. Push the “up” (▲) or “down” (▼) pad(s) until the correct time shows in the display.

This example shows a desired baking/roasting time of 30 minutes.

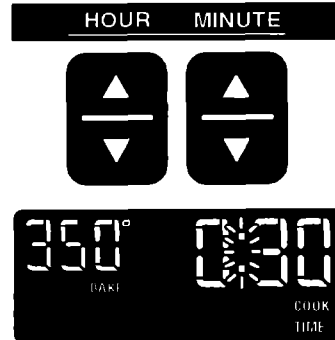

5. Push the Start/Enter pad. “Lo°”, HEAT, BAKE, TIMED and the set cook time will show in the display to indicate that the oven is heating.

**NOTE:** The display will show “door” and a tone will sound once a minute for 5 minutes if the door is latched when you try to bake/roast.

You can change the temperature or time settings any time after pushing the Start/Enter pad by repeating just Steps 2 through 4.

6. The display will count down the baking/roasting time in minutes.

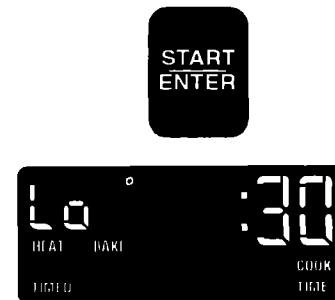

7. When the baking/roasting time is completed, the oven will turn off automatically, beep four times and “End” will show in the display. You will also hear four 1-second tones every minute until you push the Off/Cancel pad.

**NOTE:** To disable reminder tones, push and hold the Cook Time pad for 4 seconds. To reactivate tones, repeat this procedure.



To cancel the MEALTIMER™ control setting:

- Push the Off/Cancel pad to return the display to the time of day.



### Method 2—Using Stop Time:

1. Position the oven rack(s) properly and put food in the oven.
2. Push the Bake pad to enter the Bake mode. Use the Temp pad(s) to set the desired temperature. Push ▲ to raise the temperature or ▼ to lower the temperature in 5°F increments. Use these pads until the desired temperature shows in the small display.



## USING YOUR RANGE

After you have set the desired temperature, the display will show the set temperature and the time of day. BAKE will light up.

3. Push the Stop Time pad. The time of day with the colon flashing and STOP TIME will show in the display.
4. Use the Hour and Minute pads to set the desired stop time. Push the “up” (▲) or “down” (▼) pad(s) until the correct time shows in the display.

This example shows a desired stop time of 2 o'clock. This provides a 2-hour cook time (the difference between the time of day and the stop time).

5. Push the Start/Enter pad. “Lo”, HEAT, TIMED and BAKE will light up in the display to indicate that the oven is heating.  
**NOTE:** The display will show “door” and a tone will sound once a minute for 5 minutes if the door is latched when you try to bake/roast.  
You can change the temperature or time settings any time after pushing the Start/Enter pad by repeating just Steps 2 through 4.
6. The display will count down the baking/roasting time in minutes.
7. When the baking/roasting time is completed, the oven will turn off automatically, beep four times and “End” will show in the display. You will also hear four 1-second tones every minute until you push the Off/Cancel pad.  
**NOTE:** To disable reminder tones, push and hold the Cook Time pad for 4 seconds. To reactivate tones, repeat this procedure.

To cancel the MEALTIMER™ control setting:

- Push the Off/Cancel pad to return the display to the time of day.

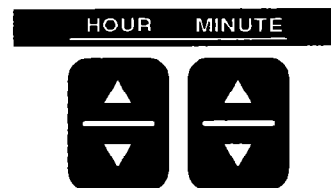

## USING YOUR RANGE

### To delay start and stop automatically

#### Method 1—Using Cook Time and Delay Start Time:

1. **Position** the oven rack(s) properly and put food in the oven.
2. **Push** the Bake pad to enter the Bake mode. **Use** the Temp pad(s) to set the desired temperature. **Push** ▲ to raise the temperature or ▼ to lower the temperature in 5°F increments. **Use** these pads until the desired temperature shows in the small display.

After you have set the desired temperature, the display will show the set temperature and the time of day. BAKE will light up.



3. **Push** the Cook Time pad. "0:00" with the colon flashing and COOK TIME will show in the display.



4. **Use** the Hour and Minute pads to set the desired cooking time. **Push** the "up" (▲) or "down" (▼) pad(s) until the correct time shows in the display.

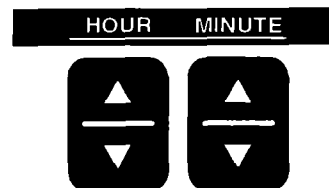

This example shows a desired baking/roasting time of 30 minutes.



5. **Push** the Delay Start Time pad. The time of day with the colon flashing will show in the display and START TIME will light up.



## USING YOUR RANGE

6. Use the Hour and Minute pads to set the desired start time. Push the “up” (▲) or “down” (▼) pad(s) until the correct time shows in the display.

This example shows a desired start time of 2 o'clock. The oven will automatically shut off at 2:30 (the set start time plus the set cook time).

7. Push the Start/Enter pad. DELAY and BAKE will light up in the display to indicate that the oven is programmed to start at a later time.  
**NOTE:** The display will show “door” and a tone will sound once a minute for 5 minutes if the door is latched when you try to bake/roast.  
 You can change the temperature or time settings any time after pushing the Start/Enter pad by repeating just Steps 2 through 6.

8. When the start time is reached, a one-second tone will sound and DELAY will go off. The display will show the set cook time. “Lo”, HEAT, TIMED and BAKE will light up in the display to show that the oven is heating. The display will count down the baking/roasting time in minutes.
9. When the baking/roasting time is completed, the oven will turn off automatically, beep four times and “End” will show in the display. You will also hear four 1-second tones every minute until you push the Off/Cancel pad.  
**NOTE:** To disable reminder tones, push and hold the Cook Time pad for 4 seconds. To reactivate tones, repeat this procedure.

To cancel the MEALTIMER™ control setting:

- Push the Off/Cancel pad to return the display to the time of day.

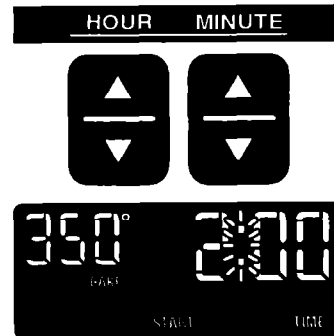

## USING YOUR RANGE

### Method 2—Using Delay Start Time and Stop Time:

1. **Position** the oven rack(s) properly and **put** food in the oven.
2. **Push** the Bake pad to enter the Bake mode. **Use** the Temp pad(s) to set the desired temperature. **Push** ▲ to raise the temperature or ▼ to lower the temperature in 5°F increments. **Use** these pads until the desired temperature shows in the small display.

After you have set the desired temperature, the display will show the set temperature and the time of day. BAKE will light up.

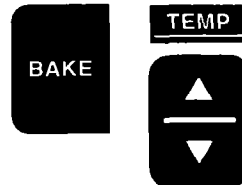

3. **Push** the Delay Start Time pad. The time of day with the colon flashing will show in the display and START TIME will light up.
4. **Use** the Hour and Minute pads to set the desired start time. **Push** the “up” (▲) or “down” (▼) pad(s) until the correct time shows in the display.

This example shows a desired start time of 2 o'clock.

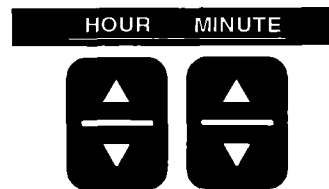

5. **Push** the Stop Time pad. The time of day with the colon flashing will show in the display and STOP TIME will light up.



## USING YOUR RANGE

- Use the Hour and Minute pads to set the desired stop time. Push the “up” (▲) or “down” (▼) pad(s) until the correct time shows in the display.

This example shows a desired stop time of 2:30. This provides a cook time of 30 minutes (the difference between the start and stop times).

**NOTE:** If you do not set a stop time, the colon will flash in the display and STOP and COOK will flash alternately to remind you to program a stop time or a cook time. (See page 21 for instructions on how to set delay start and stop automatically using Cook Time and Delay Start Time.)

- Push the Start/Enter pad. DELAY and BAKE will light up in the display to indicate that the oven is programmed to start at a later time.

**NOTE:** The display will show “door” and a tone will sound once a minute for 5 minutes if the door is latched when you try to bake/roast.

You can change the temperature or time settings any time after pushing the Start/Enter pad by repeating just Steps 2 through 6.

- When the start time is reached, a one-second tone will sound and DELAY will go off. The display will show the set cook time. “Lo”, HEAT, TIMED and BAKE will light up in the display to show that the oven is heating. The display will count down the baking/roasting time in minutes.

- When the baking/roasting time is completed, the oven will turn off automatically, beep four times and “End” will show in the display. You will also hear four 1-second tones every minute until you push the Off/Cancel pad.

**NOTE:** To disable reminder tones, push and hold the Cook Time pad for 4 seconds. To reactivate tones, repeat this procedure.

To cancel the MEALTIMER™ control setting:

- Push the Off/Cancel pad to return the display to the time of day.

### Method 3—Using Cook Time and Stop Time:

- Position the oven rack(s) properly and put food in the oven.

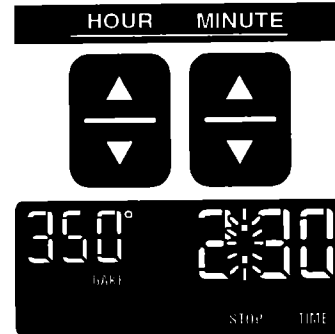

**BEEP BEEP BEEP BEEP**





## USING YOUR RANGE

2. Push the Bake pad to enter the Bake mode. Use the Temp pad(s) to set the desired temperature. Push ▲ to raise the temperature or ▼ to lower the temperature in 5°F increments. Use these pads until the desired temperature shows in the small display.

After you have set the desired temperature, the display will show the set temperature and the time of day. BAKE will light up.

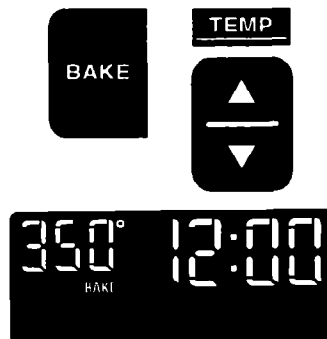

3. Push the Cook Time pad. "0:00" with the colon flashing and COOK TIME will show in the display.

4. Use the Hour and Minute pads to set the desired cooking time. Push the "up" (▲) or "down" (▼) pad(s) until the correct time shows in the display.

This example shows a desired baking/roasting time of 30 minutes.

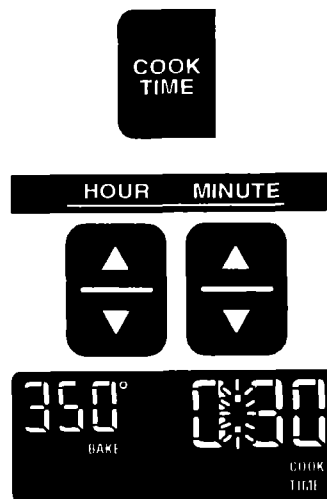

5. Push the Stop Time pad. The time of day with the colon flashing will show in the display and STOP TIME will light up.

6. Use the Hour and Minute pads to set the desired stop time. Push the "up" (▲) or "down" (▼) pad(s) until the correct time shows in the display.

This example shows a desired stop time of 2:30. The oven will automatically start cooking at 2:00 (the set stop time minus the set cook time).

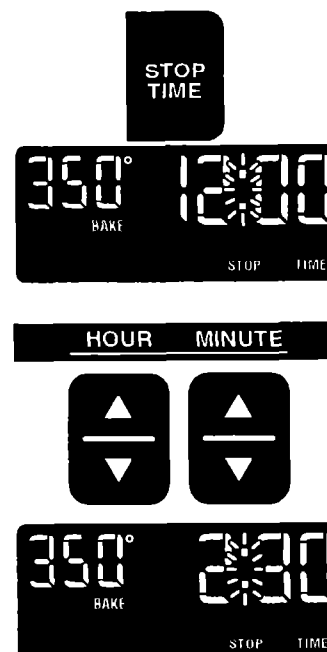

## USING YOUR RANGE

7. Push the Start/Enter pad. DELAY and BAKE will light up in the display to indicate that the oven is programmed to start at a later time.
- NOTE:** The display will show "door" and a tone will sound once a minute for 5 minutes if the door is latched when you try to bake/roast. You can change the temperature or time settings any time after pushing the Start/Enter pad by repeating just Steps 2 through 6.

8. When the start time is reached, a one-second tone will sound and DELAY will go off. The display will show the set cook time. "Lo", HEAT, TIMED and BAKE will light up in the display to show that the oven is heating. The display will count down the baking/roasting time in minutes.

9. When the baking/roasting time is completed, the oven will turn off automatically, beep four times and "End" will show in the display. You will also hear four 1-second tones every minute until you push the Off/Cancel pad.

**NOTE:** To disable reminder tones, push and hold the Cook Time pad for 4 seconds. To reactivate tones, repeat this procedure.

To cancel the MEALTIMER™ control setting:

- Push the Off/Cancel pad to return the display to the time of day.

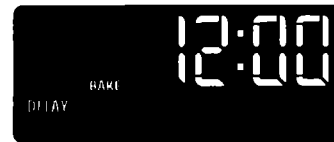

BEEP BEEP BEEP BEEP



### ⚠ WARNING

To avoid sickness and food waste when using the MEALTIMER™ control:

- Do not let most UNFROZEN food stand for more than two hours before cooking starts.
- Do not allow food to remain in oven for more than two hours after the end of cooking cycle.

**NOTE:** Do not use foods that will spoil while waiting for cooking to start. Such foods are: dishes with milk or eggs, cream soups and cooked meats or fish. Also, foods containing baking powder or yeast will not rise properly when cooked using delay start.

## The oven vent

Hot air and moisture escape from the oven through a vent located in lower part of backguard. The vent is needed for air circulation. **Do not block the vent.** Poor baking/roasting will result.

**NOTE:** Never store plastics, paper or other items that could melt or burn near the oven vent, or any of the surface burners.

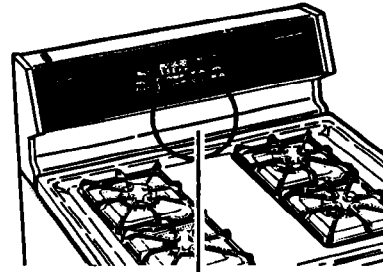

Oven vent

### **⚠ WARNING**

#### **Burn Hazard**

When the oven is ON, pans and pan handles left near the oven vent can become hot enough to burn the user and to melt plastics. Use potholders to move pans.

## The storage drawer

You can remove the storage drawer to make it easier to clean under the range. **Use care when handling the drawer.**

#### Removing the storage drawer:

1. Empty drawer before removing. Pull drawer straight out to the first stop. Lift front and pull out to the second stop.
2. Lift back slightly and slide drawer all the way out.

#### Replacing the storage drawer:

1. Fit ends of drawer slide rails into the drawer guides on both sides of opening.
2. Lift drawer front and push in until metal stops on drawer slide rails clear white stops on drawer guides. Lift drawer front again to clear second stop and slide drawer closed.

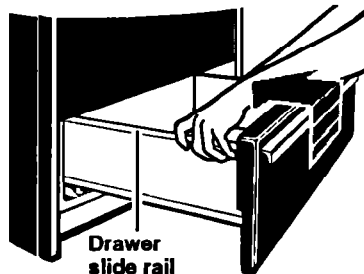
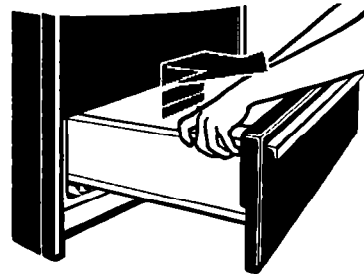

Drawer slide rail

## The anti-tip bracket

The range will not tip during normal use. However, tipping can occur if you apply too much force or weight to the open door without the anti-tip bracket properly secured.

#### To verify the anti-tip bracket is engaged:

- Look to see if the anti-tip bracket is attached with screws to the wall behind the backguard.
- Make sure the cable tether on the back of the range is secured by the two hooks on the bracket.
- See Installation Instructions for further details.

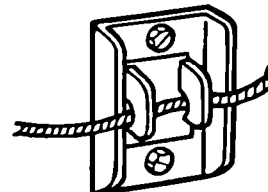

# Using The Self-Cleaning Cycle

In This Section		Page	Page
How the cycle works .....	28	Setting the controls .....	29
Before you start .....	28	Special tips .....	32

The Self-Cleaning cycle saves you from the toil and mess that often come with hand-cleaning the oven interior. Like with the other functions of your range, you operate the Self-Cleaning cycle with the easy-to-use control. Please review the instructions in this section to keep your oven spotless.

## How the cycle works

The Self-Cleaning cycle uses very high heat to burn away soil and grease. During the cycle, the oven gets much hotter than it does for normal baking or broiling. This high heat breaks up the soil or grease and burns it away.

We recommend a 3-hour Self-Cleaning cycle. However, you can adjust the cycle time to the amount of soil in your oven. You can set the cycle anywhere between 2 and 4 hours. (See "Setting the controls" on page 29.)

The graph at the right is representative of a normal, 3-hour Self-Cleaning cycle. Note that the heating stops when the 3-hour setting is up, but it takes longer for the oven to cool enough to unlock.

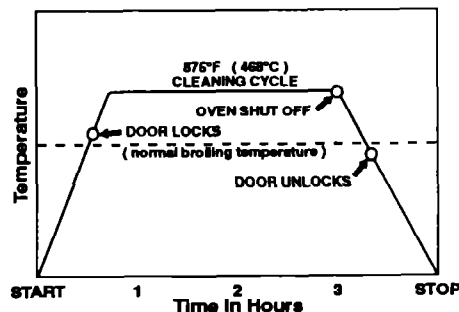

## Before you start

Before you start the Self-Cleaning cycle, make sure you:

- **Hand-clean the areas shown.** They do not get hot enough during the cleaning cycle for soil to burn away. Use hot water and detergent or a soapy steel-wool pad for cleaning.

**NOTE:** DO NOT clean, move or bend the seal. Poor cleaning, baking and roasting may result.

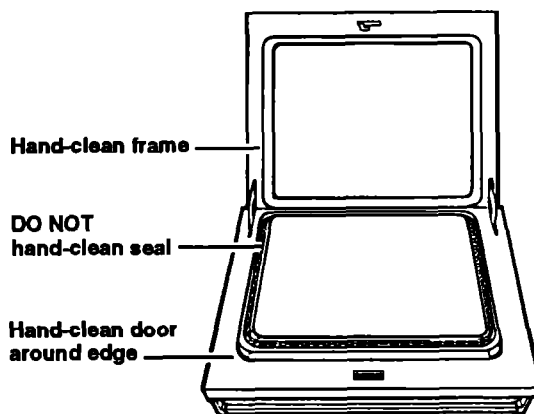

## USING THE SELF-CLEANING CYCLE

- **Remove any pots and pans** being stored in the oven.  
**NOTE:** You can clean the broiler pan and grid in the oven if you have first removed most of the soil by hand-cleaning or a dishwasher. If most of the soil is not removed, too much smoking will occur.
- **Wipe out any loose soil or grease.** This will help reduce smoke during the cleaning cycle.
- **Remove the oven racks from the oven if you want them to remain shiny.** You can clean the oven racks in the Self-Cleaning cycle, but they will become harder to slide. (See page 35.) If you clean racks in the Self-Cleaning cycle, place them on the 2nd and 4th rack guides. (Guides are counted from bottom to top.)
- **Heat and odors are normal** during the Self-Cleaning cycle. Keep the kitchen well ventilated by opening a window or by turning on a vent hood or other kitchen vent during the cycle.

### ⚠ WARNING

#### Personal Injury and Product Damage Hazard

- Do not touch the oven during the Self-Cleaning cycle. It could burn you.
- Do not use commercial oven cleaners in your oven. Cleaners may produce hazardous fumes or damage the porcelain finish.
- Do not leave foil in the oven during the Self-Cleaning cycle. Foil can burn or melt and damage the oven surface.

**NOTE:** Do not force the Lock Lever. You could bend or break it. The lever is designed to stay locked until the oven is cool enough to safely open. Wait until it moves freely.

Do not block the vent during the Self-Cleaning cycle. Air must move freely for best cleaning results.

Do not leave plastic utensils near the vent. They may melt.

## Setting the controls

1. **Make sure** the clock is set to the correct time of day. (See "Setting the clock" on page 12.)
2. **Move** the Lock Lever all the way to the right—the Clean position.

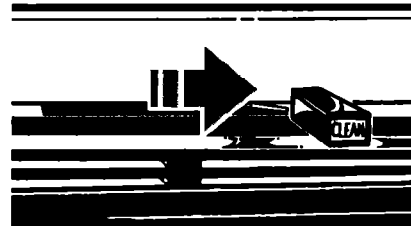

3. **Set cleaning cycle.**

**To start cleaning immediately:**

**Push** the Clean pad. A 3-hour Self-Cleaning cycle will be set automatically. "3:00" with the colon flashing will show in the large display and "cln" will show in the small display. TIME, CLEAN (on right side) and CLEAN (on left side) will light up.



## USING THE SELF-CLEANING CYCLE

If a cleaning cycle other than 3 hours is desired, use the Hour and Minute pads to set the desired cleaning time. Push the “up” (▲) or “down” (▼) pad(s) until a time between 2-4 hours shows in the display.

- Use 2 hours for light soil.
- Use 3-4 hours for moderate to heavy soil.

Push the Start/Enter pad. TIMED and HEAT will light up in the display to indicate that the oven is programmed for the Self-Cleaning cycle.

**NOTE:** The display will show “door” and a tone will sound once a minute for 5 minutes if the door is not latched.

Skip to Step 4.

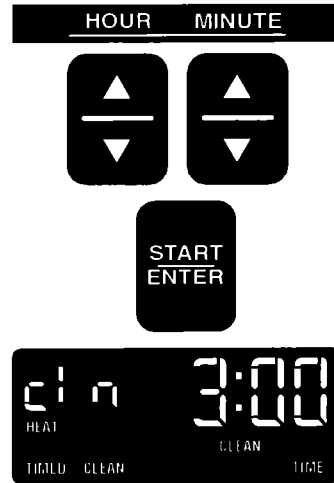

### To delay the start using Stop Time:

Push the Clean pad. Push the Stop Time pad. STOP, TIME, CLEAN and “cln” will light up.

Use the Hour and Minute pads to set the desired stop time. Push the “up” (▲) or “down” (▼) pad(s) until the correct time shows in the display. The oven will automatically compute the delay start time by subtracting the set cleaning time from the set stop time.

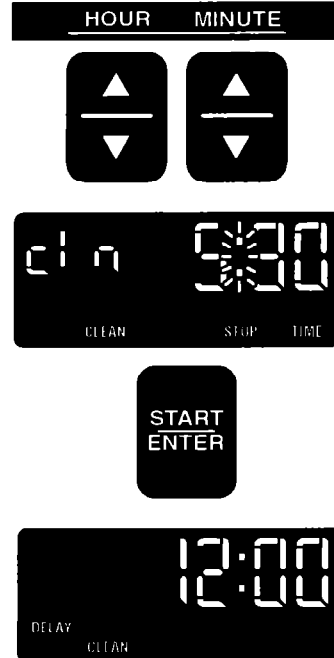

Push the Start/Enter pad. DELAY, CLEAN and the time of day will light up in the display to indicate that the oven is programmed to start the Self-Cleaning cycle at a later time. Skip to Step 4.

# USING THE SELF-CLEANING CYCLE

**To delay the start using Delay Start Time:**  
Push the Clean pad. Push the Delay Start Time pad. START, TIME, CLEAN and "cln" will light up.

Use the Hour and Minute pads to set the desired start time. Push the "up" (▲) or "down" (▼) pad(s) until the correct time shows in the display.

Push the Start/Enter pad. DELAY, CLEAN and the time of day will light up in the display to indicate that the oven is programmed to start the Self-Cleaning cycle at a later time. After the start time has been set, the large display will go back to showing the current time of day. DELAY and CLEAN will stay on. When the start time is reached, DELAY will go off, TIMED, HEAT, CLEAN and CLEAN TIME will light up and the oven will start to clean.

- 4. After the Self-Cleaning cycle is started, LOCKED lights up in the display when the oven temperature goes above normal baking/roasting temperatures. The Lock Lever must not be moved and the door cannot be opened when LOCKED is on.
- 5. After the Self-Cleaning cycle is completed, the time of day will show in the display.
- 6. When the oven reaches normal baking/roasting temperatures, LOCKED goes off and "End" and CLEAN TIME come on. Move the Lock Lever back to the left. DO NOT FORCE IT. Wait until it moves easily.

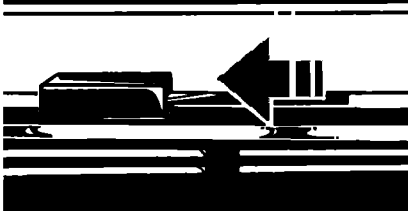

# CARING FOR YOUR RANGE

## To stop the Self-Cleaning cycle at any time:

1. Push the Off/Cancel pad.
2. When LOCKED goes off, move the Lock Lever back to the left. **DO NOT FORCE IT.** Wait until it moves easily.



## Special tips

- Keep the kitchen well ventilated during the Self-Cleaning cycle to help get rid of heat, odors and smoke.
- After the oven is cool, wipe up any residue or ash with a damp cloth or sponge. If any spots remain, clean with a mild abrasive cleanser or mildly abrasive pad.
- Clean the oven before it gets heavily soiled. Cleaning a very soiled oven takes longer and results in more smoke than usual.
- If the Self-Cleaning cycle does not get the oven as clean as you expected, the cycle may not have been set long enough or you may not have prepared the oven properly. Set the Self-Cleaning cycle longer the next time and hand-clean areas noted on page 28.

# Caring For Your Range

In This Section		Page	Page
Surface burner grates and reflector pans .....	33	Cleaning chart .....	34
Lift-up cooktop .....	33	The oven light .....	36
Surface burners .....	34		

Your range is designed for ease of care. You can do most cleaning with items found around your home. Cleaning your range whenever spills or soiling occurs will help to keep it looking and operating like new.

**⚠ WARNING**

**Burn, Electrical Shock,  
Fire and Explosion Hazard**

- Make sure all controls are OFF and the range is cool before cleaning.
- Do not use oven cleaners, bleach or rust removers.
- Do not obstruct the flow of combustion and ventilation air.

Failure to follow these guidelines could result in burns, electrical shock, fire or explosion.



## Surface burner grates and reflector pans

1. **Make sure** all surface burners are off and the surrounding parts are cool.
2. **Lift off** the surface burner grates and remove the reflector pans.
3. **Wash** the grates and reflector pans with warm, soapy water or in a dishwasher. Use a nonabrasive, plastic scrubbing pad for cooked-on foods. **Rinse** and **dry well**.
4. **Replace** reflector pans and burner grates.

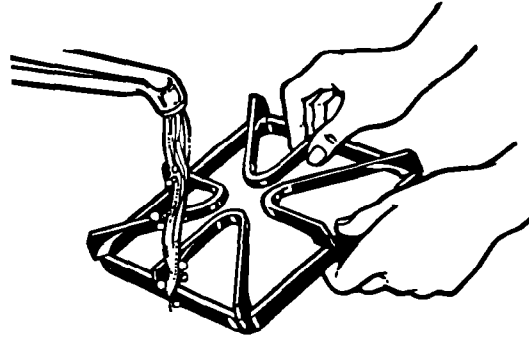

## Lift-up cooktop

1. **Remove** surface burner grates and reflector pans.
2. **Lift front** of cooktop at both front corners until the support rods lock into place.

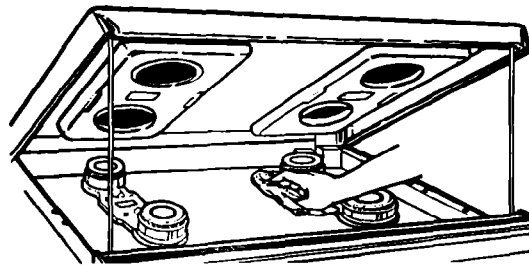

### **⚠ WARNING**

#### **Personal Injury and Product Damage Hazard**

- Be sure both support rods are fully extended and in the locked position. Failure to do so could result in personal injury from the cooktop accidentally falling.
- Do not drop the cooktop. Damage can result to the porcelain and the cooktop frame.

3. **Wipe** with warm, soapy water. Use a soapy steel-wool pad on heavily soiled areas.
4. **To lower the cooktop**, lift cooktop from both sides while pressing the support rods back to unlock them. **Lower** the cooktop into place. **Replace** reflector pans and surface burner grates.

## Surface burners

1. **Lift up** the cooktop, following the instructions on page 33.
2. **Before cleaning, remove** screws that hold each of the burners in place. The screws prevent the burners from moving during shipment. **Remove** the shipping screws with a Phillips screwdriver and lift the burners up and out. This separates the burners from the mounting bracket under each burner pair.
3. **Wipe off** surface burners with warm, soapy water and a sponge after each use. **To remove cooked-on food, soak** the burners in a vinegar and water solution for 20-30 minutes. **Scrub** with a plastic scrubbing pad.
4. If ports are clogged, clean with a straight pin. **DO NOT enlarge or distort the ports. DO NOT use a toothpick to clean the ports.**
5. **Before putting the burners back, dry** them thoroughly by setting them in a warm oven for 30 minutes.
6. **Replace** burners, making sure they are properly seated and level. **Replace** screws.
7. **Occasionally check** the burner flames for proper size and shape as shown. A good flame is blue in color. If flames lift off ports, are yellow, or are noisy when turned off, you may need to clean the burners (see above), or call a qualified technician for adjustment.

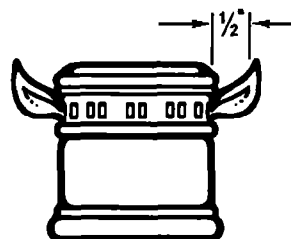
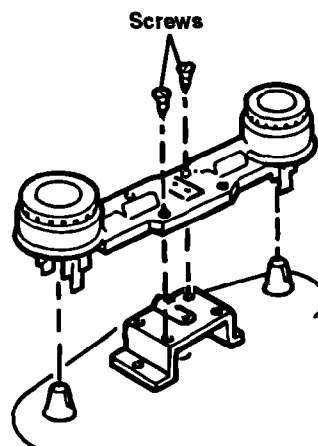

Typical surface burner flame at highest setting

## Cleaning chart

Use the following table to help you clean your range.

PART	WHAT TO USE	HOW TO CLEAN
Control knobs	Sponge and warm, soapy water	<ul style="list-style-type: none"> <li>• Turn knobs to OFF and pull straight away from control panel.</li> <li>• Wash, rinse and dry thoroughly. Do not soak.</li> <li>• Replace knobs. Make sure all knobs point to OFF.</li> </ul> <p>DO NOT USE steel wool or abrasive cleaners. They may damage the finish of the knobs.</p>
Control panels	Sponge and warm, soapy water OR Paper towel and spray glass cleaner	<ul style="list-style-type: none"> <li>• Wash, rinse and dry thoroughly.</li> </ul> <p>DO NOT USE steel wool or abrasive cleaners. They may damage the finish. DO NOT SPRAY cleaner directly on panel. Apply cleaner to paper towel.</p> <p><b>NOTE:</b> Make sure you have not turned the oven on when cleaning panel. If you have, push the Off/Cancel pad.</p>

## CARING FOR YOUR RANGE

PART	WHAT TO USE	HOW TO CLEAN
<b>Exterior surfaces</b> (other than control panels)	Sponge and warm, soapy water	<ul style="list-style-type: none"> <li>• Wash, rinse and dry thoroughly. USE nonabrasive, plastic scrubbing pad on heavily soiled areas.</li> <li>• Do not use abrasive or harsh cleansers. They may damage the finish.</li> </ul> <p><b>NOTE:</b> Do not allow foods containing acids (such as vinegar, tomato or lemon juice) to remain on surface. Acids may remove the glossy finish. Also wipe up milk or egg spills when cooktop is cool.</p>
<b>Surface burner grates and reflector pans</b>	Warm, soapy water and a nonabrasive, plastic scrubbing pad <b>OR</b> Dishwasher	<ul style="list-style-type: none"> <li>• In dishwasher, wash with other cooking utensils.</li> <li>• Dry completely.</li> <li>• <b>Do not use abrasive or harsh cleansers.</b></li> </ul>
<b>Surface burners</b>	Sponge and warm, soapy water  Warm, soapy water and a nonabrasive, plastic scrubbing pad <b>OR</b> Vinegar and water solution	<ul style="list-style-type: none"> <li>• Lift up the cooktop. (See page 33.)</li> <li>• Wipe off spills immediately after burner has cooled.</li> </ul> <p><b>For cooked-on food:</b></p> <ul style="list-style-type: none"> <li>• Remove burner from manifold with Phillips screwdriver.</li> <li>• Wash with warm, soapy water and a plastic scrubbing pad or soak in vinegar and water solution.</li> <li>• Rinse and dry well.</li> <li>• If ports are clogged, clean with a straight pin. <b>Do not enlarge or distort ports. Do not use a wooden toothpick.</b></li> <li>• Do not clean surface burner in dishwasher.</li> </ul>
<b>Broiler pan and grid</b> (clean after each use)	Steel-wool pad and warm, soapy water	<ul style="list-style-type: none"> <li>• Wash, rinse and dry thoroughly.</li> </ul>
<b>Oven racks</b>	Steel-wool pad and warm, soapy water <b>OR</b> The Self-Cleaning cycle	<ul style="list-style-type: none"> <li>• Wash, rinse and dry thoroughly.</li> </ul> <p><b>OR</b></p> <ul style="list-style-type: none"> <li>• Leave in oven during Self-Cleaning cycle.</li> </ul> <p><b>NOTE:</b> Racks will permanently discolor and become harder to slide if left in oven during Self-Cleaning cycle. Apply a small amount of vegetable oil to the side rungs to aid sliding.</p>
<b>Oven door glass</b>	Paper towel and spray glass cleaner <b>OR</b> Warm, soapy water and a nonabrasive, plastic scrubbing pad	<ul style="list-style-type: none"> <li>• Make sure oven is cool.</li> <li>• Follow directions provided with the cleaner.</li> <li>• Wash, rinse and dry thoroughly.</li> </ul>
<b>Oven cavity</b>	Self-Cleaning cycle	<ul style="list-style-type: none"> <li>• See "Using The Self-Cleaning Cycle" on pages 28-32.</li> </ul>

## The oven light

The oven light will come on when you open the oven door. **To turn the light on when the oven door is closed, use the Oven Light Switch on the control panel.**

### **⚠ WARNING**

#### **Electrical Shock and Personal Injury Hazard**

- Make sure oven and light bulb are cool and power to the range has been turned OFF before replacing the light bulb. Failure to do so could result in electrical shock or burns.
- The bulb cover must be in place when using the oven. The cover protects the bulb from breaking, and from high oven temperatures. Because bulb cover is made of glass, be careful not to drop it. Broken glass could cause injury.

#### **To replace the oven light:**

1. **Unplug** appliance or **disconnect** at the main electric power supply.
2. **Remove** the glass bulb cover in the back of the oven by pushing the wire holder to the side and pulling out bulb cover.
3. **Remove** the light bulb from its socket. **Replace** the bulb with a 40-watt appliance bulb.

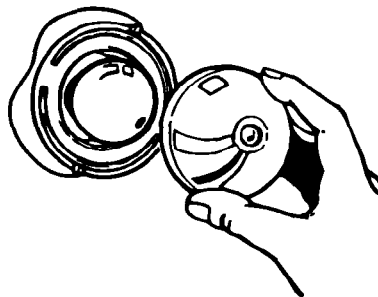

4. **Replace** the bulb cover and **snap** the wire holder into place. **Plug in** appliance or **reconnect** at the main power supply.

**NOTE:** The oven light should not be used during the Self-Cleaning cycle. Use during the Self-Cleaning cycle will shorten the life of the bulb.

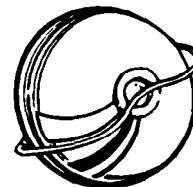

# If You Need Assistance Or Service

This section is designed to help you save the cost of a service call. Part 1 of this section outlines possible problems, their causes, and actions you can take to solve each problem. Parts 2 and 3 tell you what to do if you still need assistance or service. When calling our Consumer Assistance Center for help or calling for service, please provide a detailed description of the problem, your appliance's complete model and serial numbers and the purchase date. (See page 2.) This information will help us respond properly to your request.

## 1. Before calling for assistance ...

Performance problems often result from little things you can find and fix without tools of any kind. Please check the chart below for problems you can fix. It could save you the cost of a service call.

PROBLEM	POSSIBLE CAUSE	SOLUTION
Nothing will operate	The power cord is not plugged into a live circuit with proper voltage. Range is not properly connected to gas supply. A household fuse has blown or a circuit breaker has tripped. Controls are not set correctly. The flow of combustion and/or ventilation air to the range is blocked.	Plug the power cord into a live circuit with proper voltage. (See Installation Instructions.) Contact an authorized Whirlpool <sup>SM</sup> service technician to reconnect range to gas supply. (See Installation Instructions.) Replace household fuse or reset circuit breaker. Reset controls, if needed. Remove blockage to airflow to and around range.
The oven will not operate	The electronic control has not been set correctly. A delayed start time has been programmed.	Refer to pages 14-26 for setting the electronic control. Wait for the start time to be reached.
Burner fails to light	The power cord is not plugged into a live circuit with proper voltage. A household fuse has blown or a circuit breaker has tripped. Burner ports are clogged.	Plug the power cord into a live circuit with proper voltage. (See Installation Instructions.) Replace household fuse or reset circuit breaker. In case of prolonged power failure, manually light burners (see page 8). Clean with a straight pin (see page 34).
Burner flames are uneven	Burner ports are clogged.	Clean with a straight pin (see page 34). If this fails, call an authorized Whirlpool <sup>SM</sup> service technician for service.
Burner flames lift off ports, are yellow, or are noisy when turned off		Contact an authorized Whirlpool <sup>SM</sup> service technician to check air/gas mixture.
Burner makes popping noise when on	Burner is wet from washing.	Let dry.

continued on next page

## IF YOU NEED ASSISTANCE OR SERVICE

PROBLEM	POSSIBLE CAUSE	SOLUTION
<b>Control knob(s) will not turn</b>	You are not pushing in before turning.	Push control knob(s) in before turning to a setting.
<b>Self-Cleaning cycle will not operate</b>	The range clock does not show the correct time of day. The Lock Lever is not in the Clean position-all the way to the right. A delayed start time has been programmed.	Reset clock to show the correct time of day. (See page 12.) Move Lock Lever all the way to the right.  Wait for the start time to be reached.
<b>Cooking results are not what you expected</b>	The range is not level.  The oven temperature seems too low or too high.  The oven was not preheated as the recipe calls for. The recipe has never been tested or is not from a reliable source. The pans are not the type or size recommended in the recipe. There is not proper air circulation around pan when baking.  Flame size does not fit the cooking utensil being used. When broiling, you have not completely closed the oven door.	Level range. (See Installation Instructions.) Adjust the oven temperature control. (See "Adjusting the oven temperature control" on page 15.) Preheat oven if called for in recipe.  Use only tested recipes from a reliable source.  Refer to a reliable cookbook for recommended pan type and size. Allow 1½ to 2 inches (4-5 cm) on all sides of the pans for air circulation. There must be a minimum space of 1 inch (2.5 cm). Adjust flame size to fit cooking utensil.  Completely close oven door.
<b>The display shows "PF"</b>	There has been a power failure.	Reset the clock. (See page 12.)
<b>"F1" or "F3" shows in the display</b>		Call for service. (See Step 3 on page 39.)

## **2. If you need assistance ...**

Call Whirlpool Consumer Assistance Center telephone number. Dial free from anywhere in the U.S.:

**1-800-253-1301**

and talk with one of our trained consultants. The consultant can instruct you in how to obtain satisfactory operation from your appliance or, if service is necessary, recommend a qualified service company in your area.

If you prefer, write to:

Mr. William Clark  
Consumer Assistance Representative  
Whirlpool Corporation  
2000 M-63  
Benton Harbor, MI 49022

Please include a daytime phone number in your correspondence.

## **3. If you need service ...**



Whirlpool has a nationwide network of authorized Whirlpool<sup>SM</sup> service companies. Whirlpool service technicians are trained to fulfill the product warranty and provide after-warranty service, anywhere in the United States. To locate the authorized Whirlpool service company in your area, call our Consumer Assistance Center telephone number (see Step 2) or look in your telephone directory Yellow Pages under:

• **APPLIANCE-HOUSEHOLD-MAJOR, SERVICE & REPAIR**  
- See: Whirlpool Appliances or Authorized Whirlpool Service  
(Example: XYZ Service Co.)

• **WASHING MACHINES & DRYERS, SERVICE & REPAIR**  
- See: Whirlpool Appliances or Authorized Whirlpool Service  
(Example: XYZ Service Co.)

## **4. If you need FSP® replacement parts ...**

FSP is a registered trademark of Whirlpool Corporation for quality parts. Look for this symbol of quality whenever you need a replacement part for your Whirlpool appliance. FSP replacement parts will fit right and work right, because they are made to the same exacting specifications used to build every new Whirlpool appliance.

To locate FSP replacement parts in your area, refer to Step 3 above or call the Whirlpool Consumer Assistance Center number in Step 2.

## **5. If you are not satisfied with how the problem was solved ...**

- Contact the Major Appliance Consumer Action Panel (MACAP). MACAP is a group of independent consumer experts that voices consumer views at the highest levels of the major appliance industry.
- Contact MACAP only when the dealer, authorized servicer and Whirlpool have failed to resolve your problem.  
Major Appliance Consumer Action Panel  
20 North Wacker Drive  
Chicago, IL 60606
- MACAP will in turn inform us of your action.

# WHIRLPOOL® Gas Cooking Product Warranty

LENGTH OF WARRANTY	WHIRLPOOL WILL PAY FOR
<b>FULL ONE-YEAR WARRANTY</b> From Date of Purchase	FSP® replacement parts and repair labor to correct defects in materials or workmanship. Service must be provided by an authorized Whirlpool <sup>SM</sup> service company.
<b>WHIRLPOOL WILL NOT PAY FOR</b>	
<p><b>A. Service calls to:</b></p> <ol style="list-style-type: none"> <li>1. Correct the installation of the cooking product.</li> <li>2. Instruct you how to use the cooking product.</li> <li>3. Replace house fuses or correct house wiring or plumbing.</li> <li>4. Replace owner accessible light bulbs.</li> </ol> <p><b>B. Repairs when the cooking product is used in other than normal, single-family household use.</b></p> <p><b>C. Pickup and delivery.</b> This product is designed to be repaired in the home.</p> <p><b>D. Damage to the cooking product caused by accident, misuse, fire, flood, acts of God or use of products not approved by Whirlpool.</b></p> <p><b>E. Repairs to parts or systems caused by unauthorized modifications made to the appliance.</b></p>	

8-92

WHIRLPOOL CORPORATION SHALL NOT BE LIABLE FOR INCIDENTAL OR CONSEQUENTIAL DAMAGES. Some states do not allow the exclusion or limitation of incidental or consequential damages, so this limitation or exclusion may not apply to you. This warranty gives you specific legal rights, and you may also have other rights which vary from state to state.

Outside the United States, a different warranty may apply. For details, please contact your authorized Whirlpool distributor or military exchange.

If you need service, first see the "Assistance or Service" section of this book. After checking "Assistance or Service," additional help can be found by calling our Consumer Assistance Center telephone number, 1-800-253-1301, from anywhere in the U.S.