

**COOKTOP**

**ELEMENT SIZE INDICATORS**

Some cooktop zone positions have up to 3 element sizes. You may use the single inner heating ring only or add 1 or 2 more rings with each press of the BURNER SIZE.

Number of circles = number of heating rings available.

- 1 circle = single element
- 2 circles = double element (some positions)
- 3 circles = triple element (left front position) (some positions)

**SETTING the COOKTOP**

- If needed, wake the control panel.
- Touch the ON OFF key for desired heating zone.
- If heating zone has more than 1 ring size available, press and continue to press the BURNER SIZE for desired element size.
- Press the desired power level key (hi+, med, or lo-) or for more precise level settings use the hi+ or lo- keys to make specific level changes.

**SETTINGS for COOKTOP ZONES**

HI (8-Hi)	Start foods, bring water to boil, pan broiling
MED HI (5-8)	Continue rapid boil fry
MED (3-5)	Maintain slow boil, thicken sauces, steam vegetables
MED LO (2-3)	Keep foods cooking, poach, stew
LO (Lo-2)	Keep warm, melt, simmer

**SETTINGS for COOKTOP ZONES**

Food item	Heat level
Hot beverages	L4 or L5
Fried foods	L4 or L5
Vegetables	L3
Soups (cream)	L3
Stews	L3
Sauces	L3
Meats	L3
Gravies	L2 or L1
Eggs	L2 or L1
Dinner plates with food	L1
Casseroles	L1
Breads/pasteries	L1

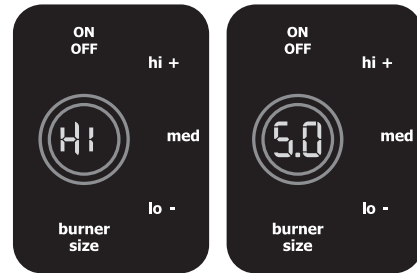
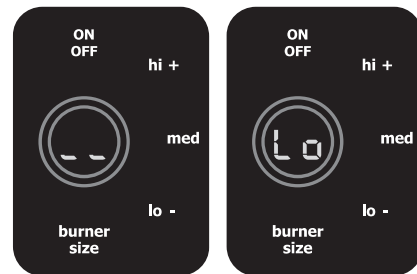
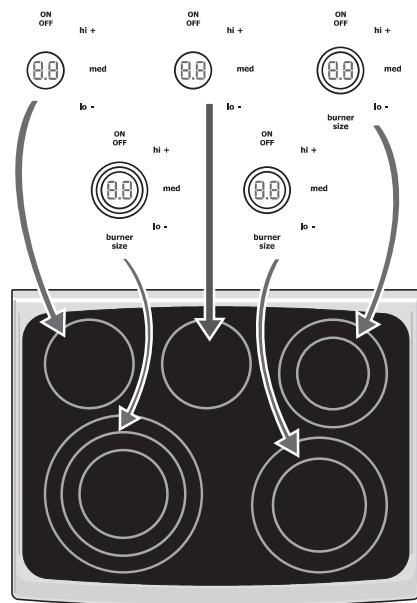

**WARMER ZONE DISPLAY**

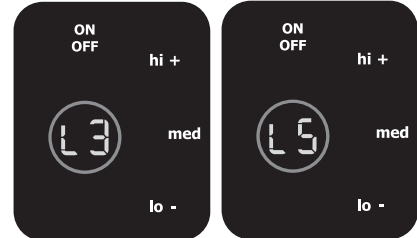
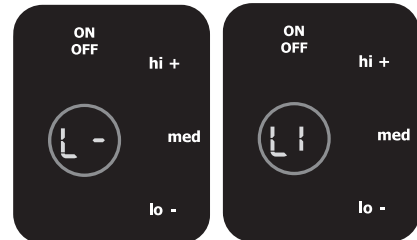

**LUXURY-GLIDE™ RACKS**

**REMOVING GLIDE RACKS**

**CAUTION**

Always use potholders or oven mitts when removing food or adjusting the oven racks. Wait until the oven has completely cooled if possible. Oven racks may be **HOT** and may cause burns.

Use thumbs to press in on both left and right spring-loaded release levers - Fig. 1-. Place the remainder of both hands over the upper front of the glide rack. While pressing in on both levers, pull the rack straight out **slightly** and release thumb levers. Using both hands grasp **both the upper and lower portions** of the glide rack (-Fig. 1); pull rack using both hands straight out until reaching the stop position -Fig 2-. At the stop, lift up front of rack slightly and continue to pull rack away from oven -Fig 3-. Be sure to hold on both upper and lower rack portions when removing from or handling rack outside of the oven - these rack portions move independently and are difficult to handle unless held together.

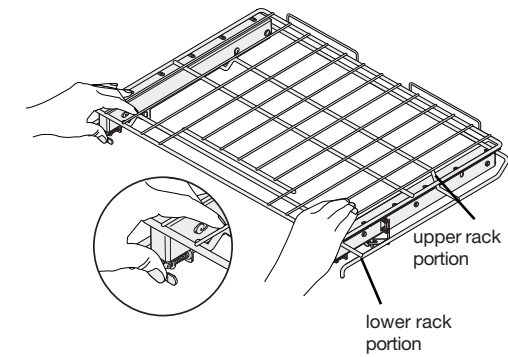

Fig. 1

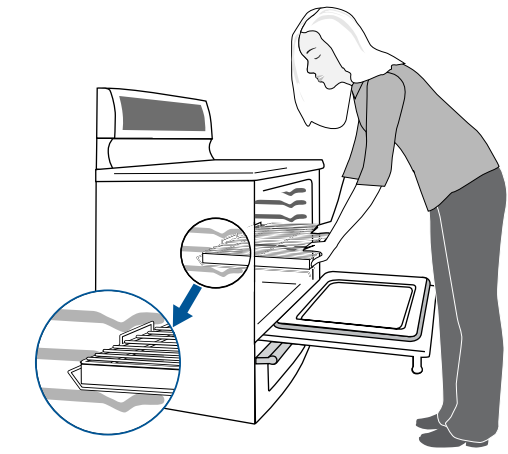

Fig. 2

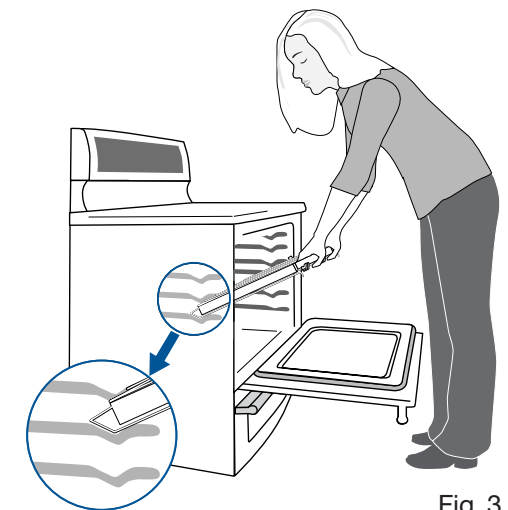
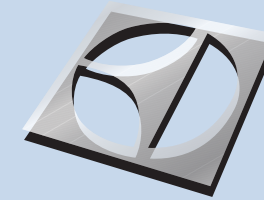

Fig. 3

**REPLACING GLIDE RACKS**

Grasp **both upper and lower portions** of glide rack, lift and place the rack resting evenly between the oven cavity walls. Tilt the front of the rack upward slightly and slide the rack completely into position. Some force may be necessary to make sure the oven rack has snapped completely back into place.



**Quick Reference**

**30" Free-Standing Electric Range**

Thank you for choosing Electrolux, the new premium brand in home appliances. We have provided you with this guide so that you may begin using your appliance right away.

**SETTING CLOCK AT POWER UP**

You will be prompted to enter the time of day in the event of a power failure or when you first provide power to your appliance.

- When your appliance is first powered up, 12:00 will flash in the display.
- Enter the time of day using the numeric key pads and press **START** to set.

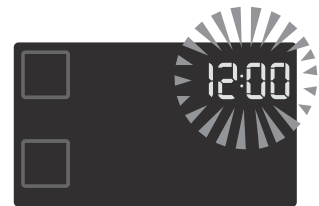

If an invalid time of day is entered, the control will triple beep. Re-enter a valid time of day and press **START**. If **CANCEL** is pressed your clock will start with a time of 12:00.

**WAVE TOUCH™ DISPLAY MODES**

**SLEEP MODE**

Your Wave Touch™ control will remain in a sleep mode when not in use. Only the clock will display during this mode. You will need to wake the control to begin an oven or cooktop feature.

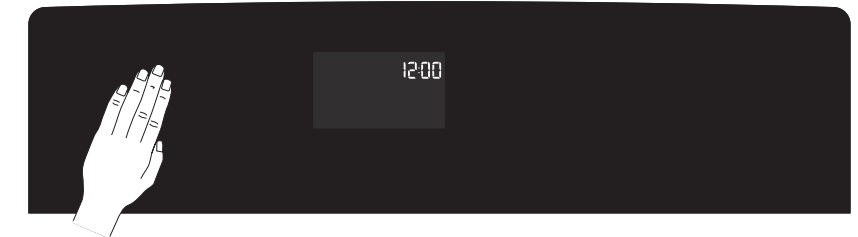

**AWAKE MODE**

To wake the control touch within the display panel in the general area shown. After 2 minutes without activity, go back into sleep mode. To start cooking you must select either the upper oven, lower oven or a cooktop element. User preferences will be available during this mode as well as timers, oven light and the control lock.

