













Use & Care Manual

Gas Range

*ES400 Controls, Self-Cleaning Oven
with Sealed Surface Burners
Convection Bake & Roast*



Visit the Frigidaire Web Site at:
<http://www.frigidaire.com>

Welcome	2	
Important Safety Instructions ..	3-5	
Features at a Glance	6-7	
Setting Surface Controls ..	8-10	
Surface Cooking	10	
Before Setting Oven Controls Setting Warmer Drawer Controls	11-12	
Control Pad Features	13	
Setting Oven Controls	14-24	
Self-Cleaning	25-28	
Adjusting Your Oven Temperature	28	
Care & Cleaning	29-31	
Before You Call Solutions to Common Problems	32-33	
Convection Cooking Tables	34	
Warranty	Back Cover	



Welcome & Congratulations

Questions?

1-800-944-9044

(United States)

1-866-729-5199

(Canada)

Please attach sales receipt here for future reference.

Congratulations on your purchase of a new range! At **Electrolux Home Products**, we are very proud of our product and are completely committed to providing you with the best service possible. Your satisfaction is our number one priority.

We know you'll enjoy your new range and **Thank You** for choosing our product. We hope you consider us for future purchases.

PLEASE CAREFULLY READ AND SAVE THESE INSTRUCTIONS

This Use & Care Manual provides specific operating instructions for your model. Use your range only as instructed in this manual. These instructions are not meant to cover every possible condition and situation that may occur. Common sense and caution must be practiced when installing, operating and maintaining any appliance.

Please record your model and serial numbers below for future reference.

Model Number: _____

Serial Number: _____

Purchase Date: _____

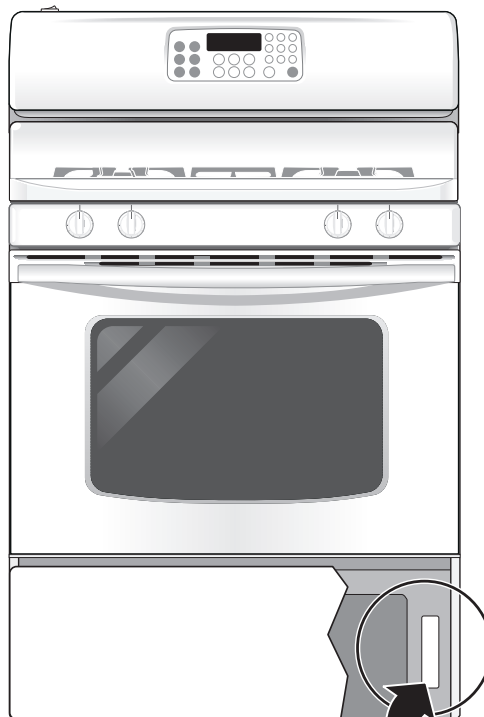

Serial plate location:
Open storage or warmer drawer.

Product Registration

Register Your Product

The self-addressed **PRODUCT REGISTRATION CARD** should be filled in completely, signed and returned to Electrolux Home Products.

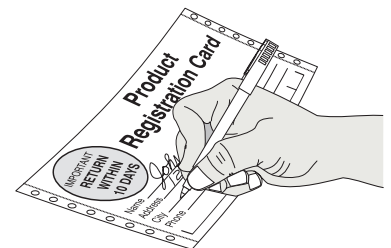

This Use & Care Manual contains general operating instructions for your range and feature information for several models. Your range **may not** have all the described features. The graphics shown are representative. The graphics on your range may not look exactly like those shown.

Important Safety Instructions



**Read all instructions before using this appliance.
Save these instructions for future reference.**

This manual contains important safety symbols and instructions. Please pay attention to these symbols and follow all instructions given.

WARNING This symbol will help alert you to situations that may cause serious bodily harm, death or property damage.

CAUTION This symbol will help alert you to situations that may cause bodily injury or property damage.

WARNING If the information in this manual is not followed exactly, a fire or explosion may result causing property damage, personal injury or death.

FOR YOUR SAFETY:

- Do not store or use gasoline or other flammable vapors and liquids in the vicinity of this or any other appliance.
- **WHAT TO DO IF YOU SMELL GAS:**
 - Do not try to light any appliance.
 - Do not touch any electrical switch; do not use any phone in your building.
 - Immediately call your gas supplier from a neighbor's phone. Follow the gas supplier's instructions.
 - If you cannot reach your gas supplier, call the fire department.
- Installation and service must be performed by a qualified installer, servicer or the gas supplier.

WARNING

- All ranges can tip.
- Injury to persons could result.
- Install anti-tip device packed with range.
- See Installation Instructions.



WARNING To reduce the risk of tipping, the range must be secured by properly installed anti-tip bracket provided with the range. To check if the bracket is installed properly, visually check that rear leveling leg is inserted into and fully secured by the anti-tip bracket by removing lower panel or storage drawer. For models with a warmer drawer, grasp the top rear edge of the range and carefully attempt to tilt it forward. Refer to the installation instructions for proper anti-tip bracket installation.

- **Remove all tape and packaging before using the range.**
Destroy the carton and plastic bags after unpacking the range. Never allow children to play with packaging material.

- **Proper Installation—Be sure your appliance is properly installed and grounded by a qualified technician in accordance with the National Fuel Gas Code ANSI Z223.-latest edition, or in Canada CAN/CGA B149.1, and CAN/CGA B149.2, and the the National Electrical Code ANSI/NFPA No.70-latest edition, or in Canada CSA Standard C22.1, Canadian Electrical Code, Part 1, and local code requirements.** Install only per installation instructions provided in the literature package for this range.

Ask your dealer to recommend a qualified technician and an authorized repair service. Know how to disconnect the power to the range at the circuit breaker or fuse box in case of an emergency.

- **User servicing—Do not repair or replace any part of the appliance unless specifically recommended in the manuals.** All other servicing should be done only by a qualified technician, This may reduce the risk of personal injury and damage to the range.
- **Never modify or alter the construction of a range by removing leveling legs, panels, wire covers, anti-tip brackets/screws, or any other part of the product.**

WARNING Stepping, leaning or sitting on the doors or drawers of this range can result in serious injuries and also cause damage to the range. Do not allow children to climb or play around the range. The weight of a child on an open door may cause the range to tip, resulting in serious burns or other injury.

WARNING Do not use the oven or warmer drawer (if equipped) for storage.

CAUTION Do not store items of interest to children in the cabinets above a range or on the backguard of a range. Children climbing on the range to reach items could be seriously injured.

WARNING Never Use Your Appliance for Warming or Heating the Room.

- **Storage in or on Appliance—Flammable materials should not be stored in an oven, warmer drawer, near surface burners or in the storage drawer.** This includes paper, plastic and cloth items, such as cookbooks, plasticware and towels, as well as flammable liquids. Do not store explosives, such as aerosol cans, on or near the range.



Important Safety Instructions

- **Do Not Leave Children Alone**—Children should not be left alone or unattended in the area where appliance is in use. They should never be allowed to sit or stand on any part of the appliance.
- **DO NOT TOUCH SURFACE BURNERS, AREAS NEAR THESE BURNERS, OVEN BURNERS OR INTERIOR SURFACES OF THE OVEN.** Both surface and oven burners may be hot even though flames are not visible. Areas near surface burners may become hot enough to cause burns. During and after use, do not touch, or let clothing or other flammable materials touch these areas until they have had sufficient time to cool. Among these areas are the cook top, surfaces facing the cook top, the oven vent openings and surfaces near these openings, oven door and window.
- **Wear Proper Apparel**—Loose-fitting or hanging garments should never be worn while using the appliance. Do not let clothing or other flammable materials contact hot surfaces.
- **Do Not Use Water or Flour on Grease Fires**—Smother the fire with a pan lid, or use baking soda, a dry chemical or foam-type extinguisher.
- **When heating fat or grease, watch it closely.** Fat or grease may catch fire if allowed to become too hot.
- **Use Only Dry Potholders**—Moist or damp potholders on hot surfaces may result in burns from steam. Do not let potholders touch hot heating burners. Do not use a towel or other bulky cloth instead of a potholder.
- **Do Not Heat Unopened Food Containers**—Buildup of pressure may cause container to burst and result in injury.
- **Remove the oven door from any unused range if it is to be stored or discarded.**

IMPORTANT—ELECTRIC IGNITION MODELS ONLY: Do not attempt to operate the oven during a power failure. If the power fails, always turn off the oven. If the oven is not turned off and the power resumes, the oven will begin to operate again. Once the power resumes, reset the clock and oven function.

IMPORTANT INSTRUCTIONS FOR USING YOUR COOKTOP

⚠️ WARNING Use Proper Flame Size—Adjust flame size so it does not extend beyond the edge of the utensil. The use of undersized utensils will expose a portion of the burner flame to direct contact and may result in ignition of clothing. Proper relationship of utensil to flame will also improve efficiency.

- **Know which knob controls each surface burner.** Place a pan of food on the burner before turning it on, and turn the burner off before removing the pan.
- **Always turn knob to the full LITE position when igniting top burners.** Visually check that burner has lit. Then adjust the flame so it does not extend beyond the edge of the utensil.
- **Utensil Handles Should Be Turned Inward and Not Extend Over Adjacent Surface Burners**—To reduce the risk of burns, ignition of flammable materials, and spillage due to unintentional contact with the utensil, the handle of the utensil should be positioned so that it is turned inward, and does not extend over adjacent surface burners.
- **Never Leave Surface Burners Unattended at High Heat Settings**—Boilovers cause smoking and greasy spillovers that may ignite, or a pan that has boiled dry may melt.

- **Protective Liners**—Do not use aluminum foil to line surface burner pans, or oven bottom, except as suggested in this manual. Improper installation of these liners may result in risk of electric shock, or fire.
- **Glazed Cooking Utensils**—Only certain types of glass, glass/ceramic, ceramic, earthenware, or other glazed utensils are suitable for cooktop service without breaking due to the sudden change in temperature. Check the manufacturer's recommendations for cooktop use.

IMPORTANT INSTRUCTIONS FOR USING YOUR OVEN

- **Use Care When Opening Oven Door or Warmer Drawer**—Stand to the side of the range when opening the door of a hot oven. Let hot air or steam escape before you remove or replace food in the oven.
- **Keep Oven Vent Ducts Unobstructed.** The oven vent is located below the backguard. Touching the surfaces in this area when the oven is operating may cause severe burns. Also, do not place plastic or heat-sensitive items on or near the oven vent. These items could melt or ignite.
- **Placement of Oven Racks.** Always place oven racks in desired location while oven is cool. If rack must be moved while oven is hot use extreme caution. Use potholders and grasp the rack with both hands to reposition. Do not let potholders contact the hot heating elements in the oven. Remove all utensils from the rack before moving.
- **Do not use the broiler pan without its insert.** The broiler pan and its insert allow dripping fat to drain and be kept away from the high heat of the broiler.
- **Do not cover the broiler insert with aluminum foil. Exposed fat and grease could ignite.**
- Cold temperatures can damage the electronic control. When using the appliance for the first time, or when the appliance has not been used for an extended period of time, be certain the unit has been in temperatures above 32°F (0°C) for at least 3 hours before turning on the power to the appliance.

IMPORTANT INSTRUCTIONS FOR CLEANING YOUR RANGE

- **Clean the range regularly to keep all parts free of grease that could catch fire.** Pay particular attention to the area in and around each surface burner. Do not allow grease to accumulate. Refer to the range manufacturer's instructions for cleaning.
- **Kitchen cleaners and aerosols**—Always follow the manufacturer's recommended directions for use. Be aware that excess residue from cleaners and aerosols may ignite causing damage and injury.

SELF CLEANING OVENS

- **Clean in the self-cleaning cycle only the parts listed in this Owner's Guide.** Before self cleaning the oven, remove the broiler pan and any utensils or foods from the oven.
- **Do Not Use Oven Cleaners**—No commercial oven cleaner or oven liner protective coating of any kind should be used in or around any part of the oven.
- **Do Not Clean Door Gasket**—The door gasket is essential for a good seal. Care should be taken not to rub, damage or move the gasket.

Important Safety Instructions



Grounding type
wall receptacle

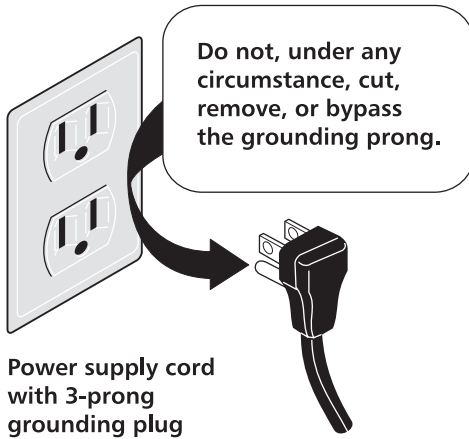

Power supply cord
with 3-prong
grounding plug

GROUNDING INSTRUCTIONS

(electric ignition models only)

⚠ WARNING Avoid fire hazard or electrical shock. Do not use an adapter plug, an extension cord, or remove grounding prong from electrical power cord. Failure to follow this warning can cause serious injury, fire or death.

⚠ WARNING This appliance is equipped with a 3-prong grounding plug for your protection against shock hazard and should be plugged directly into a properly grounded receptacle. **DO NOT** cut or remove the grounding prong from this plug.

For personal safety, the range must be properly grounded. For maximum safety, the power cord must be plugged into an electrical outlet that is correctly polarized and properly grounded.

If a 2-prong wall receptacle is the only available outlet, it is the personal responsibility of the consumer to have it replaced with a properly grounded 3-prong wall receptacle installed by a qualified electrician.

See the **INSTALLATION INSTRUCTIONS** packaged with this range for complete installation and grounding instructions.

IMPORTANT SAFETY NOTICE

The California Safe Drinking Water and Toxic Enforcement Act requires the Governor of California to publish a list of substances known to the state to cause cancer, birth defects or other reproductive harm, and requires businesses to warn customers of potential exposure to such substances.

Conversion to Liquefied Petroleum (L.P.) Gas

The range is designed to allow for conversion to Liquefied Petroleum (L.P.) Gas. Contact your qualified appliance distributor to obtain the proper L.P. Kit. Follow the L.P. Kit Installation Instructions carefully.

READ AND SAVE THESE INSTRUCTIONS



Features At A Glance

Your Gas Range Features At a Glance

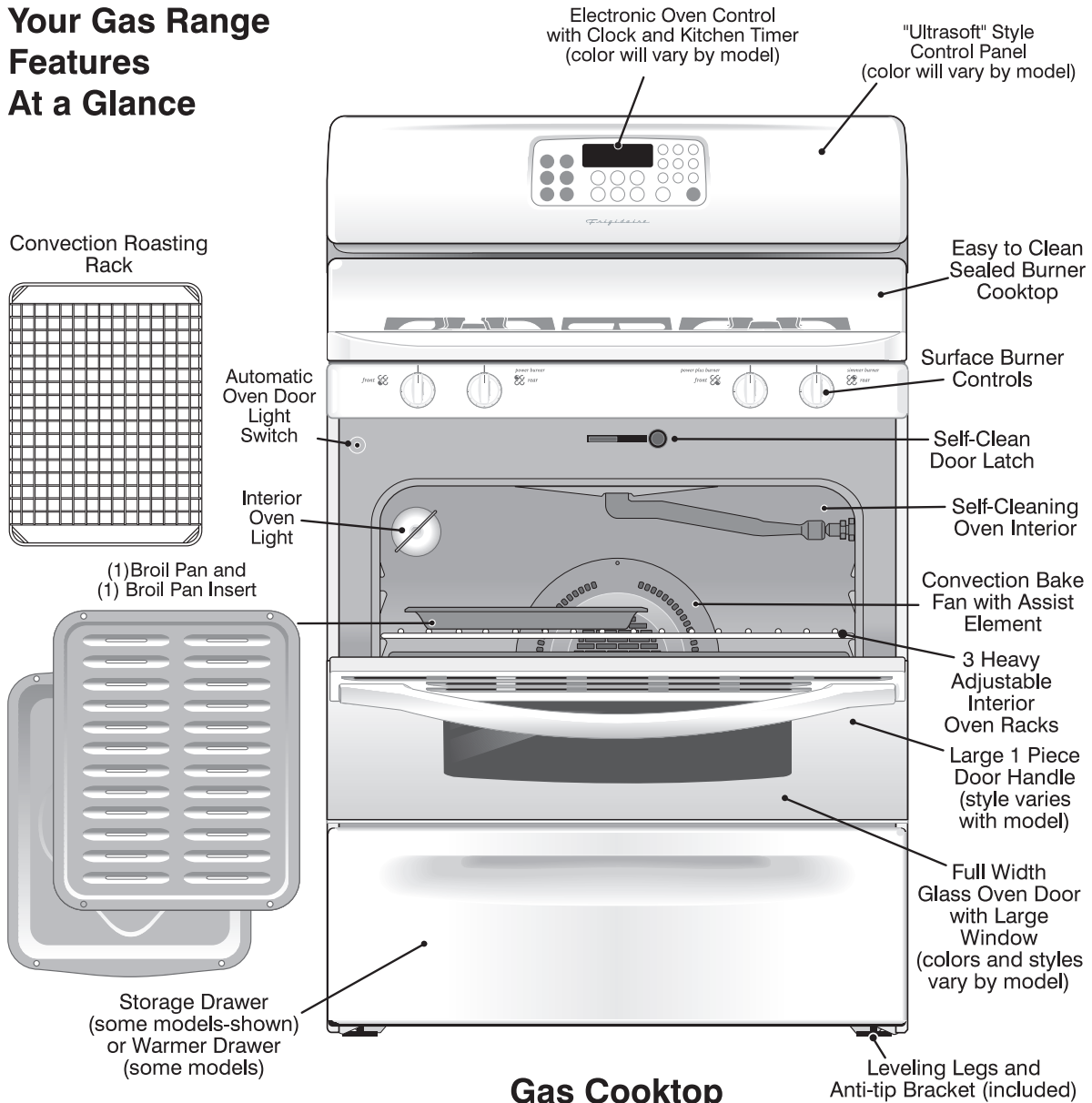

Gas Cooktop

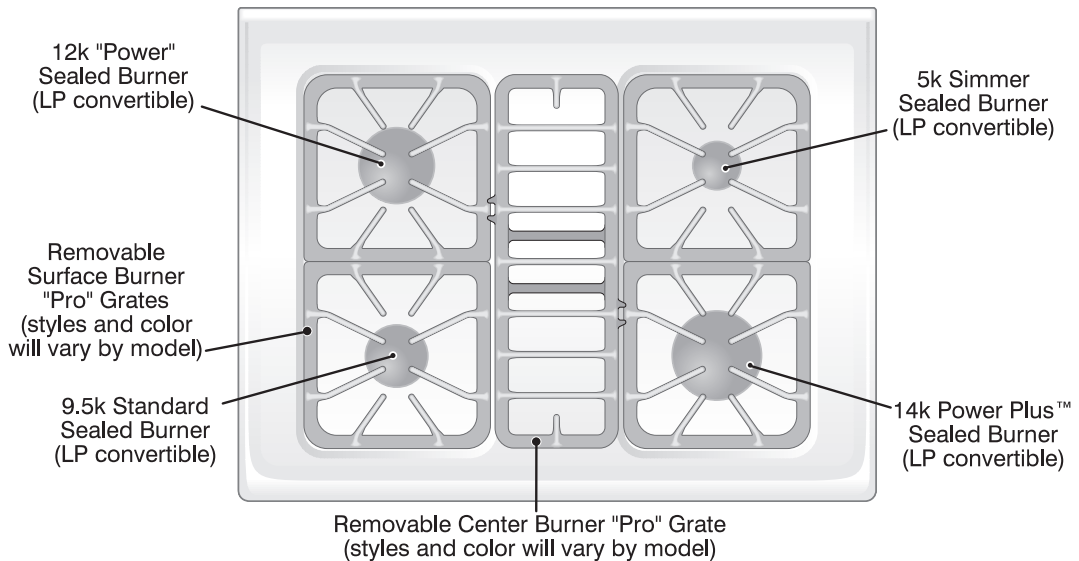

Features At A Glance



Your Gas Range Features At a Glance (Stainless Steel models only)

Convection Roasting Rack

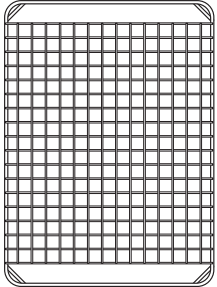

(1) Broil Pan and (1) Broil Pan Insert

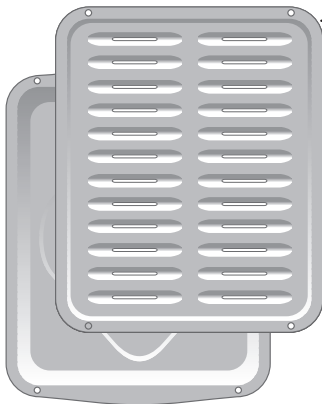

Warmer Drawer (shown) and Rack with Stainless Steel Handle

Warmer Drawer Control and Indicator Light

Electronic Oven Control with Clock and Kitchen Timer (color will vary by model)

Brushed Aluminum "Ultrasoft" Style Control Panel

Easy to Clean Sealed Burner Cooktop

Brushed Aluminum Manifold Panel

Surface Burner Controls

Self-Clean Door Latch

Self-Cleaning Oven Interior

Convection Bake Fan with Assist Element

3 Heavy Adjustable Interior Oven Racks

Large Stainless Steel 1 Piece Door Handle

Full Width Stainless Steel Oven Door with Large Window

Leveling Legs and Anti-tip Bracket (included)

Gas Cooktop

12k "Power" Sealed Burner (LP convertible)

5k Simmer Sealed Burner (LP convertible)

Removable Surface Burner "Pro" Grates (styles and color will vary by model)

9.5k Standard Sealed Burner (LP convertible)

14k Power Plus™ Sealed Burner (LP convertible)

Removable Center Burner "Pro" Grate (styles and color will vary by model)



Setting Surface Controls

Sizes of the Surface Gas Burners

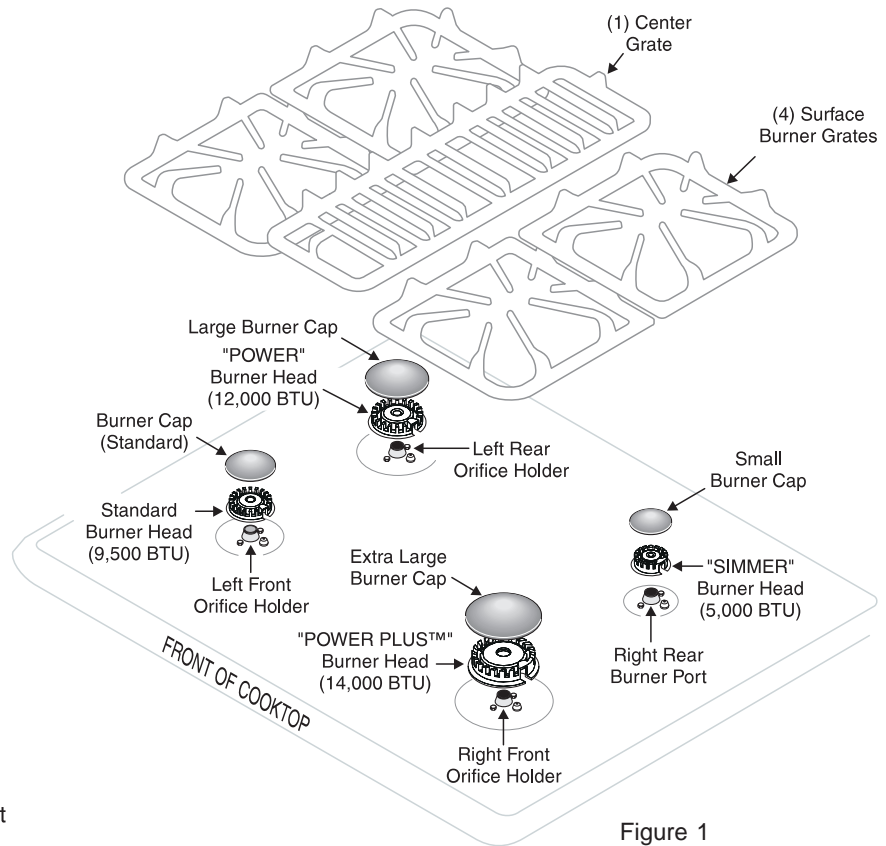
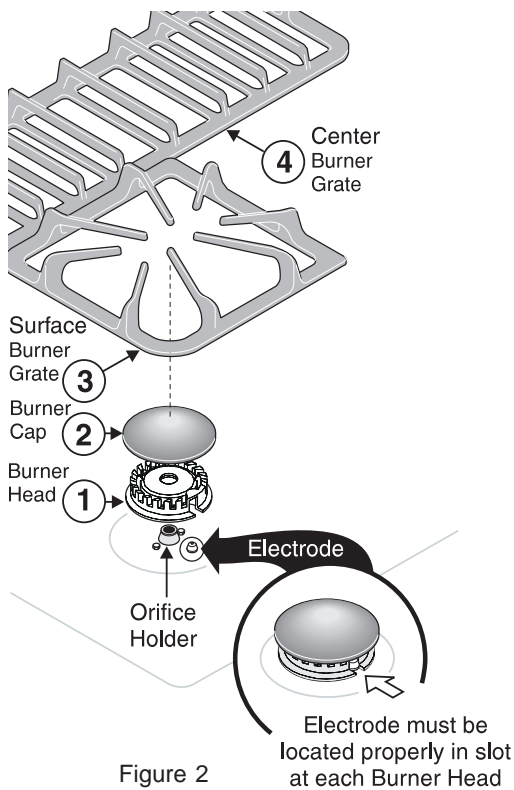

Your gas range was supplied with 4 different surface gas burners; a "SIMMER" Burner (5,000 BTU), a STANDARD burner (9,500 BTU), a "POWER" Burner (12,000 BTU) and a **POWER PLUS™** Burner (14,000 BTU). When setting up the gas range for the first time, make sure that the correct Burner Heads, Burner Caps and Burner Grates are correctly (See Fig. 1).

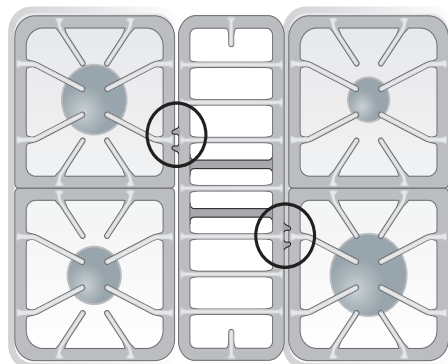

Center grate should lock into these 2 locations with surface grate fingers.

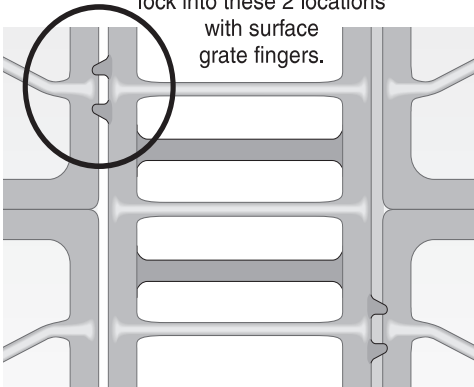

Figure 3

Assembly of the Surface Burner Heads, Burner Caps and Burner Grates:

It is very important to make sure that all of the Surface Burner Heads, Surface Burner Caps and Surface Burner Grates are installed correctly and in the correct locations.

1. Place all 4 Burner Heads in the correct locations (See Fig. 1). Make sure that the correct Burner Head is placed with the corresponding Orifice Holder and that the Electrode is located properly in the slot provided of each Burner Head (See Fig. 2). Proper Burner Head placement insures that each Burner will have the correct spark required for gas ignition.
2. Place the correct Burner Caps at each of the burner locations. Each of the 4 Burner Heads **MUST** have a Burner Cap installed to insure proper ignition and gas flame size before placing the Burner Grates (See Fig. 2).
3. Place the 4 cast iron surface Burner Grates supplied with the range. After the surface grates been installed place the center grate between the four grates and be sure to interlock the grates correctly (See Fig. 3).

REMEMBER — DO NOT ALLOW SPILLS, FOOD, CLEANING AGENTS OR ANY OTHER MATERIAL TO ENTER THE GAS ORIFICE HOLDER OPENING. Always keep the Burner Caps and Burner Heads in place whenever the surface burners are in use.

Setting Surface Controls

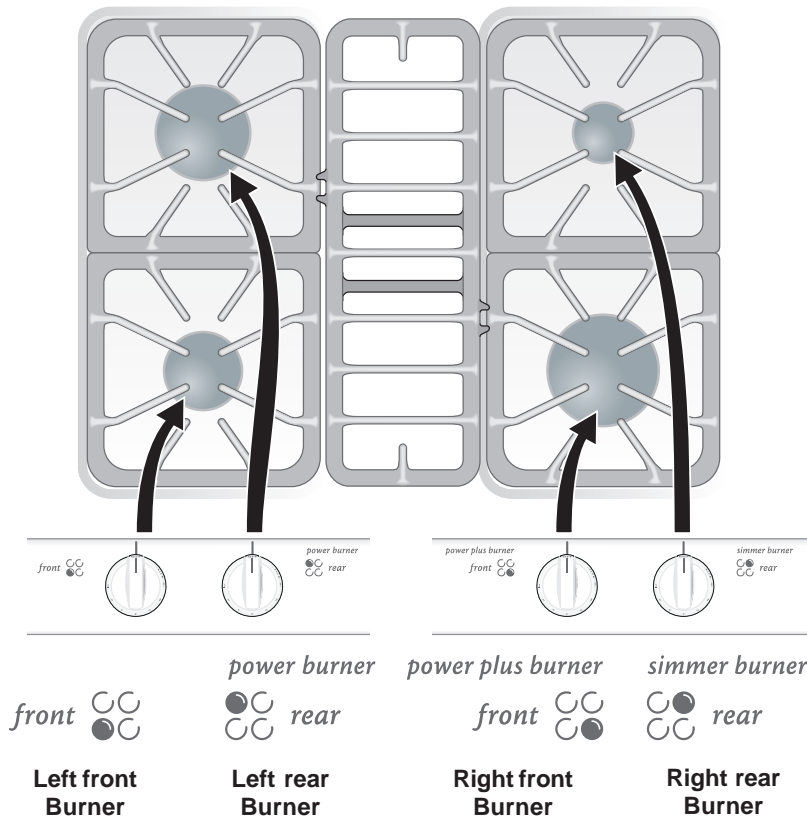

Figure 1

Control Locations of the Gas Surface Burners

Your range is equipped with gas surface burners with 4 different BTU ratings. The ability to heat food quicker and in larger volumes increases as the burner size increases.

The smaller **SIMMER** burner is best used for simmering delicate sauces, etc. This burner is located at the right rear burner position on the cooktop (See Fig. 1).

The **STANDARD** size burner can be used for most surface cooking needs. This burner is located at the left front burner position on the cooktop (See Fig. 1).

The larger 2 **POWER** and **POWER PLUS™** burners are best used for bringing large quantities of liquid rapidly up to temperature or when preparing larger quantities of food. The two **POWER** and **POWER PLUS™** Burners are located at the left rear and right front burner (See positions on the cooktop as shown in Fig. 1).

Operating the Gas Surface Burner Controls:

1. Place cooking utensil on surface burner.
2. Push the surface control knob in and turn **counterclockwise** out of the OFF position (See Fig. 2).
3. Release the knob and rotate to the LITE position. Note: All four electronic surface igniters will spark at the same time. However, only the burner you are turning on will ignite.
4. Visually check that the burner has a flame.
5. Turn the control knob **counterclockwise** to the desired flame size. The control knobs do not have to be set at a particular setting. Use the knob indicator settings to adjust the flame as needed. **DO NOT** cook with the surface control knob in the LITE position. (The electronic ignitor will continue to spark if the knob is left in the LITE position.)

CAUTION Do not place plastic items such as salt and pepper shakers, spoon holders or plastic wrappings on top of the range when it is in use. These items could melt or ignite. Potholders, towels or wood spoons could catch fire if placed too close to a flame.

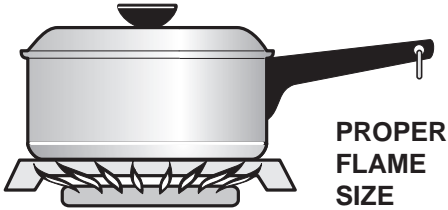

Figure 2



Surface Cooking

Setting Proper Surface Burner Flame Size



For most cooking - start on the highest control setting and then turn to a lower one to complete the process. Use the recommendations below as a guide for determining proper flame size for various types of cooking. The size and type of utensil used and the amount of food being cooked will influence the setting needed.

***Flame Size**

Type of Cooking

High Flame

Start most foods; bring water to a boil; pan broiling.

Medium Flame

Maintain a slow boil; thicken sauces, gravies; steaming.

Low Flame

Keep foods cooking; poach; stewing.

For deep fat frying - use a thermometer and adjust the surface control knob accordingly. If the fat is too cool, the food will absorb the fat and be greasy. If the fat is too hot, the food will brown so quickly that the center will be undercooked. Do not attempt to deep fat fry too much food at once as the food will neither brown nor cook properly.

Never extend the flame beyond the outer edge of the utensil. A higher flame simply wastes heat and energy, and increases the risk of being burned by the gas flame.

***Note: Settings are based on using medium-weight metal or aluminum pans. Settings may vary when using other types of pans.** The color of the flame is the key to proper burner adjustment. A good flame is clear, blue and hardly visible in a well-lighted room. Each cone of flame should be steady and sharp. Adjust or clean burner if flame is yellow-orange.

Before Setting Oven Controls



Arranging the Oven Racks

ALWAYS ARRANGE OVEN RACKS WHEN THE OVEN IS COOL (PRIOR TO OPERATING THE OVEN). Always use oven mitts when the oven is hot.

Oven Vent Location

The oven vent is located **below the backguard**. When the oven is on, hot air is released through the vents. This venting is necessary for proper air circulation in the oven and good baking results.

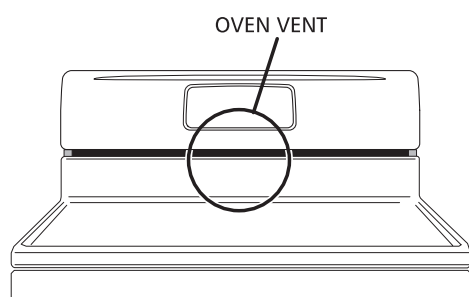

Removing and Replacing Oven Racks

To remove, pull the rack forward until it stops. Lift up front of rack and slide out. **To replace**, fit the rack onto the guides on the oven walls. Tilt the front of the rack upward and slide the rack back into place.

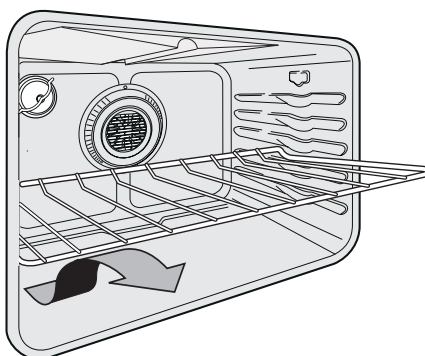

Arranging Oven Racks

To bake on a single rack, place the rack in position 4. **To bake on 2 racks**, place the racks in positions 2 and 4. **To bake on 3 racks**, place the racks in positions 1, 3 and 5.

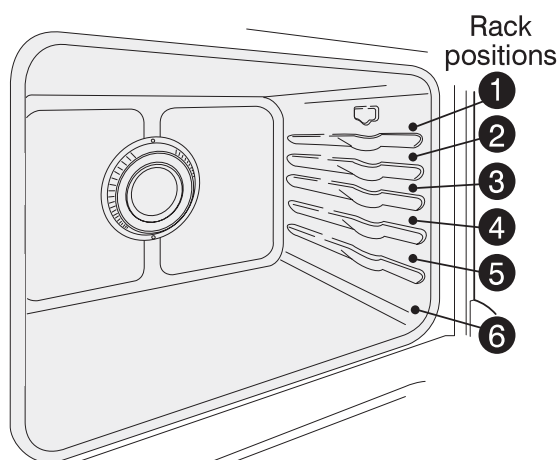
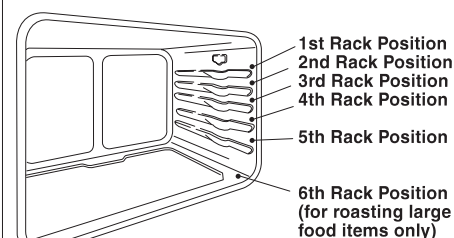

RECOMMENDED RACK POSITIONS FOR BROILING, BAKING & ROASTING

Food	Rack Position
Broiling meats, chicken or fish	1, 2 or 3
Cookies, cakes, pies, biscuits & muffins	3 or 4
Frozen pies, angel food cake, yeast, bread, casseroles, small cuts of meat or poultry	5
Turkey, roast or ham	6

Note: Always use caution when removing food from the lower rack positions.

Air Circulation in the Oven

If using 1 rack, place in center of oven. If using multiple racks, stagger cookware as shown.

For best air circulation and baking results allow 2-4" (5-10 cm) around the cookware for proper air circulation and be sure pans and cookware do not touch each other, the oven door, sides or back of the oven cavity. The hot air must circulate around the pans and cookware in the oven for even heat to reach around the food.

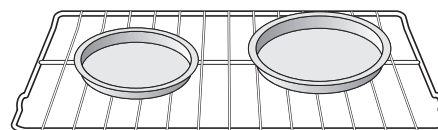

1 Oven Rack

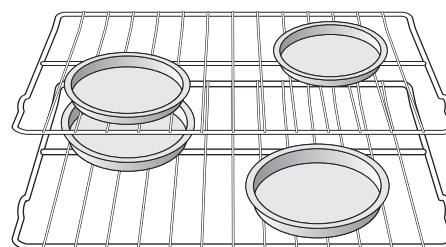

Multiple Oven Racks



Setting Warming Drawer Controls

(some models)

Arranging Warming Drawer Rack Positions

The rack can be used in 2 ways:

- In the **upright position** to allow low profile food items to be placed both under and on top of the rack (for example, rolls or biscuits on top of the rack and a casserole dish underneath).
- In the **downward position** to allow you to place light weight food items and empty cookware (for example, rolls or pastries and dinner plates) on the rack.

Set the Warming Drawer rack in either position as shown below (Fig. 1).

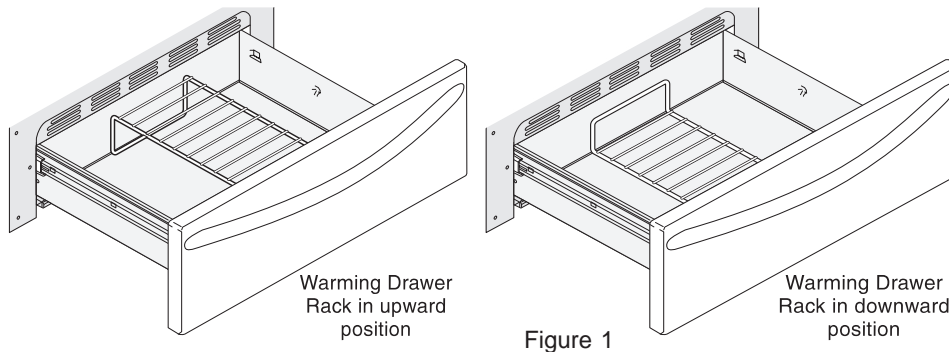

To Operate the Warming Drawer

The purpose of the Warming Drawer is to keep hot cooked foods at serving temperature. Always start with hot food. It is not recommended to heat cold food in the Warming Drawer.

All food placed in the Warming Drawer should be covered with a lid or aluminum foil to maintain quality. **Do not use plastic wrap to cover food. Plastic may melt onto the drawer and be very difficult to clean.** Use only utensils and cookware recommended for oven use in the Warming Drawer.

To Set the Warming Drawer Control

The control is used to select the temperature of the Warming Drawer. It is located on the control panel. To set the control, push in and turn the knob to the desired setting. The temperatures are approximate and are designated by **HI** (high), **MED** (medium) and **LO** (low). To set the Warming Drawer control:

1. Turn the knob to select the desired temperature setting.
2. For best results, preheat the drawer before adding food. An empty drawer will preheat in approximately 15 minutes.
3. When done, turn the control to **OFF**.

Warming Drawer Temperature Selection

Recommended Warming Drawer food settings are shown in Figure 3. If a particular food is not listed, start with the MED setting. If more crispness is desired, remove the lid or aluminum foil from the food. Most foods can be kept at serving temperatures on the MED setting. When a combination of foods are to be kept warm (for example, a meat with 2 vegetables and rolls) use the HI setting. To avoid heat loss, do not open the Warming Drawer while in use.

Warming Drawer Indicator Light

The Warming Drawer indicator light is located above the Warming Drawer control knob (See Fig. 2). It turns on when the control is set, and stays on until the control is turned off. **The warmer drawer will not operate during the self-clean cycle.**

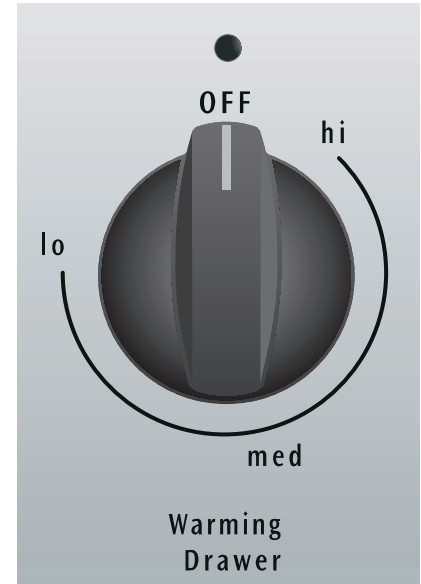

Figure 2

Warming Drawer Recommended Food Settings Table

Food Item	Setting
Bacon	HI
Hamburger Patties	HI
Poultry	HI
Pork Chops	HI
Fried Foods	HI
Pizza	HI
Gravies	MED
Casseroles	MED
Eggs	MED
Roasts (Beef, Pork, Lamb)	MED
Vegetables	MED
Biscuits	MED
Rolls, hard	MED
Pastries	MED
Rolls (soft)	LO
Empty Dinner Plates	LO

Figure 3

CAUTION Always use pot holders or oven mitts when removing food from the warmer drawer as cookware and plates will be hot and you can be burned.

Control Pad Features



READ THE INSTRUCTIONS CAREFULLY BEFORE USING THE OVEN. For satisfactory use of your oven, become familiar with the various features and functions of the oven as described below. **Detailed instructions for each feature and function follow later in this Use & Care Manual.**

CONVECTION BAKE— Use to select the Convection Bake feature (See page 24).

CONVECTION ROAST— Use to select the Convection Roast feature (See page 23).

OVEN LIGHT— Use to turn the oven light on and off (See page 30).

OVEN LOCKOUT— Use to disable all oven features (See page 16).

CLOCK— Use to set the time of day. (See page 14).

0 THRU 9 NUMBER PADS— Used to enter temperature and times.

Diagram of the oven control pad showing buttons for: Conv bake, Conv roast, Bake, Broil, Pre heat, Clean, Light, Lock, Clock, Timer On/Off, Bake time, Stop time, Clear Off, 0, and START. The digital display shows 88:88 and 888°. Below the display are indicators for TIMED, DELAY, TIMER, DOOR LOCKED, CLEAN, CONV, BAKE, BROIL, MINUTS, CAKES, BREW, and OS.

BROIL— Use to select variable Broil feature (See page 22).

BAKE— Use to enter the normal baking feature. (See page 19).

PREHEAT— Use to bring the oven temperature up before placing food (See page 18).

CLEAN— Use to select the Self-Cleaning feature (See page 26).

TIMER ON/OFF— Use to set or cancel the kitchen timer. The kitchen timer does not start or stop cooking (See page 15).

BAKE TIME— Use to enter the length of the baking time.

STOP TIME— Use with **BAKE, COOK TIME, and CLEAN** to program a delayed baking or delayed self-cleaning cycle stop time.

CLEAR/OFF— Use to cancel any oven mode previously entered except the oven lock out, time of day and minute timer. Press **CLEAR/OFF** to stop cooking.

START— Use to start all oven features (not used with Oven Light).

Minimum and Maximum Control Pad Settings

All of the features listed have minimum and maximum time or temperature settings that may be entered into the control. An ENTRY acceptance beep will sound each time a control pad is touched (the Oven Lockout pad is delayed by 3 seconds). An ENTRY ERROR tone (3 short beeps) will sound if the entry of the temperature or time is below the minimum or above the maximum settings for the feature.

FEATURE	MIN. TEMP. /TIME	MAX. TEMP. /TIME
PREHEAT TEMP.	170°F / 77°C	550°F / 288°C
BAKE TEMP.	170°F / 77°C	550°F / 288°C
BROIL TEMP.	400°F / 205°C	HI-550°F / 288°C
KITCHEN TIMER	12 Hr. 0:01 Min.	11:59 Hr./ Min.
	24 Hr. 0:01 Min.	11:59 Hr./ Min.
CLOCK TIME	12 Hr. 1:00 Hr./ Min.	12:59 Hr./ Min.
	24 Hr. 0:00 Hr./ Min.	11:59 Hr./ Min.
OVEN BAKE TIME	12 Hr. 0:01 Min.	11:59 Hr./ Min.
	24 Hr. 0:01 Min.	23:59 Hr./ Min.
STOP TIME	12 Hr. 1:00 Hr./ Min.	12:59 Hr./ Min.
	24 Hr. 0:00 Hr./ Min.	23:59 Hr./ Min.
CLEAN TIME	2 hours	4 hours
CONVECTION BAKE	300°F / 149°C	550°F / 288°C



Setting Oven Controls

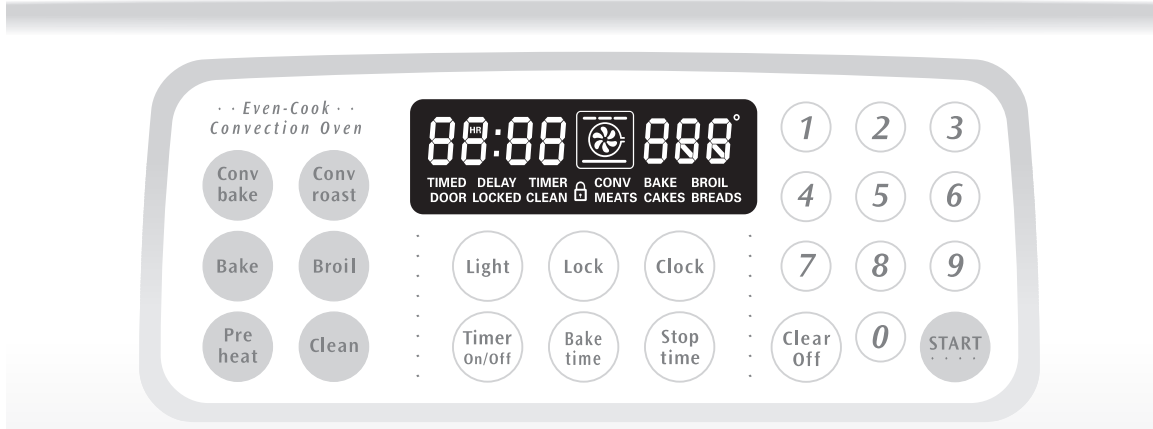

Setting the Clock

The **CLOCK**  pad is used to set the clock. The clock may be set for 12 or 24 hour time of day operation. The clock has been preset at the factory for the 12 hour operation. When the range is first plugged in, or when the power supply to the range has been interrupted, the timer in the display will flash with "PF" (power failure, See Fig. 1).

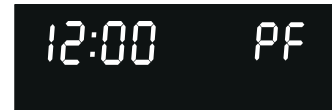







Figure 1

INSTRUCTIONS

To set the clock (example below for 1:30):

1. Press . "CLO" will appear in the display (Fig. 2).
2. Press    pads to set the time of day to 1:30 (Fig. 3).
- 3). "CLO" will appear in the display. Press . "CLO" will disappear and the clock will start (Fig. 4).

PRESS

DISPLAY

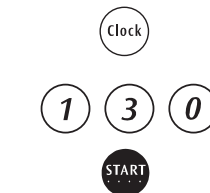





Figure 2



Figure 3

Changing between 12 or 24 hour time of day display:

1. Press and hold  for 6 seconds (Fig. 3). While holding the pad down, the current time of day will remain and "CLO" will disappear from the display (Fig. 4). CONTINUE holding the pad until the a beep is heard.
2. The display will show either "12:00" (Fig. 5) or "24:00" (Fig. 6).
3. Press  to switch between the 12 and 24 hour time of day display. The display will show either "12:00" (Fig. 5) or "24:00" (Fig. 6).
4. Press  to accept the change or press  to reject the change.
5. Reset the correct time as described in **To set the Clock** above. Please note that if the 24 hour time of day mode was chosen, the clock will now display time from 0:00 through 23:59 hours.

 for 6 seconds

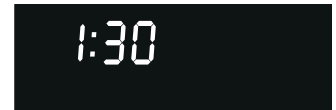

Figure 4

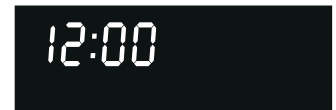

Figure 5





Figure 6

Setting Oven Controls







Setting Continuous Bake or 12 Hour Energy Saving

The **KITCHEN TIMER**  and **CLEAN**  pads control the Continuous Bake or 12 Hour Energy Saving features. The oven control has a factory preset built-in 12 Hour Energy Saving feature that will shut off the oven if the oven control is left on for more than 11 hours and 59 minutes. The oven can be programmed to override this feature for Continuous Baking.

INSTRUCTIONS

To set the control for Continuous Bake or 12 Hour Energy Saving features:

1. Press and hold  for 7 seconds (Fig.1). ":12" or ":- -" will appear in the display and the control will beep once.
2. Press  to switch between the 12 Hour Energy Saving and continuous bake features. Note: ":12" in the display indicates the control is set for the 12 Hour Energy Saving mode and ":- -" indicates the control is set for the Continuous Bake feature (Figures 2 and 3).
3. Press  to accept the change (Fig. 4; display will return to time of day) or press  to reject the change.

PRESS

 for 7 seconds



 or 

DISPLAY



Figure 1



Figure 2



Figure 3

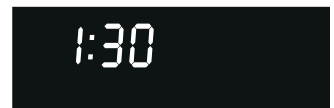







Figure 4

Setting Kitchen Timer

The **KITCHEN TIMER**  pad controls the Kitchen Timer feature. The Kitchen Timer serves as an extra timer in the kitchen that will beep when the set time has run out. It does not start or stop cooking. The Kitchen Timer feature can be used during any of the other oven control functions. Refer to the "Minimum and Maximum Control Pad Settings" on page 15 for the time amount settings.

INSTRUCTIONS

To set the Kitchen Timer (example for 5 minutes):

1. Press . "0:00" will appear and "TIMER" will flash in the display (Fig. 5).
2. Press the number pads to set the desired time in the display (example ). Press . The time will begin to count down (Fig. 6) and "TIMER" will appear in the display. Note: If  is not pressed the timer will return to the time of day.
3. When the set time has run out, "End" will show in the display (Fig. 7), and 3 beeps every 60 seconds will sound until  is pressed.

PRESS





DISPLAY



Figure 5



Figure 6



Figure 7

To cancel the Kitchen Timer before the set time has run out:

Press . The display will return to the time of day.





Setting Oven Controls

Setting Oven Lockout Feature

The **Lock** pad controls the Oven Lockout feature. The Oven Lockout feature automatically locks the oven door and prevents the warmer drawer and ESEC Control from being turned on. It does not disable the clock, Kitchen Timer, Warmer Zone or the interior oven lights.

INSTRUCTIONS

PRESS

DISPLAY

To activate the Oven Lockout feature:

1. Press and hold **Lock** for three seconds (Fig. 1).
2. After 3 seconds the lock icon light () will appear, a beep will sound and "DOOR LOCKED" will flash in the display. Once the oven door is locked the "DOOR LOCKED" indicator will stop flashing and remain on along with the lock icon light.

Lock for 3 seconds

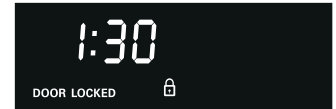



Figure 1

To reactivate normal oven operation:

1. Press and hold **Lock** for three seconds. A beep will sound. The "DOOR LOCKED" will continue to flash until the oven door has completely unlocked and the lock icon light () will clear (See Fig. 2).
2. The range is again fully operational.

Lock for 3 seconds

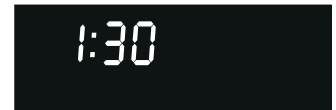

Figure 2

Setting Temperature Display — Fahrenheit or Celsius

The **BROIL** **Broil** and **CLEAN** **Clean** pads control the Fahrenheit or Celsius temperature display modes. The oven control can be programmed to display temperatures in Fahrenheit or Celsius. The oven has been preset at the factory to display in Fahrenheit.

INSTRUCTIONS

PRESS

DISPLAY

To change display from Fahrenheit to Celsius or Celsius to Fahrenheit:

1. To tell if the display is set for Fahrenheit or Celsius press and hold the **Broil** pad. "BROIL", "550°" will appear in the display (See Fig. 3) and continue to HOLD for 7 seconds. A beep will then sound. If "F" appears, the display is set to show temperatures in Fahrenheit (Fig. 4). If "C" appears, the display is set to show temperatures in Celsius (Fig. 5).
2. Press **Clean** to switch between Fahrenheit or Celsius display modes. The display will show either "F" (Fig. 4) or "C" (Fig. 5).
3. Press **START** to accept the change or press **Clear Off** to reject the change.

Broil for 7seconds

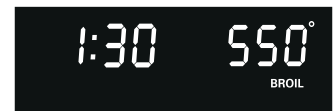

Figure 3

Clean

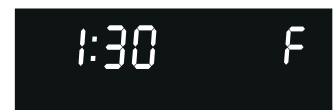

Figure 4

START or **Clear Off**

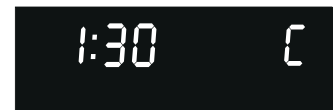
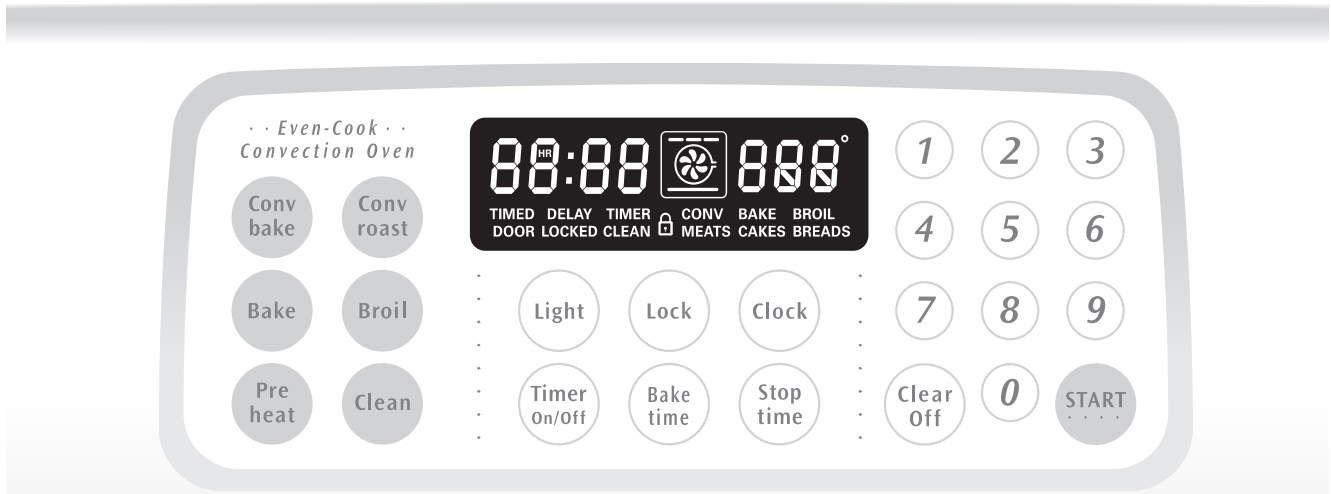

Figure 5

Setting Oven Controls



Setting Silent Control Operation

The **STOP TIME** (Stop time) and **CLEAN** (Clean) pads control the Silent Control operation feature. The Silent Control operation feature allows the oven control to be operated without sounds or beeps whenever necessary. If desired the control can be programmed for silent operation and later returned to operating with all the normal sounds and beeps.

INSTRUCTIONS

To change control from normal sound operation to silent control operation:

- To tell if your range is set for normal or silent operation press and hold (Stop time) for 7 seconds. "DELAY" will appear and flash in the display (Fig. 1). If ":SP" appears (Fig. 2), the control will operate with normal sounds and beeps. If ":-" appears (Fig.3), the control is in the silent operation mode.
- Press (Clean) to switch between normal sound operation and silent operation mode. The display will show either ":SP" (Fig. 2) or ":-" (Fig. 3).
- Press (START) to accept the change or press (Clear off) to reject the change.

PRESS

DISPLAY

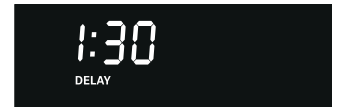

Figure 1

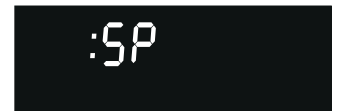

Figure 2



Figure 3

(Stop time) for 7seconds

(Clean)

(START) or (Clear off)







Setting Oven Controls

Setting Preheat

The **PREHEAT**  pad controls the Preheat feature. The Preheat feature will bring the oven up to temperature and then indicate when to place the food in the oven. Use this feature when recipes call for preheating. Preheating is not necessary when roasting or cooking casseroles. The oven can be programmed to preheat at any temperature between 170°F to 550°F.

INSTRUCTIONS

To set the Preheat temperature for 350°F:







1. Arrange the interior oven racks.
2. Press . "---°" and "BAKE" will appear in the display (Fig. 1).
3. Press   . "350°" and "PRE" will appear in the display (Fig. 2).
4. Press . "PRE" and "BAKE" will appear in the display as the oven heats and reaches 350°F (Fig 3).

Note: After the oven has reached the desired temperature (this example, 350°F) the control will beep and the "PRE" light will turn off and oven temperature will be displayed (Fig. 4). If the beep was missed, a quick glance at the display with oven temperature showing in the oven display is a good way to check that the oven has already reached the preheat temperature. Once the oven has preheated, **PLACE FOOD IN THE OVEN**. The "BAKE" light will stay on.

Press  when baking is complete or to cancel the preheat feature.

To change Preheat temperature while oven is preheating (example changing from 350 to 425°F):

If it is necessary to change the preheat temperature while the oven is preheating to the original temperature:

1. While preheating, press . "---°" and "BAKE" will appear in the display (Fig. 5).
2. Enter the new preheat temperature. Press   . "425°" and "BAKE" will appear in the display (Fig. 6).
3. Press . "PRE" and "BAKE" will appear in the display as the oven heats to 425°F (Fig 7). A beep will sound once the oven temperature reaches 425°F and the display will show "425°" and "BAKE".
4. When baking is complete press .

PRESS

DISPLAY

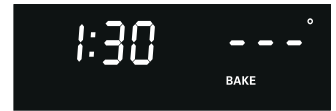

Figure 1

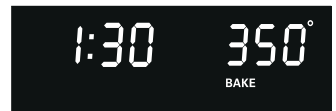

Figure 2



Figure 3



Figure 4



Figure 5



Figure 6



Figure 7





Figure 8

Setting Oven Controls





Setting Bake

The **BAKE**  pad controls normal baking. If preheating is necessary, refer to the **Pre heat**  Preheat Feature for instructions. The oven can be programmed to bake at any temperature from 170°F to 550°F (The sample shown below is for 350°F).

INSTRUCTIONS



To set the Bake Temperature to 350°F:

1. Arrange interior oven racks and place food in oven.
2. Press **Bake** , " - - - ° " will appear in the display (Fig. 1).
3. Press **3** **5** **0** (Fig. 2). "BAKE" will flash and "350°" will appear in the display.
4. Press **START** . "BAKE" and "350°" will appear in the display (See Fig. 3).

Note: A beep will sound once the oven temperature reaches 350° F.

Pressing **Clear off**  will cancel the Bake feature at any time.

To change the Bake Temperature (example changing from 350° to 425°F):

1. After the oven has already been set to bake at 350°F and the oven temperature needs to be changed to 425°F, press **Bake**  (Fig.4) and " - - - ° " will show in the display.
2. Press **4** **2** **5** (Fig. 5). "425°" and "BAKE" will appear in the display.
3. Press **START** . "BAKE" and the new oven temperature "425°" will appear in the display (Fig 6).

PRESS

Bake 

3 **5** **0**

START 

Clear off 

Bake 

4 **2** **5**

START 

DISPLAY

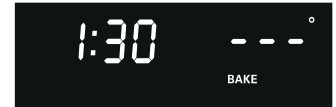

Figure 1

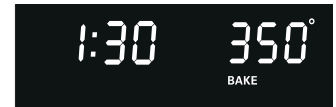

Figure 2



Figure 3



Figure 4



Figure 5





Figure 6











Setting Oven Controls





Setting Timed Bake

The **BAKE**  and **BAKE TIME**  pads control the Timed Bake feature. The automatic timer of the Timed Baked feature will turn the oven **off** at the time you select in advance.

INSTRUCTIONS

To program the oven to begin baking immediately and to shut off automatically: (example below to bake at 350°F for 50 minutes):

1. Be sure the clock is set for the correct time of day.
2. Arrange interior oven rack(s) and place the food in the oven.
3. Press , " --- °" will appear in the display (Fig. 1).
4. Press    (Fig. 2). "BAKE" will flash and "350°" will appear in the display.
5. Press . "BAKE" and "350°" will be displayed (See Fig. 3).
6. Press . "TIMED" will flash; "BAKE", "0:00" and "350°" will appear in the display (Fig.4).
7. Enter the desired baking time by pressing  . "TIMED" will flash and "BAKE", ":50" and "350°" will appear in the display (Fig. 5). Note: Baking time can be set for any amount of time between 1 minute to 11 hours and 59 minutes.
8. Press . Both the "TIMED" and "BAKE" icons will remain on in the display (Fig. 6). Once the Timed Bake feature has started, the current time of day will appear in the display.

Note: After the Timed Bake feature has activated, press  to display the bake time remaining in the Timed Bake mode. Once Timed Bake has started baking, a beep will sound when the oven temperature reaches the set temperature. The **BAKE TIME**  pad may also be used to set timed or delayed timed cooking with the **CONV ROAST**  or **CONV BAKE**  pads.

Press  when baking is complete or at any time to cancel the Timed Bake feature.

When the timed bake time runs out:

1. "End" will appear in the display and the oven will shut off automatically (Fig. 7).
2. The control will beep 4 times. The control will continue to beep 3 times each minute until  is pressed.

PRESS

DISPLAY

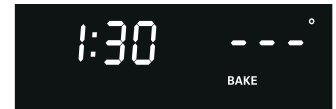

Figure 1

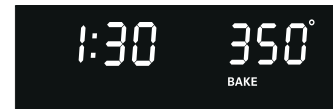

Figure 2



Figure 3



Figure 4



Figure 5



Figure 6



Figure 7

CAUTION Use caution with the **TIMED BAKE** or **DELAYED TIME BAKE** features. Use the automatic timer when cooking cured or frozen meats and most fruits and vegetables. Foods that can easily spoil such as milk, eggs, fish, meat or poultry, should be chilled in the refrigerator first. Even when chilled, they should not stand in the oven for more than 1 hour before cooking begins, and should be removed promptly when cooking is completed. Eating spoiled food can result in sickness from food poisoning.

Setting Oven Controls



















Setting Delayed Time Bake

The **BAKE** , **BAKE TIME**  and **STOP TIME**  pads control the Delayed Time Bake feature. The automatic timer of the Delayed Time Bake will turn the oven **on and off** at the time you select in advance.

INSTRUCTIONS

To program the oven for a delayed bake start time and to shut off automatically (example for baking at 350°F for 50 minutes and finishing at 5:30):

1. Be sure that the clock is set with the correct time of day.
2. Arrange interior oven rack(s) and place the food in the oven.
3. Press . "---°" will appear in the display (Fig. 1).
4. Press    (Fig. 2). "BAKE" will flash and "350°" will appear in the display.
5. Press . "BAKE" and "350°" will appear in the display (Fig. 3).
6. Press . "TIMED" will flash; "BAKE", "0:00" and "350°" will appear in the display (Fig.4).
7. Enter the desired baking time using the number pads by pressing  . "TIMED" will flash; "BAKE", ":50" and "350°" will appear in the display (Fig. 5). Note: Baking time can be set for any amount of time from 1 minute to 11 hours and 59 minutes.
8. Press . "TIMED", "BAKE" and "350°" will be displayed (Fig. 6).
9. Press . Enter the desired stop time using the number pads    (Fig. 7).
10. Press . When Delayed Time Bake starts, the set oven temperature will disappear, "TIMED DELAY", "BAKE" and the current time of time of day will appear in the display (Fig. 8).

Note: Once Delayed Time Bake has started, press  to display the bake time remaining . Once Delayed Time Bake has started baking, a beep will sound when the oven temperature reaches the set temperature. Press  when baking has completed or at any time to cancel the Delayed Time Bake feature.

When the set bake time runs out:

1. "End" will appear in the display and the oven will shut off automatically (Fig. 9).
2. The control will beep 4 times. The control will continue to beep 3 times each minute until  is pressed.

PRESS

DISPLAY

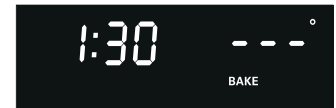
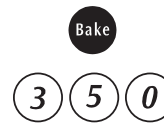

Figure 1



Figure 2



Figure 3



Figure 4

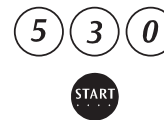

Figure 5



Figure 6



Figure 7



Figure 8



Figure 9



Setting Oven Controls

Setting Broil (for Gas Ranges) - The **Broil** pad controls the Broil feature. When broiling, heat radiates downward from the oven burner broiler for even coverage. The Broil feature is preset to start broiling at 550°F however, the Broil feature temperature may be set between 400°F and 550°F.

The broil pan and broil pan insert used together allow dripping grease to drain and be kept away from the high heat of the oven broiler. **DO NOT** use the broil pan without the insert (See Fig. 4). **DO NOT cover the broil pan insert with foil.** The exposed grease could catch fire.

WARNING Should an oven fire occur, leave the oven door closed and turn off the oven. If the fire continues, throw baking soda on the fire or use a fire extinguisher. **DO NOT** put water or flour on the fire. Flour may be explosive and water can cause a grease fire to spread and cause personal injury.

INSTRUCTIONS

To set the oven to broil at the default setting (550°F):

1. Place the broiler pan insert on the broiler pan. Then place the food on the broiler pan insert. **DO NOT** use the broiler pan without the insert. **DO NOT** cover the broiler insert with foil. The exposed grease could ignite.
2. Arrange the interior oven rack and place the broiler pan on the rack. Be sure to center the broiler pan directly under the broiler burner. **Close the oven door.**
3. Press **Broil**. "BROIL" will flash and "550°" will appear (Fig. 1).
4. If a lower broil temperature is desired (minimum broil temperature setting is 400°F), press the desired temperature before continuing to step 5.
5. Press **START**. The oven will begin to broil. "BROIL" and "550°" will appear in the display (Fig. 2).
6. Broil on one side until food is browned; turn and cook on the second side. Season and serve. **Note:** Always pull the rack out to the stop position before turning or removing food.
7. To cancel broiling or if finished broiling press **Clear off** (Fig. 3).

PRESS

DISPLAY

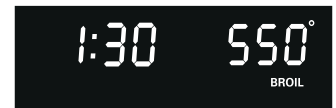

Figure 1



Figure 2

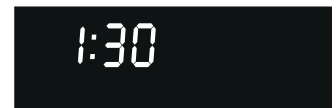

Figure 3



Broiling Times

Use the following table for approximate broiling times. Increase or decrease broiling times, or move the broiling pan to a different rack position to suit for doneness. If the food you are broiling is not listed in the table, follow the instructions provided in your cookbook and watch the item closely.

Gas Range Broiling Table Recommendations

Food Item	Rack Position	Temp Setting	Cook Time		Doneness
			1st side	2nd side	
Steak 1" thick	2nd	550° F	8:00	6:00	Rare
	2nd	550° F	10:00	8:00	Medium
Pork Chops 3/4" thick	2nd	550° F	12:00	8:00	Well
Chicken - Bone In	3rd	450° F	25:00	15:00	Well
Chicken - Boneless	2nd	450° F	10:00	8:00	Well
Fish	2nd	500° F	as directed	as directed	Well
Shrimp	3rd	550° F	as directed	as directed	Well
Hamburger 3/4" thick	2nd	550° F	12:00	10:00	Medium
	3rd	550° F	14:00	12:00	Well

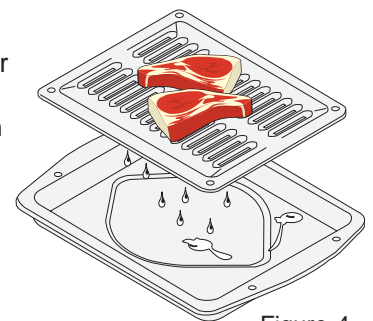



Figure 4

Setting Oven Controls







Setting Convection Roast

The **CONV ROAST**  pad feature is used when cooking with meat. This pad has been designed to give optimum cook performance for roasting meats.

The CONVECTION ROAST pad combines a cook cycle with the convection fan and element to roast meats and poultry. Preheating is not necessary for meats and poultry. Heated air circulates around the food from all sides, sealing in juices and flavors. Foods are crispy brown on the outside while staying moist on the inside.

INSTRUCTIONS

To set the Convection Roast feature (example for Convection Roast at 350°F):

1. Arrange interior oven racks and place food in oven.
2. Press . "CONV" will flash and "---°" will be displayed (See Fig. 1).
3. Press   . "CONV" will flash and "350°" will appear in the display (See Fig. 2).
4. Press . "CONV" and "350°" will appear in the display (See Fig. 3). The convection fan icon will come on a few minutes after setting the Convection Roast feature (See Fig. 4).

Press  to stop Convection Roast, or to cancel Convection Roast at any time.

Convection Roasting Instructions

When using the Convection Roast pad, use the broiler pan and insert along with the roasting rack. The broiler pan will catch grease spills and the insert will help prevent grease splatters. The roasting rack will allow the heat to circulate around the meat.

CAUTION To prevent food from contacting the broil element and to prevent grease splattering, **DO NOT** use the roasting rack when broiling.

1. Place oven rack on bottom or next to the bottom rack position. See **Arranging Oven Racks** in this Use & Care Manual.
2. Place the insert in the broiler pan. The roasting rack fits on the insert allowing the heated air to circulate under the food for even cooking and helps to increase browning on the underside. Make sure the roasting rack is securely seated on the insert in the broiler pan. **DO NOT** use the broiler pan without the insert or cover the insert with aluminum foil.
3. Position food (fat side up) on the roasting rack (See Fig. 4).
4. Place the broiler pan on the oven rack.

Note: The **BAKE TIME**  pad may be used to set timed or delayed timed cooking with

the **CONV ROAST**  pad (refer to page 20, steps 6-8).

PRESS



DISPLAY



Figure 1



Figure 2



Figure 3



Figure 4

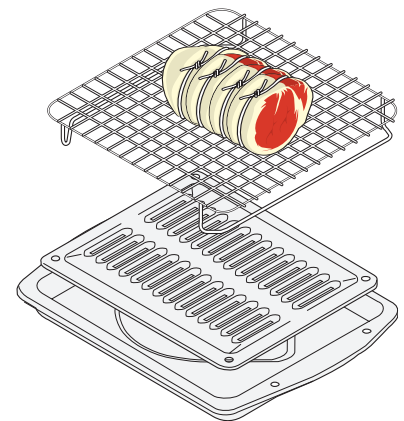



Figure 4



Setting Oven Controls

Setting Convection Bake

The **CONV BAKE**  pad controls the Convection Bake feature. Use the Convection Bake feature when cooking speed is desired. The oven can be programmed for Convection baking at any temperature between 300°F (149° C) to 550°F (288° C).

Benefits of Convection Bake:

- Some foods cook up to 30% faster, saving time and energy.
- Multiple rack baking.
- No special pans or bakeware needed.

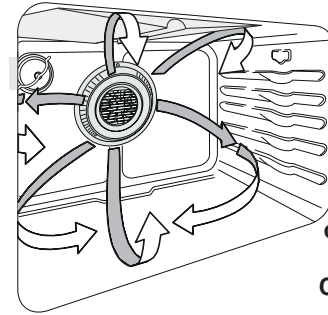

Air circulation during Convection Bake

Figure 1

Convection baking uses a fan to circulate the oven's heat evenly and continuously within the oven (See Figure 1). This improved heat distribution allows for fast, even cooking and browning results. It also gives better baking results when using two (2) or three (3) racks at the same time. Breads and pastries brown more evenly. Most foods cooked in a standard oven will cook faster and more evenly with Convection Bake.

Note: The **BAKE TIME**  pad may be used to set timed or delayed timed cooking with the **CONV BAKE**  pad (refer to page 20 steps 6-8).

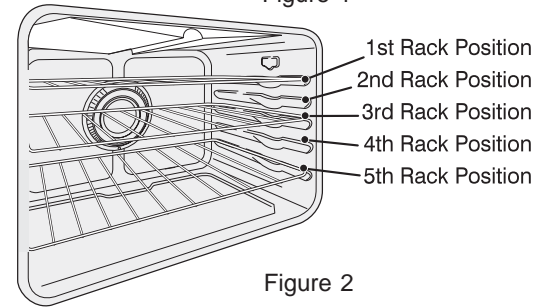







Figure 2

General Convection Bake Instructions

1. When using Convection Bake, decrease your normal cooking times as shown on page 34. Adjust the cook time for desired doneness as needed. Time reductions will vary depending on the amount and type of food to be cooked. Cookies and biscuits should be baked on pans with no sides or very low sides to allow heated air to circulate around the food. Food baked on pans with a dark finish will cook faster.
2. Preheating is not necessary when cooking casseroles with Convection Bake.
3. When using Convection Bake with a single rack, place oven rack in position 3 or 4. If cooking on multiple racks, place the oven racks in positions 1, 3 and 5 (for 3 racks) and positions 2 and 4 (for 2 racks; See Fig. 2).
4. **Layer cakes** will have better results when baked with the normal Bake feature.

INSTRUCTIONS

To set the oven for Convection Bake and temperature to 350°F:

1. Arrange interior oven racks and place food in oven.
2. Press . "**CONV BAKE**" will flash and "- - -°" will appear in the display (Fig. 3).
3. Press   . "**CONV BAKE**" and "**350°**" will appear in the display.
4. Press . "**CONV BAKE**" and "**PRE**" will appear in the display (Fig. 5) until the oven reaches 350°F. A beep will sound once the oven temperature reaches 350°F and the display will show "**350°**", "**CONV BAKE**" and the fan icon (Fig. 6).

Note: The convection fan will come on a short time AFTER the oven has been set for Convection Bake. The oven icon display will then show a rotating fan. This rotating fan icon indicates when the Convection Fan is operating (See Fig. 6).

Press  to stop Convection Bake or cancel Convection Bake at any time.

PRESS

DISPLAY



Figure 3

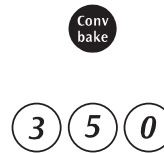

Figure 4

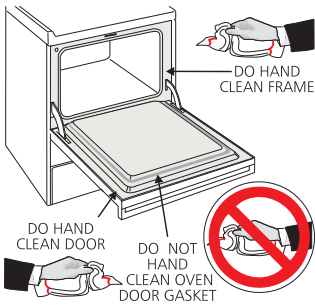

Figure 5



Figure 6





CAUTION The health of some birds is extremely sensitive to the fumes given off during the self-cleaning cycle of any range. Move birds to another well-ventilated room.

Preparing for the Self-Clean Cycle

A self-cleaning oven cleans itself with high temperatures which eliminate soil completely or reduce it to a fine powdered ash you can wipe away with a damp cloth. These temperatures are well above normal cooking temperatures.

1. Adhere to the following cleaning precautions:

- Allow the oven to cool before pre-cleaning.
- Wear rubber gloves when pre-cleaning and while wiping up the residue after the self-clean cycle.
- **DO NOT** use oven cleaners or oven protective coatings in or around any part of the self-cleaning oven.
- **DO NOT** clean the oven door gasket. The woven material of the oven door gasket is essential for a good seal. Care should be taken not to rub, damage or remove the gasket.
- **DO NOT** use any cleaning materials on the oven door gasket. Doing so could cause damage.

2. Remove the searing grill, broiler pan and broiler pan insert, all utensils and any aluminum foil. These items cannot withstand high cleaning temperatures.

CAUTION **DO NOT** line the oven walls, racks, bottom or any other part of the range with aluminum foil. Doing so will destroy heat distribution, produce poor baking results and cause permanent damage to the oven interior (aluminum foil will melt to the interior surface of the oven).

3. Oven racks should be removed, or else their finish will dull and their color turn slightly blue. If they do go through the self-clean cycle, wait until the oven has cooled, then remove the racks and rub their sides with wax paper or a cloth containing a small amount of baby or salad oil (this will make the racks glide easier back into their positions).
4. Remove any excess spillovers in the oven cavity before starting the self-cleaning cycle. To clean, use hot, soapy water and a cloth. Large spillovers can cause heavy smoke or fire when subjected to high temperatures. **DO NOT** allow food spills with a high sugar or acid content (such as milk, tomatoes, sauerkraut, fruit juices or pie filling) to remain on the surface as they may cause a dull spot even after cleaning.
5. Clean any soil from the oven frame, the door liner outside the oven door gasket, and the small area at the front center of the oven bottom. These areas heat sufficiently to burn soil on. Clean with soap and water.

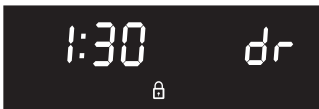

Figure 1

If at any time when setting the oven for the Self-Cleaning feature, the oven control continuously beeps and the display shows “dr”; close the oven door (See Figure 1).

NOTE: Prior to setting the Self-Clean cycle, any spills remaining on the oven bottom should be removed.



Self-Cleaning

To Start Self-Clean Cycle

The **CLEAN**  pad controls the Self-Cleaning feature. If you are planning to use the oven directly after a self-clean cycle remember to allow time for the oven to cool down and the oven door to unlock. This normally takes about one hour. So to self-clean for 3 hours will actually take about 4 hours to complete.





*It is recommend to use a 2 hour self-clean cycle for **light soils**, a 3 hour cycle for **average soils**, and a 4 hour cycle for **heavy soils** (to assure satisfactory results).

WARNING During the self-cleaning cycle, the outside of the range can become very hot to the touch. **DO NOT** leave small children unattended near the appliance; they may be burned if they touch the hot oven door surfaces.

CAUTION **DO NOT** force the oven door open. This can damage the automatic door locking system. Use care when opening the oven door after the self-cleaning cycle. Stand to the side of the oven when opening the door to allow hot air or steam to escape. The oven may still be **VERY HOT**.

INSTRUCTIONS

To set the controls for a 3 hour Self-Cleaning cycle to start immediately and shut off automatically:

1. Be sure the clock is set with the correct time of day and the oven door is closed.
2. Press . "CLEAN" will flash and "3:00" will show in the display (Fig. 1). The control will automatically clean for a 3 hour period (default self-cleaning cycle time). Note: If a 2 or 4 hour clean time is desired, press  for 2 hour or press  for a 4 hour clean time. Set the cleaning time based on the amount of soil you have; light, medium or heavy (*See above).
3. Press . The "DOOR LOCKED" icon will flash; "CLEAN" icon and the letters "CLn" will remain on in the display (Fig. 2).
4. As soon as the control is set, the motor driven oven door lock will begin to close automatically. Once the door has been locked the "DOOR LOCKED" indicator light will stop flashing and remain on. Also, the oven icon will appear in the display (Fig. 3).

Note: Allow about 15 seconds for the oven door lock to close.

When the Self-Clean Cycle has completed:

1. The time of day, the "DOOR LOCKED" and "CLEAN" icon will remain in the display (Fig. 4).
2. Once the oven has cooled down for approximately 1 HOUR, and the "DOOR LOCKED" icon is no longer displayed, the oven door can then be opened (Fig. 5).

Stopping or Interrupting a Self-Cleaning Cycle:

If it becomes necessary to stop or interrupt a self-cleaning cycle due to excessive smoke or fire in the oven:

1. Press .
2. Once the oven has cooled down for approximately 1 HOUR and the "DOOR LOCKED" icon is no longer displayed, the oven door can then be opened (Fig. 5).

PRESS

DISPLAY



Figure 1

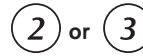

Figure 2



Figure 3



Figure 4

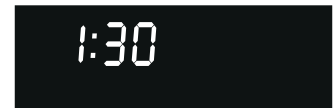



Figure 5



Self-Cleaning

Clean

To Start Delayed Self-Clean Cycle









The **CLEAN** , **STOP TIME**  pads and length of clean cycle, controls the Delayed Self-Clean operation. The automatic timer will turn the oven **on and off** at the time you select in advance. Be sure to review TO START THE SELF-CLEAN CYCLE for recommended clean times.

WARNING During the self-cleaning cycle, the outside of the range can become very hot to the touch. **DO NOT** leave small children unattended near the appliance.

CAUTION **DO NOT** force the oven door open. This can damage the automatic door locking system. Use care when opening the oven door after the self-cleaning cycle. Stand to the side of the oven when opening the door to allow hot air or steam to escape. The oven may still be VERY HOT.

INSTRUCTIONS

To set the control for the Self-Cleaning Cycle to start at a delayed time and shut off automatically: (example 3 hour self-clean cycle to finish at 9:00):

1. Be sure the clock is set with the correct time of day and the oven door is closed.
2. Press . "CLEAN" will flash and "3:00" will show in the display (Fig. 1). The control will automatically clean for a 3 hour period (default self-cleaning cycle time). Note: If a 2 or 4 hour clean time is desired, press  for 2 hour or press  for a 4 hour clean time. Set the cleaning time based on the amount of soil you have; light, medium or heavy (*See page 26).
3. Press . The "DOOR LOCKED" icon will flash; "CLEAN" icon and the letters "CLn" will remain on in the display (Fig. 2).
4. Press  (Fig. 3). Enter the desired stop time using the number pads    (Fig. 4).
5. Press . The "CLn" icon will turn off; "DELAY", "DOOR LOCKED" and "CLEAN" icons will remain on.
6. As soon as the control is set, the motor driven oven door lock will begin to close automatically and once the door has been locked the "DOOR LOCKED" indicator light will quit flashing and remain on. The oven icon will appear in the display (Fig. 5).
7. The control will calculate backward from the set stop time to determine when the self-cleaning cycle should begin. The self-cleaning cycle will come on automatically at the calculated time. At that time, the icon "DELAY" will go out; "CLEAN" and "CLn" will appear in the display (Fig. 6).







When the Self-Clean Cycle has completed:

1. The time of day, the "DOOR LOCKED" and "CLEAN" icon will remain in the display (Fig. 7).
2. Once the oven has cooled down for approximately 1 HOUR, and the "DOOR LOCKED" icon is no longer displayed, the oven door can then be opened (Fig. 8).

PRESS

DISPLAY

The diagram illustrates the sequence of button presses and corresponding display changes:

- Figure 1:** Press . Display shows 3:00.
- Figure 2:** Press . Display shows 1:30 CLn. (Note: The diagram shows the Clean button being pressed again, which is likely a typo in the original document for the Start button).
- Figure 3:** Press . Display shows 4:30 CLn.
- Figure 4:** Press number pads   . Display shows 9:00 CLn.
- Figure 5:** Press . Display shows 1:30. (Note: The diagram shows the Start button being pressed again, which is likely a typo in the original document for the Clean button).
- Figure 6:** The display shows 1:30 CLn.
- Figure 7:** The display shows 1:30 CLn.
- Figure 8:** The display shows 1:30.



Self-Cleaning

To Start the Delayed Self-Clean Cycle (cont'd)

INSTRUCTIONS

PRESS

DISPLAY

Stopping or Interrupting a Self-Cleaning Cycle

If it becomes necessary to stop or interrupt a self-cleaning cycle due to excessive smoke or fire in the oven:

1. Press .
2. Once the oven has cooled down for approximately 1 HOUR and the "DOOR LOCKED" icon is no longer displayed, the oven door can then be opened (Fig. 2-1).



Figure 2-1



Adjusting Oven Temperature

The temperature in the oven has been pre-set at the factory. When first using the oven, be sure to follow recipe times and temperatures. If you think the oven is too hot or too cool, the temperature in the oven can be adjusted. Before adjusting, test a recipe by using a temperature setting that is higher or lower than the recommended temperature. The baking results should help you to decide how much of an adjustment is needed.

Note: The oven temperature adjustments made with this feature will not change the Self-Clean cycle temperature.

INSTRUCTIONS

PRESS

DISPLAY

To adjust the oven temperature higher:





1. Press  for 6 seconds (Fig. 1).
2. To increase the temperature use the number pads to enter the desired change. (Example 30°F)   (Fig. 2). The temperature may be increased as much as 35°F (17°C).
3. Press  to accept the temperature change and the display will return to the time of day (Fig. 3). Press  to reject the change if necessary.



Figure 1



Figure 2

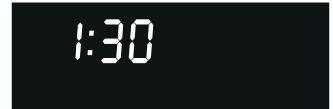

Figure 3

To adjust the oven temperature lower:







1. Press  for 6 seconds (Fig. 4).
2. To decrease the temperature use the number pads to enter the desired change. (Example -30°F)   and then press  (Fig. 5). The temperature may be decreased as much as 35°F (17°C).
3. Press  to accept the temperature change and the display will return to the time of day (Fig. 6). Press  to reject the change if necessary.



Figure 4



Figure 5

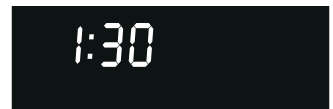

Figure 6

Care & Cleaning

(Cleaning Chart)



Surfaces

How to Clean

Aluminum & Vinyl

Use hot, soapy water and a cloth. Dry with a clean cloth.

Painted and Plastic Control Knobs, Body Parts, and Decorative Trim

For general cleaning, use hot, soapy water and a cloth. *For more difficult soils and built-up grease*, apply a liquid detergent directly onto the soil. Leave on soil for 30 to 60 minutes. Rinse with a damp cloth and dry. **DO NOT** use abrasive cleaners on any of these materials; they can scratch. To remove control knobs, turn to the OFF position; grasp firmly and pull straight off the shaft. To replace knobs after cleaning, line up the flat sides of both the knob and the shaft; then push the knob into place.

Before cleaning the control panel, turn all controls to OFF and remove the control knobs. To remove, pull each knob straight off the shaft. Clean using hot, soapy water and a dishcloth. Rinse with a clean water using a dishcloth. Be sure to squeeze excess water from the cloth before wiping the panel; especially when wiping around the controls. Excess water in or around the controls may cause damage to the appliance. To replace knobs after cleaning, line up the flat sides of both the knob and the shaft; then push the knob into place.

Stainless Steel, Chrome Control Panel, Decorative Trim

Clean **stainless steel** with hot, soapy water and a dishcloth. Rinse with clean water and a cloth. **Do not use cleaners with high concentrations of chlorides or chlorines.** Do not use harsh scrubbing cleaners. Only use kitchen cleaners that are especially made for cleaning stainless steel. Always be sure to rinse the cleaners from the surface as bluish stains may occur during heating that cannot be removed.

Porcelain Enamel Broiler Pan and Insert, Door Liner, Body Parts, Warmer Drawer (for Burner Caps, Burner Heads and Grates see page 30).

Gentle scouring with a soapy scouring pad will remove most spots. Rinse with a 1:1 solution of clear water and ammonia. *If necessary*, cover difficult spots with an ammonia-soaked paper towel for 30 to 40 minutes. Rinse with clean water and a damp cloth, and then scrub with a soap-filled scouring pad. Rinse and wipe dry with a clean cloth. Remove all cleaners or the porcelain may become damaged during future heating. **DO NOT** use spray oven cleaners on the cooktop.

Oven Racks

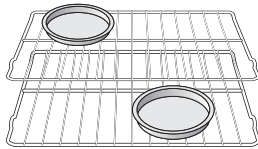

Oven racks should be removed from the oven during the Self-Clean cycle for cleaning. When removed, clean by using a mild, abrasive cleaner following manufacturer's instructions. Rinse with clean water and dry.

If the racks are cleaned in the Self-Clean cycle, their color will turn slightly blue and the finish will be dull. After the Self-Clean cycle is complete, and the oven has cooled, rub the sides of the racks with wax paper or a cloth containing a small amount of baby oil or salad oil (this will make the racks glide easier into the rack positions).

Oven door

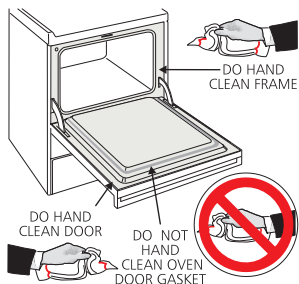

To clean oven door, wash with hot, soapy water and a clean cloth. **DO NOT** immerse the door in water.

DO NOT clean the oven door gasket. The oven door gasket is made of a woven material, on self cleaning models, which is essential for a good seal. Care should be taken not to rub, damage or remove the gasket.



Care & Cleaning

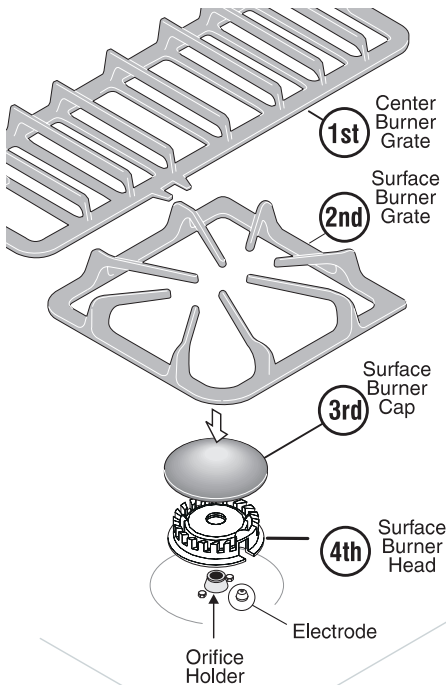

Figure 1

Cleaning the Burner Grates, Burner Caps and Burner Heads

The Burner Grates, Burner Caps and Burner Heads should be routinely cleaned. Keeping the burner ports clean will prevent improper ignition and an uneven flame at each burner position. Refer to the following instructions.

To Remove and Replace the Surface Burner Grate, Surface Burner Cap and Surface Burner Head - Remove in the following order; (1st) Center Burner Grate, (2nd) Surface Burner Grate, (3rd) Surface Burner Cap, (4th) Surface Burner Head (See Fig. 1).

Reverse the procedure above to replace the Surface Burner Cap, Surface Burner Head and Surface Burner Grate. **Do not remove any burner parts from the cooktop until the burner parts have completely cooled and are safe to handle. Do not operate the surface burners without the Surface Burner Caps, Surface Burner Heads and Surface Burner Grates properly in place.**

To Clean the Burner Caps, Burner Heads and Burner Grates - Use a soap-filled scouring pad or a mild abrasive cleanser to clean the surface burner caps and surface burner heads. The ports (or slots) around the burner heads must be routinely cleaned. If residue still remains in these ports, use a small-gauge wire or needle to clean the slots or holes. For proper flow of gas and ignition of the burner—**DO NOT ALLOW SPILLS, FOOD, CLEANING AGENTS OR ANY OTHER MATERIAL TO ENTER THE GAS ORIFICE HOLDER OPENING. ALWAYS** keep the surface burner cap and surface burner head in place whenever a surface burner is in use.

Removing and Replacing the Warming Drawer (some models)

To Remove Warming Drawer:

1. **CAUTION** Turn power off before removing the warmer drawer.
2. Open the drawer to the fully opened position.
3. Locate glide lever on each side of drawer, pull up on the left glide lever and push down on the right glide lever (See Fig. 2).
5. Pull the Warming Drawer away from the range.

To Replace Warming Drawer:

1. **Pull the bearing glides to the front** of the chassis glide (See Fig. 3).
2. Align the glide on each side of the drawer with the glide slots on the range.
3. Push the drawer into the range until levers “click” (approximately 2”). Pull the drawer open again to seat bearing glides into position. **If you do not hear the levers “click” or the bearing glides do not feel seated remove the drawer and repeat steps 1 thru 3.** This will minimize possible damage to the bearing glides.

NOTE: The Warming Drawer will **NOT** operate while in the “Self-Clean” and “Oven Lockout” modes.

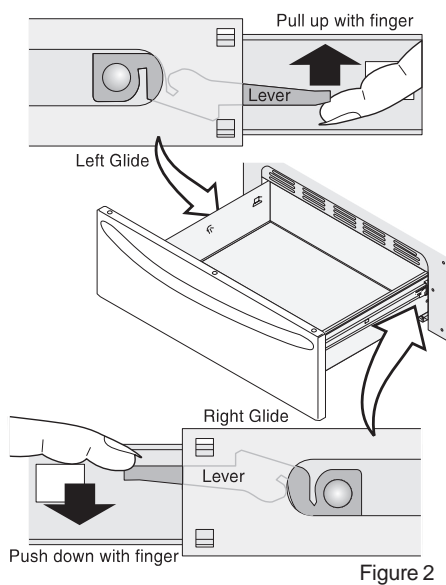

Figure 2

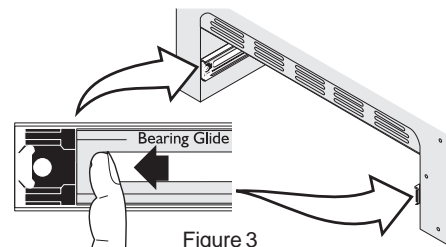

Figure 3



WARNING Electrical Shock Hazard can occur and result in serious injury or death. Disconnect appliance from electric power before cleaning and servicing the warmer drawer.

Care & Cleaning of Stainless Steel (some models)

Some models are equipped with stainless steel exterior parts. Special care and cleaning are **required** for maintaining the appearance of stainless parts. Please refer to the Cleaning Chart provided at the beginning of the **Care & Cleaning** section in this Use & Care Manual.

Care & Cleaning



Operating and Replacing the Oven Light

The interior oven light will automatically turn on when the oven door is opened. Press  to turn the light ON and OFF when the oven door is closed. The oven light is located at the rear wall of the oven interior and is covered with a glass shield held by a wire holder. The glass shield must be in place whenever the oven is in use.

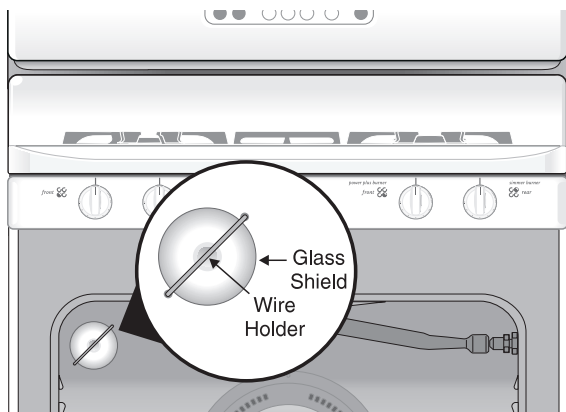

Figure 1

CAUTION Be sure the range is unplugged and all parts are COOL before replacing the oven light. Wear a leather-faced glove for protection against possible broken glass.

To Replace the Oven Light:

1. Turn electrical power off at the main source and unplug the range.
2. Press wire holder to one side to release glass shield (See Fig. 1).
3. Replace the old bulb with a new 40 watt appliance bulb.
4. Replace glass shield over bulb and snap wire holder into place.
5. Turn power back on again at the main source (or plug in the range).
6. The clock will then need to be reset. To reset, see **Setting the Clock** in this Use & Care Manual.

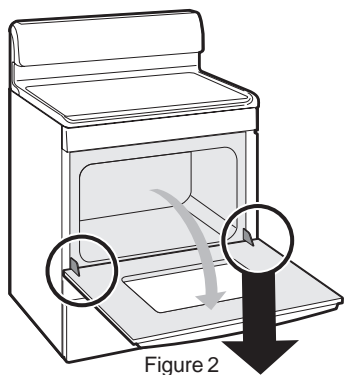

Figure 2

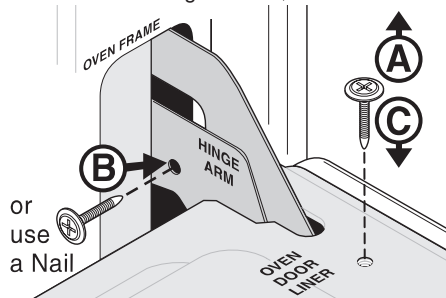

Figure 3

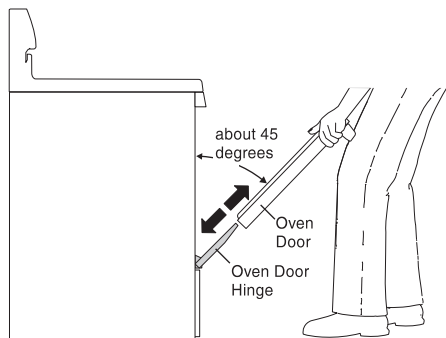

Figure 4

Removing and Replacing the Oven Door (all models)

CAUTION The door is heavy. For safe, temporary storage, lay the door flat with the inside of the door facing down.

To Remove Oven Door:

1. Open oven door completely (horizontal with floor - See Fig. 2).
2. Remove 2 screws located on the inside of the oven door liner (See **A** Fig. 3).
3. Insert the 2 screws into the door hinge holes located on the side of the hinge arm, one into each hinge (See **B** Fig. 3).
4. Close oven door until the door stops, (Do not force the door to close any further). The placement of these screws should keep door open in about a 45 degree position.
5. Grasp oven door firmly on both sides and slide door up and off hinges at the same angle. (See Fig. 4)
6. To clean oven door, follow the instructions provided in the Cleaning Chart at the beginning of the **Care & Cleaning** section (See Door Liner).

To Replace Oven Door:

1. Be sure the hinge arms remain at the 45 degree angle position. Be sure the screws are still locking the hinge arms from moving. If the screws fall out of the hinge holes, the hinge(s) may snap back against the oven frame and could pinch fingers or chip the porcelain finish on the oven front frame.
2. Hold door at the sides near the top while resting the lower front of door on your knee. Insert the door channels at the bottom of door over the door hinges, (See Fig. 4).
3. Allow the door to slide down into the door hinges evenly at the same 45 degree angle. The hinge arms should be inserted into the bottom corners as far as they can go.
4. Open door completely (horizontal with floor) and remove both screws from holes in door hinges.
5. Reinstall the 2 screws into the door liner (See **C** Fig. 3).
6. If the door is not in alignment with the oven frame, remove door and repeat the above steps.



Before You Call

Solutions to Common Problems

Before you call for service, review this list. It may save you time and expense. The list includes common occurrences that are not the result of defective workmanship or materials in this appliance.

OCCURRENCE	POSSIBLE CAUSE / SOLUTION
Range is not level.	<p>Poor installation. Place oven rack in center of oven. Place a level on the oven rack. Adjust leveling legs at base of range until the rack is level. When range is level, cooktop may appear out of alignment if countertop is not level. See the Range Installation Instructions.</p> <p>Weak, unstable floor. Be sure floor is level and can adequately support range. Contact a carpenter to correct sagging or sloping floor.</p> <p>Kitchen cabinet misalignment may make range appear to be unlevel. Be sure cabinets are square and have sufficient room for range clearance.</p>
Cannot move appliance easily. Appliance must be accessible for service.	<p>Cabinets not square or are built in too tight. Contact a cabinet maker to correct the problem.</p> <p>Contact builder or installer to make appliance accessible.</p> <p>Carpeting interferes with range. Provide sufficient space so range can be lifted over carpet.</p> <p>Gas line is hard-plumbed. Have a flexible C.S.A. International approved metal appliance connector installed.</p>
Surface burners do not light.	<p>Surface Control knob has not been completely turned to LITE. Push in and turn the Surface Control knob to LITE until burner ignites and then turn control knob to desired flame size.</p> <p>Burner ports are clogged. With the burner off, use a small-gauge wire or needle to clean ports. See page 30 in the Care & Cleaning Section for additional cleaning instructions.</p> <p>Range power cord is disconnected from outlet (electric ignition models only). Be sure cord is securely plugged into the outlet.</p> <p>Electrical power outage (electric ignition models only).</p>
Surface burner flame burns half way around.	<p>Burner ports are clogged. With the burner off, clean ports by using a small-gauge wire or needle.</p> <p>Moisture is present after cleaning. Lightly fan the flame and allow burner to operate until flame is full. Dry the burners thoroughly and follow the instructions in the Care & Cleaning section on page 30.</p>
Surface burner flame is orange.	<p>Dust particles in main line. Allow the burner to operate a few minutes until flame turns blue.</p> <p>In coastal areas, a slightly orange flame is unavoidable due to salt air.</p>
Oven does not operate.	<p>Be sure the oven controls are set correctly for the desired function. See Setting Oven Controls or "Entire Appliance Does Not Operate" below.</p> <p>Be sure regulator gas valve is "ON". See the Range Installation Instructions.</p> <p>The time of day must first be set on the clock in order to operate the oven.</p>
Entire appliance does not operate.	<p>Make sure electrical cord/plug is plugged tightly into outlet.</p> <p>Service wiring is not complete. Contact a Service.</p> <p>Electrical power outage (electric ignition models only). Check house lights to be sure. Call your local electric company for service.</p> <p>Be sure gas supply is turned on.</p>
Oven light does not work.	<p>Burned-out or loose bulb. See "Changing Oven Light" in the Care & Cleaning section in this Use & Care Guide to replace or tighten the bulb.</p> <p>Electrical power outage. Check house lights to be sure. Call your local electric company for service.</p>

Before You Call

Solutions to Common Problems (cont'd)



OCCURRENCE	POSSIBLE CAUSE / SOLUTION
Oven smokes excessively during broiling.	<p>Meat is too close to the broil burner. Reposition the rack to provide more clearance between the meat and the oven broiler.</p> <p>Meat is not properly prepared. Remove excess fat from meat. Remove remaining fatty edges to prevent the meat from curling, but do not cut into the lean of the meat.</p> <p>Broiler pan used without the broiler pan insert or insert is covered with foil. DO NOT use the broiler pan without the broiler pan insert or cover the insert with foil.</p> <p>Broiler pan or insert needs to be cleaned. Excessive smoking is caused by a build-up of grease or food spatters. If the broiler pan and insert is used often, clean on a regular basis.</p> <p>Oven door is open. Oven door should be closed when broiling.</p>
Oven electronic control beeps and displays F1, F3 or F9.	<p>This oven is equipped with a state of the art electronic oven controller. Among the many features is a full time oven circuit diagnostics system. The controller constantly monitors the internal circuitry as well as several crucial oven circuits to insure they are all operating correctly. If at any time one of these systems fails, the controller will immediately stop the current operation and beep continuously (flashing an error code of F1, F3 or F9 in the controller display window).</p> <p>Electronic control has detected a fault condition. Press CLEAR/OFF to clear the display and stop beeping. Reprogram oven. If fault remains, record fault number. Press CLEAR/OFF and contact a Service.</p>
Oven control beeps when you try to enter times or temperatures	<p>The oven control will only accept correct responses and/or the minimum number of allowable entries for the appropriate feature. The oven control is designed to prevent accidental entries. Review the instructions in this Use & Care Manual for the feature you are trying to use. Also review the minimum and maximum temperature entries for the feature you are trying to set on page 13 in this Use & Care Manual.</p>
Poor baking results.	<p>Many factors affect baking results. Make sure the proper rack position is being used. Center food in the oven and space pans to allow air to circulate. Allow the oven to preheat to the set temperature before placing food in the oven. Try adjusting the recipe's recommended temperature or baking time. If you feel the oven is cooking too hot or cool, see Adjusting the Oven Temperature in this Use & Care Manual.</p>
Self-Cleaning cycle does not work.	<p>Controls are not set properly. Follow instructions in the Self-Cleaning section.</p> <p>Self-cleaning cycle was interrupted. Stop time must be set 2 to 4 hours past the start time. Follow steps under "Stopping or Interrupting a Self-Clean Cycle" under Self-Cleaning.</p>
Soil is not completely removed.	<p>Failure to clean bottom front, top of oven or door areas outside oven seal. These areas are not in the self-cleaning area, but get hot enough to burn on food residue. Clean these areas before starting the self-clean cycle. Burned-on residue may be cleaned with a stiff nylon brush and water or a nylon scrubber. Be careful not to damage the oven gasket.</p> <p>Excessive spillovers in oven. Set Self-Clean cycle for a longer cleaning time.</p>
Flames inside oven or smoking from vent.	<p>Excessive spillovers in oven. This is normal, especially for pie spillovers or large amounts of grease on the oven bottom. Wipe up excessive spillovers before starting the self-clean cycle. If flames or excessive smoke are present, stop the self-clean cycle and follow the steps under "Stopping or Interrupting the Self-Clean Cycle" in the Self-Cleaning section.</p>

Cooking Tables

For Convection Cooking & Roasting

Foods for  CONVECTION BAKE pad *Decrease normal cook time by:	
Frozen foods, pies, pastries and pizza	15-25 %
Refrigerator cookies	15-35 %
Refrigerator biscuits	15-30 %
Rolls & Breads	20-25%
Fresh Pies/Pastries	10-20 %
Begin with the maximum reduction in cook times and adjust as needed.	
*Recommended reduction in cook times based on brands of food items tested. Cook times may vary with your specific brand of food item.	

Foods for  CONVECTION ROAST pad *Decrease normal cook time by:	
Meats	15-30 %
Poultry (unstuffed)	20-30 %
Begin with the maximum reduction in cook times and adjust as needed.	
*Recommended reduction in cook times based on brands of food items tested. Cook times may vary with your specific brand of food item.	

Notes



RANGE WARRANTY

Your range is protected by this warranty

	WARRANTY PERIOD	THROUGH OUR AUTHORIZED SERVICERS, WE WILL:	THE CONSUMER WILL BE RESPONSIBLE FOR:
FULL ONE-YEAR WARRANTY	One year from original purchase date.	Pay all costs for repairing or replacing any parts of this appliance which prove to be defective in materials or workmanship.	Costs of service calls that are listed under NORMAL RESPONSIBILITIES OF THE CONSUMER.*
LIMITED 2ND-5TH YEAR WARRANTY (Glass Smoothtop, Seal & Elements)	Second through fifth years from original purchase date.	Provide a replacement for any defective surface heating element, deteriorated rubberized-silicone seal (upswept models only), or glass smoothtop that cracks due to thermal breakage (not customer abuse).	Diagnostic costs and any transportation and labor costs which are required because of service.
LIMITED WARRANTY (Applicable to the State of Alaska)	Time periods listed above.	All of the provisions of the full and limited warranties above and the exclusions listed below apply.	Costs of the technician's travel to the home and any costs for pick up and delivery of the appliance required because of service.

In the U.S.A., your appliance is warranted by Electrolux Home Products North America, a division of White Consolidated Industries, Inc. We authorize no person to change or add to any of our obligations under this warranty. Our obligations for service and parts under this warranty must be performed by us or an authorized Electrolux Home Products North America servicer. In Canada, your appliance is warranted by WCI Canada, Inc.

*NORMAL RESPONSIBILITIES OF THE CONSUMER

This warranty applies only to products in ordinary household use, and the consumer is responsible for the items listed below:

1. Proper use of the appliance in accordance with instructions provided with the product.
2. Proper installation by an authorized servicer in accordance with instructions provided with the appliance and in accordance with all local plumbing, electrical and/or gas codes.
3. Proper connection to a grounded power supply of sufficient voltage, replacement of blown fuses, repair of loose connections or defects in house wiring.
4. Expenses for making the appliance accessible for servicing, such as removal of trim, cupboards, shelves, etc., which are not a part of the appliance when it was shipped from the factory.
5. Damages to finish after installation.
6. Replacement of light bulbs and/or fluorescent tubes (on models with these features).

EXCLUSIONS

This warranty does not cover the following:

1. CONSEQUENTIAL OR INCIDENTAL DAMAGES SUCH AS PROPERTY DAMAGE AND INCIDENTAL EXPENSES RESULTING FROM ANY BREACH OF THIS WRITTEN OR ANY IMPLIED WARRANTY.
NOTE: Some states do not allow the exclusion or limitation of incidental or consequential damages, so this limitation or exclusion may not apply to you.
2. Service calls which do not involve malfunction or defects in workmanship or material, or for appliances not in ordinary household use. The consumer shall pay for such service calls.
3. Damages caused by services performed by servicers other than Electrolux Home Products North America or its authorized servicers; use of parts other than genuine Electrolux Home Products parts; obtained from persons other than such servicers; or external causes such as abuse, misuse, inadequate power supply or acts of God.
4. Products with original serial numbers that have been removed or altered and cannot be readily determined.

IF YOU NEED SERVICE

Keep your bill of sale, delivery slip, or some other appropriate payment record. The date on the bill establishes the warranty period should service be required. If service is performed, it is in your best interest to obtain and keep all receipts. This written warranty gives you specific legal rights. You may also have other rights that vary from state to state. Service under this warranty must be obtained by contacting Electrolux Home Products:

This warranty only applies in the 50 states of the U.S.A., Puerto Rico, and Canada. Product features or specifications as described or illustrated are subject to change without notice. All warranties are made by Electrolux Home Products North America, a division of White Consolidated Industries, Inc. In Canada, your appliance is warranted by WCI Canada, Inc.

03-U-RA-01 (rev. 01/2001)

USA
800•944•9044
 Electrolux Home Products North America
 P.O. Box 212378
 Augusta, GA 30917

Canada
866•213•9397 (English)
866•294•9911 (French)
 Electrolux Home Products North America
 6150 McLaughlin Road
 Mississauga, Ontario, Canada
 L5R 4C2