

L.P. CONVERSION INSTRUCTIONS

⚠ WARNING:

This conversion must be performed by a qualified installer or gas supplier in accordance with the manufacturer's instructions and all codes and requirements of the authority having jurisdiction. Failure to follow ALL instructions could result in serious injury or property damage. The qualified agency performing this work assumes responsibility for the conversion.

The pressure regulator and the burner orifices are set for natural gas. To use Liquid Propane Gas, the regulator and burner orifices must be converted. The L.P. orifices for the cooktop burners are shipped on the regulator bracket behind the storage drawer. Also, in the same area, is a second bracket holding the L.P. 15K orifice extended spud, choke and set screw for the front right Extra Large cooktop burner (on models so equipped). Remove the storage drawer to locate.

⚠ WARNING:

Do not operate the cooktop or oven burners of this range when using L.P. (bottled) gas before converting the pressure regulator and burner orifices for L.P. gas use. Failure to do so could cause high flames and toxic fumes which can result in serious injury.

To adjust your range for use with L.P. gas, follow these instructions:

1. Disconnect all electrical power, at the main circuit breaker or fuse box.
2. Shut off the gas supply to the range by closing the manual shut-off valve.

CONVERTING THE PRESSURE REGULATOR

- a. Raise the cooktop and locate the pressure regulator.
- b. Follow the direction in 1A or 1B depending on your regulator type.

NOTICE:

If you are using L.P. (bottled) gas, all adjustments described in the following steps must be made before you make any burner adjustments.

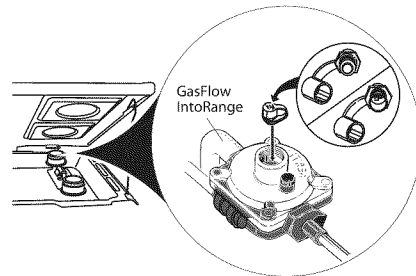

Regulator pictured may differ from your model.

1A-IF THIS IS YOUR REGULATOR

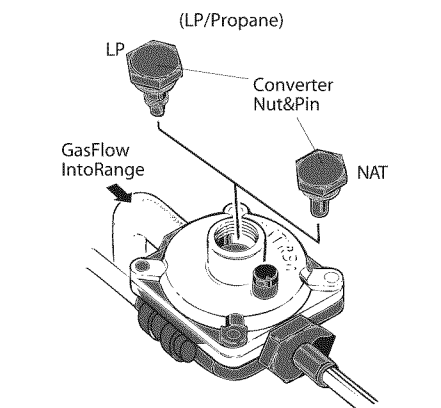

- a. Use an adjustable wrench to remove the hex-nut from the pressure regulator.
- b. Apply sideward finger pressure to remove the plastic pin from the nut.

Note: To remove the pin, place the nut on a flat surface and press the pin sideways with your fingers.

- c. Rotate the pin 180 degrees and snap the pin back into the nut.

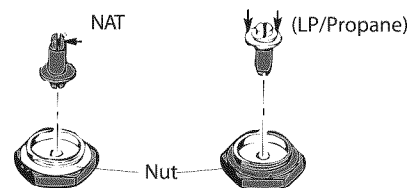

- d. Reinsert the assembly into the regulator and tighten the hex-nut. (Do not over tighten)

1B-IF THIS IS YOUR REGULATOR

- a. Use an adjustable wrench to unscrew the hex-nut cap from the pressure regulator.
- b. Apply pressure and turn counter clockwise to disassembly the plastic cap.

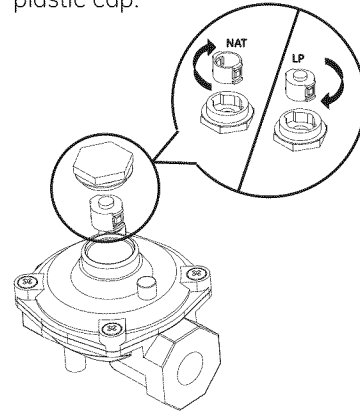

- c. Turn the cap over and hook it into the slots. The type of gas to be used should now be visible in the top of the cap.
- d. Screw back the hex-nut cap into the pressure regulator.

CONVERTING THE COOKTOP BURNERS

- a. Lift the burner assemblies straight up (set aside) to gain access to the surface burner orifice spuds.

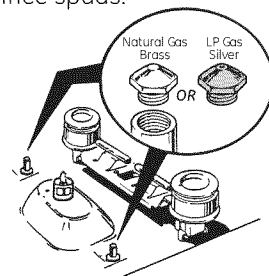

- b. Using a 5/16" nut driver or adjustable wrench, remove each of the four (4) spuds on the surface burner gas inlet tubes.
- c. Replace them with the correct gas spuds mounted in a holder at the right rear of the range, above the regulator. (Natural gas spuds are "BRASS" and LP gas spuds are "SILVER")

NOTICE:

Save these orifices for future conversion back to natural gas.

- d. Return the spuds you removed from the inlet tubes to the holder above the regulator. (To prevent leakage, make sure the spuds are securely screwed into the gas inlet tubes).

- e. Replace the burner assemblies.

ADJUSTMENTS THE OVEN THERMOSTAT

- a. Remove all five (5) knobs, including OVEN CONTROL knob. Remove the four (4) screws located behind the two (2) inner cooktop knobs.
- b. Open the oven door. Remove the three (3) screws located under the manifold panel. Remove the manifold panel.
- c. Located the thermostat bypass screw below the thermostat shaft. Completely loosen the natural gas bypass screw (blue) by turning it counterclockwise. Remove it by gently pulling it out using pliers.
- d. Replace with the LP bypass screw (white) located in the envelope near the rear of the range, above the pressure regulator. Tighten the screw by turning it clockwise.

Turn Screws Counter clockwise to loosen

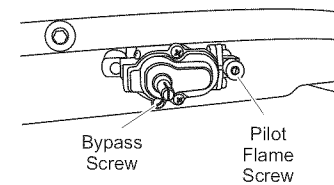

- e. Located the thermostat pilot flame screw to the right of the thermostat shaft.

Completely loosen the natural gas pilot screw (red) by turning it counterclockwise. Remove it by gently pulling it out using Pliers.

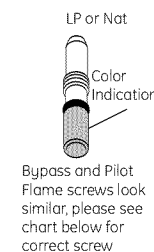

- f. Replace with the LP pilot screw (black) located in the envelope near the rear of the range, above the pressure regulator. Tighten the screw by turning it clockwise.
- g. Replace manifold panel and knobs.

Bypass and Pilot Flame Screws

GAS TYPE	SCREW TYPE	COLOR
Natural Gas	Bypass	Blue
Natural Gas	Pilot	Red
LP (Propane)	Bypass	White or Green
LP (Propane)	Pilot	Black

CONVERTING THE OVEN BURNERS

(on gas oven models only)

BAKE / BROIL BURNER ORIFICE

1. Remove oven door, drawer and oven bottom. The lower burner orifice hood is located behind the drawer (on some models a metal shield must be removed).
2. To convert to LP, use a 1/2" wrench to turn the lower burner orifice hood clockwise (When viewed from above) until it is snug with the base, approximately 2 1/2 turns. (To prevent damage when converting back to Natural Gas, do not over tighten the hood.)

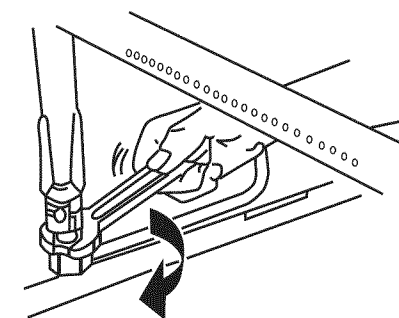

The oven bake burner assembly is located at the lower rear compartment.

A metal shield may need to be removed on some models to access the orifice hood.

AIR SHUTTER SETTINGS FOR BAKE AND BROIL BURNERS

1. Use a screwdriver to loosen the air shutter screw.
2. Adjust the air shutters for LP gas, by rotating the shutter to the fully open position. For natural gas, the shutter should be open 1/2" or about 3/4" of the way open. Your final settings may vary.
3. Retighten the air shutter screw.

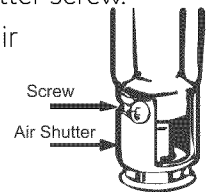

NOTICE:

Make sure the surface burner control knobs are in the OFF position before attempting to light the pilots

Bake and broil flame must be checked with the door closed to properly check flame characteristics.

4. Turn on the gas.
5. Turn on the electricity.
6. Reinstall the oven door.
7. Light both surface burner pilots with a match.
8. To avoid pilot outage, use caution when closing the cooktop after lighting pilots.

ADJUSTING THE SURFACE AND OVEN BURNERS

ADJUSTING THE SURFACE BURNER PILOTS

1. Locate the pilot adjustment screw. It can be accessed through the small hole near the center of the manifold panel.
2. To adjust, use a flat-blade screwdriver with a shaft diameter of less than 3/16". Turn the pilot adjustment screw until the pilot is 5/16" high. Do not reduce the flame to less than 5/16" or a pilot outage may occur. A pilot flame burning higher than recommended may generate soot (carbon black) on the bottom of the cooktop.

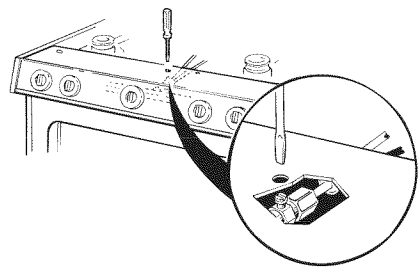

LIGHTING THE OVEN PILOT.

1. Locate the pilot in the back of the oven bottom. The pilot is attached to the left side of the oven burner.
2. To light the oven pilot, push in and hold the oven control knob while lighting the pilot with a long match or match holder.

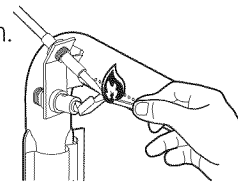

- Once the oven pilot is lit, continue holding the oven control knob for one minute before releasing.
3. The pilot flame size should be approximately 3/8" for LP and 1/2" for natural gas.

CHECKING THE FLAME SIZE

⚠ WARNING:

If you attempt to measure the inner cone of the flame, please use caution; burns could result.

1. Checking the flame size: Check the inner cone of the flame. It should be approximately 1/2" to 3/4" long for the bake and broil burners.

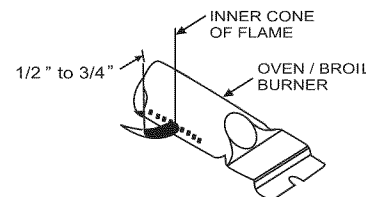

CHECKING THE FLAME QUALITY

The combustion quality of the burner flames need to be determined visually.

NOTE: If burner flames look like (A). Further air shutter adjustment is required. Normal burner flames should look like (B) or (C), depending on the type of gas you use. With LP gas, some yellow tipping on the outer cones is normal.

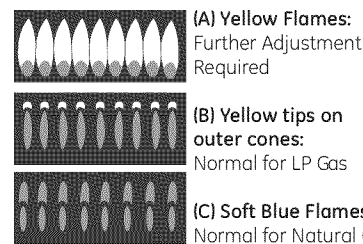

When all adjustments are made and the results are satisfactory:

- a. Replace the orifice fitting cover.
- b. Replace the oven baffle (flame spreader).
- c. Replace the oven bottom.

IN SOME CASES:

- a. With L.P. gas, some yellow tipping on the outer cone is normal.
- b. Foreign particles in the gas line may cause an orange flame at first, but this will soon disappear.

SPECIAL NOTE:

To convert the oven back to natural gas, reverse the instructions given in making L.P. Adjustments.

REPLACE OVEN PARTS

Replace the oven bottom, oven racks, oven door and broil drawer.

NOTICE:

Once the conversion is complete and checked ok, fill out the L.P. Sticker and include your name, organization and date conversion was made. Apply the sticker to the range near the regulator to alert others in the future that this appliance has been converted to L.P. If converting back to natural gas from L.P., please remove the sticker so others know the appliance is set to use natural gas.

ADDITIONAL INFORMATION

BURNER OUTPUT RATINGS: BTU/HR

LP (Propane) Gas, 10" W.C.P.

BURNER	BTU RATE	ORIFICE SIZE
RF	8,000	#66 (.0330 Dia.)
LF	8,000	#66 (.0330 Dia.)
LR	8,000	#66 (.0330 Dia.)
RR	8,000	#66 (.0330 Dia.)
BAKE*	16,000	#56 (0.0465")
+BROIL*	12,000	#59 (0.041")

+ If so equipped.

* Oven burner(s) use convertible hood(s) and are simply adjusted for conversion.

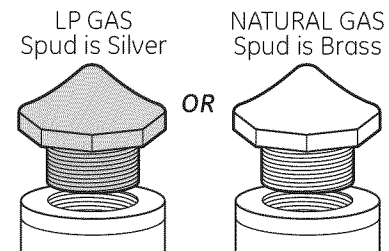

BURNER OUTPUT RATINGS: BTU/HR

NG (Natural) Gas, 4" W.C.P.

BURNER	BTU RATE	COLOR
RF	9,100	#53 (.0590 Dia.)
LF	9,100	#53 (.0590 Dia.)
LR	9,100	#53 (.0590 Dia.)
RR	9,100	#53 (.0590 Dia.)
BAKE*	16,000	#48 (0.076")
~BAKE*	18,000	#46 (0.081")
+BROIL*	12,500	#51 (0.067")

~For Standard models.

+ If so equipped.

* Oven burner(s) use convertible hood(s) and are simply adjusted for conversion.

TOOLS REQUIRED:

- Adjustable wrench
- 1/2" open-end wrench
- Phillips head screwdriver
- Flat bladed screwdriver (blade width approximately 3/32" across)
- Nut drivers: 9/32" or 7mm

L.P. CONVERSION INSTRUCTIONS

183D5578P095

31-21460

DUAL

04-09 CR