

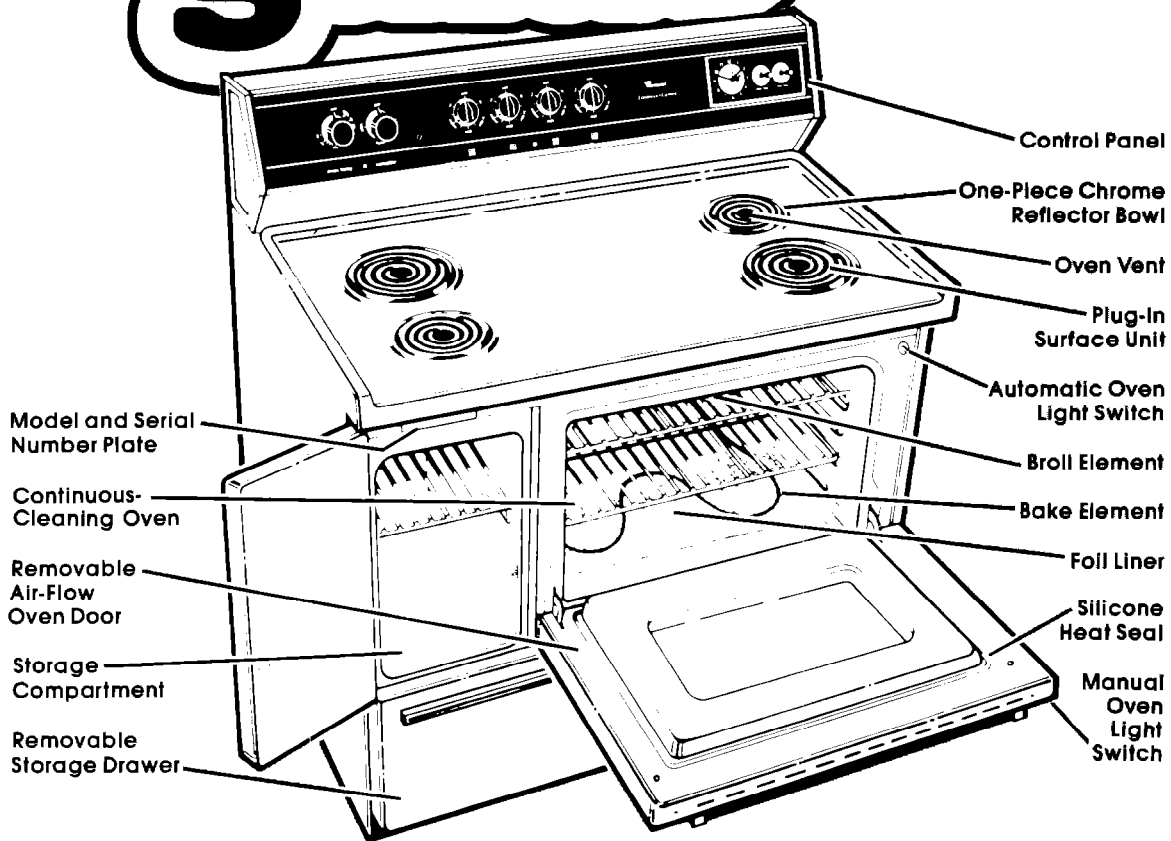

Whirlpool

40-INCH FREE-STANDING ELECTRIC RANGE Model RF4400XL

use & care guide



Copy Your Model and Serial Numbers Here

If you need service, or call with a question, have this information ready.

1. **Complete** Model and Serial Numbers (from the plate just behind the storage compartment door).
2. **Purchase** or installation date from your sales slip.

Copy this information in these spaces. Keep this book, your warrant, and the sales slip together in a handy place.

Model Number

Serial Number

Purchase/Installation Date

Service Company and Phone Number

See the "Cooking Guide" for important safety information.

Your responsibilities...

Proper installation and safe use of your range are your personal responsibilities. Read this "Use and Care Guide" and the "Cooking Guide" carefully for important use and safety information.

Installation

You must be sure your range is...

- installed and leveled on a floor that will hold the weight;
- installed in a well-ventilated area protected from the weather;
- properly connected to the correct electric supply and grounding. (See "Installation Instructions.")

Proper use

You must be sure your range is...

- used only for jobs expected of home ranges;
- used only by people who can operate it properly;
- properly maintained.

Contents

	Page		Page
Responsibilities	2	The Oven Vent	9
Installation	2	The Oven Light	9
Proper Use	2	Cleaning and Caring for Your Range	10
Safety	3	Control Panel and Knobs	10
Using Your Range	4	Surface Units and Reflector Bowls	10
Surface Unit Controls	4	Lift-Up Cooktop	11
Setting the Clock	4	The Oven Door	12
Using the Minute Timer	5	The Continuous-Cleaning Oven	12
Oven Controls	5	Removing the Storage Drawer	14
The Oven Selector	5	Cleaning Chart	15
The Oven Temperature Control	5	If You Need Service or Help	15
Baking or Roasting	6	1. Before You Call for Service	15
Adjusting the Oven Temperature Control	6	2. If You Need Service	15
Broiling	7	3. If You Have a Problem	16
Using the Automatic MEALTIMER Clock	8		Tmk.

Safety



DO NOT allow children to use or play with the range.

DO NOT leave children unattended near the range.



DO NOT store things children might want above the range.



Red surface units and oven heating elements are very hot, but dark units or elements can still be hot enough to burn severely.

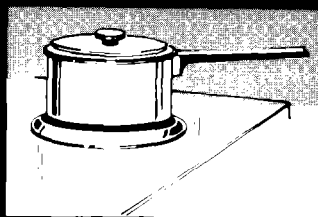

Keep pan handles turned in, but not over another surface unit.

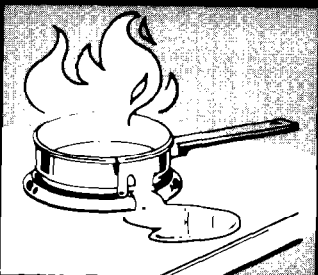

Make sure surface units are off when you are finished, and when you aren't watching.

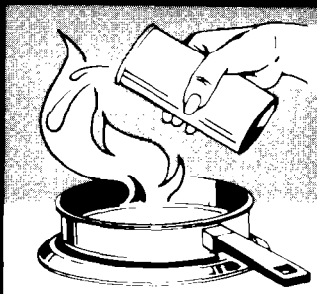

DO NOT use water on grease fires.

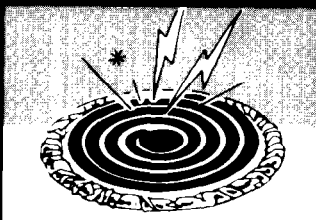

DO NOT line reflector bowls with foil. Shock or fire hazard can result.



DO NOT use a towel or other bulky cloth as a pot holder.

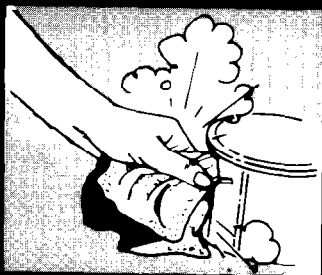

DO NOT use a wet pot holder. Steam burns can result.



DO NOT wear loose or hanging garments when using the range.

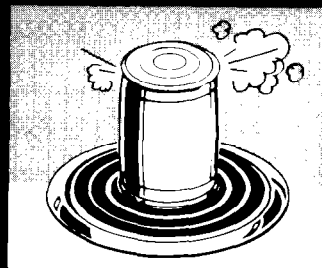

DO NOT heat unopened containers. They can explode.

Remove the Consumer Buy Guide label before using your range.

Using your range

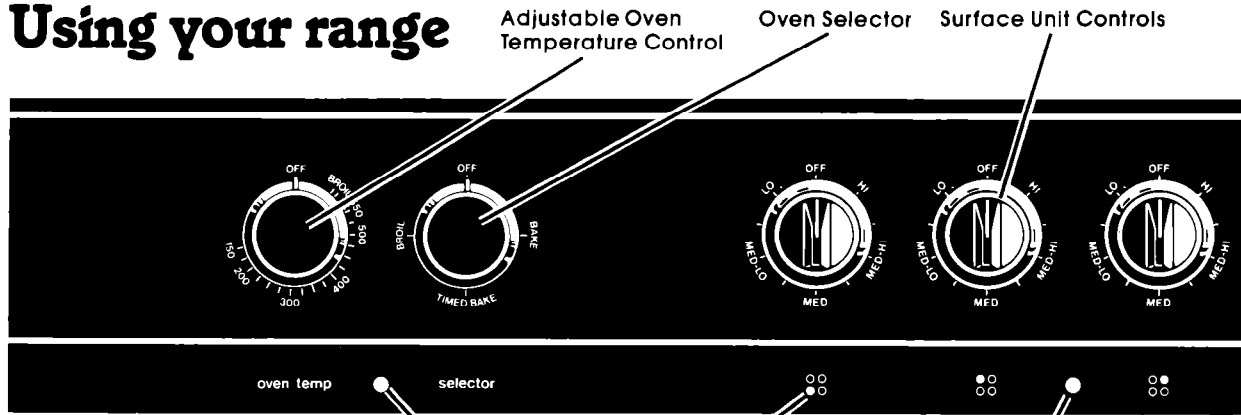

SURFACE UNIT CONTROLS

Control knobs **must be pushed in before turning** them to a setting. They can be set anywhere between HI to OFF.

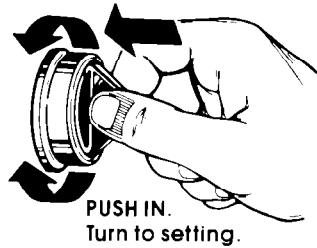

The signal light will glow when a surface unit is on. Be sure the light is off when you are not cooking.

Until you get used to the settings, use the following as a guide.

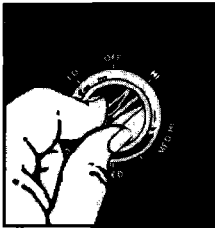

Use **HI** to start foods cooking or to bring liquids to a boil. **Surface unit will not turn red if good contact is made with bottom of pan.**

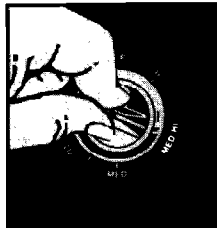

Use **MED-HI** to hold a rapid boil or to fry chicken or pancakes.



Use **MED** for gravy, puddings and icings, or to cook large amounts of vegetables.

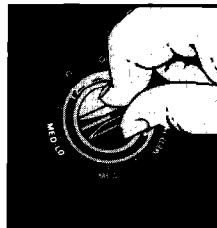

Use **MED-LO** to keep food cooking after starting it on a higher setting.

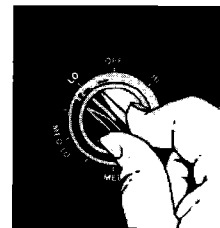

Use **LO** to keep food warm until ready to serve. Set the heat higher or lower within the LO band to keep food at the temperature you want.

SETTING THE CLOCK

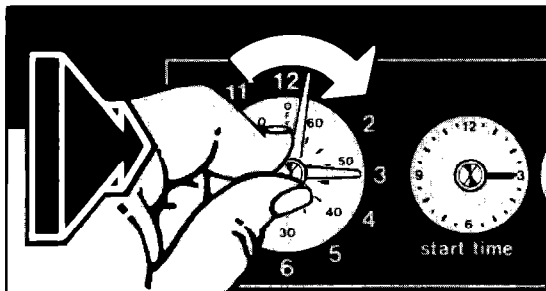

1. Push in Minute Timer Knob and turn clockwise until clock hands show the right time of day.

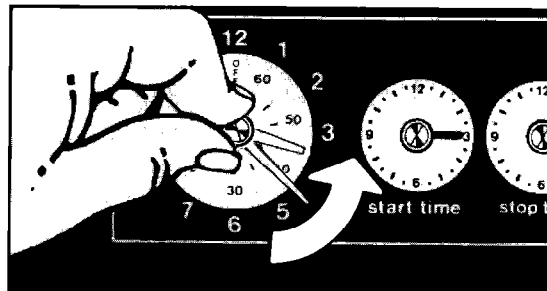

2. Let the Minute Timer Knob pop out. Turn clockwise until the Minute Timer hand points to OFF. If you push in on the knob, you will change the time of day.

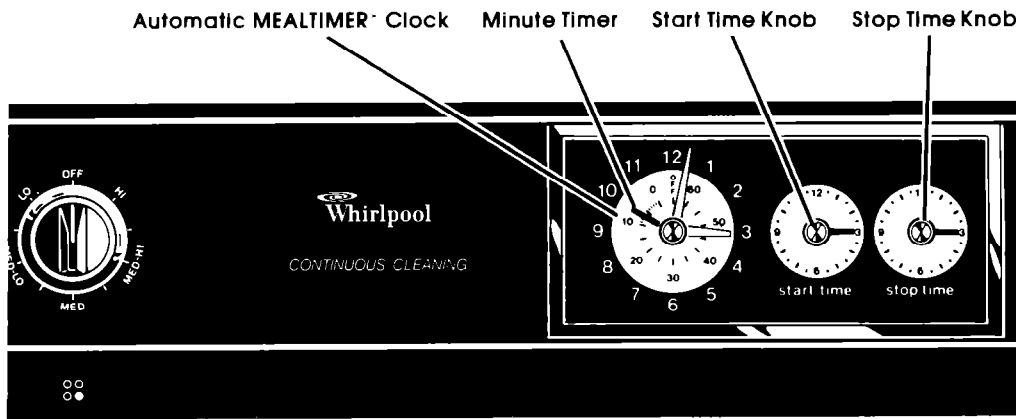

USING THE MINUTE TIMER

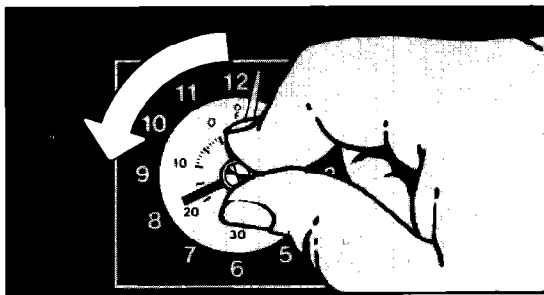

1. Without pushing it in, turn the Minute Timer Knob until the hand passes the setting you want.

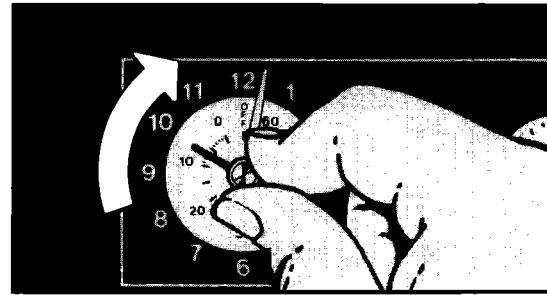

2. Turn the hand back to the setting you want.
3. When the set time is up, a buzzer will sound.
4. Turn the hand to OFF to stop the buzzing.

THE OVEN CONTROLS

The oven is controlled by two knobs: the Oven Selector and the Oven Temperature Control. Both must be on a setting for the oven to heat.

THE OVEN SELECTOR

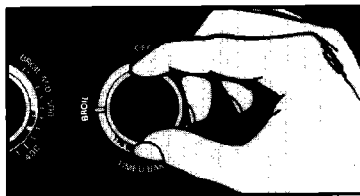

With the Oven Selector on BROIL, only the top element heats. (Broiling, pg. 7).

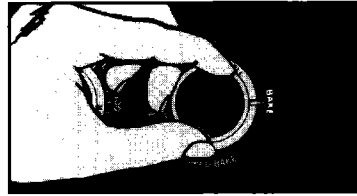

With the Oven Selector on BAKE, the bottom element does most of the work. The top element heats, but does not turn red. (Baking, pg. 6).

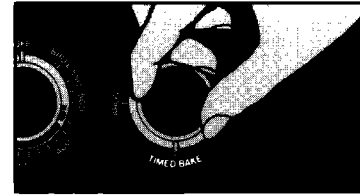

With the Oven Selector on TIMED BAKE, the MEALTIMER Clock can be used to turn the oven on and off automatically. (MEALTIMER Clock, pg.8).

THE OVEN TEMPERATURE CONTROL

Use the Oven Temperature Control to set baking or roasting temperature when the Oven Selector is on BAKE or TIMED BAKE.

When both the Oven Selector and Temperature Control are on BROIL, the broil element heats all the time. The

Oven Temperature Control can be set on a temperature for slower broiling (see Broiling, page 7).

©Tmk

BAKING OR ROASTING

1

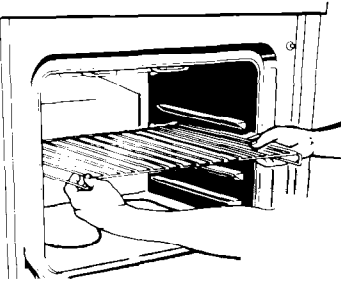

Lift rack at front and pull out.

Put the rack(s) where you want them before turning on the oven. Rack(s) should be placed so food can be centered in the oven. Always leave at least 1½ to 2 inches (4-5 cm) between the sides of the pan and the oven walls and pans. For more information, see the "Cooking Guide."

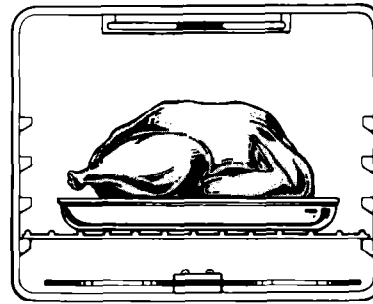

2

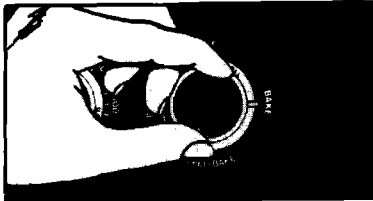

Set the Oven Selector on BAKE.

3

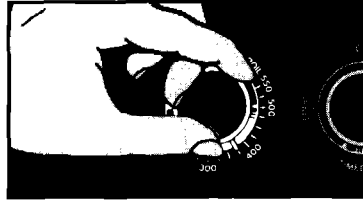

Set the Oven Temperature Control to the baking temperature you want.

4

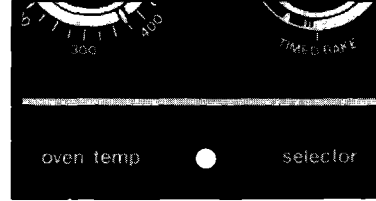

Let the oven preheat until the Signal Light goes off.

5

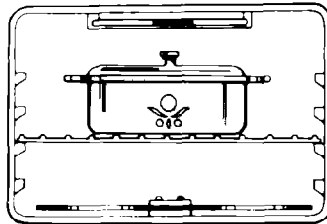

Put food in the oven. *Oven rack, walls and door will be hot.*

6

During baking, the elements will turn on and off to help keep the oven temperature at the setting. The Signal Light will turn on and off with the elements.

The top element helps heat during baking, but does not turn red.

7

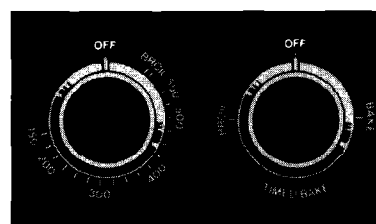

When baking is done, turn both knobs to OFF.

ADJUSTING THE OVEN TEMPERATURE CONTROL

Does your new oven seem to be hotter or colder than your old oven at the same settings? The temperature setting in your old oven may have changed gradually over the years. The accurate setting of your new oven can seem different. If you think the oven temperature needs adjusting, follow these steps:

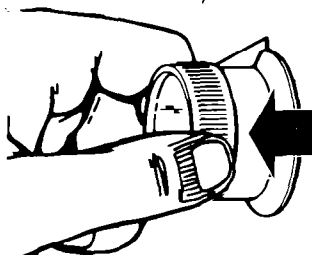

1. Pull out the center of the Oven Temperature Control.

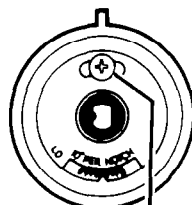

Locking Screw

2. Loosen the locking screw; NOTICE position of notches.



3. To lower the temperature, move black part of knob closer to LO. Each notch equals about 10°F (5°C).

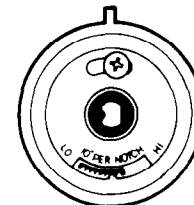

4. To raise the temperature, move black part of knob closer to HI. Each notch equals about 10°F (5°C).

Tighten the locking screw. Replace the knob.

BROILING

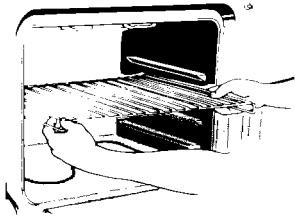

1. Place the rack where you want it for broiling.

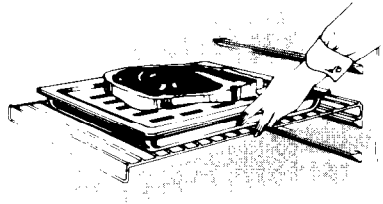

2. Put the broiler pan and food on the rack.

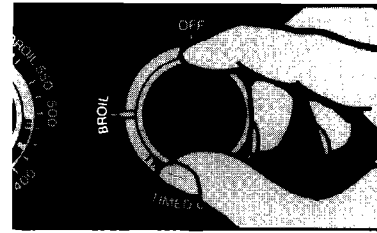

3. Set the Oven Selector on BROIL.

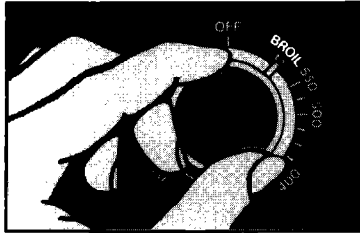

4. Set the Oven Temperature Control on BROIL (or on a lower temperature for slower broiling).

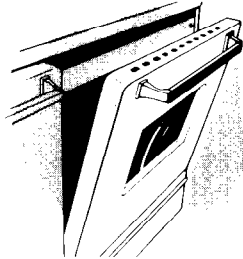

5. During broiling, the oven door must be partly open. A built-in stop will hold it there.

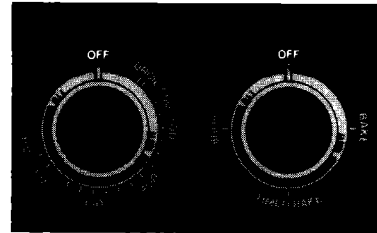

6. When broiling is done, turn both knobs to OFF.

For slower broiling, set the Oven Temperature Control on a temperature instead of BROIL. The broil element will then turn on and off instead of staying on. The lower the temperature setting, the slower the broiling.

The Oven Selector must be on BROIL and the door partly open for all broiling temperatures.

Suggested oven-rack positions and broiling times



Food	Description	inches (cm) from top of food to Broil Element	Approximate Minutes – Temperature set to BROIL	
			1st side	2nd side
Beef Steaks				
Rare	1" (2.5 cm)	3" (8 cm)	7-9	3-5
Medium	1" (2.5 cm)	3" (8 cm)	9-11	4-7
Well done	1" (2.5 cm)	3" (8 cm)	11-13	5-7
Beef Steaks				
Rare	1½" (4 cm)	4"-5" (10-13 cm)	13-15	6-8
Medium	1½" (4 cm)	4"-5" (10-13 cm)	17-19	8-10
Well Done	1½" (4 cm)	4"-5" (10-13 cm)	19-21	14-16
Hamburgers	½" (1 cm)	3" (8 cm)	6-8	4-5
Lamb Chops				
Medium	1" (2.5 cm)	3" (8 cm)	6-8	4-5
Ham slice, precooked or tendered	½"-1" (1-2.5 cm)	3" (8 cm)	6-8	4-5
Canadian Bacon	½" (1 cm)	3" (8 cm)	6	4
Pork Rib or Loin Chop				
Well done	¾"-1" (2-2.5 cm)	4"-5" (10-13 cm)	15	10
Chicken	2-3 lb. (1-1.5 kg) cut in half	7"-9" (18-23 cm)	25-30	10-12
Fish				
whole		3" (8 cm)	11-16	9-14
fillets		3" (8 cm)	7-8	5-7
Liver	½"-¾" (1-2 cm)	3" (8 cm)	3	3
Frankfurters		4"-5" (10-13 cm)	6-7	4-5

USING THE AUTOMATIC MEALTIMER* CLOCK

The Automatic MEALTIMER Clock is designed to turn the oven on and off at times you set...even when you are not around.

To start and stop baking automatically:

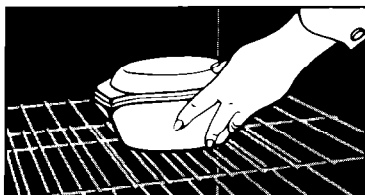

1. Put the racks where you want them and place the food in the oven.

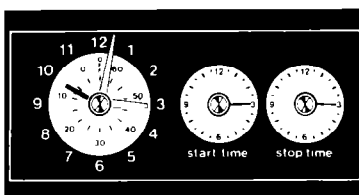

2. Make sure the clock is set to the right time of day.

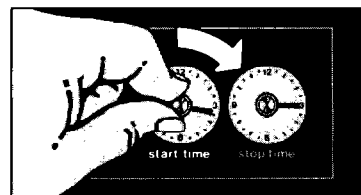

3. Push in and turn the Start Time Knob **clockwise** to the time you want baking to start.

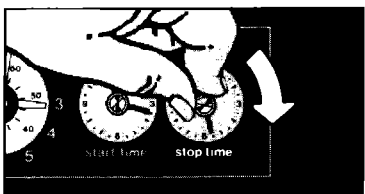

4. Push in and turn the Stop Time Knob **clockwise** to the time you want the oven to shut off.



5. Set the Oven Selector on TIMED BAKE.

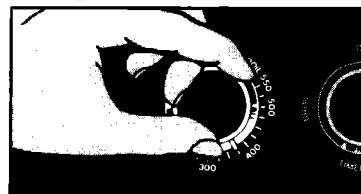

6. Set the Oven Temperature Control on the baking temperature you want.

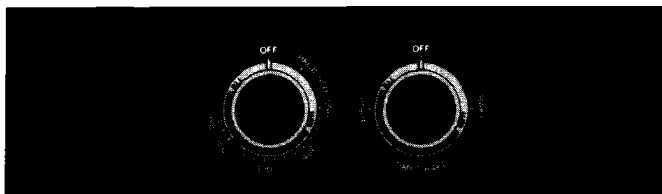

7. After baking is done, turn both knobs to OFF.
8. To stop the oven before the preset time, turn both knobs to OFF.

To stop baking automatically:

1. Make sure the clock is set to the right time of day.
2. Put the racks where you want them and place the food in the oven.
3. Push in and turn the Stop Time Knob **clockwise** to the time you want the oven to shut off.
4. Set the Oven Selector on TIMED BAKE.
5. Set the Oven Temperature Control on the baking temperature you want.
6. After baking is done, turn both knobs to OFF.
7. To stop the oven before the preset time, turn both knobs to OFF.

SPECIAL CAUTION:

Use foods that will not go bad or spoil while waiting for cooking to start. Avoid using dishes with milk or eggs, cream soups, cooked meats or fish, or any item with baking powder or yeast.

Smoked or frozen meats may be used; so can vegetables, fruits and casserole-type foods. Vegetables can be cooked in

a covered baking dish with about a half-cup (118 mL) of water for 1 to 1½ hours.

Any food that has to wait for cooking to start should be very cold or frozen before it is put in the oven. **MOST UNFROZEN FOODS SHOULD NEVER STAND MORE THAN TWO HOURS BEFORE COOKING STARTS.**

THE OVEN VENT

Hot air and moisture escape from the oven through a vent under the right rear surface unit. You can cook on the unit, or keep food warm on it while the oven is on. **Plastic utensils left over the vent can melt.** **Do not block the vent.** Poor baking can result.

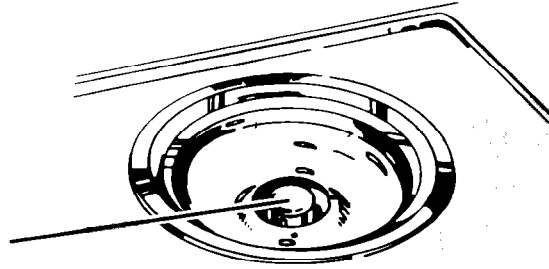

THE OVEN LIGHT

The oven light will come on when you open the oven door or when you pull the Manual Oven Light Switch. Close the oven door or push the switch in to turn off the light.

To replace the light bulb:

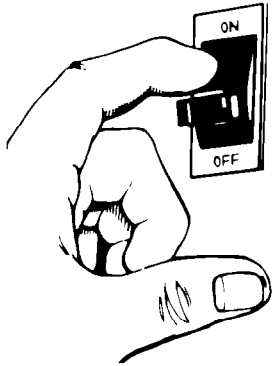

1. Turn off the electric power at the main power supply.

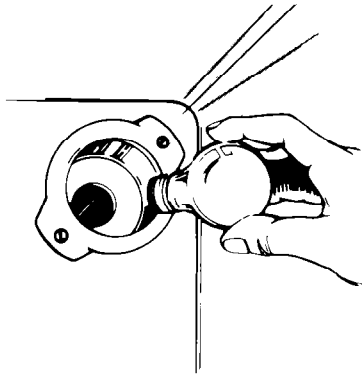

2. Remove the light bulb from its socket.

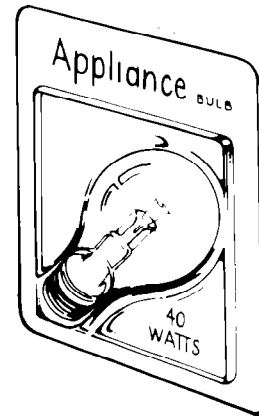

3. Replace the bulb with a 40-watt **appliance** bulb available from most grocery, variety and hardware stores. Turn the power back on at the main power supply.

Cleaning and caring for your range

CONTROL PANEL AND KNOBS

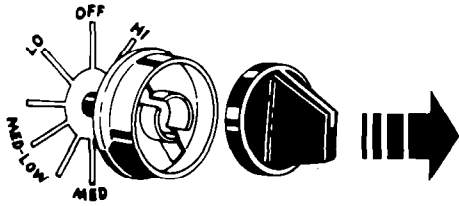

1. First make sure oven and surface unit control knobs are set on OFF. All knobs pull straight off. Surface unit knobs have a collar.



2. Use warm soapy water and a soft cloth to wipe the panel. Rinse and wipe dry.

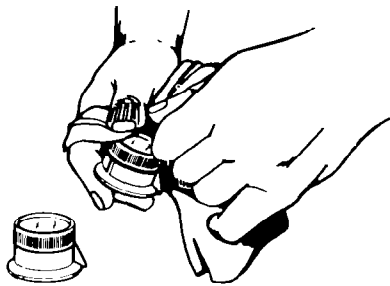

3. Wash knobs and surface unit collars in warm soapy water. Rinse well and dry.

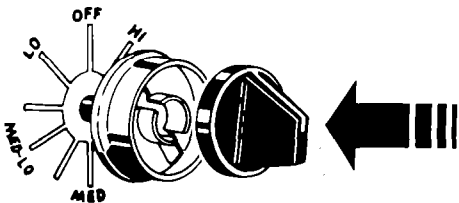

4. Push knobs straight back on. Make sure they point to OFF. Make sure the collar and surface unit knobs are put together as shown.

SURFACE UNITS AND REFLECTOR BOWLS

REMOVING

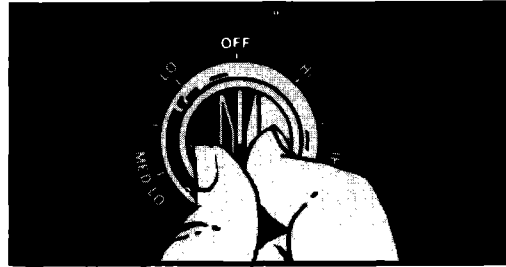

1. Be sure surface units are OFF and COOL.

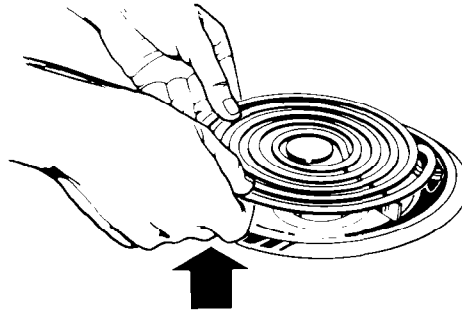

2. Lift the edge of the unit opposite the receptacle just enough to clear the reflector bowl.

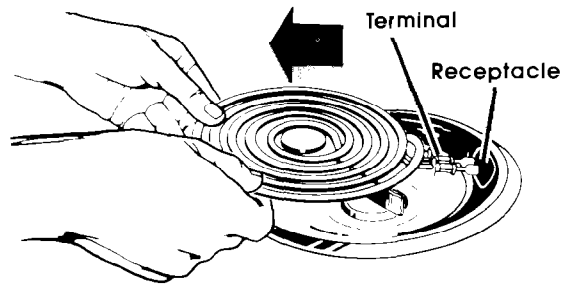

3. Pull the unit straight away from the receptacle.



4. Lift out the reflector bowl.

REPLACING

1. Be sure surface unit controls are **OFF**.

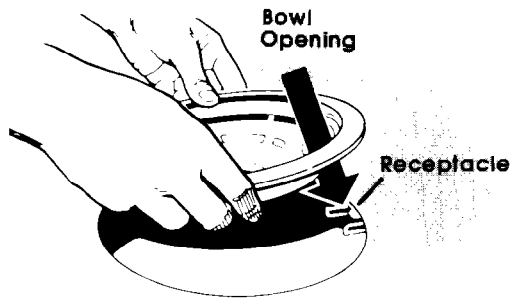

2. Line up opening in the reflector bowl with the surface unit receptacle.

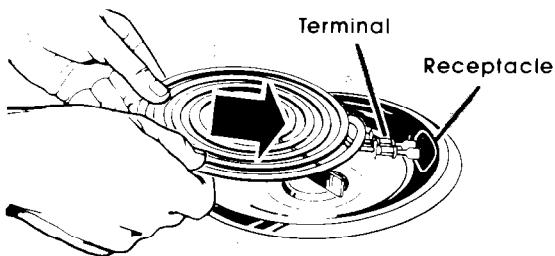

3. Hold the surface unit as level as possible with the terminal just started into the receptacle.



4. While pushing the surface unit terminal into the receptacle, lift a little on the edge of the unit nearest the receptacle.
5. When the terminal is pushed into the receptacle as far as it will go, the surface unit will fit into the reflector bowl.

DO NOT LINE THE REFLECTOR BOWLS WITH FOIL. Use of foil can cause shock or fire hazard.

Reflector bowls reflect heat back to the utensils on the surface units. They also help catch spills. When they are kept clean, they reflect heat better and look new longer.

If a reflector bowl gets discolored, some of the utensils used may not be flat enough. Or some may be too large for the surface unit. In either case, some of the heat that is meant to go into or around a utensil goes down and heats the reflector bowl. This extra heat can discolor it.

LIFT-UP COOKTOP

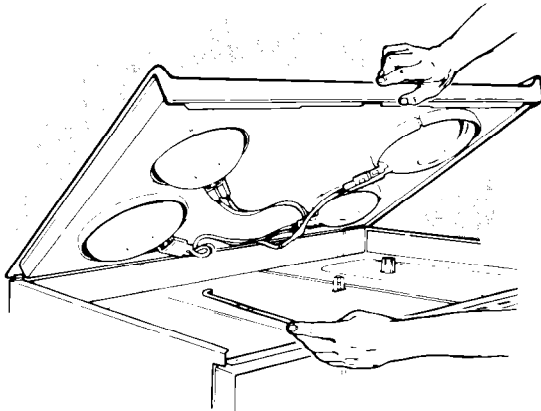

Be sure surface units, cooktop and oven are cool.

1. Lift the front of the cooktop at the center and swing the support rod up.

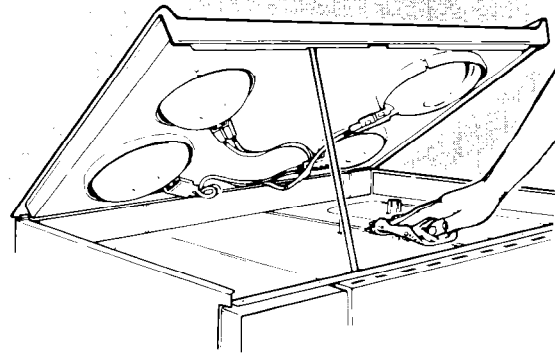

2. Carefully lower the cooktop onto the support rod. Be sure the tip of the rod fits in the notch in the cooktop.
3. Wipe with warm soapy water. Use soapy steel wool pad on stubborn spots.

DO NOT drop the cooktop. Damage can result.

THE OVEN DOOR

REMOVING

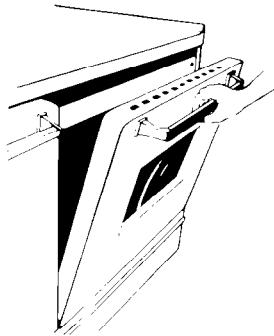

1. Open the door to the broil stop.

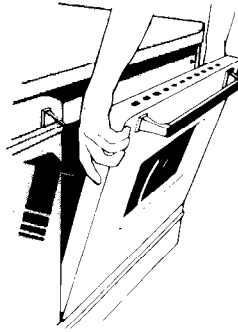

2. Hold the door on both sides and lift slightly to clear the stops in the hinge supports.

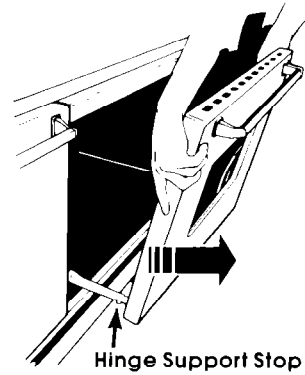

3. Pull the door, with the hinges, straight away from the oven.

REPLACING

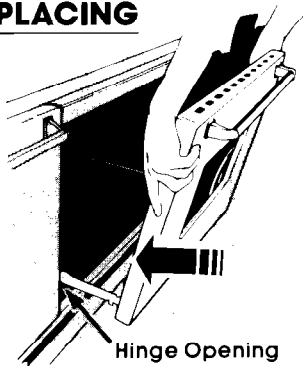

1. Fit the hinge supports into the openings at the bottom oven corners.

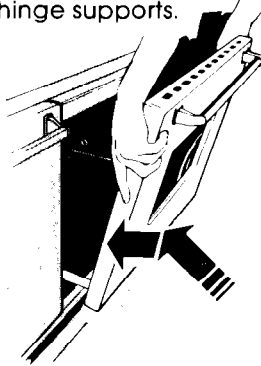

2. Lift slightly while sliding the hinge supports into the openings.

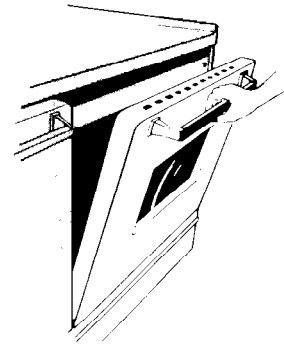

3. When the stops in the hinge supports slide into the oven openings, the door will snap into place and can be closed.

THE CONTINUOUS-CLEANING OVEN

Standard oven walls are coated with smooth porcelain-enamel. Your continuous-cleaning oven walls are coated with a special, rougher porcelain-enamel.

A fat spatter beads up on the smooth surface, but spreads out on the rougher surface. The bead of fat chars and turns black. The spread-out fat **gradually** burns away at **medium to high baking temperatures** (350°-475°F, 176°-231°C) so the oven can return to a presentably clean condition.

Fat Spatter
Beads Up,
Turns Black

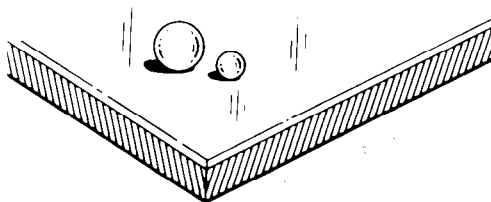

Standard porcelain-enamel

Fat Spatter
Spreads Out,
Burns Away

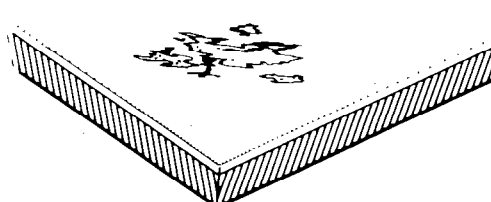

Continuous-cleaning porcelain-enamel

TIPS

1. The oven window and racks do not have the continuous-cleaning surface. Clean them by hand.
2. The oven door does not get as hot as the walls. Some hand cleaning may be needed.
3. If you do more broiling than baking, hand cleaning may be needed.
4. Use aluminum foil on the oven bottom according to instructions. Spillovers do not burn away and may stain the bottom.

HAND CLEANING

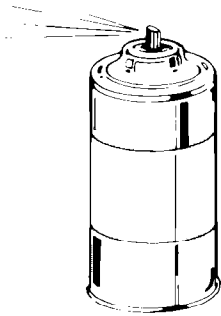

DO NOT USE OVEN CLEANING PRODUCTS. Some can be trapped in the porcelain-enamel surface and give off harmful fumes.

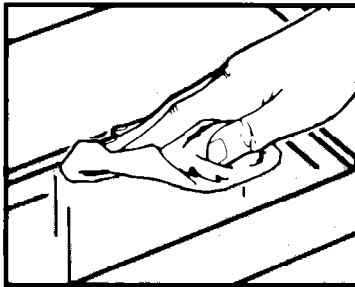

WINDOW – Keep clean with hot sudsy water. Do not use steel wool or abrasive cleansers. Use a plastic scouring pad for stubborn spots. Rinse well.

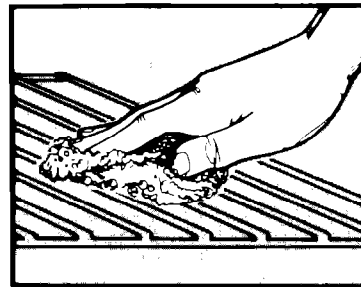

RACKS – Use a soapy steel-wool pad for best results. Rinse well.

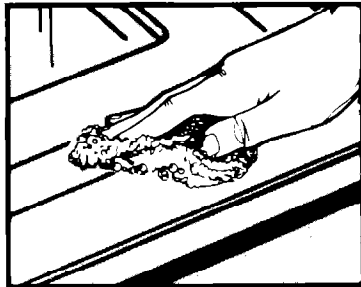

WALLS AND DOOR – Wash with hot soapy water. Use a soapy steel-wool pad or plastic scouring pad for stubborn spots. Rinse well.

USING FOIL

Foil must be used on the oven bottom to catch spillovers. The foil must be used properly.

Cut foil from a roll of heavy-duty 18-inch (45 cm) aluminum foil, or buy a foil kit (Part No. 241430) from your Whirlpool Appliance dealer.

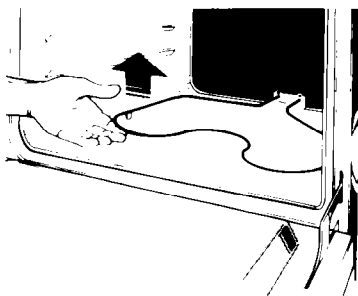

Lift the **cool bake element** slightly to lift the feet off the oven bottom.

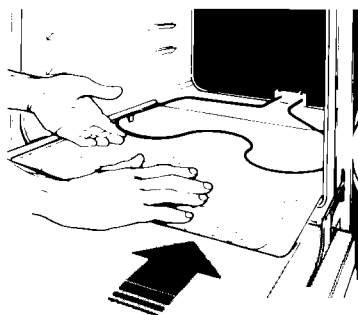

Slide the foil under the bake element.

Make sure foil is centered, long enough to start up both sides, and lying flat without wrinkles.

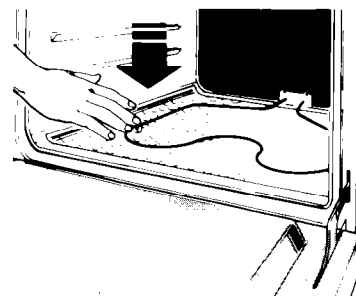

For proper baking, lower the bake element **so all feet rest solidly on the foil.**

STORAGE DRAWER AND COMPARTMENT

The storage drawer and compartment are for storing pots and pans. **Never store anything in them that can burn or melt.** Use care when handling the drawer.

REMOVING THE STORAGE DRAWER

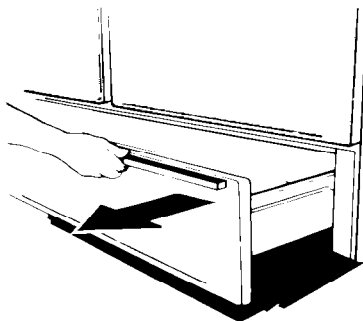

1. Pull drawer straight out to the first stop.

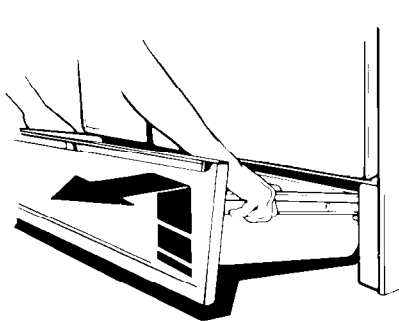

2. Lift front and pull out to the second stop.

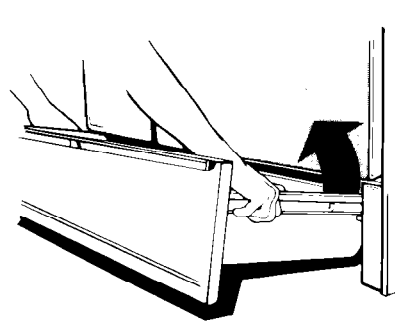

3. Lift back slightly and slide drawer all the way out.

REPLACING THE STORAGE DRAWER

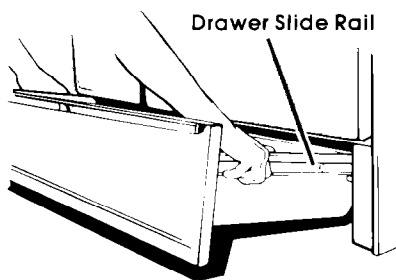

1. Fit ends of Drawer Slide Rails into drawer guides or both sides of opening.

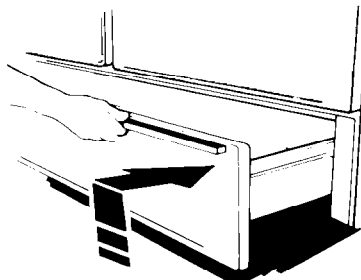

2. Lift drawer front and push in until metal stops (on drawer slide rails) clear white stops on drawer guides.

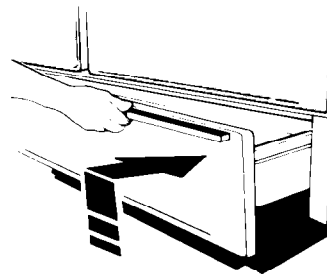

3. Lift drawer front to clear second stop and slide drawer closed.

CLEANING CHART

PART	WHAT TO USE	HOW TO CLEAN
Control knobs	Warm, sudsy water and bristle brush	<ul style="list-style-type: none"> • Wash, rinse and dry well. • Do not soak.
Control panel	Warm, soapy water Commercial glass cleaner	<ul style="list-style-type: none"> • Wash, rinse and dry with soft cloth. • Follow directions with cleaner.
Broiler pan and grid	Warm, soapy water or soapy steel wool pads	<ul style="list-style-type: none"> • Wash with other cooking utensils.
Oven racks	Warm, soapy water or soapy steel wool pads	<ul style="list-style-type: none"> • Wash, rinse and dry. Use soapy steel wool pads for stubborn areas.
Oven door glass	Warm, soapy water or plastic scrubbing pad Commercial glass cleaner	<ul style="list-style-type: none"> • Make certain oven is cool. Wash, rinse and dry well with soft cloth. • Follow directions provided with cleaner.
Continuous Cleaning Oven	Warm, soapy water or soapy steel wool pads	<ul style="list-style-type: none"> • Clean stubborn spots or stains. Rinse well with clean water. • Do not use commercial oven cleaners. • Place strip of aluminum foil on bottom of oven to catch spillovers. See page 14. • Follow directions given on page 12.

Most fat splatters on porcelain-enamel interior surface gradually reduce to a presentably clean condition during normal baking or roasting operations.

If you need service or help, we suggest you follow these three steps:

1. BEFORE YOU CALL FOR SERVICE*:

If your range does not seem to be operating properly, check the following before calling for service.

If nothing operates:

- Is the range plugged into an operating outlet or wired into a live circuit with the proper voltage? (See **Installation Instructions**.)
- Have you checked the main fuse or circuit-breaker box?

If the oven will not operate:

- Is the Oven Selector turned to a setting (BAKE or BROIL, but not TIMED BAKE)?
- Is the Oven Temperature Control turned to a temperature setting?

If surface units will not operate:

- Have you checked the main fuse or circuit-breaker box?
- Are surface units plugged in all the way?
- Do the control knobs turn?

If surface unit control knob or knobs will not turn:

- Did you push in before trying to turn?

If soil is visible on continuous-cleaning oven finish:

- The special finish is designed to gradually



reduce oven soil during normal baking or roasting. It is not designed to keep your oven spotless...only presentably clean.

- If you broil often, you may see oven soil.
- The door is cooler than oven walls. Soil will be more visible on the door than other areas in the oven. See page 13, "Hand Cleaning."

If cooking results aren't what you expect:

- Is the range level?
- Are you using pans recommended in the **Cooking Guide**?
- If baking, have you allowed 1½ to 2 inches (4-5 cm) on all sides of the pans for air circulation?
- Does the oven temperature seem too low or too high? See page 6, "Resetting the oven temperature control."
- Have you preheated the oven as the recipe calls for?
- Are the pans the size called for in the recipe?
- Are you following a tested recipe from a reliable source?
- Do the cooking utensils have smooth, flat bottoms?
- Do the cooking utensils fit the surface unit being used?

See the **Cooking Guide** for more information on cooking problems and how to solve them.

2. IF YOU NEED SERVICE*:

If your WHIRLPOOL® appliance ever needs service anywhere in the United States, help is just a phone call away...to your nearest Whirlpool franchised TECH-CARE® service representative.

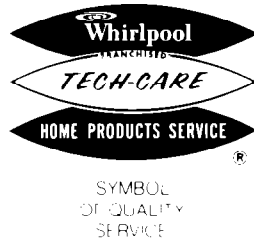

Whirlpool maintains a nationwide network of franchised TECH-CARE service companies to fulfill your warranty and provide after-warranty service and maintenance to keep your WHIRLPOOL appliance in peak condition.

You'll find your nearest TECH-CARE service company listed in your local telephone book Yellow Pages under APPLIANCES – HOUSEHOLD – MAJOR – SERVICE AND REPAIR. **Should you not find a listing, dial the Whirlpool COOL-LINE® service assistance toll-free telephone number:**

Continental U.S. Dial (800) 253-1301
In Michigan Dial (800) 632-2243
Alaska and Hawaii . Dial (800) 253-1121

If you move...To make sure that your appliance is correctly installed and to insure its continued satisfactory operation, please telephone your nearest TECH-CARE service company for installation or to get the name of a qualified installer. (Installation cost will, of course, be paid by you.)

Helpful hints...You can help your TECH-CARE service representative give you faster service if you include the model and serial number of your appliance when requesting service. Also, retain your sales slip and warranty to verify your warranty status.



Remember...Your TECH-CARE service representative is specially trained in the expert repairing and servicing of your WHIRLPOOL appliances. He can help you maintain the quality originally built into your WHIRLPOOL appliance. So why not take the time, now, to look up his telephone number and jot it down in the space provided on the cover.

3. IF YOU HAVE A PROBLEM*:

Call Whirlpool Corporation in Benton Harbor at the COOL-LINE service assistance telephone number (see step 2) or write:

Mr. Guy Turner, Vice President
Whirlpool Corporation
Administrative Center
2000 U.S. 33 North
Benton Harbor, Michigan 49022

If you must call or write, please provide: your name, address, telephone number, type of appliance, brand, model, serial number, date of purchase, the dealer's name, and a complete description of the problem. This information is needed in order to better respond to your request for assistance.



FSP is a registered trademark of Whirlpool Corporation for quality parts. Look for this symbol of quality whenever you need a replacement part for your Whirlpool appliance. FSP replacement parts

will fit right and work right, because they are made to the same exacting specifications used to build every new Whirlpool appliance.



Benton Harbor, Michigan. Automatic Washers. Clothes Dryers. Freezers. Refrigerator-Freezers. Ice Makers. Dishwashers. Built-in Ovens and Surface Units. Ranges. Microwave Ovens. Compactors. Room Air Conditioners. Dehumidifiers. Central Heating and Air Conditioning Systems.

Quality. Our way of life.