



Room Air Conditioners

Safety Information

Adapter Plugs 4
 Connecting Electricity 3
 Extension Cords 4
 Safety Precautions 2

Operating Instructions

Air Direction 6
 Controls 5, 6
 Fan Switch 6
 Temperature Limiting 6
 Vent Control 6

Care and Cleaning

Air Filter 8
 Front Grille 7
 Grille and Case 7
 Outdoor Coils 7

Installation

Installing a J-Model in an Existing Wall Case 10-12
 Preparing to Install 9

Troubleshooting Tips

Before You Call For Service 14
 Normal Operating Sounds 14

Consumer Support

Consumer Support Back Cover
 Warranty 15

Write the model and serial numbers here:

Find these numbers on a label on the front of the base pan behind the front grille.

Owner's Manual and Installation Instructions

Chassis Only

<i>Cool Only:</i>	AJCH 08, 10	ACA
	AJCH 10, 12	DCA
	AJCS 06	LCA
	AJCS 08, 10	ACA
	AJCS 09, 10, 12	DCA
<i>Heat/Cool:</i>	AJES 09, 10, 12	DCA
	AJEH 12	DCA
<i>Heat Pump:</i>	AJHS 08, 10	DCA



IMPORTANT SAFETY INFORMATION. READ ALL INSTRUCTIONS BEFORE USING.

⚠ WARNING!

For your safety, the information in this manual must be followed to minimize the risk of fire or explosion, electric shock, or to prevent property damage, personal injury, or loss of life.



SAFETY PRECAUTIONS

- Use this appliance only for its intended purpose as described in this Owner's Manual.
 - This air conditioner must be properly installed in accordance with the Installation Instructions before it is used.
 - Never unplug your air conditioner by pulling on the power cord. Always grip plug firmly and pull straight out from the receptacle.
 - Repair or replace immediately all electric service cords that have become frayed or otherwise damaged. Do not use a cord that shows cracks or abrasion damage along its length or at either the plug or connector end.
 - Turn the mode control to **OFF** and unplug your air conditioner before making any repairs or cleaning.
- NOTE:** We strongly recommend that any servicing be performed by a qualified individual.
- For your safety...do not store or use combustible materials, gasoline or other flammable vapors or liquids in the vicinity of this or any other appliance.

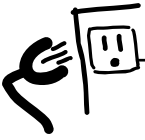

HOW TO CONNECT ELECTRICITY

Do not, under any circumstances, cut or remove the third (ground) prong from the power cord. For personal safety, this appliance must be properly grounded.

The power cord of this appliance is equipped with a 3-prong (grounding) plug which mates with a standard 3-prong (grounding) wall outlet to minimize the possibility of electric shock hazard from this appliance.

Have the wall outlet and circuit checked by a qualified electrician to make sure the outlet is properly grounded.

Where a 2-prong wall outlet is encountered, it is your personal responsibility and obligation to have it replaced with a properly grounded 3-prong wall outlet.

The air conditioner should always be plugged into its own individual electrical outlet which has a voltage rating that matches the rating plate.

This provides the best performance and also prevents overloading house wiring circuits which could cause a fire hazard from overheated wires.

See the Installation Instructions, *Electrical Requirements* section for specific electrical connection requirements.

IMPORTANT SAFETY INFORMATION. READ ALL INSTRUCTIONS BEFORE USING.

⚠ WARNING!



USE OF EXTENSION CORDS—115-Volt models only

Because of potential safety hazards under certain conditions, we strongly recommend against the use of an extension cord.

However, if you must use an extension cord, it is absolutely necessary that it be a UL-listed, 14 gauge, 3-wire grounding type appliance extension cord having a grounding type plug and outlet and that the electrical rating of the cord be 15 amperes (minimum) and 125 volts.

⚠ CAUTION:

DO NOT use an extension cord with any of the 230/208 volt models.



USE OF ADAPTER PLUGS—115-Volt models only

Because of potential safety hazards under certain conditions, we strongly recommend against the use of an adapter plug.

However, if you must use an adapter, where local codes permit, a **temporary connection** may be made to a properly grounded 2-prong wall outlet by use of a UL-listed adapter available at most local hardware stores.

The larger slot in the adapter must be aligned with the larger slot in the wall outlet to provide proper polarity in the connection of the power cord.

When disconnecting the power cord from the adapter, always hold the adapter in place with one hand while pulling the power cord plug with the other hand. If this is not done, the adapter ground terminal is very likely to break with repeated use.

If the adapter ground terminal breaks, **DO NOT USE** the air conditioner until a proper ground has been established.

Attaching the adapter ground terminal to a wall outlet cover screw does not ground the appliance unless the cover screw is metal, and not insulated, and the wall outlet is grounded through the house wiring. You should have the circuit checked by a qualified electrician to make sure the outlet is properly grounded.



READ AND FOLLOW THIS SAFETY INFORMATION CAREFULLY.

SAVE THESE INSTRUCTIONS

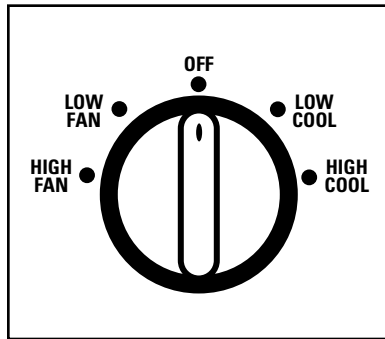
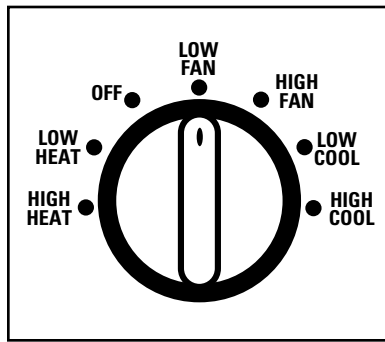

MODE CONTROL

1

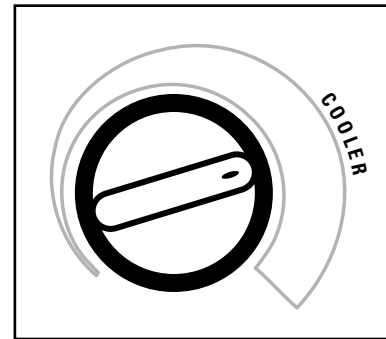
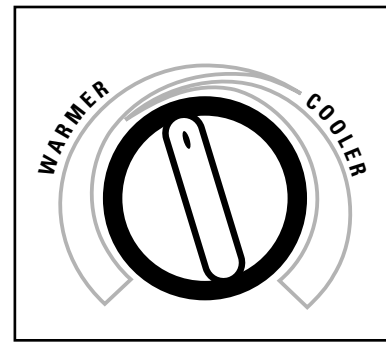

TEMP CONTROL

2



Controls

- 1 Mode Control**
- HIGH COOL** and **LOW COOL** provide cooling with different fan speeds.
 - HIGH HEAT** and **LOW HEAT** provide heating with different fan speeds.
 - LOW FAN** or **HIGH FAN** provides air circulation and filtering without cooling or heating.

NOTE: If you move the switch from a cool or heat setting to OFF or to a fan setting, wait at least 3 minutes before switching back to a cool or heat setting. A 3-minute delay is automatically provided on the Heat/Cool and Heat Pump models.

Cooling/Heating Descriptions

For Normal Cooling or Heating—Select **HIGH COOL** or **HIGH HEAT** with the thermostat at mid point.

For Maximum Cooling—Select **HIGH COOL** with the thermostat at maximum cool.

For Maximum Heating—Select **HIGH HEAT** with the thermostat at maximum heat.

For Quieter & Nighttime Cooling—Select **LOW COOL** with the thermostat at mid point.

- 2 Temp Control**
- The temp control is used to maintain the room temperature. The compressor will cycle on and off to keep the room at the same level of comfort. When you turn the knob to **COOLER** (blue) the indoor air will become cooler. Turn the knob to **WARMER** (red) and the indoor air will become warmer.

Heat Pump Models

When the outdoor temperature is lower than 25°F., heat is provided by the electric heater in the air conditioner instead of by the heat pump.

NOTE: The electric resistance heater in the 115-volt heat pump model operates during defrost when the outdoor coil temperature is below 36°F. It is not intended to provide full heat capability.

About the controls on the air conditioner.

Fan Switch

On Heat/Cool models, the fan switch lever is located in a hole through the control panel. To reach it, you need to remove the front grille. Use a small screwdriver to change the setting. Cool only models have a rocker switch on the front of the control box.

When set at **CYCLE** (down) the fan cycles on and off when cooling or heating. When set at **CONT** (continuous, up) the fan runs all the time. The unit is shipped in the **CONT** setting.

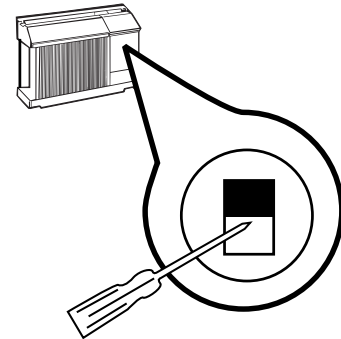

Temperature Limiting

Limiting the maximum and minimum settings prevents users from turning the control to the extreme heat or cool positions.

The normal range of the temp control is approximately 60°F to 85°F. The control range may be narrowed by the use of the temperature limiting screws located behind the control panel.

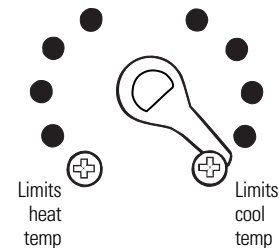

Each position equals approximately 3°F.

Vent Control

The vent control is located behind the front grille on the right side of the air discharge area. When set at **CLOSE**, only the air inside the room will be circulated and conditioned. When set at **OPEN**, some inside air is exhausted outside.

To open or close the vent:

1. Remove the front grille.
2. Remove and replace the vent card to the **OPEN** (mesh end toward the back) or to the **CLOSE** (mesh end toward the front) position.

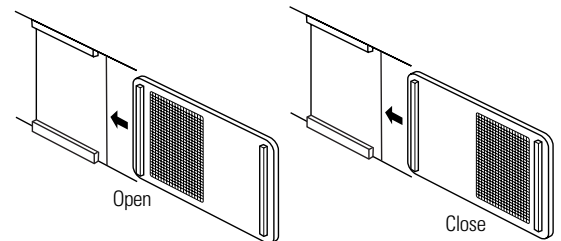

Air Direction

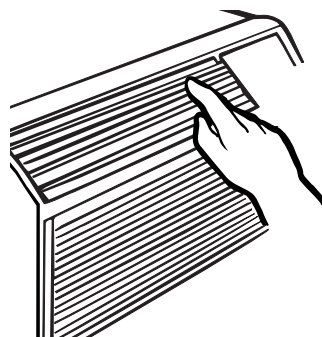

Horizontal louvers on the front grille let you control the air direction up and down.

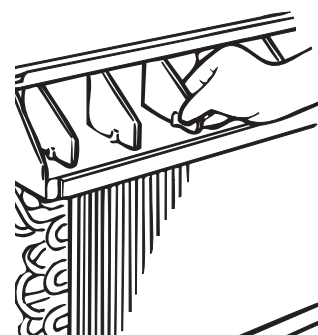

Remove the front grille to adjust the vertical louvers side-to-side to direct the air left or right.

Grille and Case

Turn the air conditioner off and remove the plug from the wall outlet before cleaning.

To clean, use water and a mild detergent. Do not use bleach or abrasives.

Outdoor Coils

The coils on the outdoor side of the air conditioner should be checked regularly. If they are clogged with dirt or soot they may be professionally steam cleaned, a service available through your GE service outlet.

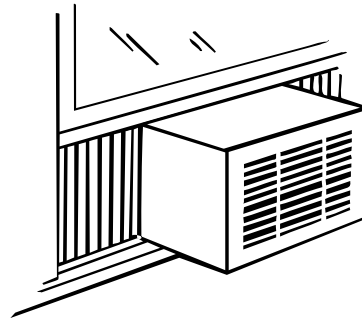

Front Grille

The front grille can be removed for more thorough cleaning or to make the model and serial numbers accessible.

To remove:

1. Pull the filter out.
2. Remove the two grille screws.

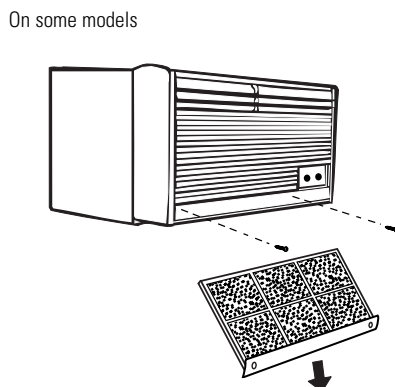
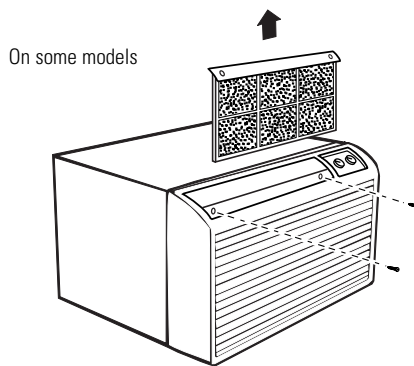

3. Pull the grille out from the bottom and lift up from the tabs on the top of the case.

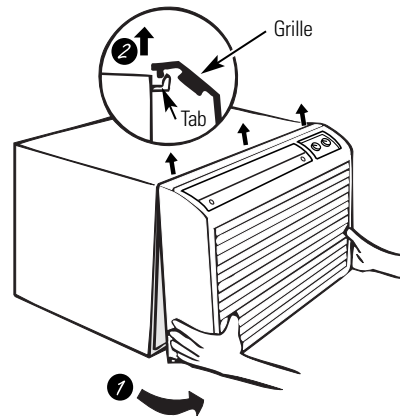

To replace:

Hook the tabs on the front grille even with the tabs on the case and snap into place.

Replace the screws and filter.

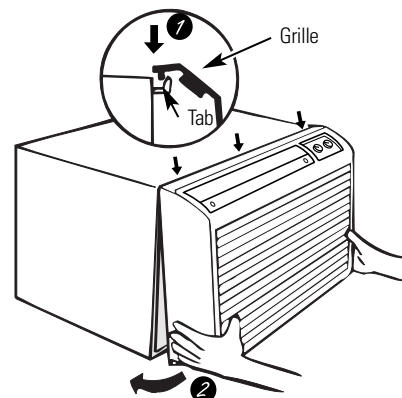

Care and cleaning of the air conditioner.

To maintain optimum performance, clean the filter at least every 30 days.

Air Filter

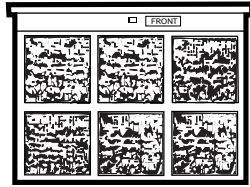

Dirty filter—Needs cleaning

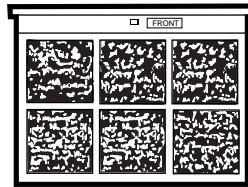

Clogged filter—Greatly reduces cooling, heating and airflow.

Turn the air conditioner off before cleaning.

The most important thing you can do to maintain the air conditioner is to clean the filter at least every 30 days. A clogged filter reduces cooling, heating and air flow.

Keeping the air filter clean will:

- Decrease cost of operation.
- Save energy.
- Prevent clogged heat exchanger coils.
- Reduce the risk of premature component failure.

To clean the air filters:

- Vacuum off the heavy soil.
- Run water through the filters.
- Dry thoroughly before replacing.

To remove the air filter, on some models:

Carefully pull the tab forward, up and out.

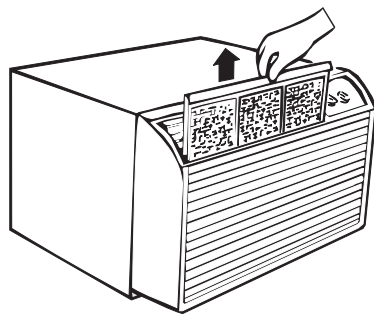

To remove the air filter, on other models:

Pull it down.

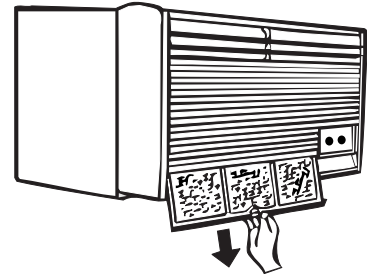

To replace the air filter:

Replace the clean filter by pushing it back into place.

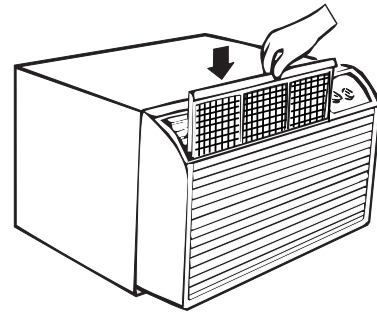

CAUTION: Do not operate the air conditioner without the filter in place. If a filter becomes torn or damaged it should be replaced immediately.

Operating without the filter in place or with a damaged filter will allow dirt and dust to reach the indoor coil and reduce the cooling, heating, airflow and efficiency of the unit.

Replacement filters are available from your salesperson, GE dealer, GE Service and Parts Center or authorized Customer Care® servicers.

Preparing to install the air conditioner.

Read these instructions completely and carefully.



Before You Begin

NOTE TO INSTALLER: Leave these instructions with the air conditioner after installation is completed.

NOTE TO CONSUMER: Keep this Owner's Manual and Installation Instructions for future use.

IMPORTANT NOTES:

For personal safety, this air conditioner must be properly grounded.

It is important to have the wall outlet and circuit checked by a qualified electrician if there is any doubt as to whether a proper ground exists.

Follow National Electric Codes (NEC) and/or local codes and ordinances.

CAUTION:

Do not, under any circumstances, cut or remove the third (ground) prong from the power cord.

Do not change the plug on the power cord of this air conditioner.

Aluminum house wiring may present special problems—consult a qualified electrician.



Electrical Requirements



Some models require 115/120-volt a.c., 60 Hz grounded outlet protected with a 15-amp time delay fuse or circuit breaker.

The 3-prong grounding plug minimizes the possibility of electric shock hazard. If the wall outlet you plan to use is only a 2-prong outlet, it is your responsibility to have it replaced with a properly grounded 3-prong wall outlet.



Some models require 230/208-volt a.c., protected with a time delay fuse or circuit breaker. These models should be installed on their own single branch circuit for best performance and to prevent overloading house or apartment wiring circuits, which could cause a possible fire hazard from overheating wires.

Installing a J-Model in an existing wall case.

Read these instructions completely and carefully.



IMPORTANT!

GE strongly recommends the removal of the old wall case and the installation of a new GE Wall Case. If you decide to keep the existing wall case, you may need a kit to ensure proper performance. If you **DO NOT** use a kit, you run the risk of poor performance or product failure. This is not covered under the terms of the GE warranty.



J-Model Qualifying Questions

J-model air conditioners may fit in existing wall cases. However, they often need a kit to properly adapt the case to the GE air conditioner. Answer these questions and see the chart below for the proper kit.

- A** What brand air conditioner will you be replacing?
- B** What are the dimensions of the wall case currently in use?
- C** What is the model number of the chassis currently in use? What is the model (or Type) number of the wall case currently in use?

Frequently, the J-model adapter kit will apply to another brand model “series” or specific vintage. In these cases, you need the chassis model number and/or the wall case or “type” number to confirm the use of the correct adapter kit.

- D** What type of outdoor grille is used with the current wall case?

There may be an architectural grille attached to a wall case to enhance the exterior appearance of the building. Custom grilles may be used with J-model wall cases provided a J-model adapter kit is also used to ensure proper airflow.

Read these instructions completely and carefully.



GE Kit Numbers

Use GE Kit Number:	For:	Description:
RAK56A100	GE RAB13, 14 & 15 (ACLB & RCL Chassis)	Fits all GE wall cases 26"W x 18"H x 24"D
RAK107	Hotpoint ACXB10 & 11 (ACTB Chassis)	Adapts an older Hotpoint wall case to a "J" model chassis. Fits Hotpoint wall cases 25 ³ / ₄ "W x 16 ⁷ / ₈ "H x 18 ⁵ / ₈ "D
RAK108	Whirlpool Type 23W Wall Case	Adapts Whirlpool wall case to a "J" model chassis. Fits Whirlpool wall cases 25 ⁷ / ₈ "W x 16 ¹ / ₂ "H x 23 ¹ / ₈ "D
RAK110	GE RAB30 ("F" models)	Adapts GE wall case to a "J" model chassis. Fits the RAB 30 wall case 26"W x 18"H x 24"D
RAK123	Fedders Wall Case "A"	Adapts Fedders wall case to a "J" model chassis. Fits Fedders wall cases 27"W x 16 ³ / ₄ "H x 16 ³ / ₄ "D
RAK126	Westinghouse Wall Case (Type 2626D73H01)	Adapts Westinghouse wall case to a "J" model chassis. Fits Westinghouse wall cases 25 ⁷ / ₈ "W x 15 ⁷ / ₁₆ "H x 16"D
RAK46, 47 & 48	Use these kits for all other brands not listed.	Standard wall case for "J" model chassis. RAG13 stamped aluminum exterior grille included. Remove the existing case and replace.
RAK690	RAB36, 37, 38, 46, 47 or 48 (J-Chassis)	If you attach a custom architectural outdoor grille, use this kit to ensure proper airflow.
RAG14E	RAB36, 37, 38, 46, 47 or 48 (J-Chassis)	Architectural louvered exterior grille

Safety Instructions

Operating Instructions

Care and Cleaning

Installation Instructions

Troubleshooting Tips

Consumer Support

Installing a J-Model in an existing wall case.

Read these instructions completely and carefully.

Install the Air Conditioner in the Case.

- A** Remove the locking plate on the front left side.

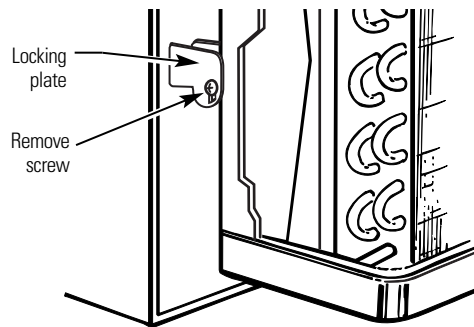

- B** Remove the shipping pad inside the air conditioner next to the compressor.

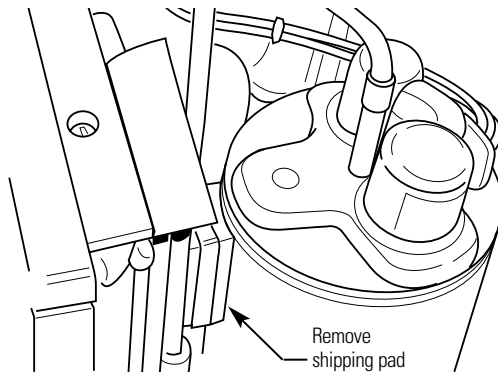

- C** Carefully slide the air conditioner back into the case. Make sure that the tubing on the unit does not touch the wall case and that the case installation is secure.

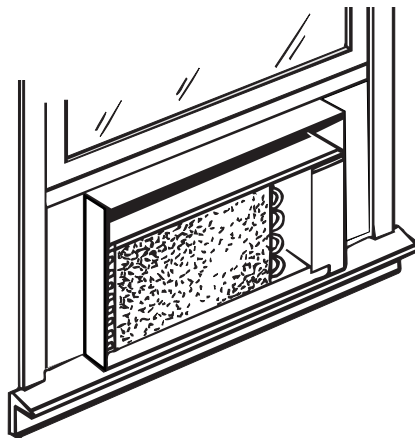

- D** Reinstall the locking plate with the tab behind the wall case flange. Tighten the screw.

- E** Attach the power cord to the base pan with the clamp.

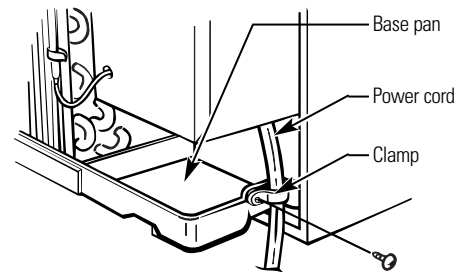

- F** When the wall outlet is to the left, extend the cord under the unit and hold it in place with the clamp.

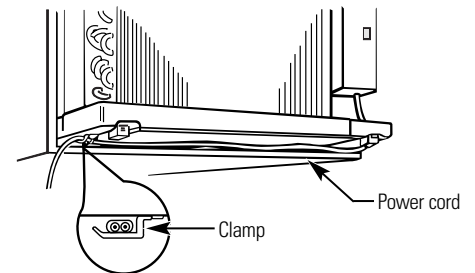

- G** Attach the front grille. An opening for the power cord is on the bottom of the front grille.

Notes.



A series of horizontal lines for taking notes, starting from the second line below the header and extending to the bottom of the page.

Safety Instructions

Operating Instructions

Care and Cleaning

Installation Instructions

Troubleshooting Tips

Consumer Support

Before You Call For Service...



Troubleshooting Tips
Save time and money! Review the chart on this page first and you may not need to call for service.

Problem	Possible Causes	What To Do
Air conditioner does not start	The air conditioner is unplugged.	<ul style="list-style-type: none"> • Make sure the air conditioner plug is pushed completely into the outlet.
	The fuse is blown/circuit breaker is tripped.	<ul style="list-style-type: none"> • Check the house fuse/circuit breaker box and replace the fuse or reset the breaker.
	Power failure.	<ul style="list-style-type: none"> • If power failure occurs, turn the mode control to OFF. When power is restored, wait 3 minutes to restart the air conditioner to prevent tripping of the compressor overload.
Air conditioner does not cool as it should	Airflow is restricted.	<ul style="list-style-type: none"> • Make sure there are no curtains, blinds or furniture blocking the front of the air conditioner.
	The temp control may not be set high or low enough.	<ul style="list-style-type: none"> • Turn the knob to a warmer or cooler setting. The coolest setting provides maximum cooling. The warmest setting provides maximum heating on models with heat.
	The air filter is dirty.	<ul style="list-style-type: none"> • Clean the filter at least every 30 days. See the <i>Care and cleaning of the air conditioner</i> section.
	The room may have been hot or cold.	<ul style="list-style-type: none"> • When the air conditioner is first turned on you need to allow time for the room to cool down or warm up.
	Cold air is escaping.	<ul style="list-style-type: none"> • Check for open furnace floor registers and cold air returns. • Set the air conditioner's vent to the closed position.
Air conditioner freezing up	Cooling coils have iced up.	<ul style="list-style-type: none"> • See "Air conditioner freezing up" below.
	Ice blocks the air flow and stops the air conditioner from cooling the room.	<ul style="list-style-type: none"> • Set the mode control at HIGH FAN or HIGH COOL with the temp at a warmer setting.

Normal Operating Sounds

- You may hear a pinging noise caused by water being picked up and thrown against the condenser on rainy days or when the humidity is high. This design feature helps remove moisture and improve efficiency.
- You may hear the thermostat click when the compressor cycles on and off.
- Water will collect in the base pan during high humidity or on rainy days. The water may overflow and drip from the outdoor side of the unit.
- The fan may run even when the compressor is not.

Air Conditioner Warranty.



All warranty service provided by our Factory Service Centers, or an authorized Customer Care® technician. To schedule service, on-line, 24 hours a day, contact us at www.GEAppliances.com, or call 800-GE-CARES.

Staple your receipt here. Proof of the original purchase date is needed to obtain service under the warranty.

For The Period Of:	GE Will Replace:
<p>One Year From the date of the original purchase</p>	<p>Any part of the air conditioner which fails due to a defect in materials or workmanship. During this full one-year warranty, GE will also provide, free of charge, all labor and in-home service to replace the defective part.</p>
<p>Five Years From the date of the original purchase</p>	<p>Any part of the sealed refrigerating system (the compressor, condenser, evaporator and all connecting tubing) which fails due to a defect in materials or workmanship. During this additional four-year limited warranty, GE will also provide, free of charge, all labor and in-home service to replace the defective part.</p>

What GE Will Not Cover:

- Service trips to your home to teach you how to use the product.
- Improper installation. If you have an installation problem, or if the air conditioner is of improper cooling capacity for the intended use, contact your dealer or installer. You are responsible for providing adequate electrical connecting facilities.
- Failure of the product resulting from modifications to the product or due to unreasonable use including failure to provide reasonable and necessary maintenance.
- In commercial locations labor necessary to move the unit to a location where it is accessible for service by an individual technician.
- Replacement of house fuses or resetting of circuit breakers.
- Failure due to corrosion on models not corrosion-protected.
- Damage to the product caused by improper power supply voltage, accident, fire, floods or acts of God.
- Incidental or consequential damage caused by possible defects with this air conditioner.

This warranty is extended to the original purchaser and any succeeding owner for products purchased for home use within the USA. In Alaska, the warranty excludes the cost of shipping or service calls to your home.

Some states do not allow the exclusion or limitation of incidental or consequential damages. This warranty gives you specific legal rights, and you may also have other rights which vary from state to state. To know what your legal rights are, consult your local or state consumer affairs office or your state's Attorney General.

Warrantor: General Electric Company, Louisville, KY 40225

Safety Instructions

Operating Instructions

Care and Cleaning

Installation Instructions

Troubleshooting Tips

Consumer Support

Consumer Support.



GE Appliances Website

www.GEAppliances.com

Have a question or need assistance with your appliance? Try the GE Appliances Website 24 hours a day, any day of the year! For greater convenience and faster service, you can now download Owner's Manuals, order parts, catalogs, or even schedule service on-line. You can also "Ask Our Team of Experts™" your questions, and so much more...



Schedule Service

www.GEAppliances.com

Expert GE repair service is only one step away from your door. Get on-line and schedule your service at your convenience 24 hours any day of the year! Or call 800-GE-CARES (800-432-2737) during normal business hours.



Real Life Design Studio

www.GEAppliances.com

GE supports the Universal Design concept—products, services and environments that can be used by people of all ages, sizes and capabilities. We recognize the need to design for a wide range of physical and mental abilities and impairments. For details of GE's Universal Design applications, including kitchen design ideas for people with disabilities, check out our Website today. For the hearing impaired, please call 800-TDD-GEAC (800-833-4322).



Extended Warranties

www.GEAppliances.com

Purchase a GE extended warranty and learn about special discounts that are available while your warranty is still in effect. You can purchase it on-line anytime, or call 800-626-2224 during normal business hours. GE Consumer Home Services will still be there after your warranty expires.

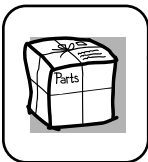

Parts and Accessories

www.GEAppliances.com

Individuals qualified to service their own appliances can have parts or accessories sent directly to their homes (VISA, MasterCard and Discover cards are accepted). Order on-line today, 24 hours every day or by phone at 800-626-2002 during normal business hours.

Instructions contained in this manual cover procedures to be performed by any user. Other servicing generally should be referred to qualified service personnel. Caution must be exercised, since improper servicing may cause unsafe operation.



Contact Us

www.GEAppliances.com

If you are not satisfied with the service you receive from GE, contact us on our Website with all the details including your phone number, or write to: General Manager, Customer Relations
GE Appliances, Appliance Park
Louisville, KY 40225



Register Your Appliance

www.GEAppliances.com

Register your new appliance on-line—at your convenience! Timely product registration will allow for enhanced communication and prompt service under the terms of your warranty, should the need arise. You may also mail in the pre-printed registration card included in the packing material, or detach and use the form in this Owner's Manual.