

Use and Care Guide



KitchenAid^{*}

Table of Contents (complete)	2
A Note to You	3
Oven Safety	4-5
Getting to Know Your Oven	6
Using Your Oven	7
Using EASY CONVECT* Conversion	29
Caring for Your Oven	44
Using the Self-Cleaning Cycle	47
Troubleshooting	52
Requesting Assistance or Service in the U.S.A. ..	54
Requesting Assistance or Service in Canada ...	55
Index	58
Warranty	60

In the U.S.A. for assistance or service,
call the Consumer Assistance Center:

1-800-422-1230

In Canada for assistance
or service, see page 3.

KITCHENAID^{*} Electric Built-In THERMAL-CONVECTION^{*} Ovens

Models: KEBS278D KEBS207D KEBS277D KEBS247D
KEBS208D KEBS107D KEBS177D KEBS147D

Table of Contents

A Note to You	3	Caring for Your Oven	44
Oven Safety	4-5	Cleaning your oven and controls	44
Getting to Know Your Oven	6	Removing the oven door	45
Using Your Oven	7	Using and replacing the oven lights ...	46
Using the electronic oven control	7	Using the Self-Cleaning Cycle	47
Oven settings	12	Before you start	47
Setting the clock	14	Before setting the controls	48
Using the timer	15	Setting the controls	48
Baking or convection baking	16	For best cleaning results	51
Convection roasting	18	How the cycle works	51
Cooking tips	20	Troubleshooting	52
Adjusting oven temperature	22	Requesting Assistance or Service	
Using the temperature probe	23	in the U.S.A.	54
Using convect full meal	26	Requesting Assistance or Service	
Using EASY CONVECT*		in Canada	55
Conversion	29	Index	58
Broiling	31	Warranty	60
Convection broiling	34		
Timed cooking	36		
Dehydrating	41		
Raising bread	42		
The oven vent(s)	43		

A Note to You

Thank you for buying a KITCHENAID* appliance!

KITCHENAID designs the best tools for the most important room in your house. To ensure that you enjoy many years of trouble-free operation, we developed this Use and Care Guide. It contains valuable information concerning how to operate and maintain your new appliance properly and safely. Please read it carefully.

Also, please complete and mail the enclosed Product Registration Card (U.S.A. or Canadian, whichever applies to you).

In the U.S.A.

For assistance or service

Call the Consumer Assistance Center toll-free **1-800-422-1230**

Throughout Canada for assistance

Call the Consumer Assistance Center toll-free **1-800-461-5681**
8:30 a.m. – 6 p.m. (EST)

Throughout Canada for service

Call toll-free **1-800-807-6777**
8 a.m. – 6 p.m. (EST)

If you need assistance or service, first see the "Troubleshooting" section of this book. After checking "Troubleshooting," additional help can be found by checking the "Requesting Assistance or Service" sections, or by calling one of the telephone numbers above.

When calling, you will need to know your appliance's complete model number and serial number. You can find this information on the model and serial number plate (see diagram on page 6).

Keep this book and the sales slip together in a safe place for future reference. You must provide proof of purchase or installation date for in-warranty service.

Model Number _____

Builder/Dealer Name _____

Serial Number _____

Address _____

Date Installed _____

Phone _____

Oven Safety

Your safety is important to us.

This guide contains safety statements under warning symbols. Please pay special attention to these symbols and follow any instructions given. Here is a brief explanation of the use of the symbol.



This symbol alerts you to hazards such as fire, electrical shock, or other injuries.

IMPORTANT SAFETY INSTRUCTIONS

WARNING

To reduce the risk of fire, electrical shock, injury to persons, or damage when using the oven, follow basic precautions, including the following:

General

- Read all instructions before using the oven.
- Install or locate the oven only in accordance with the provided Installation Instructions. The oven must be installed by a qualified installer. The oven must be properly connected to electrical supply and grounded.
- **CAUTION:** Do not store things children might want above the oven. Children could be burned or injured while climbing on it.
- Do not leave children alone or unattended in area where the oven is in use. They should never be allowed to sit or stand on any part of the oven. They could be burned or injured.
- Do not operate the oven if it is damaged or not working properly.
- Do not use the oven for warming or heating the room. Persons could be burned or injured, or a fire could start.
- Use the oven only for its intended use as described in this manual.
- Do not touch heating elements or interior surfaces of oven. Heating elements may be hot even though they are dark in color. Interior surfaces of an oven become hot enough to cause burns. During and after use, do not touch, or let clothing or other flammable materials contact heating elements or interior surfaces of oven until they have had sufficient time to cool. Other surfaces of the oven, such as the oven vent opening, the surface near the vent opening, and the oven door and window, could also become hot enough to cause burns.
- Do not wear loose or hanging garments when using the oven. They could ignite if they touch a hot heating element and you could be burned.
- Use only dry pot holders. Moist or damp pot holders on hot surfaces could result in burns from steam. Do not let pot holder touch hot heating elements. Do not use a towel or bulky cloth for a pot holder. It could catch on fire.
- Keep oven vents unobstructed.

- Do not heat unopened containers. They could explode. The hot contents could cause burns and container particles could cause injury.
- Use only cookware approved for oven use. Follow cookware manufacturer's instructions, especially when using glass or plastic cookware.
- Do not store flammable materials on or near the oven. The fumes could create an explosion and/or fire hazard.
- Do not repair or replace any part of the oven unless specifically recommended in this manual. All other servicing should be referred to a qualified technician.
- Disconnect the electrical supply before servicing the oven.

When using the oven

- Do not use water on grease fires. Never pick up a flaming pan. Smother flaming pan by covering with a well-fitting lid, cookie sheet, or flat tray. Flaming grease outside of pan can be extinguished with baking soda or, if available, a multipurpose dry chemical or foam-type extinguisher.
- Always position oven rack(s) in desired location while oven is cool. If a rack must be removed while oven is hot, do not let pot holder contact hot heating elements in oven.
- Use care when opening oven door. Let hot air or steam escape before removing or replacing food.

Care and cleaning

- Small amounts of formaldehyde and carbon monoxide are given off in the Self-Cleaning cycle from fiberglass insulation and food decomposition. Significant exposure to these substances can cause cancer or reproductive harm. Exposure can be minimized by venting with a hood or open window and wiping out excess food spills prior to self-cleaning.



- Do not use oven cleaners. No commercial oven cleaner or oven liner protective coating of any kind should be used in or around any part of the oven.
- Before self-cleaning the oven, remove broiler pan, broiler grid, oven racks, and other cookware. Do not use your oven to clean miscellaneous parts unless you are instructed to do so in this Use and Care Guide.
- Do not clean door gasket. It is essential for a good seal. Care should be taken not to rub, damage, or move the gasket. Clean only parts recommended in this Use and Care Guide.

– SAVE THESE INSTRUCTIONS –

Getting to Know Your Oven

This section tells you what features your oven has and where they are located. Please review this information before using your oven. To help you find information on specific parts or features quickly, page references are included.

Feature locations (Models KEBS208D and KEBS278D shown)

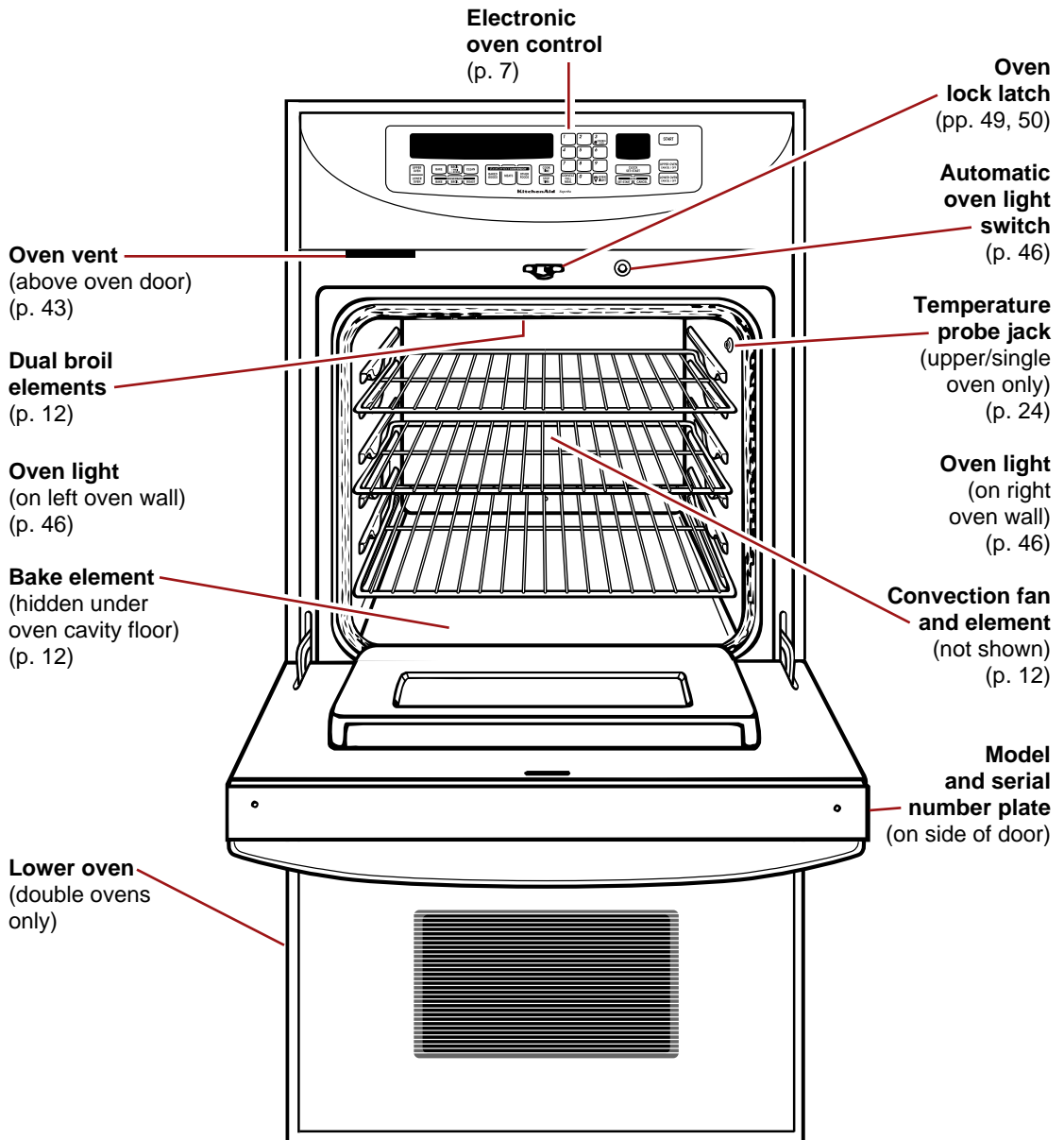

Using Your Oven

This section tells you, step by step, how to operate all oven functions controlled by the electronic control. Carefully follow these instructions, along with the cooking tips, for successful use of your oven.

NOTE: Displays and command pads shown are from double upper ovens. In some cases, lower oven and single oven displays and command pads may look different than those shown.

Using the electronic oven control (double thermal-convection oven shown)

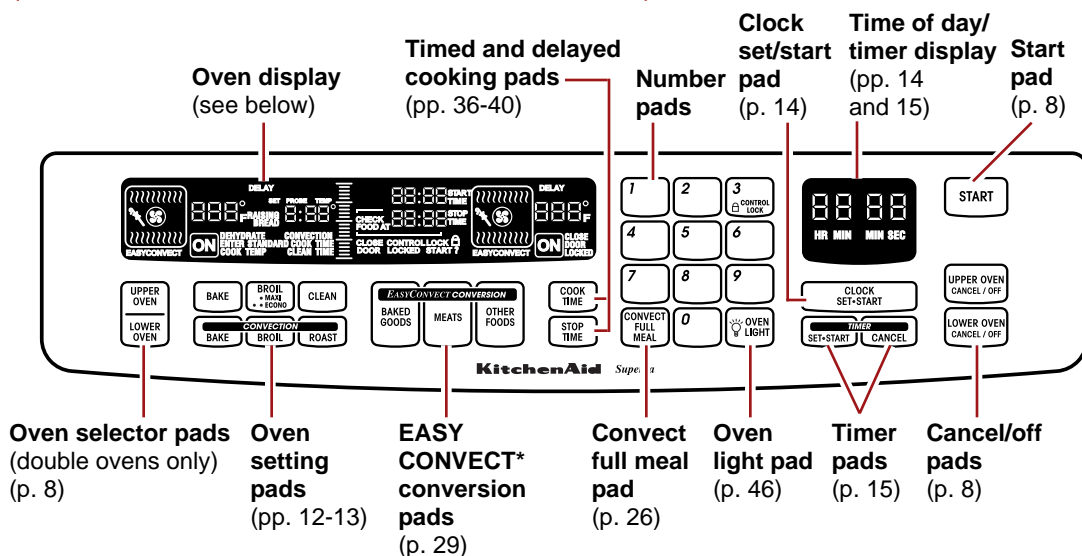

Display/clock

- When you first plug in the oven, a tone will sound, the display will be fully lit for a few seconds, and the display will show the last time set and "PF" (power failure). If, after you set the clock (page 14), the display again shows "PF", your electricity was off for a while. Reset the clock.
- The display will show "Err" and three short tones will sound if a time or temperature is incorrectly entered.

To set your oven to cook in Celsius instead of Fahrenheit:

PRESS and hold for 5 seconds



You will know you are in Celsius when "F" disappears. To switch back to Fahrenheit, press and hold BROIL again for 5 seconds. ("F" will reappear.)

If you need to convert temperatures from Celsius to Fahrenheit or vice versa, you can refer to this chart:

Temperature replacement values

38°C-100°F	163°C-325°F
60°C-140°F	177°C-350°F
66°C-150°F	191°C-375°F
77°C-170°F	204°C-400°F
93°C-200°F	218°C-425°F
121°C-250°F	232°C-450°F
135°C-275°F	246°C-475°F
149°C-300°F	260°C-500°F



Using Your Oven

Starting an operation

After programming a function, you must

START press the Start pad to start the function. If you do not press the Start pad within 5 seconds of programming, "START?" will show on the display as a reminder.

Canceling an operation

The Cancel/Off pad will cancel any function, except for the Clock and Timer functions. When you press the Cancel/Off pad, the small display will show the time of day, or if Timer is also being used, the time remaining.

NOTE: To cancel the timer see page 16.



(double ovens)

NOTE: You may hear a fan blowing in the oven even after you press the Cancel/Off pad. This is the cooling fan. It will turn off when the oven cools.

Changing audible signals

Audible signals tell you if a function is entered correctly or not. They also tell you when a cycle is completed.

To change pitch and loudness of key tone:

PRESS and hold for 5 seconds

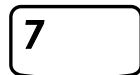

A short tone will sound and "Snd" and "Hi" or "Lo" will appear on the display. Repeat the step above to change to the other setting.

To turn on and off end-of-cycle tones and reminder tones (single or double ovens):

PRESS and hold for 5 seconds



To turn on and off all reminder tones (single or double ovens):

PRESS and hold for 5 seconds



To turn on and off all tones (double ovens)/to turn on and off key pad entry tones (single ovens):

PRESS and hold for 5 seconds



A short tone will sound and "Snd" and "On" or "OFF" will appear on the display to tell you the signals have been changed. Repeat the step above to turn the signals back on.

Selecting an oven

(double ovens)

To choose the oven you want to use, press the Upper Oven or Lower Oven pad.

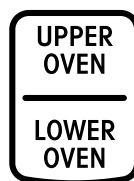

Finding out which oven is in use

(on double ovens)

Press the Upper Oven or Lower Oven pad.

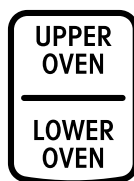

Upper oven or lower oven information will be displayed and the outer oven cavity symbol for the oven being programmed will flash.

Using the control lock

The control lock prevents unwanted use of the oven by disabling the control panel command pads.

NOTES:

- **On double ovens**, control lock is only available when oven is not active or set. On single ovens, control lock is available when oven is active, but it is not available only during the Self-Cleaning cycle or the Sabbath mode.
- **On single ovens**, the Cancel/Off pad will still work during control lock, but you will need to press it for 1 second.
- **On both single and double ovens**, the control lock will not disable the Timer. On double ovens, the light, timer, and clock are still available during control lock.
- **Set control lock** when cleaning the control panel to prevent oven from accidentally turning on.

To lock the control panel:

Press and hold the Control Lock pad (Number Pad 3) for 5 seconds. A single tone will sound and "CONTROL LOCK 



To unlock the control panel:

Press and hold the Control Lock pad (Number Pad 3) for 5 seconds. A single tone will sound after 5 seconds and "CONTROL LOCK 



Prompt for start

If "START?" is lit, this means that the Start pad has not been pressed. If you do not press the Start pad, the programmed function will automatically be canceled in 5 minutes.

Setting your single oven for the Sabbath[†]

If you want to set your oven to meet "no work" requirements for the Sabbath, follow these steps:

1. **Turn** the oven light on or off, as desired, by pressing the Oven Light pad. The oven light will stay turned on or off, whichever you chose, while in the Sabbath mode. Opening the door will not switch the oven light throughout the Sabbath mode.
2. **Press** BAKE.



3. **Press** Number Pads to set the temperature you want.

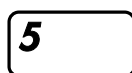
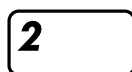

(example for 325°F)

4. **Press** START.



5. **Press and hold** Number Pad 6 for 5 seconds to go into the Sabbath mode.

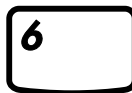

NOTE: The Sabbath mode is only available with the Bake function. Before going into the Sabbath mode make sure the timer is off. Also, make sure you are in an untimed Bake mode with no cook time or stop time specified.

[†] Star K certification pending. Full certification by Star K is expected near the end of 1996 or early 1997. Information is accurate as of 5/96.



Using Your Oven

What your oven will do while in the Sabbath mode:

- **The oven** will not shut off automatically.
- **The temperature displays** of the active ovens will show “Sab”.
- **To prevent accidental key pad presses**, only the 0-9, Start, Upper Oven, and Lower Oven key pads will work. (The Cancel/Off pad will also work, but it must be pressed 1 second longer.)
- **No tones** will sound.
- **No prompts**, error messages, or temperature changes will be displayed.
- **The ON Indicator Light** will light up when the oven is heating and will go off when the oven stops heating.

NOTE: If you open the oven door when the elements are off, the elements will not turn on. Elements will not turn on immediately after the door is closed. If you open the oven door when the elements are on, the elements will turn off after a delay. Again, elements will not turn on immediately after the door is closed.

To change the temperature during the Sabbath mode for holidays:

1. **Press** a Number Pad and hold for 2 seconds for the desired temperature. Each Number Pad is programmed for a specific set temperature:

NUMBER PAD	SET TEMPERATURE
1	170°F (77°C)
2	200°F (93°C)
3	250°F (121°C)
4	275°F (135°C)
5	300°F (149°C)
6	325°F (163°C)
7	350°F (177°C)
8	375°F (191°C)
9	400°F (204°C)
0	450°F (232°C)

2. **Press** START and hold for 2 seconds.



NOTE: It may take the oven up to one half hour to reach the desired temperature.

To end the Sabbath mode:

- **Press and hold** Number Pad 6 for 5 seconds.



If a power failure occurs during the Sabbath mode:

The oven will automatically return to the Sabbath mode at the desired temperature when power returns.

Setting your double oven for the Sabbath†

If you want to set your oven to meet “no work” requirements for the Sabbath, follow these steps:

1. **Press** BAKE.



2. **Press** Number Pads to set the temperature you want.



(example for 325°F)

3. **Press** START.



† Star K certification pending. Full certification by Star K is expected near the end of 1996 or early 1997. Information is accurate as of 5/96.



4. Press and hold Number Pad 6 for 5 seconds to go into the Sabbath mode.

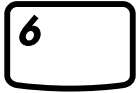

NOTES:

- **The Sabbath mode** is only available with the Bake function.
- **The Timer** will be canceled in the Sabbath mode.
- **To use both ovens in the Sabbath mode**, both ovens must be in BAKE mode before going into the Sabbath mode. If only one oven is on before entering the Sabbath mode, then the other oven cannot be turned on while in the Sabbath mode.

What your oven will do while in the Sabbath mode:

- **The oven** will not shut off automatically.
- **The temperature displays** of the active ovens will show “Sab”.
- **To prevent accidental key pad presses**, only the 1-9, Start, Upper Oven, and Lower Oven key pads will work.
- **Oven lights** will stay off. Lights will not turn on when door is opened.
- **The indicator** will flash for a few seconds to tell you when the elements are about to turn on or off.
- **No tones** will sound.
- **No prompts**, error messages, start times, or temperature changes will be displayed.
- **The Element Indicator light** will light up when the oven is heating and will go off when the oven stops heating.

NOTE: If you open the oven door when the elements are off, the elements will not turn on. Elements will not turn on immediately after the door is closed. If you open the oven door when the elements are on, the elements will turn off after a delay. Again, elements will not turn on immediately after the door is closed.

To change the temperature during the Sabbath mode for holidays:

1. **Press** upper/lower oven pad.
2. **Press** a Number Pad for the desired temperature. Each Number Pad is programmed for a specific set temperature:

NUMBER PAD	SET TEMPERATURE
1	170°F (77°C)
2	200°F (93°C)
3	250°F (121°C)
4	300°F (149°C)
5	325°F (163°C)
6	350°F (177°C)
7	375°F (191°C)
8	400°F (204°C)
9	475°F (246°C)

3. **Press** START.



NOTE: It may take the oven up to one half hour to reach the desired temperature.

To end the Sabbath mode and turn off oven:

- **Press and hold** Number Pad 6 for 5 seconds. (You only need to do this step once for both ovens.)



If a power failure occurs during the Sabbath mode:

The oven will automatically return to the Sabbath mode at the desired temperature when power returns.



Oven settings

This chart tells you when to use each setting. It also explains which elements heat up for each setting.

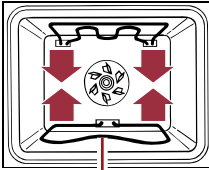
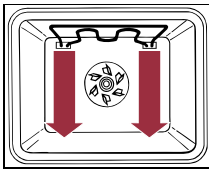
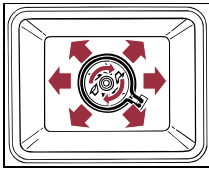
SETTING	DIAGRAM	SETTING INFORMATION
<p>BAKE Use this setting for standard baking and roasting.</p>	 <p>Bake element (not visible)</p>	<ul style="list-style-type: none"> • The bottom element and both top elements heat up. • The elements will turn on and off to maintain the oven temperature. • Opening the door during Bake will cause the broil elements to turn off immediately and the bake element to turn off after 2 minutes.
<p>BROIL (MAXI/ECONO) Use this setting for broiling regular-sized and smaller cuts of meat, poultry, and fish.</p>		<ul style="list-style-type: none"> • Both top elements heat during Maxi Broil. (Maximum browning coverage.) • Only the inner element heats up during Econo Broil. (Browning coverage in center only.) • The elements will turn on and off to maintain the oven temperature. • Opening the door during Broil will cause the broil elements to turn off immediately.
<p>CONVECTION BAKE Use this setting for delicate foods and for baking breads and cakes. Use also when baking large quantities of food on more than one oven rack.</p>		<ul style="list-style-type: none"> • For faster preheating, the bottom element and both top elements heat up until oven reaches desired temperature. After preheat, only the rear element heats up (and in some models the bottom element heats up). • For even heating, the fan at the back of the oven circulates air in the oven cavity. • The elements will turn on and off to maintain the oven temperature. • Opening the door during Convection Bake will cause the broil elements, convection fan, and rear element to turn off immediately. The bake element will turn off after 2 minutes.

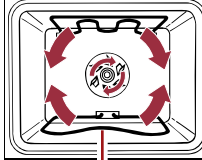
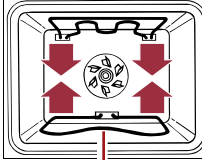

SETTING	DIAGRAM	SETTING INFORMATION
<p>CONVECTION BROIL Use this setting for broiling thick cuts of meat.</p>		<ul style="list-style-type: none"> • Both top elements heat up. • For even heating, the fan at the back of the oven circulates air in the oven cavity. • The elements will turn on and off to maintain the oven temperature. • Opening the door during Convection Broil will cause the broil elements and convection fan to turn off immediately.
<p>CONVECTION ROAST Use this setting for roasting and baking on one rack.</p>	 <p>Bake element (not visible)</p>	<ul style="list-style-type: none"> • The bottom element and both top elements heat up. • For even heating and faster cooking, the fan at the back of the oven circulates air in the oven cavity. • The elements will turn on and off to maintain the oven temperature. • Opening the door during Convection Roast will cause the broil elements and convection fan to turn off immediately. The bake element will turn off after 2 minutes.
<p>CLEAN Use this setting for self-cleaning only.</p>	 <p>Bake element (not visible)</p>	<ul style="list-style-type: none"> • The bottom element and both top elements heat up.



Setting the clock

NOTE: These examples are for double upper ovens only. Other ovens may look slightly different.

NOTE: If a timed oven function is active or programmed, you cannot change the clock. If an untimed oven function is active or programmed, you can change the clock, however the start time will disappear.

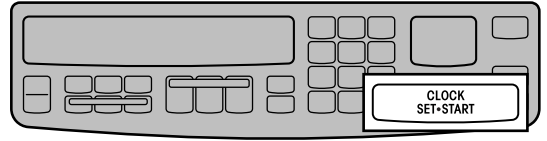

1. Press Clock Set/Start pad.

PRESS



YOU SEE

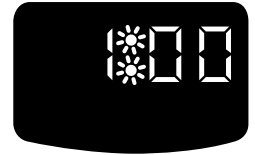

(last time of day on display) (colon is flashing)

2. Set time.

PRESS

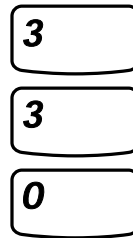

YOU SEE

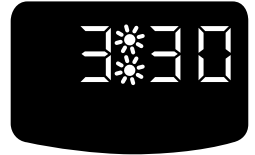

3. Start clock.

If time has not been entered correctly, three short tones will sound and "Err" will be displayed. The display will show the last valid time to appear on the display. Repeat Steps 2 and 3 to re-enter the time of day.

PRESS



YOU SEE



To disable the display clock:

You can clear the time of day from the display by pressing and holding CLOCK SET/START for 5 seconds. Repeat to see time of day on display again.

Using the timer

The Timer does not start or stop the oven. It works like a regular kitchen timer. It can be set in hours and minutes up to 99 hours, 59 minutes, or in minutes and seconds up to 99 minutes, 99 seconds.

NOTE: These examples are for double upper ovens only. Other ovens may look slightly different.

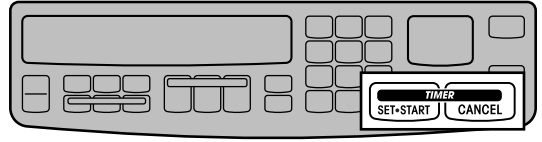

1. Press Timer Set/Start pad.

- **Once** to set hours and minutes
- **Twice** to set minutes and seconds

PRESS



YOU SEE

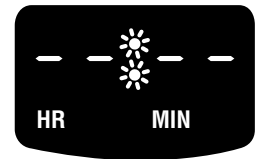

(example shows hours and minutes timer setting 1)

2. Set time.

PRESS

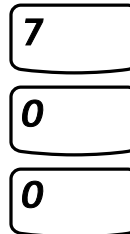

YOU SEE



(example shows a 7-hour timer setting)

3. Start Timer.

The Timer will begin counting down immediately after you press the Timer Set/Start pad.

PRESS



YOU SEE

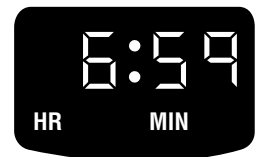

4. When time is up, turn off Timer.

When time is up, you will hear four tones unless end-of-cycle tone is disabled. (See page 8.) Press the Timer Cancel pad to clear the display. Also, four tones will sound every minute as an audible reminder unless they are disabled. (See page 8.)

YOU SEE





To change the timer during its operation:

1. Press Timer Set/Start pad.
2. Enter new desired time.
3. Press Timer Set/Start pad.

To cancel the timer during its operation:

You can cancel the Timer any time during its operation. Press the Timer Cancel pad.

PRESS



Baking or convection baking

NOTES:

- **These examples** are for double upper ovens only. Other ovens may look slightly different.
- **If you need** to convert temperatures from Celsius to Fahrenheit or vice versa, see page 7.

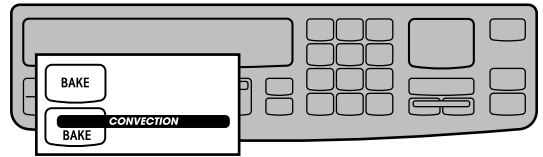

1. Position racks.

For correct rack placement, see “Rack placement” chart on page 20.

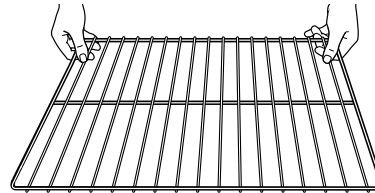

Your upper/single oven has 3 flat racks and 5 rack positions. Your lower oven has either 2 or 3 racks (depending on model) and 5 rack positions. Rack position 5 is the highest position, or farthest from the bottom of the oven. Rack position 1 is the lowest position, or closest to the bottom of the oven.

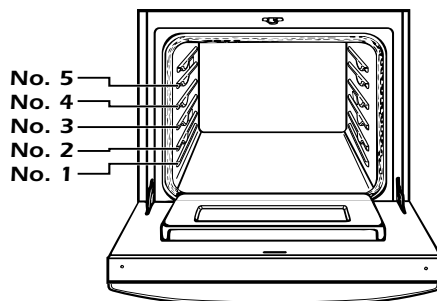

NOTES:

- **Before turning oven on**, place oven racks where you need them.
- **Be sure** the rack(s) is level.
- **Use pot holders or oven mitts** to protect your hands, if rack(s) must be moved while oven is hot.
- **Do not let** pot holder or oven mitt touch oven bottom.
- **See pages 20 and 21** for additional baking and convection baking tips.



2. Choose baking setting.

NOTE: On double ovens, the cavity symbol flashes to tell you which oven you are setting.

PRESS



to select oven
(for double ovens)

PRESS



OR

PRESS



to select oven
(for double ovens)

PRESS



YOU SEE

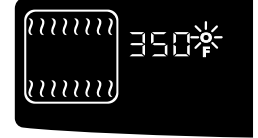

(or 177°C)

YOU SEE



(or 149°C)

3. Set temperature (optional).

Do this step if you want to set a temperature other than 350°F for Bake or 300°F for Convection Bake.

NOTE: See a reliable cookbook or your convection oven cookbook for temperature recommendations.

PRESS

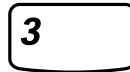

YOU SEE

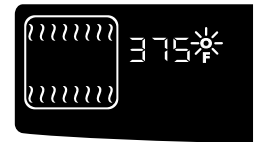

(example for Bake
at 375°F)

continued on next page



4. Preheat oven.

After the temperature reaches 170°F, the temperature display will show the actual oven temperature at each 5°F (3°C) increase. It will then stop at the set temperature. One long tone will sound when oven is preheated.

PRESS



YOU SEE

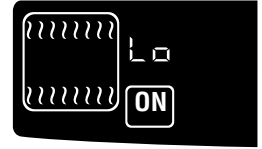

(example for Bake)
("Lo" is displayed after 5 seconds if oven temperature is below 170°F)

5. Put food in oven.

NOTE: If you want to change the baking temperature after baking has begun, repeat Steps 2, 3, and 4.

6. After cooking, turn off oven.

PRESS



(single ovens)

OR



(double ovens)

YOU SEE

(display will go blank)

Convection roasting

NOTE: These examples are for double upper ovens only. Other ovens may look slightly different.

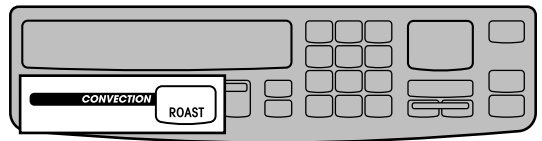

1. Prepare oven.

Position the rack properly. For correct rack placement, see "Baking or convection baking" on page 16. Place food in the oven. For large roasts and turkeys, place rack in position 1 or 2. (Preheating is not necessary when roasting.)

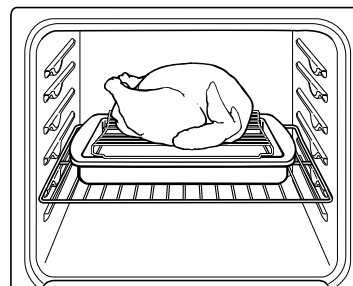

2. Choose setting.

NOTE: On double ovens, the cavity symbol flashes to tell you which oven you are setting.

PRESS



to select oven (for double ovens)

YOU SEE

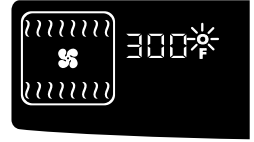

(or 149°C)

PRESS



3. Set temperature (optional).

Do this step if you want to set a temperature other than 300°F.

NOTE: See your convection oven cookbook for temperature recommendations.

PRESS



YOU SEE

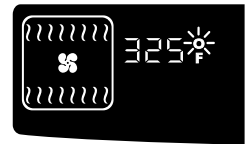

(example shows 325°F temperature setting)

4. Start oven.

NOTES:

- After the temperature reaches 170°F, the temperature display will show the actual oven temperature at each 5°F (3°C) increase. It will then stop at the set temperature.
- If you want to change the roasting temperature after roasting has begun, repeat Steps 2, 3, and 4.

PRESS



YOU SEE

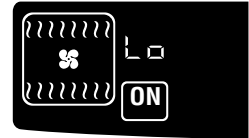

("Lo" is displayed after 5 seconds if oven temperature is below 170°F)

5. After cooking, turn off oven.

PRESS



(single ovens)

OR



(double ovens)

YOU SEE

(display will go blank)



Cooking tips

Baking/convection baking tips

The hot air must circulate around the pans in the oven for even heat to reach all parts of the oven. This results in better baking.

For best air circulation:

- Place the pans so that one is not directly over the other.



- For best results, allow 1 1/2 to 2 inches of space around each pan and between pans and oven walls.
- When baking with one pan, place pan in the center of the oven rack.

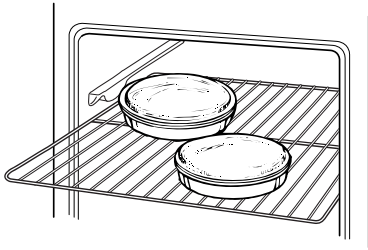

- When baking with two pans, place pans in opposite corners of the oven rack.

NOTE: “Oven peeking” may cause heat loss, longer cooking times, and unsatisfactory baking or roasting results. Rely on your timer.

Baking tips

(Bake pad)

For proper cooking, follow these guidelines:

- When using one rack, place the rack so the top of the food will be centered in the oven.
- When using more than one rack, use the Convection Bake setting.
- Use only one cookie sheet in the oven at a time when using the Bake setting.

Rack placement for specific foods:

FOOD	RACK POSITION
Frozen pies	2
Angel food and bundt cakes, most quick breads, yeast breads, casseroles, meats	1 or 2
Cookies, biscuits, muffins, cakes, nonfrozen pies	2 or 3

NOTE: See “Baking or convection baking” on page 16 for additional baking tips.

Bakeware tips

- When baking with insulated cookie sheets or baking pans, place them in the bottom third of the oven. You may need to increase the recommended baking times, so test for doneness before removing from the oven.
- When using ovenproof glassware or dark bakeware, reduce the oven temperature by 25°F, but use the same baking time. Because these pans absorb heat, producing darker bottom browning and crispier crusts, place the rack in the center of the oven. When baking pies and bread, you can use the temperature called for in the recipe.

Using aluminum foil in the oven

(for thermal baking)

Use aluminum foil to catch spillovers from pies or casseroles.

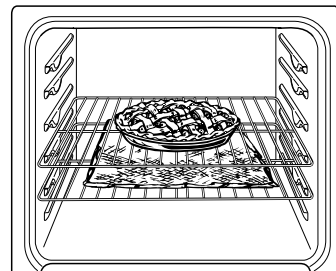

- Place the foil on the oven rack below the rack with the food. Turn foil edges up and make sure foil is about 1 inch (3 cm) larger all around than the dish holding the food.



- **Do not cover** the entire rack with aluminum foil. It will reduce air circulation and cause poor cooking results.

NOTE: Do not line oven bottom with foil or other liners. It could affect the quality of your baking.

Convection baking tips (Convection Bake pad)

- **Do not use** aluminum foil when convection baking. Aluminum foil may block airflow.
- **Reduce** recommended recipe oven temperature by approximately 25°F. Use EASY CONVECT* Conversion (see page 29).
- **For some recipes**, you can reduce convection baking time compared to standard baking times. Use EASY CONVECT Conversion (see page 29).

NOTE: Cooking time may be longer when you use more than one rack.

- **When baking on two or three racks**, use the Convection Bake setting for more even results. (You can, however, use only one rack when convection baking.)

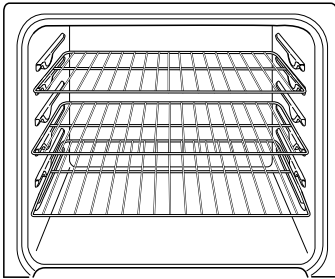

- **To use three racks during convection baking**, place one rack in position 5 (the highest position), another rack in position 1 (the closest to the oven bottom), and the third rack in position 3. This allows all three racks to be an equal distance apart for better baking.
- **Stagger** cake pans or other utensils in opposite directions on each rack when three racks are used. This will make sure pans are not directly over each other.

NOTE: See “Baking or convection baking” on page 16 for additional convection baking tips.

Roasting tips

- **Spatter can be reduced** by lining the bottom of the roasting pan with lightly crushed aluminum foil.
- **Use an accurate meat thermometer or temperature probe** (see page 23) to determine when meat has reached desired degree of doneness. Insert the thermometer or probe into the center of the thickest portion of the meat or inner thigh or breast of poultry. For an accurate reading, the tip of the thermometer or probe should not touch fat, bone, or gristle.
- **After reading the thermometer once**, push it further into the meat ½ inch or more and read again. If the temperature drops, return the meat to the oven for more cooking.
- **Check pork and poultry** with a thermometer in 2-3 places to ensure adequate doneness.
- **Poultry and roasts will be easier to carve** if loosely covered with foil and allowed to stand 10-15 minutes after removal from the oven.
- **You can reduce** roasting times and temperatures for most standard recipes when using the Convection Roast setting. See convection roasting chart in your convection oven cookbook for recommended roasting times and temperatures, or use EASY CONVECT Conversion (see page 29).

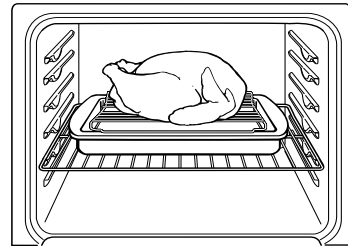

- **Use the convection roasting rack** on the broiler pan and grid (all included with your oven). (The convection roasting rack rests on the broiler pan and grid.) The long side of the rack should be parallel with the oven door for best heat distribution and airflow.



Adjusting oven temperature

Although your new oven is properly adjusted to provide accurate temperatures, it may cook faster or slower than your old oven.

If, after using the oven for a period of time, you are not satisfied with the baking/roasting results, you can change the offset temperature by following the steps below. The control will “remember” the selected offset even after the power has been interrupted or lost.

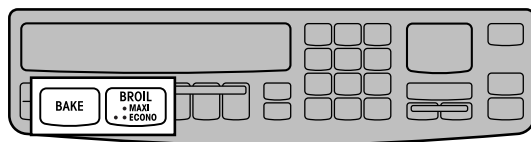

NOTES:

- **On double ovens**, upper and lower oven temperature may be adjusted independently. Press the Upper or Lower Oven pads.
- **DO NOT measure** oven temperature with a thermometer. Opening the oven door will affect the oven temperature and give you an inaccurate reading. Also, the thermometer temperature reading will change as your oven cycles.
- **These examples** are for double upper ovens only. Other ovens may look slightly different.

1. Press and hold Bake pad for 5 seconds.

Release the pad when a number and CAL appear on the temperature display and you hear a tone.

PRESS



to select oven (for double ovens)

YOU SEE



(factory setting of “0”)

PRESS



Hold for 5 seconds

2. Set new offset temperature.

You can set the offset temperature adjustment as low as -35°F (-21°C) or as high as +35°F (+21°C). Each time you press the Bake pad, the displayed temperature will increase by 5°F (3°C). Each time you press the Broil pad, the displayed temperature will decrease by 5°F (3°C). (To determine the amount of adjustment needed, see the chart on page 23.)

PRESS



OR



YOU SEE



(example when making oven 10°F [or 5°C] hotter)

NOTE: If there is no “F” after the temperature, you are in the Celsius mode.

3. Enter the adjustment.

NOTE: If you press the Cancel/Off pad instead of the Start pad, the offset temperature will stay the same.

PRESS



YOU SEE

(display will go blank)

How to determine the amount of adjustment needed

The following chart tells you how much to adjust the offset temperature to get the desired cooking results. You can determine cooking results by amount of browning, moistness, and rising times for baked foods.

TO COOK FOOD ...	ADJUST BY THIS NUMBER OF DEGREES
A little more	+5°F to +10°F/ +3°C to +6°C
Moderately more	+15°F to +20°F/ +8°C to +12°C
Much more	+25°F to +35°F/ +16°C to +21°C
A little less	-5°F to -10°F/ -3°C to -6°C
Moderately less	-15°F to -20°F/ -8°C to -12°C
Much less	-25°F to -35°F/ -16°C to -21°C

Using the temperature probe (upper/single oven only)

The Temperature Probe can be used when baking/roasting any type of meat or poultry, or cooking casseroles with liquid.

NOTES: These examples are for double upper ovens only. Other ovens may look slightly different.

NOTES:

- **Do not use** the Temperature Probe when broiling, convection broiling, dehydrating, or raising bread.
- **Unplug** the Temperature Probe before self-cleaning the oven.

1. Insert probe into food.

Insert at least $\frac{2}{3}$ of the probe into the center of the thickest portion of meat or into the inner thigh or breast of poultry, away from fat or bone.

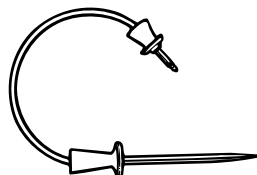
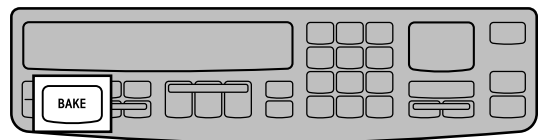



Using Your Oven

2. Put food in oven.

Place meat on the convection roasting rack, place rack on broiler pan and grid, and place pan in the center of the oven.

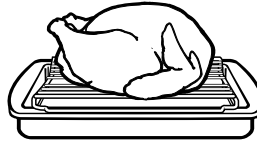

3. Connect probe to oven.

Insert the plug into the jack located on the right oven wall. (Keep the top of the probe as far as possible from the heat source.)

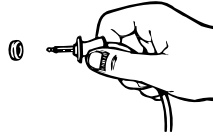

YOU SEE



(or 71°C) (on double ovens, the upper oven cavity symbol flashes to tell you which oven you are setting)

4. Close oven door.

5. Set temperature (optional).

Do this step if you want to set an internal food temperature (from 130°F-190°F) other than 160°F.

NOTE: See a reliable cookbook or your convection oven cookbook for internal food temperature recommendations.

PRESS



to select oven (for double ovens)

YOU SEE

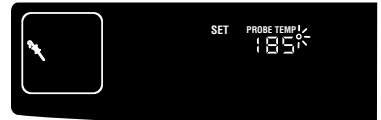

(example shows 185°F internal temperature setting)

PRESS



6. Choose cook setting.

- BAKE,
- CONVECTION BAKE, or
- CONVECTION ROAST

NOTE: If you press Clean, Cook Time, Stop Time, or Broil pads the display will show “pull prb out”.

PRESS



(example for Bake)

YOU SEE



7. Set temperature (optional).

Do this step if you want to set an oven temperature other than the one displayed.

NOTE: See a reliable cookbook or your convection oven cookbook for oven temperature recommendations.

PRESS

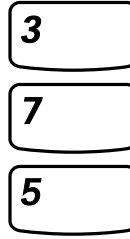

YOU SEE

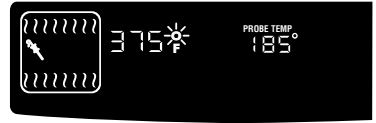

(example shows 375°F temperature setting)

8. Start oven.

NOTES:

- **If you do not choose** a cook setting and press START, the oven will default to bake at 350°F and start. If you want to cook with another setting or at another temperature, do Steps 6 and 7 and press START.
 - **The oven temperature display** will show the set oven temperature throughout temperature probe cooking.
 - **After the food temperature** reaches 130°F, the probe display will show the actual food temperature at each 5°F increase and stop at the set temperature. Four tones will sound (if tones are not disabled, see page 8) and “End” will show when food reaches the set temperature. The oven then shuts off.
 - **If you want to change** the probe temperature after cooking has begun:
 - Unplug the probe, then plug it back in. You will be prompted for a new probe temperature. Next, repeat Steps 5 and 8 in that order. You may also change the oven temperature at this point by pressing the desired cook setting pad again.
- OR**
- Press Start pad and repeat steps 5-8, in that order. You may also change the oven temperature at this point by pressing the desired cook setting pad again.

PRESS



YOU SEE



(example for Bake)

continued on next page



⚠ WARNING

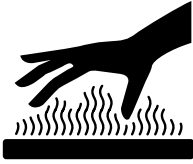

Burn Hazard

Use an oven mitt or pot holder to remove temperature probe.

Do not touch broil element.

Failure to follow these instructions can result in burns.

9. After cooking, unplug probe.

The probe symbol will remain lit until you unplug the Temperature Probe.

10. Remove food from oven.

(This prevents overcooking.)

11. Clean probe.

Wash with a soapy sponge and dry thoroughly. Use a plastic scouring pad to remove cooked-on foods. You can also clean the probe in a dishwasher.

Using convect full meal

(upper oven/single oven/both ovens on Models KEBS208D and KEBS278D)

Convect Full Meal lets you choose from among ten preset oven convection cooking cycles, all using the convection fan. These cycles store commonly used cooking times, cooking temperatures, and probe temperature settings. Convect Full Meal saves you time by limiting the number of pads you have to press when cooking a favorite cycle. Convect Full Meal also lets you set your own favorite cycle (either convection or nonconvection). On double ovens, you can set two favorite cycles, one for each oven.

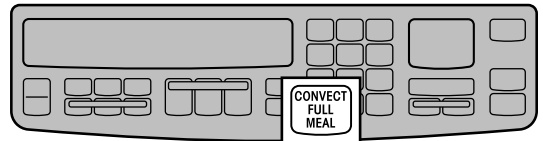

NOTE: These examples are for double upper ovens only. Other ovens may look slightly different.



1. Place food in cold oven.

If you need the Temperature Probe for your cycle (settings 6 thru 0 in chart on page 28), insert probe into food. Place food in oven and plug probe into jack.

2. Press Convect Full Meal pad.

PRESS



to select oven
(for double ovens)

YOU SEE



("C" stands for "cycle,"
"F" stands for "favorite")

PRESS



3. Press desired Number pad.

Use the "Convect full meal chart" on page 28 as your guide for selecting a cycle.

NOTES:

- **On double ovens**, the cavity symbol flashes to tell you which oven you are setting.
- **You can change** the Convect Full Meal cycle any time before pressing the Start pad by repeating Step 3.
- **You can program your own setting**, for each oven in double ovens, which you can then select in the future by pressing just upper/lower oven Convect Full Meal and START. (See page 28 for more information.)

PRESS



YOU SEE



(example for cycle 1)



4. Start oven.

PRESS



YOU SEE

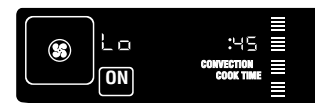

5. When the Convect Full Meal cycle is done:

Four tones will sound, followed by 4 reminder tones (unless they have been disabled), every minute until you open the door, remove the probe, or press the Cancel/Off pad.

YOU SEE



(double oven display)



Convect full meal chart

CYCLE NUMBER	CONVECTION CYCLE	OVEN TEMP	TIME OR PROBE TEMP	FOOD OR MEAL
1	Conv. Bake	325°F	1 hr	Meal#1: Spinach and ricotta stuffed meat loaf, Baked potatoes, Fall apple cake
2	Conv. Roast	325°F	1½ hrs	Meal#2: Pesto stuffed turkey breast, Caramel-sweet potato casserole, Rhubarb-pineapple crisp
3	Conv. Roast	350°F	40 min	Meal#3: Pork chops with currant-nut stuffing, Cherry cobbler
4	Conv. Bake	375°F	45 min	Meal#4: Herb and pecan fried chicken, Crispy potato wedges, Applesauce rhubarb muffins
5	Conv. Bake	425°F	20 min	Meal#5: Spicy red snapper, Gruyere pecan biscuits
6	Conv. Roast	325°F	140°F	Beef, rare
7	Conv. Roast	325°F	155°F	Beef, medium Pork
8	Conv. Roast	325°F	165°F	Beef, well done
9	Conv. Roast	300°F	135°F	Ham, fully cooked
0	Conv. Bake	325°F	160°F	Casseroles

To program your own cycle:

1. **Press** Upper/Lower Oven pad.
2. **Press** Convect Full Meal.
3. **Press** the Command Pad to the cook cycle you want (for example, BAKE).
4. **Enter** the temperature and cook time you want. (The default is Bake at 170°F for 2 hours.) Entering a cook time of 0 minutes lets you do untimed cooking.
5. **To save only, press** Convect Full Meal.
To cook with this cycle immediately and save it, press START.

NOTE: You can also program a Temperature Probe setting rather than a cook time in upper/single ovens. In double ovens you can program two separate favorite cycles, one for each oven.

When programming your own cycle:

1. **Start** with meat or main dish items (times are more critical with these items).
2. **Choose** baked goods with bake temperatures similar to those of meat or main dish items. Convection baking time of +/-10 to 15 minutes and temperatures of +/-25 to 50 degrees are acceptable.
3. **Choose** vegetables and fruits last.



Using EASY CONVECT* Conversion

(upper oven/single oven/both ovens on Models KEBS208D and KEBS278D)

EASY CONVECT Conversion lets you convection cook without entering convection cook temperatures and times. Simply enter the standard cook temperature and time for the food to be cooked. The oven will reduce the temperature, or the temperature and time, for convection cooking. (Convection temperatures and times are not as long because the heated air is circulated in the oven cavity for quicker cooking.)

NOTE: These examples are for double upper ovens only. Other ovens may look slightly different.

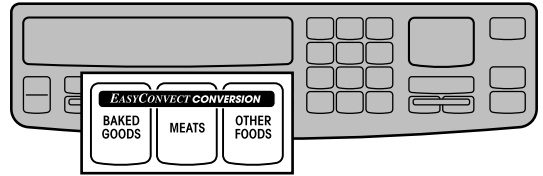

NOTE: The converted temperatures and times are not precise because the food categories you choose from are general. (See “EASY CONVECT Conversion setting chart” on page 31 for which foods you can cook in each setting.) To ensure proper cooking, the oven will prompt you to check food at the end of cook time. If food needs more cooking, the oven will continue to cook. If food does not need more cooking, press Cancel/Off pad.

1. Place food in oven.

NOTE: For Baked Goods and Other Foods, place food in the oven after the oven has been preheated.

2. Press one of three EASY CONVECT Conversion Pads.

Example for Meats:

NOTE: On double ovens, the cavity symbol flashes to tell you which oven you are setting.

PRESS



to select oven (for double ovens)

YOU SEE



PRESS



3. Enter standard cook temperature.

PRESS

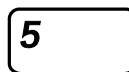
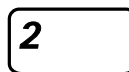
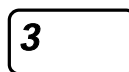

YOU SEE



(example showing 325°F – cooking without temperature probe)



4. Enter standard cook time.

NOTES:

- **This step** is not needed when using the temperature probe.
- **To delay convection cooking**, after Step 4, press the Stop Time pad and enter the desired stop time. Cooking will start at the time equal to the stop time less the cook time. (Example: A cook time of 1 hour and a stop time of 4:00 would give you a start time of 3:00.)

PRESS

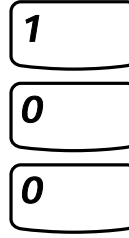

YOU SEE



(example showing 1 hour)

5. Start oven.

NOTES:

- **The actual temperature** reduction and time savings are different for each food category and oven type.
- **For Baked Goods and Other Foods**, place food in the oven after the oven has been preheated.

PRESS



YOU SEE



(display shows temperature reduced by 25°F – nondelayed cooking)

6. At end of cook time (nondelayed cooking):

YOU SEE



7. Open door and check food (nondelayed cooking).

If you want to continue cooking, close door and the oven will continue cooking. If you do not want to continue cooking, press the Cancel/Off pad.

YOU SEE

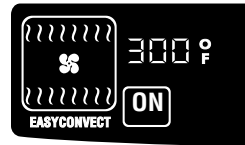

8. When stop time is reached (delayed cooking only):

Four tones will sound, followed by four reminder tones (unless they have been disabled), every minute until you open the door, remove the probe, or press the Cancel/Off pad.

YOU SEE



(double oven display)



EASY CONVECT* Conversion setting chart

EASY CONVECT SETTING	FOODS YOU CAN COOK WITH THIS SETTING
Baked Goods	Cakes: layer, angel food Breads: quick and yeast Biscuits and cookies Casseroles, including frozen entrees and soufflés, Fish
Meats	Chicken: whole and pieces Roasts: pork, beef, and ham Meat loaf, Baked potatoes NOTE: Turkey or large poultry are not included because their cooking times vary.
Other Foods	Convenience foods: french fries, nuggets, fish sticks, pizza Pies: fruit and custard

Broiling

NOTE: These examples are for double upper ovens only. Other ovens may look slightly different.

NOTE: Preheating is not necessary when broiling.

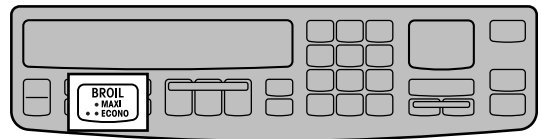

1. Position rack.

See “Broiling rack positions” on page 35 for recommended rack positions.

NOTES:

- **Before turning oven on**, place oven racks where you need them.
- **Be sure** the rack(s) is level.
- **Use pot holders or oven mitts** to protect your hands, if rack(s) must be moved while oven is hot.
- **Do not let** pot holder or oven mitt touch hot broil elements.
- **See “Broiling tips”** on page 35 for additional broiling tips.

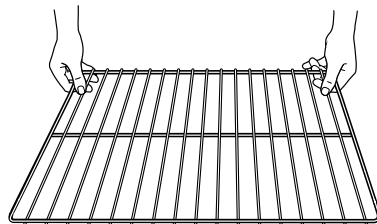

continued on next page



2. Put food in oven.

Place food on grid in broiler pan and place in center of the oven rack.

NOTES:

- **Place food** about 3" or more from the broil elements.
- **To ensure adequate grease drainage**, do not use cookie sheets or similar pans for broiling.
- **If foil is used** to cover broiler grid, cut slits in foil to allow grease to drain away.

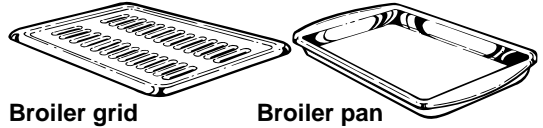

3. Close door.

NOTE: Do not keep the door open as on other electric ovens. Unlike other electric ovens, the broil elements will only stay on with the door closed. This gives you the high heat you need for broiling. However, if you leave the door open, the broil elements will go off.

4. Press Broil pad.

Once for Maxi Broil

OR

Twice for Econo Broil

NOTE: On double ovens, the cavity symbol flashes to tell you which oven you are setting.

PRESS



to select oven (for double ovens)

PRESS



YOU SEE

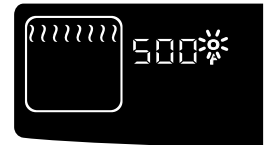

(or 260°C) (example for Maxi Broil)

PRESS



to select oven (for double ovens)

PRESS



YOU SEE



(or 260°C) (example for Econo Broil)



5. Set temperature (optional).

Do this step if you want to use variable temperature broiling (see below).

PRESS



YOU SEE

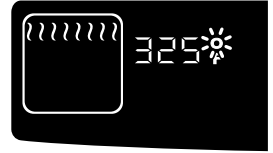

(example shows 325°F broiling temperature for Maxi Broil)

6. Start oven.

NOTE: If you want to change the broiling temperature after broiling has begun, repeat Steps 4, 5, and 6.

PRESS



YOU SEE

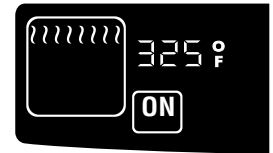

(example for Maxi Broil)

7. When broiling is done, turn off oven.

PRESS



(single ovens)

OR



(double ovens)

YOU SEE

(display will go blank)

Variable temperature broiling

- **If food is cooking too fast** or you want the food to broil slower from the start, set the broil temperature between 170°F and 325°F. These temperature settings allow the broil heating elements to cycle more frequently and to slow cooking. The lower the temperature, the slower the cooking.
- **Fish and chicken** are some foods that may cook better if you use lower broiling temperatures.



Convection broiling

(upper oven/single oven/both ovens on Models KEBS208D and KEBS278D)

Use this setting when broiling thick cuts of meat.

NOTE: These examples are for double upper ovens only. Other ovens may look slightly different.

1. Position rack.

See "Broiling rack positions" on page 35 for recommended rack positions.

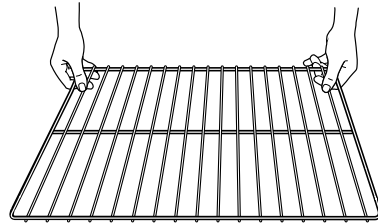
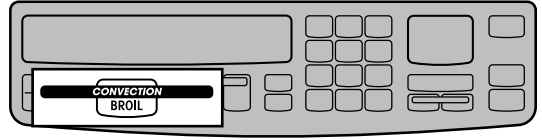

2. Close door.

NOTE: Do not try to convection broil with the door open. The fan and elements will not operate.

3. Choose Convection Broil setting.

NOTE: On double ovens, the cavity symbol flashes to tell you which oven you are setting.

PRESS



to select oven (for double ovens)

YOU SEE



(or 232°C)

PRESS



4. Set temperature (optional).

Do this step if you want to set a temperature (up to 500°F) other than 450°F.

NOTE: See your convection oven cookbook for temperature recommendations.

PRESS

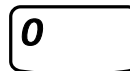
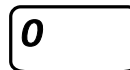

YOU SEE



(example shows 400°F temperature setting)

5. For best results, preheat oven for 5 minutes.

NOTE: If you want to change the convection broiling temperature after broiling has begun, repeat Steps 3, 4, and 5.

PRESS



YOU SEE

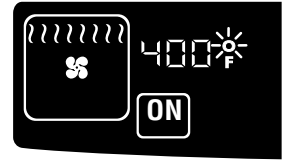

6. Put food in oven.

Place food on grid in broiler pan and place in center of the oven rack. Turn the pan so the long side is parallel to the oven door for the most even heat and the best airflow.

NOTE: If you want to change the convection broiling temperature after broiling has begun, repeat Steps 3, 4, and 5.

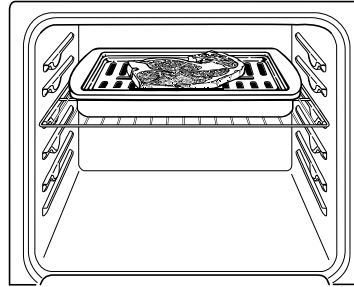

7. When broiling is over, turn off oven.

PRESS



(single ovens)

OR

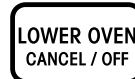
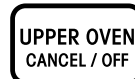

(double ovens)

YOU SEE

(display will go blank)

Broiling tips

- **Always start** broiling with a cold broiler pan for better results.
- **To retain more natural juice**, do not pierce meat with a fork.
- **Trim** the outer layer of fat from steaks and chops.
- **Slit** fatty edges to prevent meat from curling during broiling.
- **Use a nonstick cooking spray or vegetable oil** on the broiler pan and grid when broiling fish to prevent sticking.

NOTE: See “Broiling” on page 31 for additional broiling tips.

Broiling rack positions

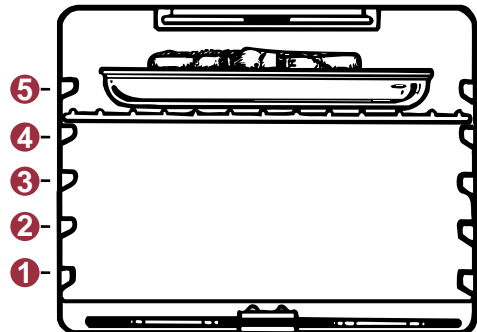



Timed cooking

The electronic clock/oven control will turn the oven on and off at times you set, even when you are not around.

Delayed time cooking is ideal for foods which do not require a preheated oven, such as meats and casseroles. **Do not use delayed time cooking for cakes, cookies, etc. – they will not rise properly. Before using timed cooking, make sure the clock is set to the correct time of day.** (See “Setting the clock” on page 14.)

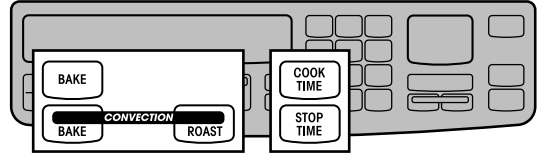

NOTE: These examples are for double upper ovens only. Other ovens may look slightly different.

⚠ WARNING

Food Poisoning Hazard

Do not let food sit in oven more than one hour before or after cooking.

Doing so can result in death, food poisoning, or sickness.

To start now and stop automatically:

1. Prepare oven.

Position the oven rack(s) properly and place the food in the oven. For correct rack placement, see “Baking or convection baking” on page 16 and “Rack placement” chart on page 20.

2. Choose setting.

- BAKE,
- CONVECTION BAKE, or
- CONVECTION ROAST

NOTE: On double ovens, the cavity symbol flashes to tell you which oven you are setting.

PRESS



to select oven (for double ovens)

YOU SEE

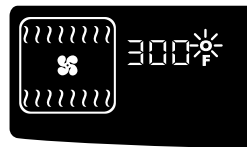

(example for Convection Roast)

PRESS



3. Set temperature (optional).

Do this step if you want to set a temperature other than the one displayed.

NOTE: See a reliable cookbook or your convection oven cookbook for temperature recommendations.

PRESS



YOU SEE

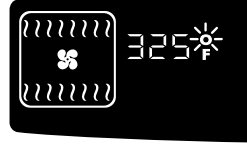

(example shows 325°F temperature setting in Convection Roast)

4. Press Cook Time pad.

PRESS



YOU SEE



(start time display will light up, showing time of day)

5. Set cook time.

PRESS

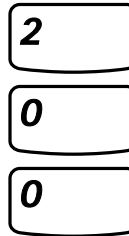

YOU SEE



(example shows 2-hour cook time with stop time now 2 hours later than time of day)

6. Start oven.

Vertical bar on display will get shorter as cook time counts down.

PRESS



YOU SEE



(cook time is displayed)

7. When baking/roasting is done:

“End” will show on the display. Four tones will sound, followed by 4 reminder tones (unless they have been disabled), every minute until you open the door, or press the Cancel/Off pad.

YOU SEE



(double oven display)



To delay start and stop automatically:

1. Prepare oven.

Position the oven rack(s) properly and place the food in the oven. For correct rack placement, see “Baking or convection baking” on page 16 and “Rack placement” chart on page 20.

2. Choose setting.

- BAKE,
- CONVECTION BAKE, or
- CONVECTION ROAST

NOTE: On double ovens, the cavity symbol flashes to tell you which oven you are setting.

PRESS



to select oven (for double ovens)

YOU SEE

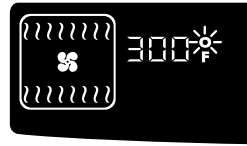

(example for Convection Roast)

PRESS



3. Set temperature (optional).

Do this step if you want to set a temperature other than the one displayed.

NOTE: See a reliable cookbook or your convection oven cookbook for temperature recommendations.

PRESS

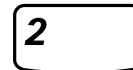

YOU SEE

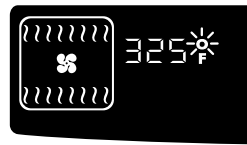

(example shows 325°F temperature setting in Convection Roast)

4. Press Cook Time pad.

PRESS



YOU SEE



(start time display will light up, showing time of day)

5. Set cook time.

PRESS

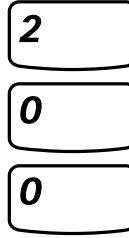

YOU SEE



(example shows 2-hour cook time with stop time now 2 hours later than time of day)

6. Press Stop Time pad.

PRESS



YOU SEE



7. Set stop time.

PRESS

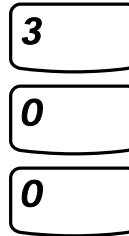

YOU SEE

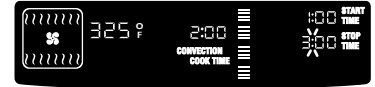

(stop time display shows 3:00 and start time display shows 1:00 – stop time minus 2-hour cook time)

8. Press Start pad.

PRESS



YOU SEE



When start time is reached:

Vertical bar on display will get shorter as cook time counts down.

YOU SEE



continued on next page



9. When baking/roasting is done:

“End” will show on the display. Four tones will sound, followed by 4 reminder tones (unless they have been disabled), every minute until you open the door, or press the Cancel/Off pad.

YOU SEE



(double oven display)

To cancel timed cooking settings:

Press Cancel/Off pad.

PRESS



(single ovens)

OR



(double ovens)

YOU SEE

(display will go blank)

Dehydrating

(upper oven/single oven/both ovens on Models KEBS208D and KEBS278D)

You can use your THERMAL-CONVECTION* oven to dehydrate fruits and vegetables.

NOTE: These examples are for double upper ovens only. Other ovens may look slightly different.

NOTE: If you do not turn off oven after dehydrating, the oven will keep running until you press CANCEL/OFF.

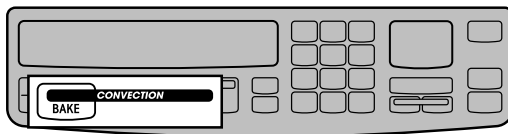

1. Prepare food.

Prepare foods as recommended in recipe.

2. Arrange food on drying racks.

Racks are not included with oven. Contact a local store handling specialty cooking utensils.

3. Close door.

NOTE: Do not try to dehydrate with the door open. The fan and elements will not operate.

4. Press and hold Convection Bake pad for 5 seconds.

NOTE: On double ovens, the cavity symbol flashes to tell you which oven you are setting.

PRESS



to select oven
(for double ovens)

YOU SEE



(or 60°C)

PRESS



Hold for
5 seconds

continued on next page



Using Your Oven

5. Set temperature (optional).

Do this step if you want to set a temperature (from 100°F to 200°F) other than 140°F.

PRESS



YOU SEE



(example shows 125°F dehydrating temperature)

6. Start oven.

NOTE: If you want to change the dehydrating temperature after dehydrating has begun, repeat Steps 4, 5, and 6.

PRESS



YOU SEE

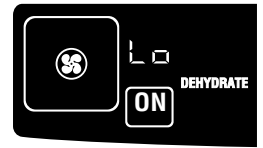

(display shows “Lo” until oven reaches 100°F)

7. When dehydrating is done, turn off oven.

PRESS



(single ovens)

OR



(double ovens)

YOU SEE

(display will go blank)

Raising (proofing) bread

(upper oven/single oven/both ovens on Models KEBS208D and KEBS278D)

You can use your THERMAL-CONVECTION* oven to proof bread. For more information see your convection oven cookbook, provided with your oven.

NOTE: These examples are for double upper ovens only. Other ovens may look slightly different.

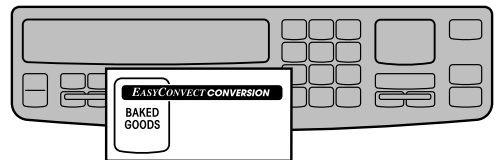

NOTE: If you do not turn off oven after proofing bread, the oven will keep running until you press Cancel/Off pad.

1. Put dough in oven.

NOTE: Be sure to close the door.

2. Press and hold Baked Goods pad for 5 seconds.

NOTE: On double ovens, the cavity symbol flashes to tell you which oven you are setting.

PRESS



to select oven (for double ovens)

YOU SEE



(or 38°C)

PRESS



Hold for 5 seconds

3. Start oven.

One long tone will sound when oven is preheated.

PRESS



YOU SEE



(display shows “Lo” until oven reaches 100°F)

4. When proofing is done, turn off oven.

PRESS



(single ovens)

OR



(double ovens)

YOU SEE

(display will go blank)

The oven vent(s)

Hot air and moisture escape from the oven(s) through vent(s). The vent for the oven is above the oven door. This vent is needed for air circulation. **Do not block the vent(s).** Poor baking/roasting can result.

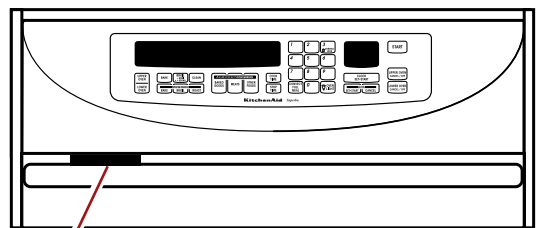

Oven vent

Caring for Your Oven

Cleaning your oven and controls

Make sure all controls are off and the oven is cool before cleaning. Your oven is designed for easy care. You can do most cleaning with items found around your home. Cleaning your oven whenever spills or soiling occurs will help to keep it looking and operating like new.

Do not use commercial oven cleaners in your oven.

PART	WHAT TO USE	HOW TO CLEAN
Control panel	Sponge and warm, soapy water OR Paper towel and spray glass cleaner	<ul style="list-style-type: none">• Wash, wipe with clean water, and dry thoroughly.• Do not use steel wool or abrasive cleansers. They may damage the finish.• Do not spray cleaner directly on panel. Apply cleaner to paper towel. <p>NOTE: Set the Control Lock to prevent the oven from accidentally turning on when you are cleaning the panel. (See “Using the control lock” on page 9.)</p>
Exterior surfaces (other than control panel)	Sponge and warm, soapy water	<ul style="list-style-type: none">• Wash, wipe with clean water, and dry thoroughly.• Use nonabrasive, plastic scrubbing pad on heavily soiled areas.• Do not use abrasive or harsh cleansers. They may damage the finish.
Broiler pan and grid (clean after each use)	Steel-wool pad and warm, soapy water	<ul style="list-style-type: none">• Wash, rinse, and dry thoroughly.• Do not clean the pan and grid in the Self-Cleaning cycle.
Oven racks	Steel-wool pad and warm, soapy water OR The Self-Cleaning cycle	<ul style="list-style-type: none">• Wash, rinse, and dry thoroughly. <p>OR</p> <ul style="list-style-type: none">• Leave in oven during Self-Cleaning cycle. <p>NOTE: Racks will permanently discolor and become harder to slide if left in oven during the Self-Cleaning cycle. Apply a small amount of vegetable oil to the side rungs to aid sliding.</p>
Oven door glass	Paper towel and spray glass cleaner OR Warm, soapy water and a nonabrasive, plastic scrubbing pad	<ul style="list-style-type: none">• Make sure oven is cool.• Follow directions provided with the cleaner.• Wash, wipe with clean water, and dry thoroughly.
Oven cavity	Self-Cleaning cycle	<ul style="list-style-type: none">• See “Using the Self-Cleaning Cycle” on pages 47-51.



Removing the oven door

For normal use of your oven, you do not need to remove the door. However, you can remove the door by following the instructions in this section.

The oven door is heavy. Use both hands to remove and replace the door. Do not lift and carry the door by the handle. To remove and replace the door you may need help.

To remove:

1. Open door all the way.

NOTE: Two $\frac{5}{32}$ " Allen wrenches or two nails of similar diameter may be used if factory furnished door removal pins have been misplaced. Be careful not to damage porcelain finish.

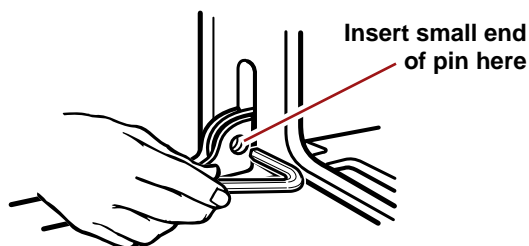

2. Insert small end of a door removal pin into each door hinge.

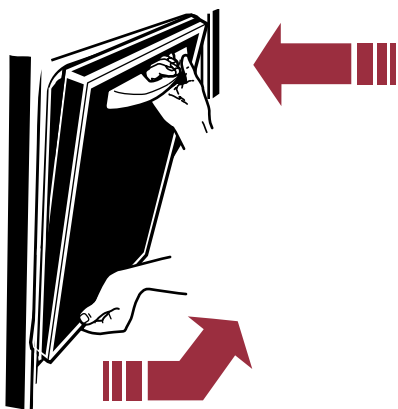

3. Grasp under handle and gently close door as far as it will shut. Pull door out at bottom to remove.
4. Set door aside on protected surface.

To replace:





1. Fit hinge arms into slots in frame. Push in at lower corners to insure that hinge arms are fully engaged.
2. Open the door all the way.
3. Remove the door removal pins from each hole.
4. Close the door.

NOTE: If the door does not operate freely, you have not installed it properly. Repeat Steps 1-4.



Using and replacing the oven lights

The oven lights will come on when you open the oven door. To turn the lights on when the oven door is closed, **press** the Oven Light pad  on the control panel. **Press** the pad  again to turn off the lights.

Replacing the oven light:

1. **Disconnect** appliance at the main power supply. Make sure the oven is cool before replacing the light bulb.

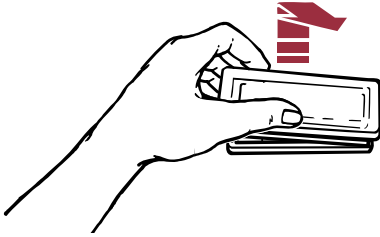

2. **Remove** glass light cover by grasping the front edge of the cover and pulling it away from the side wall of the oven.
3. **Remove** the light bulb from its socket. **Replace** the bulb with another halogen bulb (12 volt, 5 watt maximum, available at most hardware stores).
4. **Replace** the light cover by snapping it back into wall. The light cover must be in place when using the oven. The cover protects the bulb from breaking and from high oven temperatures.
5. **Reconnect** appliance at the main power supply.

NOTE: On both single and double ovens, the oven lights will not work during the Self-Cleaning cycle.

Using the Self-Cleaning Cycle

The Self-Cleaning cycle saves you from the toil and mess that often come with hand-cleaning the oven interior. Like the other functions of your oven, you operate the Self-Cleaning cycle with the easy-to-use electronic control. To use this cycle properly, follow the step-by-step instructions in this section.

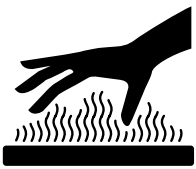
	! WARNING
	<p>Burn Hazard</p> <p>Do not touch the oven during the Self-Cleaning cycle. Keep children away from oven during Self-Cleaning cycle. Do not use commercial oven cleaners in your oven. Failure to follow the above can result in burns, or illness from inhaling dangerous fumes.</p>

Before you start

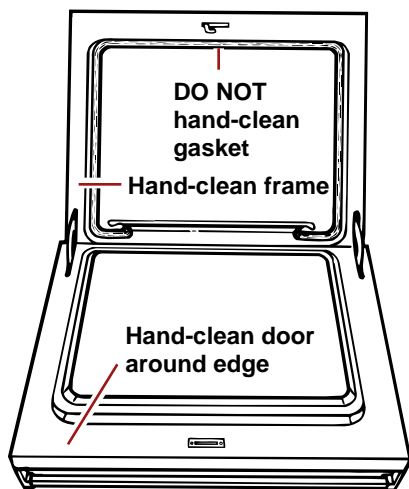

Before you start the Self-Cleaning cycle, make sure you:

- **Hand-clean the areas shown.** They do not get hot enough during the Self-Cleaning cycle for soil to burn away. Use hot water and detergent or a soapy, steel-wool pad for cleaning.

NOTES:

- **DO NOT** clean, move, or bend the gasket. Poor cleaning, baking, and roasting may result.
- **DO NOT** let water, cleaner, etc., enter slots on door and frame.

- **Remove** the broiler pan and grid and anything else being stored in the oven.
- **Wipe out** any loose soil or grease. This will help reduce smoke during the Self-Cleaning cycle.
- **Remove** the oven racks from the oven if you want them to remain shiny. You can clean the oven racks in the Self-Cleaning cycle, but they will become harder to slide. (See page 44.) If you clean racks in the Self-Cleaning cycle, place them on the 2nd and 4th rack guides. (Guides are counted from bottom to top.)
- **Heat and odors** are normal during the Self-Cleaning cycle. Keep the kitchen well ventilated by opening a window or by turning on a vent hood or other kitchen vent during the cycle.

NOTES:

- **Do not block** the oven vent during the Self-Cleaning cycle. Air must move freely for best cleaning results.
- **Do not leave** any foil in oven during the Self-Cleaning cycle. Foil could burn or melt and damage the oven surface.
- **The oven light** will not work during the Self-Cleaning cycle.



Using the Self-Cleaning Cycle

Before setting the controls

- Make sure clock is set to correct time of day. The clock cannot be set during the Self-Cleaning cycle.
- Make sure the oven door is completely closed.

Setting the controls

NOTE: These examples are for double upper ovens only. Other ovens may look slightly different.

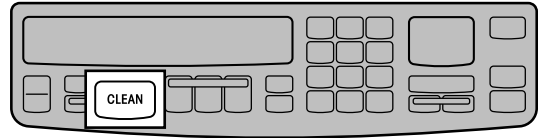

To start cleaning immediately:

1. Press Clean pad.

A 3½-hour Self-Cleaning cycle will be set. (The first 3 hours are for cleaning, the last 30 minutes are for cooling.)

NOTE: On double ovens, the cavity symbol flashes to tell you which oven you are setting. The electronic control will not let both ovens be active while one oven is cleaning.

PRESS



to select oven (for double ovens)

YOU SEE



(stop time display shows time 3½ hours later than time of day – shown in start time display)

PRESS



2. Set cleaning time (optional).

If you want a Self-Cleaning cycle other than 3½ hours, **press** the desired Number pads for the new time from 2½ to 4½ hours.

- Use 2½ hours for light soil.
- Use 3½-4½ hours for moderate to heavy soil.

PRESS

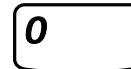
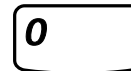

YOU SEE



(example shows 4-hour cleaning cycle with stop time now 4 hours later than time of day)



3. Start oven.

NOTE: The door will lock right after you press START.

PRESS



YOU SEE



4. After the Self-Cleaning cycle ends:

YOU SEE



(double oven display)

To delay cleaning start time:

1. Press Clean pad.

A 3½-hour Self-Cleaning cycle will be set. (The first 3 hours are for cleaning, the last 30 minutes are for cooling.)

NOTE: On double ovens, the cavity symbol flashes to tell you which oven you are setting. The electronic control will not let both ovens be active while one oven is cleaning.

PRESS



to select oven (for double ovens)

YOU SEE



(stop time display shows time 3½ hours later than time of day – shown in start time display)

PRESS



2. Set cleaning time (optional).

If you want a Self-Cleaning cycle other than 3½ hours, **press** the desired Number pads for the new time from 2½ to 4½ hours.

- Use 2½ hours for light soil.
- Use 3½-4½ hours for moderate to heavy soil.

PRESS

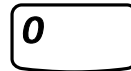
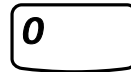

YOU SEE



(example shows 4-hour cleaning cycle with stop time now 4 hours later than time of day)

3. Press Stop Time pad.

PRESS



YOU SEE



continued on next page



Using the Self-Cleaning Cycle

4. Set stop time.

Example for 7:00:

PRESS

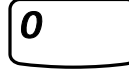
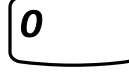

YOU SEE



(display shows stop time of 7:00 and start time of 3:00 – stop time minus cleaning time)

5. Complete entry.

NOTES:

- **The door** will lock right after you press START.
- **Lights** will stay on until start time is reached.

When the start time is reached:

PRESS



YOU SEE



YOU SEE



6. After the Self-Cleaning cycle ends:

YOU SEE



(double oven display)

To stop the Self-Cleaning cycle at any time:

PRESS



(single ovens)

OR



(double ovens)

YOU SEE



(double oven display) (“cln”, “cooling”, and “DOOR LOCKED” will appear if oven has not cooled down and you try to program another cooking function)



For best cleaning results

- **After the oven is cool**, wipe up any residue or ash with a damp cloth or sponge. If any spots remain, clean with a mild abrasive cleanser or cleaning sponge.
- **Clean the oven** before it gets heavily soiled. Cleaning a very soiled oven takes longer and results in more smoke than usual.
- **If the Self-Cleaning cycle does not get the oven as clean as you expected**, the cycle may not have been set long enough or you may not have prepared the oven properly. Set the Self-Cleaning cycle longer the next time and hand-clean areas noted on page 47.

How the cycle works

The Self-Cleaning cycle uses very high heat to burn away soil and grease. During the cycle, the oven gets much hotter than it does for normal baking or broiling. This high heat breaks up the soil or grease and burns it away.

Your oven is preset for a 3½-hour Self-Cleaning cycle. However, you can adjust the cycle time to the amount of soil in your oven. You can set the cycle anywhere between 2½ and 4½ hours. (See “Setting the controls” on page 48.)

The graph at the right is representative of a normal, 3½-hour Self-Cleaning cycle. Note that the heating stops after 3 hours, but it takes longer for the oven to cool enough to unlock.

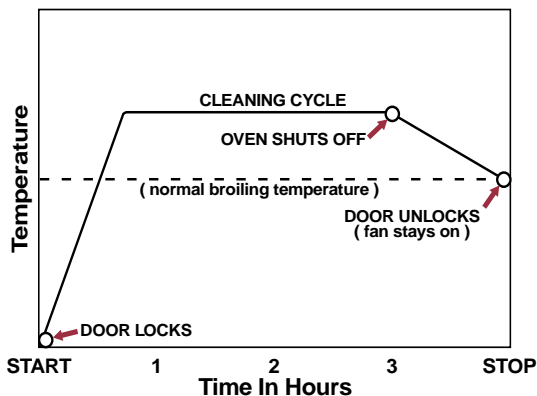

Troubleshooting

Most cooking problems often are caused by little things you can find and fix without tools of any kind. Check the lists below and on the next page before calling for assistance or service. If you still need help, see “Requesting Assistance or Service” on pages 54 and 55.

If nothing operates, check the following:

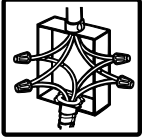

Is the oven wired into a live circuit with the proper voltage?
(See Installation Instructions.)



Have you blown a household fuse or tripped a circuit breaker?

Other possible problems and their causes:

PROBLEM	CAUSE
The oven will not operate	<ul style="list-style-type: none">• You have not set the electronic control correctly. Refer to the section in this manual describing the function you are operating.• You have programmed a delayed start time. Wait for the start time to be reached or cancel and reset the controls.
The Self-Cleaning cycle will not operate	<ul style="list-style-type: none">• You have programmed a delayed start time. Wait for the start time to be reached or cancel and reset the controls.• You have programmed another function in the other oven on a double oven. Cancel and reprogram oven.
Display is blank	<ul style="list-style-type: none">• You have set the display not to show the clock time. To see the clock time again, press and hold the Clock Set/Start pad for 5 seconds.



PROBLEM	CAUSE
<p>Cooking results are not what you expected</p>	<ul style="list-style-type: none"> • The oven is not level. (See Installation Instructions.) • The oven temperature seems too low or too high. See “Adjusting oven temperature” on page 22 to adjust oven temperature. • You did not preheat the oven before baking (if called for in recipe). • The recipe you are using may need to be altered to improve the taste or appearance of the food. • You are using a pan that is not the correct type or size. Refer to a reliable cookbook or recipe for recommended pan type and size. • There is not enough air space around pan when baking. Allow 1½ to 2 inches (4-5 cm) of air space on all sides of pan. There must be a minimum space of 1 inch.
<p>The display is showing “PF”</p>	<ul style="list-style-type: none"> • There has been a power failure. Reset the clock. (See page 14.)
<p>A letter followed by a number shows on the display (for example “E3”, “F1”)</p>	<ul style="list-style-type: none"> • Press Cancel/Off pad. If the code reappears, note the code and call for service. (See Step 2 on pages 54 and 55.)
<p>The key pads do not operate</p>	<ul style="list-style-type: none"> • The Control Lock has been set. (See “Using the control lock” on page 9.) Turn off the Control Lock by pressing and holding the Control Lock pad (Number Pad 3) for 5 seconds. • The Sabbath mode has been set (“Sab” appears on the display). Turn off the Sabbath mode by pressing and holding Number Pad 6 for 5 seconds.

If none of these items was causing your problem, see “Requesting Assistance or Service” on pages 54 and 55.

Requesting Assistance or Service in the U.S.A.

1. If the problem is not due to one of the items listed in "Troubleshooting" on pages 52-53†:

- Call KitchenAid Consumer Assistance Center:



1-800-422-1230

One of our trained consultants can instruct you in how to

obtain satisfactory operation from your appliance or, if service is necessary, recommend a qualified service company in your area.

- If you prefer, write to:
KitchenAid Brand Home Appliances
Consumer Assistance Center
% Correspondence Dept.
2000 North M-63
Benton Harbor, MI 49022-2692

Please include a daytime phone number in your correspondence.

2. If you need service†:

- Call your dealer or the repair service he recommends.



- All service should be handled locally by the dealer from whom you purchased the unit or an authorized KitchenAid servicer.

- If you are unable to obtain the name of a local authorized KitchenAid servicer, call our Consumer Assistance Center telephone number (see Step 1).

3. If you are not satisfied with the action taken:

- Contact the Major Appliance Consumer Action Program (MACAP). MACAP is a group of independent consumer experts that voices consumer views at the highest levels of the major appliance industry.
- Contact MACAP only when the dealer, authorized servicer, and KitchenAid have failed to resolve your problem.

Major Appliance Consumer Action Program
20 North Wacker Drive
Chicago, IL 60606

- MACAP will in turn inform us of your action.

† When asking for help or service:

Please provide a detailed description of the problem (including any information that appears on the electronic control display), your appliance's complete model and serial numbers, and the purchase date. (See page 3.) This information will help us respond properly to your request.

Don't forget, KitchenAid offers a full line of quality home appliances.

Built-In Refrigerators	Trash Compactors	Ranges & Cooktops
Freestanding Refrigerators	Hot Water Dispensers	Microwave Ovens
50-Pound Ice Makers	Food Waste Disposers	Washers & Dryers
Dishwashers	Built-In Ovens	Mixers & Blenders

For more information on these appliances, or the one you have purchased, call our toll-free Consumer Assistance Center telephone number, **1-800-422-1230** (in U.S.A.) or contact your authorized Inglis Limited** Appliance Service company (in Canada).

Requesting Assistance or Service in Canada

Before calling for assistance or service, please check “Troubleshooting” on pages 52 and 53. If you still need help, follow the instructions below. When calling, please know the purchase date and the complete model and serial number of your appliance (see page 3). This information will help us to better respond to your request.

1. For Assistance:

Call the Consumer Assistance Centre



1-800-461-5681

- Use and maintenance procedures
- Referrals to local dealers
- Specifications on all our appliances

2. For Service:

Call the Consumer Service Centre



1-800-807-6777

- Maintenance and repair service
- Accessory and repair part sales

Authorized Service Centres

For service of Inglis, Whirlpool, KitchenAid, Roper, Estate, & Admiral Appliances

Direct Service Branches:

BRITISH COLUMBIA	Vancouver	Inglis Home Appliance Service 3627 E. 4th Avenue	604-291-6426 1-800-665-6788
	Victoria	Inglis Home Appliance Service	1-800-665-6788
ALBERTA	Edmonton	Inglis Home Appliance Service 11653 163rd Street	403-453-3900 1-800-661-6291
	Calgary	Inglis Home Appliance Service	403-253-9267
ONTARIO	Toronto (Mississauga)	Inglis Home Appliance Service 5945 Ambler Drive	905-821-3900 1-800-807-6777
	Toronto (Markham)	Inglis Home Appliance Service 110 Torbay Road, Unit 1	905-475-9511 1-800-807-6777
	Ottawa	Inglis Home Appliance Service 28 Capital Drive	613-225-0510 1-800-267-3456
MANITOBA	Winnipeg	Inglis Home Appliance Service 1683 Church Avenue	204-694-5308 1-800-665-1683
QUEBEC	Montreal (Laval)	Inglis Home Appliance Service 2750 Francis-Hughes	514-382-8110 1-800-361-3032
	Brossard	Inglis Home Appliance Service 9605 Ignace Street, Unit F	514-397-1840 1-800-361-0950
	Quebec City	Inglis Home Appliance Service 5275 Wilfrid-Hamel Blvd., Suite 140	418-871-5251 1-800-463-1523
	Sherbrooke (Rock Forest)	Inglis Home Appliance Service 3475 Industriel Blvd.	819-564-6565 1-800-567-6966
NOVA SCOTIA	Dartmouth	Inglis Home Appliance Service 900 Windmill Road, Unit 109	902-468-6634 1-800-565-1598
SASKATCHEWAN	Regina	Inglis Home Appliance Service	1-800-665-1683
	Saskatoon	Inglis Home Appliance Service	1-800-665-1683

For service in areas other than those listed, contact the Consumer Service Centre, your local appliance dealer, or consult your telephone directory yellow pages.

Index

This index is alphabetical. It contains all the topics included in this manual, along with the page(s) on which you can find each topic.

TOPIC	PAGE	TOPIC	PAGE
ASSISTANCE	54, 55	CONVECT FULL MEAL	26
BAKING		CONVECTION BAKING	
Aluminum foil	20	Pans	20
Pans	20	Setting	17
Setting cycle	17	Tips	21
Tips	20	CONVECTION BROILING	34
BROILING		DEHYDRATING	41
Grid	32	EASY CONVECT* Conversion	29
Pan	32	FEATURES	6
Setting cycle	32	LIGHT	46
Tips	35	LOCK	
CLEANING		Control	9
Broiler pan and grid	44	Self-cleaning cycle	49, 50
Control panel	44	MODEL AND SERIAL NUMBER	3
Exterior surfaces	44	OVEN DOOR	45
Oven cavity	44	OVEN TEMPERATURE	
Oven door glass	44	Adjusting	22
Oven racks	44	Setting... 17, 19, 24, 29, 33, 34, 37, 38, 42	
Removing oven door	45	OVEN VENT(S)	43
Self-cleaning cycle	47	PARTS	6
CONTROL PANEL		RACKS	
Canceling	8	Convection roasting rack	21
Celsius cooking	7	Placement	20
Celsius/Fahrenheit conversion	7	Positions	16
Changing audible signals	8	RAISING BREAD	42
Clock	14	ROASTING	
Command pads	7	Rack	21
Control lock	9	Setting cycle	19
Disabling clock display	14	Tips	21
Display	7	SAFETY	4-5
Finding out oven in use	8		
Number pads	7		
Sabbath feature (double oven)	10		
Sabbath feature (single oven)	9		
Selecting an oven	8		
Settings	12-13		
Signals	8		
Starting	8		
Start?	8		
Timer	15		
Tones	8		

TOPIC	PAGE
SELF-CLEANING	
Delay cleaning	49
How cycle works	51
Preparing oven	47
Setting controls	48-50
Starting immediately	48
Stopping cycle	50
Tips	51
SERVICE	54, 55
TEMPERATURE PROBE	
Cleaning	26
Connecting to oven	24
Inserting in food	23
Setting cycle	24
TIMED COOKING	
Canceling	40
Cook time	37, 38
Stop time	39
TROUBLESHOOTING	52
WARRANTY	60

KitchenAid*

Electric Built-In Oven

Warranty

LENGTH OF WARRANTY:	KITCHENAID WILL PAY FOR:	KITCHENAID WILL NOT PAY FOR:
ONE-YEAR FULL WARRANTY FROM DATE OF PURCHASE	Replacement parts and repair labor costs to correct defects in materials or workmanship. Service must be provided by an authorized KitchenAid servicing outlet.	A. Service calls to: <ol style="list-style-type: none"> 1. Correct the installation of the oven. 2. Instruct you how to use the oven. 3. Replace house fuses or correct house wiring. B. Repairs when oven is used in other than normal home use. C. Damage resulting from accident, alteration, misuse, abuse, improper installation, or installation not in accordance with local electrical codes. D. Any labor costs during the limited warranties. E. Replacement parts or repair labor costs for units operated outside the United States and Canada. F. Pickup and delivery. This product is designed to be repaired in the home. G. Repairs to parts or systems caused by unauthorized modifications made to the appliance.
SECOND-THROUGH FIFTH-YEAR LIMITED WARRANTY FROM DATE OF PURCHASE	Replacement parts for any electric element to correct defects in materials or workmanship. Replacement parts for solid state touch control system to correct defects in materials or workmanship.	
SECOND-THROUGH TENTH-YEAR LIMITED WARRANTY FROM DATE OF PURCHASE	Replacement parts for the porcelain oven cavity/inner door if the part rusts through due to defects in materials or workmanship.	

3/96

KITCHENAID DOES NOT ASSUME ANY RESPONSIBILITY FOR INCIDENTAL OR CONSEQUENTIAL DAMAGES. Some states or provinces do not allow the exclusion or limitation of incidental or consequential damages, so this exclusion or limitation may not apply to you. This warranty gives you specific legal rights and you may also have other rights which may vary from state to state or province to province.

Outside the United States and Canada, a different warranty may apply. For details, please contact your authorized KitchenAid dealer.

If you need service, first see the "Troubleshooting" section of this book. After checking "Troubleshooting," additional help can be found by checking the "Requesting Assistance or Service" sections or by calling our Consumer Assistance Center telephone number, **1-800-422-1230**, from anywhere in the U.S.A. In Canada, call KitchenAid Canada at one of the telephone numbers listed on page 3.

KitchenAid
Benton Harbor, Michigan, U.S.A. 49022-2692