

UNDERCOUNTER DISHWASHER

Use & Care Guide

For questions about features, operation/performance,
parts, accessories or service, call: 1-800-253-1301.

or visit our website at...
www.estateappliances.com

Table of Contents	2
-------------------------	---



Model TUD6700P

TABLE OF CONTENTS

DISHWASHER SAFETY	3
Before Using Your Dishwasher	4
PARTS AND FEATURES	5
START-UP GUIDE	6
Using Your New Dishwasher	6
Stopping Your Dishwasher	6
DISHWASHER LOADING	6
Loading Suggestions	6
Loading Top Rack.....	7
Loading Bottom Rack	7
Loading Silverware Basket	8
DISHWASHER USE	8
Detergent Dispenser	8
Rinse Aid Dispenser	9
Dishwasher Efficiency Tips	9
Cycle Selection Charts.....	10
Canceling a Cycle	11
Changing a Cycle or Setting	11
Adding Items During a Cycle	11
Option Selections.....	11
Using the Plate Warmer	11
Drying System	11
Overfill Protection Float.....	11
WASHING SPECIAL ITEMS	12
DISHWASHER CARE	13
Cleaning.....	13
Drain Air Gap	13
Storing	13
TROUBLESHOOTING	14
ASSISTANCE OR SERVICE	15
WARRANTY	16

DISHWASHER SAFETY

Your safety and the safety of others are very important.

We have provided many important safety messages in this manual and on your appliance. Always read and obey all safety messages.



This is the safety alert symbol.

This symbol alerts you to potential hazards that can kill or hurt you and others.

All safety messages will follow the safety alert symbol and either the word “DANGER” or “WARNING.” These words mean:

⚠ DANGER

You can be killed or seriously injured if you don't immediately follow instructions.

⚠ WARNING

You can be killed or seriously injured if you don't follow instructions.

All safety messages will tell you what the potential hazard is, tell you how to reduce the chance of injury, and tell you what can happen if the instructions are not followed.

IMPORTANT SAFETY INSTRUCTIONS

WARNING: When using the dishwasher, follow basic precautions, including the following:

- Read all instructions before using the dishwasher.
- Use the dishwasher only for its intended function.
- Use only detergents or rinse agents recommended for use in a dishwasher, and keep them out of the reach of children.
- When loading items to be washed:
 - 1) Locate sharp items so that they are not likely to damage the door seal; and
 - 2) Load sharp knives with the handles up to reduce the risk of cut-type injuries.
- Do not wash plastic items unless they are marked “dishwasher safe” or the equivalent. For plastic items not so marked, check the manufacturer's recommendations.
- Do not touch the heating element during or immediately after use.
- Do not operate the dishwasher unless all enclosure panels are properly in place.
- Do not tamper with controls.
- Do not abuse, sit on, or stand on the door, lid, or dish racks of the dishwasher.
- To reduce the risk of injury, do not allow children to play in or on the dishwasher.
- Under certain conditions, hydrogen gas may be produced in a hot water system that has not been used for two weeks or more. **HYDROGEN GAS IS EXPLOSIVE.** If the hot water system has not been used for such a period, before using the dishwasher turn on all hot water faucets and let the water flow from each for several minutes. This will release any accumulated hydrogen gas. As the gas is flammable, do not smoke or use an open flame during this time.
- Remove the door or lid to the washing compartment when removing an old dishwasher from service or discarding it.

SAVE THESE INSTRUCTIONS

Before Using Your Dishwasher

⚠ WARNING

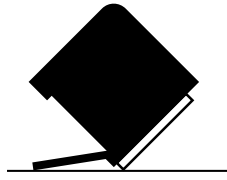

Tip Over Hazard

Do not use dishwasher until completely installed.

Do not push down on open door.

Doing so can result in serious injury or cuts.

⚠ WARNING



Electrical Shock Hazard

Electrically ground dishwasher.

Connect ground wire to green ground connector in terminal box.

Do not use an extension cord.

Failure to follow these instructions can result in death, fire, or electrical shock.

GROUNDING INSTRUCTIONS

■ **For a grounded, cord-connected dishwasher:**

The dishwasher must be grounded. In the event of a malfunction or breakdown, grounding will reduce the risk of electric shock by providing a path of least resistance for electric current. The dishwasher is equipped with a cord having an equipment-grounding conductor and a grounding plug. The plug must be plugged into an appropriate outlet that is installed and grounded in accordance with all local codes and ordinances.

WARNING: Improper connection of the equipment-grounding conductor can result in a risk of electric shock. Check with a qualified electrician or service representative if you are in doubt whether the dishwasher is properly grounded. Do not modify the plug provided with the dishwasher; if it will not fit the outlet, have a proper outlet installed by a qualified electrician.

■ **For a permanently connected dishwasher:**

The dishwasher must be connected to a grounded metal, permanent wiring system, or an equipment-grounding conductor must be run with the circuit conductors and connected to the equipment-grounding terminal or lead on the dishwasher.

SAVE THESE INSTRUCTIONS

- Install where dishwasher is protected from the elements. Protect against freezing to avoid possible rupture of fill valve. Such ruptures are not covered by the warranty. See "Storing" in the "Dishwasher Care" section for winter storage information.
- Install and level dishwasher on a floor that will hold the weight, and in an area suitable for its size and use.
- Remove all shipping plugs from hoses and connectors (such as the cap on the drain outlet) before installing. See Installation Instructions for complete information.

PARTS AND FEATURES

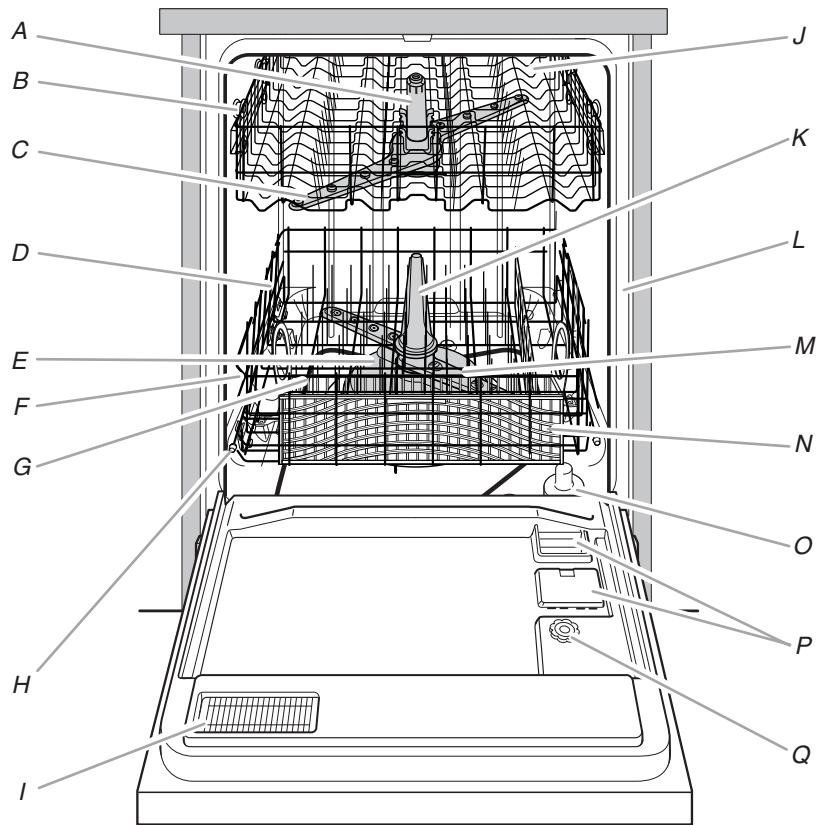

- A. Third level wash
- B. 3 position rack adjusters
- C. Top spray arm
- D. Bottom rack
- E. Filter module
- F. Water inlet opening (in tub wall)

- G. Heating element
- H. Rack bumper
- I. Vent
- J. Top rack
- K. Spray tower

- L. Model and serial number label
- M. Lower spray arm
- N. Silverware basket
- O. Overfill protection float
- P. Detergent dispenser
- Q. Rinse aid dispenser

Control Panel

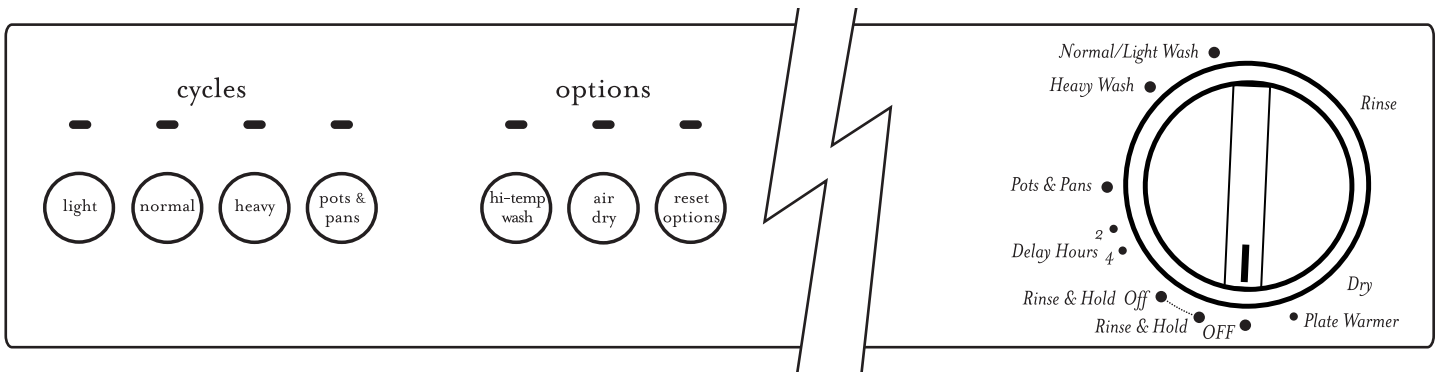

START-UP GUIDE

Before using your dishwasher, remove all packaging materials. Read this entire Use and Care Guide. You will find important safety information and useful operating tips.

Using Your New Dishwasher

1. Scrape large food soil and hard items (toothpicks or bones) from dishes.
2. Properly load the dishwasher. (See “Dishwasher Loading.”) Make sure nothing prevents the spray arm(s) from spinning freely.

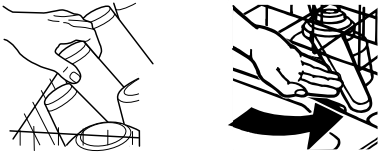

3. Add detergent and check the rinse aid dispenser. Add rinse aid if needed. (See “Dishwasher Use.”)

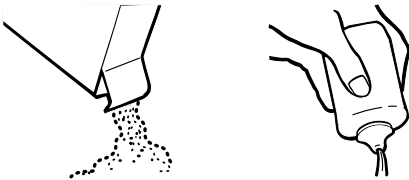

4. Push door firmly closed. The door latches automatically. Run hot water at the sink nearest your dishwasher until the water is hot. (See “Dishwasher Efficiency Tips.”) Turn off water.

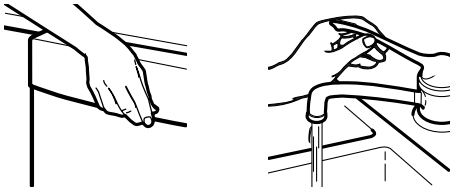

5. Select the desired cycle. (See “Dishwasher Use.”)

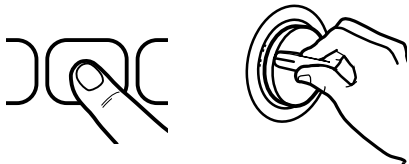

6. Select the desired option. (See “Option Selections.”)

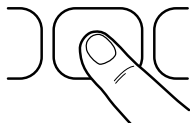

Stopping Your Dishwasher

You can stop your dishwasher anytime during a cycle.

1. Open the door slightly.
2. Wait for the spraying action to stop. Then open the door all the way, if needed.
3. Close the door to continue the cycle.

OR

1. Turn the cycle control knob slowly clockwise until you hear water draining. Let the dishwasher drain completely.
 2. Open the door.
 3. Turn the cycle control knob to Off.
-

DISHWASHER LOADING

Loading Suggestions

- Remove leftover food, bones, toothpicks and other hard items from the dishes. It is not necessary to rinse the dishes before putting them into the dishwasher. The wash module removes food particles from the water. The module contains a chopping device which will reduce the size of food items.

NOTE: If hard items such as fruit seeds, nuts, and eggshells enter the wash module, you might hear chopping, grinding, crunching, or buzzing sounds. These sounds are normal when hard items enter the module. Do not let metallic items (such as pot handle screws) get into the wash module. Damage can occur.

- It is important for the water spray to reach all soiled surfaces.
 - Load dishes so they are not stacked or overlapping, if possible. For best drying, water must be able to drain from all surfaces.
 - Make sure pot lids and handles, pizza pans, cookie sheets, etc., do not interfere with the spray arm rotation.
 - Run a rinse cycle to keep dishes moist if you do not plan to wash them soon. Foods such as eggs, rice, pasta, spinach, and cooked cereals may be hard to remove if they are left to dry over a period of time.
-

Quiet operating tips

To avoid thumping/clattering noises during operation:

- Make sure lightweight load items are secured in the racks.
- Make sure pot lids and handles, pizza pans, cookie sheets, etc., do not touch interior walls or interfere with the rotation of the spray arm.
- Load dishes so they do not touch one another.

NOTE: For built-in models, keep sink drain plugs closed during dishwasher operation to prevent noise transfer through drains.

Loading Top Rack

The top rack is designed for cups, glasses, and smaller items. (See recommended loading patterns shown.)

NOTE: The features on your dishwasher rack may vary from the drawings shown.

Do not cover third level spray. See arrow.

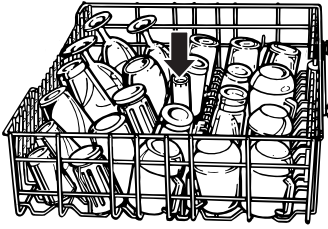

Cup and glass load

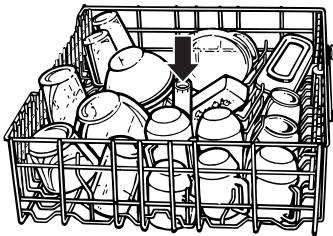

Mixed load

- Place items so open ends face down for cleaning and draining.
- Load glasses and cups in top rack only. The bottom rack is not designed for glasses and cups. Damage can occur.
- Place cups and glasses in the rows between prongs. Placing them over the prongs can lead to breakage.
- To avoid chipping, do not let stemware touch other items.
- China, crystal, and other delicate items must not touch each other during dishwasher operation. Damage can occur.
- Wedge lightweight items against one another or overlap them with heavier dishes.
- Load plastic items securely in the top rack only. Wash only plastic items marked "dishwasher safe."
- Small bowls, pans, and other utensils can be placed in the top rack.
- Load bowls in the center section for best stability.

Adjustable 3-position top rack

You can raise or lower the top rack to fit tall items in either the top or bottom rack. Two adjusters are located on each side of the top rack. Each adjuster has 3 preset positions. The high and low positions are marked on the adjuster.

To adjust the top rack

1. Hold the top rack with one hand near the adjuster.

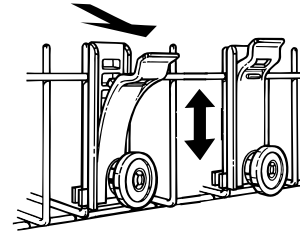

2. With the other hand, pull out the top of the adjuster.
3. Raise or lower the rack to one of the preset positions.
4. Release the adjuster.

Repeat the steps for the remaining adjusters as needed. The 4 adjusters can be raised or lowered separately or together. The top rack does not have to be level.

Loading Bottom Rack

The bottom rack is designed for plates, pans, casseroles, and utensils. Items with cooked-on or dried-on food should be loaded with soiled surfaces facing inward to the spray. (See recommended loading patterns shown.)

NOTE: The features on your dishwasher rack may vary from the drawings shown.

Do not cover spray tower. See arrow.

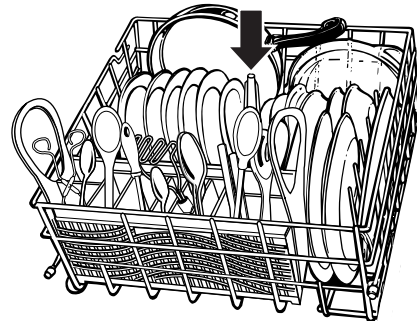

Mixed load

- Do not load glasses, cups, or plastic items in the bottom rack. Load small items in the bottom rack only if they are secured in place.
- Load plates, soup bowls, etc., between tines and facing inward to the spray.
- Overlap the edges of plates for large loads.
- Load soup, cereal, and serving bowls in the rack in a variety of ways depending upon their size and shape. Load bowls securely between the rows of tines. Do not nest bowls because the spray will not reach all surfaces.

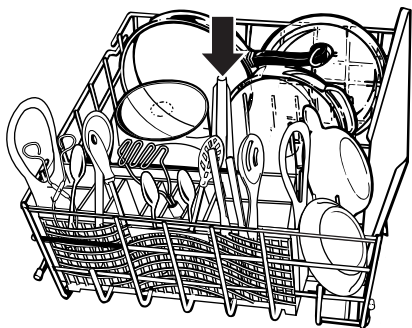

Utensil load

- Load cookie sheets, cake pans, and other large items at the sides and back. Loading such items in front can keep the water spray from reaching the detergent dispenser and silverware basket.
- Secure heavily soiled cookware face down in the rack.
- Make sure pot handles and other items do not stop rotation of the spray arm(s). The spray arm(s) must move freely.
- Do not load items between the bottom rack and the side of the dishwasher tub. You can block the water inlet opening.

NOTE: If you have removed the bottom rack for unloading or cleaning, replace it with the bumpers in front.

Loading Silverware Basket

Load the silverware basket while it is in the bottom rack or take the basket out for loading on a counter or table.

NOTE: Unload or remove the basket before unloading the racks to avoid spilling water droplets onto the silverware.

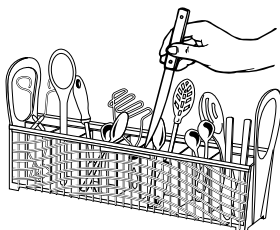

Mix items in each section of the basket with some pointing up and some down to avoid nesting. Spray cannot reach nested items.

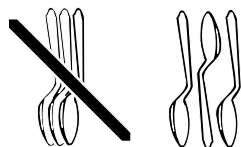

IMPORTANT: Always load items (knives, skewers, etc.) pointing down.

NOTES:

- Do not load silver or silver-plated silverware with stainless steel. These metals can be damaged by contact with each other during washing.
- Some foods (such as salt, vinegar, milk products, fruit juices, etc.) can pit or corrode silverware. Run a rinse cycle if you do not have a full load to wash immediately.

DISHWASHER USE

Detergent Dispenser

The detergent dispenser has 2 sections. The Pre-Wash section empties detergent into the dishwasher when you close the door.

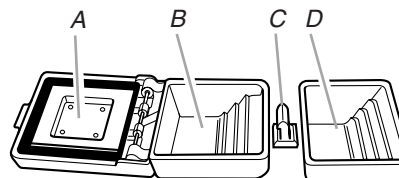

- A. Cover
- B. Main Wash section
- C. Cover latch
- D. Pre-Wash section

The larger Main Wash section automatically empties detergent into the dishwasher during the main wash. (See “Cycle Selection Charts.”)

- Use automatic dishwashing detergent only. Other detergents can produce excessive suds that can overflow out of the dishwasher and reduce washing performance.
- Add detergent just before starting a cycle.
- Store tightly closed detergent in a cool, dry place. Fresh automatic dishwasher detergent results in better cleaning.

NOTE: Do not use detergent if you have selected a rinse cycle.

Filling the dispenser

1. If the dispenser cover is closed, open the cover by pushing the cover latch.
2. Fill the Main Wash section with detergent. See “How much detergent to use.”
3. Fill the Pre-Wash section if needed. (See “Cycle Selection Charts.”)
4. Close the dispenser cover.

The cover will open during the cycle to dispense the detergent.

How much detergent to use

- The amount of detergent to use depends on the hardness of your water and the type of detergent. If you use too little, dishes won't be clean. If you use too much in soft water, glassware will etch.
- Water hardness can change over a period of time. Find out your water's hardness by asking your local water department, water softener company, or county extension agent.

Where to fill



Top of 3rd step (9 tsp or 45 mL)



Top of 2nd step (6 tsp or 30 mL)



Top of 1st step (3 tsp or 15 mL)

Soft to Medium Water (0-6 grains per U.S. gallon) [typical water softener water and some city water]

Soil Level	Main Wash	Pre-Wash
Lightly soiled/Pre-rinsed dish loads	3 tsp (15 mL) [top of 1st step]	3 tsp (15 mL) [top of 1st step]
Normally soiled dish loads	6 tsp (30 mL) [top of 2nd step]	6 tsp (30 mL) [top of 2nd step]
Heavily soiled dish loads	9 tsp (45 mL) [top of 3rd step]	6 tsp (30 mL) [top of 2nd step]

Medium to Hard Water (7-12 grains per U.S. gallon) [well water and some city water]

Soil Level	Main Wash	Pre-Wash
All soil types	9 tsp (45 mL) [top of 3rd step]	6 tsp (30 mL) [top of 2nd step]

NOTE: Fill amounts shown are for standard powdered detergent. Amounts may vary if you use liquid or concentrated powdered detergent. Tablet detergents should be placed in the main wash section of the detergent dispenser with the cover closed. Follow instructions on the package when using liquid dishwasher detergent, concentrated powdered detergent or tablet detergent.

IMPORTANT: See “Cycle Selection Charts” for which detergent dispenser sections to use with each cycle.

Rinse Aid Dispenser

Rinse aids prevent water from forming droplets that can dry as spots or streaks. They also improve drying by allowing water to drain off of the dishes during the final rinse by releasing a small amount of the rinse aid into the rinse water. Your dishwasher is designed to use a liquid rinse aid. Do not use a solid or bar-type rinse aid.

Checking the dispenser

Check the center of the fill indicator cap. Clear means it needs filling.

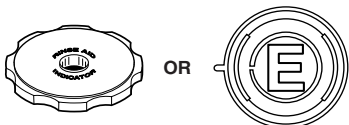

Or you can remove the fill indicator cap. If an “E” is visible, the dispenser is empty.

Filling the dispenser

The rinse aid dispenser holds 6 oz (175 mL) of rinse aid. Under normal conditions, this will last for about 3 months. You do not have to wait until the dispenser is empty to refill it. Try to keep it full, but be sure not to overfill it.

1. Make sure the dishwasher door is completely open.
2. Remove the fill indicator cap.
3. Add rinse aid. Fill to the smallest opening in the lower part of the dispenser. Overfilling can cause the rinse aid to leak out, and could cause oversudsing.

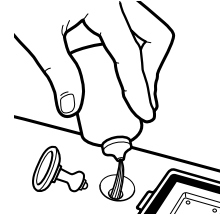

4. Clean up any spilled rinse aid with a damp cloth.
5. Replace the fill indicator cap. Close tightly.

Dishwasher Efficiency Tips

Hot water dissolves and activates the dishwashing detergent. Hot water also dissolves grease on dishes and helps glasses dry spot-free. For best dishwashing results, water should be 120°F (49°C) as it enters the dishwasher. Loads may not wash as well if the water temperature is too low. Water that is too hot can make some soils harder to remove and cause certain detergent ingredients not to function. If your water heater is located far from the dishwasher, it may be necessary to run the hot water at the faucet closest to the dishwasher to minimize the amount of cold water in the water line.

To check water temperature

1. Run hot water at the faucet closest to your dishwasher for at least 1 minute.
2. Place a candy or meat thermometer in a glass measuring cup.



3. Check the temperature on the thermometer as the water is running into the cup.

Additional efficiency tips

- To save water and energy and time, do not rinse dishes before putting them into the dishwasher.
- Use a low energy, quick, or short cycle whenever possible. These cycles use less hot water and energy than a normal cycle.
- Use a delay feature (on some models) to run your dishwasher during off-peak hours. Local utilities recommend avoiding heavy usage of energy at certain times of day.
- During the summer, run your dishwasher at night. This reduces daytime heat buildup in the kitchen.

- Use the energy-saving dry option whenever possible. Allow longer drying times (overnight) when using these options. Use a rinse aid to improve drying.
- Use cycles or options that add extra heat to the wash or rinse portion of the cycle only when needed.
- Run your dishwasher with full loads. Run a rinse cycle after meals until the dishwasher is full.
- If your home is equipped with a water softener, you may want to avoid starting the dishwasher during the regeneration of the softener, since this may contribute to poor wash performance.

Cycle Selection Charts

Press the desired cycle. Turn the cycle control knob to the desired cycle. If the door is latched, you will hear the cycles start and stop as the cycle control knob passes each cycle mark. This is normal and does not hurt the dishwasher. If you prefer, you can set the cycle control knob with the door unlatched.

To use Rinse & Hold, press any cycle and turn the cycle control knob to Rinse & Hold.

NOTE: Use the Air Dry option with the Rinse & Hold cycle.

A “●” shows what steps are in each cycle. Your model may have some or all of the cycles shown.

Temperatures indicate where extra heat is added. The cycle control knob pauses as the water heats.

Water usage is shown in U.S. gallons/liters.

This model meets the ENERGY STAR® guidelines for energy efficiency.

Cycle time includes dry time. An asterisk (*) by the cycle time indicates the cycle time might be longer depending on the temperature of the water entering the dishwasher. The cooler the water, the longer the cycle time. If the water is already hot enough, the cycle time will be as shown.

Pots & Pans

Use this cycle for hard-to-clean, heavily soiled pots, pans, casseroles, and regular tableware.



Use both detergent dispenser sections.

Wash	Rinse	Main Wash	Purge†	Final Rinse	Dry	Time (min)	Water Usage (gal/L)
● 140°F (60°C)	●	● 140°F (60°C)	●	● 140°F (60°C)	●	88*	9.1/34.4

Heavy

Use this cycle for heavily soiled loads.



Use both detergent dispenser sections.

Wash	Rinse	Main Wash	Purge†	Final Rinse	Dry	Time (min)	Water Usage (gal/L)
●		●	●	● 140°F (60°C)	●	72*	6.9/26.1

Normal

Use this cycle for loads with normal amounts of food soil. (The energy-usage label is based on this cycle.)



Use covered detergent dispenser section.

Wash	Rinse	Main Wash	Purge†	Final Rinse	Dry	Time (min)	Water Usage (gal/L)
		●	●	● 140°F (60°C)	●	62*	4.8/18.2

Light

Use this cycle for prerinsed or lightly soiled loads.



Use covered detergent dispenser section.

Wash	Rinse	Main Wash	Purge†	Final Rinse	Dry	Time (min)	Water Usage (gal/L)
		●	●	●	●	62*	4.8/18.2

Rinse & Hold

Use this rinse cycle for rinsing dishes, glasses, and silverware that will not be washed right away.



Do not use detergent with this cycle.

Wash	Rinse	Main Wash	Purge†	Final Rinse	Dry	Time (min)	Water Usage (gal/L)
	●					6	2.2/8.3

† A small amount of water runs through the pump to remove soil particles.

Canceling a Cycle

You can cancel a cycle at any time.

1. Turn the cycle control knob slowly clockwise until you hear water draining. Let the dishwasher drain completely.
 2. Open the door.
 3. Turn the cycle control knob to Off.
-

Changing a Cycle or Setting

You can change a cycle anytime during a cycle.

1. Lift the door latch to stop the cycle.
2. Turn the cycle control knob clockwise.
3. Check the detergent dispensers. They must be filled properly for the new cycle.

NOTE: Turning the cycle control knob can cause the covered detergent dispenser section to open and release the detergent. Check the covered section if the cycle uses detergent in both sections.

4. Close the door firmly until it latches. The dishwasher starts a new cycle.
-

Adding Items During a Cycle

You can add an item anytime before the main wash starts, or the cycle control knob reaches Normal wash.

1. Lift up the door latch to stop the cycle. Wait for the spraying action to stop before opening the door.
 2. Open the door and add the item.
 3. Close the door, but do not latch it. Wait 30 seconds for the air in the dishwasher to warm up. This reduces the amount of moisture escaping from the vent when restarting a cycle.
 4. Close the door firmly until it latches. The dishwasher resumes the cycle.
-

Option Selections

You can customize your cycles by pressing an option. If you change your mind, press RESET OPTIONS to turn the option off. Select a different option if desired.

You can change an option anytime before the selected option begins. For example, you can press an unheated drying option any time before drying begins.

After a wash cycle, the dishwasher remembers the options used and uses the same options in the next wash cycle, unless you select new options or press RESET OPTIONS.

Hi-Temp Wash

Select this option to heat the water to 140°F (60°C) in the main wash. This option adds heat and wash time. Heating the water helps improve washing results.

NOTE: The Pots & Pans cycle automatically uses this option. Hi-Temp Wash is an option with the Heavy and Normal wash cycles. This option does not work with the Light wash cycle.

Air Dry

Select this option to dry dishes without heat and save energy. The dishes take longer to dry and some spotting can occur.

For best drying, use a liquid rinse aid. Some items (such as plastics) may need towel drying.

NOTE: The dishwasher automatically heats the air in the dishwasher during the “dry” portion of the cycle unless you select Air Dry.

Reset Options

Select this option to change an option setting.

You can change option settings anytime during a cycle as long as the cycle has not passed the point where the option is used. For example, you can press Air Dry anytime before the cycle control knob reaches Dry.

1. Press RESET OPTIONS.
 2. Press 1 or more options.
-

Delay Hours

Use Delay Hours to run your dishwasher at a later time or during off-peak hours. You can add items to the load anytime during the delay countdown. After adding items, close the door firmly until it latches. The delay countdown will not continue if the door is not latched.

To delay the start

1. Close the door.
2. Select a wash cycle and option(s).
3. Turn the cycle control knob clockwise to the number of hours you want the dishwasher to delay the start.

NOTES:

- To cancel the delay, turn the cycle control knob to the desired cycle.
 - Rinse & Hold and the Normal Wash cycles cannot be delayed.
-

Using the Plate Warmer

Use the Plate Warmer cycle to warm serving dishes or dinner plates.

NOTE: Do not use the Air Dry option.

1. Close and latch the door.
 2. Turn the cycle control knob to Plate Warmer.
 3. Allow 8 minutes for the cycle to heat the dishware.
 4. Turn the cycle control knob to Off.
-

Drying System

During drying, you can see steam escaping through the vent at the upper left corner of the door. This is normal as the heat dries your dishes.

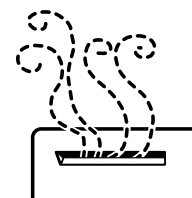

IMPORTANT: The vapor is hot. Do not touch the vent during drying.

Overfill Protection Float

The overfill protection float (in the front right corner of the dishwasher tub) keeps the dishwasher from overflowing. It must be in place for the dishwasher to operate.



Check under the float for objects that may keep the protector from moving up or down.

WASHING SPECIAL ITEMS

If you have doubts about washing a particular item, check with the manufacturer to see if it is dishwasher safe.

Material	Dishwasher Safe?/Comments
Aluminum	Yes High water temperature and detergents can affect finish of anodized aluminum.
Disposable Aluminum	No Do not wash throwaway aluminum pans in the dishwasher. These might shift during washing and transfer black marks to dishes and other items.
Bottles and Cans	No Wash bottles and cans by hand. Labels attached with glue can loosen and clog the spray arms or pump and reduce washing performance.
Cast Iron	No Seasoning will be removed, and iron will rust.
China/ Stoneware	Yes Always check manufacturer's recommendations before washing. Antique, hand-painted, or over-the-glaze patterns may fade. Gold leaf can discolor or fade.
Crystal	Yes Always check manufacturer's recommendations before washing. Some types of leaded crystal can etch with repeated washing.
Gold	No Gold-colored flatware will discolor.
Glass	Yes Milk glass yellows with repeated dishwasher washing.
Hollow-Handle Knives	No Handles of some knives are attached to the blade with adhesives which can loosen if washed in the dishwasher.

Material	Dishwasher Safe?/Comments
Pewter, Brass, Bronze	No High water temperatures and detergent can discolor or pit the finish.
Disposable Plastics	No Cannot withstand high water temperatures and detergents.
Plastics	Yes Always check manufacturer's recommendations before washing. Plastics vary in their capacity to withstand high temperatures and detergents. Load plastics in top rack only.
Stainless Steel	Yes Run a rinse cycle if not washing immediately. Prolonged contact with food containing salt, vinegar, milk products, or fruit juice can damage finish.
Sterling Silver or Silver Plate	Yes Run a rinse cycle if not washing immediately. Prolonged contact with food containing salt, acid, or sulfide (eggs, mayonnaise, and seafood) can damage finish.
Tin	No Can rust.
Wooden Ware	No Wash by hand. Always check manufacturer's instructions before washing. Untreated wood can warp, crack, or lose its finish.

DISHWASHER CARE

Cleaning

Cleaning the exterior

In most cases, regular use of a soft, damp cloth or sponge and a mild detergent is all that is necessary to keep the outside of your dishwasher looking nice and clean. If your dishwasher has a stainless steel exterior, a stainless steel cleaner is recommended.

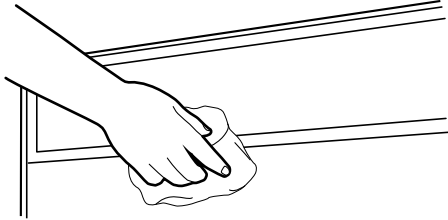

Cleaning the interior

Hard water minerals can cause a white film to build up on the inside surfaces, especially just beneath the door area.

Do not clean the dishwasher interior until it has cooled. Wear rubber gloves. Do not use any type of cleanser other than dishwasher detergent because it may cause foaming or sudsing.

To clean interior

Make a paste with powdered dishwasher detergent on a damp sponge and clean.

OR

Use liquid automatic dishwasher detergent and clean with a damp sponge.

OR

See the vinegar rinse procedure in "Spotting and filming on dishes" in "Troubleshooting."

NOTE: Run a normal cycle with detergent after cleaning the interior.

Drain Air Gap

Check the drain air gap anytime your dishwasher isn't draining well.

Some state or local plumbing codes require the addition of a drain air gap between a built-in dishwasher and the home drain system. If a drain is clogged, the drain air gap protects your dishwasher from water backing up into it.

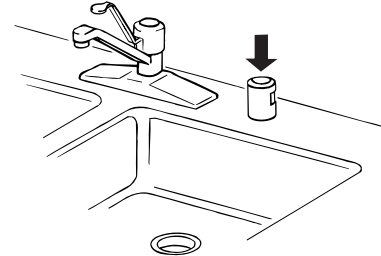

The drain air gap is usually located on top of the sink or countertop near the dishwasher. To order a drain air gap, contact your local dealer; or call us or your nearest designated service center and ask for Part Number 300096.

NOTE: The drain air gap is an external plumbing device that is not part of your dishwasher. The warranty provided with your dishwasher does not cover service costs directly associated with the cleaning or repair of the external drain air gap.

To clean the drain air gap

Clean the drain air gap periodically to ensure proper drainage of your dishwasher. Follow the cleaning instructions provided by the manufacturer. With most types, you lift off the chrome cover. Unscrew the plastic cap. Then check for any soil buildup. Clean if necessary.

Storing

Storing for the summer

Protect your dishwasher during the summer months by turning off the water supply and power supply to the dishwasher.

Winterizing your dishwasher

Protect your dishwasher and home against water damage due to freezing water lines. If your dishwasher is left in a seasonal dwelling or could be exposed to near freezing temperatures, have your dishwasher winterized by authorized service personnel.

TROUBLESHOOTING

First try the solutions suggested here and possibly avoid the cost of a service call...

Dishwasher is not operating properly

■ Dishwasher does not run or stops during a cycle

Is the door closed tightly and latched?

Is the right cycle selected? Refer to the “Cycle Selection Charts.”

Is there power to the dishwasher? Has a household fuse blown, or has a circuit breaker tripped?

Has the motor stopped due to an overload? The motor automatically resets itself within a few minutes. If it does not restart, call for service.

Is the water shutoff valve (if installed) turned on?

■ Dishwasher will not fill

Is the overflow protection float able to move up and down freely? Press down to release.

■ Water remains in the dishwasher

Is the cycle complete?

■ Detergent remains in the covered section of the dispenser

Is the cycle complete?

Is the detergent lump-free? Replace detergent if necessary.

Is the bottom rack installed properly with the bumpers in the front? Refer to the “Parts and Features” section. Reinstall the rack if necessary.

■ White residue on the front of the access panel

Was too much detergent used? Refer to the “Detergent Dispenser” section.

Is the brand of detergent making excess foam? Try a different brand to reduce foaming and eliminate buildup.

■ Odor in the dishwasher

Are dishes washed only every 2 or 3 days? Run a rinse cycle once or twice a day until you have a full load.

Does the dishwasher have a new plastic smell? Run a vinegar rinse as described in “Spotting and filming on dishes” later in this Troubleshooting guide.

■ Condensation on the kitchen counter (built-in models)

Is the dishwasher aligned with the countertop? Moisture from the vent in the dishwasher console can form on the counter. Refer to the Installation Instructions for more information.

Dishes are not completely clean

■ Food soil left on the dishes

Is the dishwasher loaded correctly? Refer to the “Dishwasher Loading” section.

Is the water temperature too low? For best dishwashing results, water should be 120°F (49°C) as it enters the dishwasher. Refer to the “Dishwasher Efficiency Tips” section.

Did you use the correct amount of fresh detergent? Use recommended dishwasher detergents only. Refer to the “Detergent Dispenser” section. Do not use less than 1 tb (15 g) per load. Detergent must be fresh to be effective. Store detergent in a cool, dry area. Heavy soil and/or hard water generally require extra detergent.

Is detergent caked in dispenser? Use fresh detergent only. Do not allow detergent to sit for several hours in a wet dispenser. Clean dispenser when caked detergent is present.

Is the pump or spray arm clogged by labels from bottles and cans?

Is the home water pressure high enough for proper dishwasher filling? Home water pressure should be 20 to 120 psi (138 to 828 kPa) for proper dishwasher fill. A booster pump on the water supply can be added if pressure is too low.

Are high suds slowing the wash arm? Do not use soap or laundry detergents. Use recommended dishwasher detergents only.

■ Dishwasher door will not close

Is the bottom rack in backwards? The rack bumpers must face the dishwasher door.

Spots and stains on dishes

■ Spotting and filming on dishes

Is your water hard or is there a high mineral content in your water? Conditioning the final rinse water with a liquid rinse aid helps eliminate spotting and filming. Keep the rinse aid dispenser filled.

Is the water temperature too low? For best dishwashing results, water should be 120°F (49°C) as it enters the dishwasher. Refer to the “Dishwasher Efficiency Tips” section.

Did you use the correct amount of effective detergent? Use recommended dishwasher detergents only. Refer to the “Detergent Dispenser” section. Do not use less than 1 tb (15 g) per load. Detergent must be fresh to be effective. Store detergent in a cool, dry area. Heavy soil and/or hard water generally require extra detergent.

Is the home water pressure high enough for proper dishwasher filling? Home water pressure should be 20 to 120 psi (138 to 828 kPa) for proper dishwasher fill. A booster pump on the water supply can be added if pressure is too low.

NOTE: To remove spots and film from dishes, try a white vinegar rinse. This procedure is intended for occasional use only. Vinegar is an acid, and using it too often could damage your dishwasher.

1. Wash and rinse dishes. Use an air-dry or an energy-saving dry option. Remove all silverware or metal items.
2. Put 2 cups (500 mL) white vinegar in a glass or dishwasher-safe measuring cup on the bottom rack.
3. Run the dishwasher through a complete washing cycle using an air-dry or an energy-saving dry option. Do not use detergent. Vinegar will mix with the wash water.

■ **Silica film or etching (silica film is a milky, rainbow-colored deposit; etching is a cloudy film)**

Sometimes there is a water/chemical reaction with certain types of glassware. This is usually caused by some combination of soft or softened water, alkaline washing solutions, insufficient rinsing, overloading the dishwasher, and the heat of drying. It might not be possible to prevent the problem, except by hand washing.

To slow this process use a minimum amount of detergent but not less than 1 tb (15 g) per load. Use a liquid rinse aid and underload the dishwasher to allow thorough rinsing. Silica film and etching are permanent and cannot be removed. Do not use heated drying.

■ **White spots on cookware with nonstick finish**

Has the dishwasher detergent removed cookware seasoning? Reseason cookware after washing in the dishwasher.

■ **Brown stains on dishes and dishwasher interior**

Does your water have high iron content? Rewash dishes using 1-3 tsp (5-15 mL) of citric acid crystals added to the covered section of the detergent dispenser. Do not use detergent. Follow with a normal wash cycle with detergent. If treatment is needed more often than every other month, the installation of an iron removal unit is recommended.

■ **Black or gray marks on dishes**

Are aluminum items rubbing dishes during washing? Disposable aluminum items can break down in the dishwasher and cause marking. Hand wash these items. Remove aluminum markings by using a mild abrasive cleaner.

■ **Orange stains on plastic dishes or dishwasher interior**

Are large amounts of tomato-based foods on dishes placed in the dishwasher? Stains can gradually fade over time. Regular use of heated drying will slow fading. Stains will not affect dishwasher performance. Regular use of a rinse cycle and an air-dry or energy-saving dry option will reduce the likelihood of staining.

Dishes do not dry completely

■ **Dishes are not dry**

Did you load your dishwasher to allow proper water drainage? Do not overload. Refer to the “Dishwasher Loading” section. Use a liquid rinse aid to speed drying.

Are the plastics wet? Plastics often need towel drying.

Is the rinse aid dispenser empty? Refer to the “Rinse Aid Dispenser” section.

Did you use an air-dry or energy-saving dry option? Use a heated drying option for dryer dishes.

Dishes are damaged during a cycle

■ **Chipping of dishes**

Did you load the dishwasher properly? Load the dishes and glasses so they are stable and do not strike together from washing action. Minimize chipping by moving the rack in and out slowly.

NOTE: Antiques, feather-edged crystal, and similar types of china and glassware might be too delicate for automatic dishwashing. Wash by hand.

Noises

■ **Grinding, grating, crunching or buzzing sounds**

A hard object has entered the wash module (on some models). When the object is ground up, the sound should stop. If the noise persists after a complete cycle, call for service.

ASSISTANCE OR SERVICE

Before calling for assistance or service, please check “Troubleshooting.” It may save you the cost of a service call. If you still need help, follow the instructions below.

When calling, please know the purchase date and the complete model and serial number of your appliance. This information will help us to better respond to your request.

If you need replacement parts

If you need to order replacement parts, we recommend that you use only FSP® factory specified parts. These parts will fit right and work right because they are made with the same precision used to build every new ESTATE® appliance.

To locate FSP® replacement parts in your area, call us or your nearest designated service center.

Call the Estate Customer eXperience Center toll free: **1-800-253-1301**.

Our consultants provide assistance with:

- Features and specifications on our full line of appliances.
- Installation information.
- Use and maintenance procedures.

- Accessory and repair parts sales.
- Specialized customer assistance (Spanish speaking, hearing impaired, limited vision, etc.).
- Referrals to local dealers, repair parts distributors, and service companies. Whirlpool designated service technicians are trained to fulfill the product warranty and provide after-warranty service, anywhere in the United States.

To locate the Whirlpool designated service company in your area, you can also look in your telephone directory Yellow Pages.

For further assistance

If you need further assistance, you can write to us with any questions or concerns at:

Estate Brand Home Appliances
Customer eXperience Center
553 Benson Road
Benton Harbor, MI 49022-2692

Please include a daytime phone number in your correspondence.

ESTATE® DISHWASHER WARRANTY

ONE-YEAR FULL WARRANTY

For one year from the date of purchase, when this dishwasher is operated and maintained according to instructions attached to or furnished with the product, Whirlpool Corporation will pay for FSP® replacement parts and repair labor costs to correct defects in materials or workmanship. Service must be provided by a Whirlpool designated service company.

TEN-YEAR FULL WARRANTY ON DURAPERM™ TUB OR INNER DOOR

For ten years from the date of purchase, when this dishwasher is operated and maintained according to instructions attached to or furnished with the product, Whirlpool Corporation will pay for FSP® replacement parts and repair labor costs for the DURAPERM™ tub or inner door if either develops a water leak resulting from defective materials or workmanship. Service must be provided by a Whirlpool designated service company.

Whirlpool Corporation will not pay for:

1. Service calls to correct the installation of your dishwasher, to instruct you how to use your dishwasher, to replace house fuses or correct house wiring or plumbing.
 2. Repairs when your dishwasher is used in other than normal, single-family household use.
 3. Damage resulting from accident, alteration, misuse, abuse, fire, floods, acts of God, improper installation, installation not in accordance with local electrical and plumbing codes, or use of products not approved by Whirlpool Corporation.
 4. Replacement parts or repair labor costs for units operated outside the United States.
 5. Pickup and delivery. This product is designed to be repaired in the home.
 6. Repairs to parts or systems resulting from unauthorized modifications made to the appliance.
-

WHIRLPOOL CORPORATION SHALL NOT BE LIABLE FOR INCIDENTAL OR CONSEQUENTIAL DAMAGES.

Some states do not allow the exclusion or limitation of incidental or consequential damages, so this exclusion or limitation may not apply to you. This warranty gives you specific legal rights, and you may also have other rights which may vary from state to state.

Outside the 50 United States, this warranty does not apply. Contact your authorized Estate dealer to determine if another warranty applies.

If you need service, first see "Troubleshooting." Additional help can be found by checking "Assistance or Service," or by calling our Customer eXperience Center at **1-800-253-1301**, from anywhere in the U.S.A., or write: Estate Brand Home Appliances, Customer eXperience Center, 553 Benson Road, Benton Harbor, MI 49022-2692.

7/04

Keep this book and your sales slip together for future reference. You must provide proof of purchase or installation date for in-warranty service.

Write down the following information about your dishwasher to better help you obtain assistance or service if you ever need it. You will need to know your complete model number and serial number. You can find this information on the model and serial number label/plate, located on your appliance as shown in "Parts and Features."

Dealer name _____
Address _____
Phone number _____
Model number _____
Serial number _____
Purchase date _____