

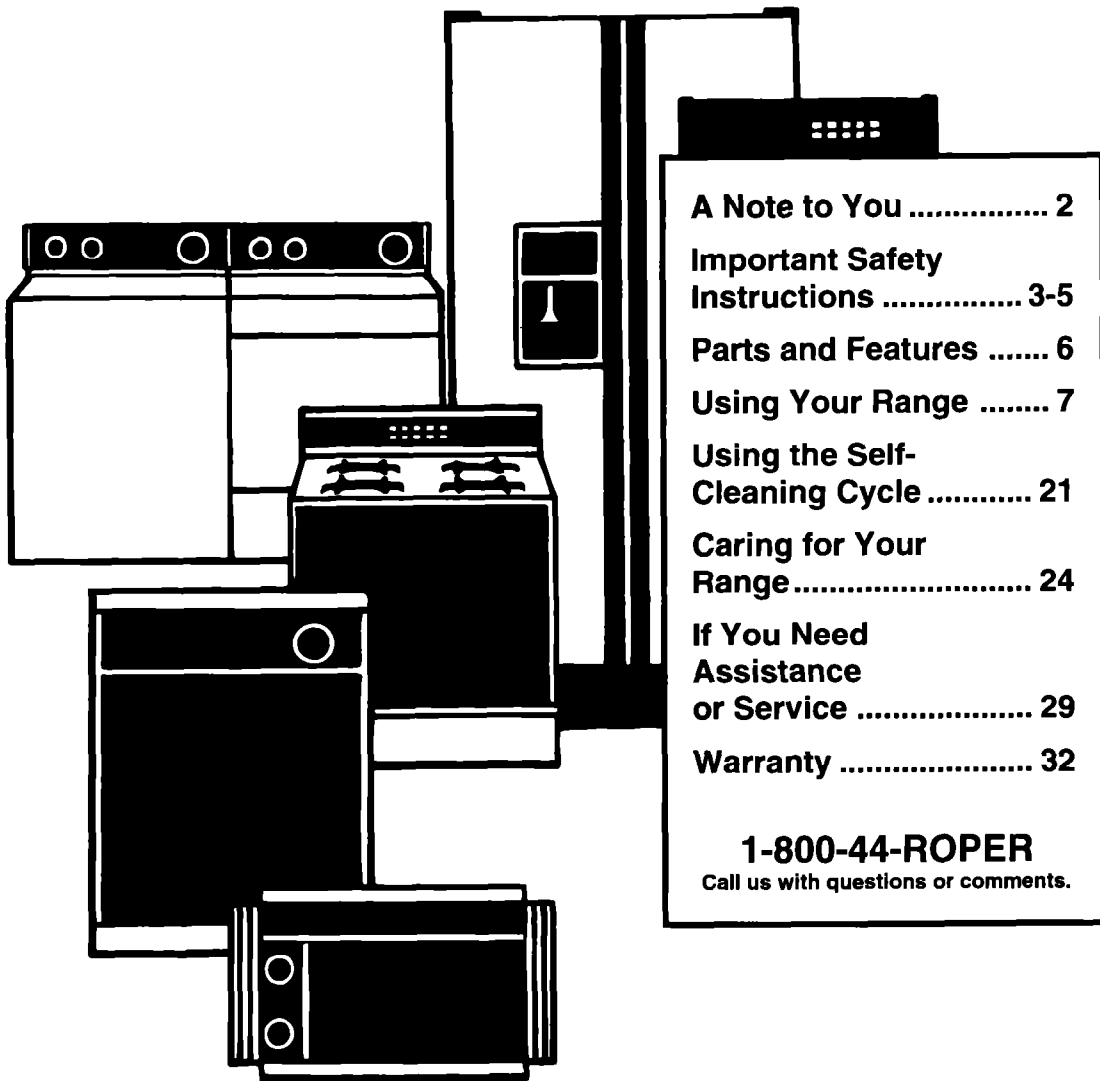

Home Appliances

Use And Care

G U I D E



| | |
|---|-----|
| A Note to You | 2 |
| Important Safety Instructions | 3-5 |
| Parts and Features | 6 |
| Using Your Range | 7 |
| Using the Self-Cleaning Cycle | 21 |
| Caring for Your Range | 24 |
| If You Need Assistance or Service | 29 |
| Warranty | 32 |
| 1-800-44-ROPER | |
| Call us with questions or comments. | |

SELF-CLEANING ELECTRIC RANGE

PART NO. 3187697 Rev. B

10/95

MODEL FES364B

A Note to You

Thank you for buying a ROPER® appliance.

Your ROPER range gives you all the functionality of name brand appliances at a value price. To ensure that you enjoy years of trouble-free operation, we developed this Use and Care Guide. It is full of valuable information about how to operate and maintain your appliance properly and safely. Please read it carefully. Also, please complete and mail the Ownership Registration Card provided with your appliance. This will help us notify you about any new information on your appliance.

Your safety is important to us.

This guide contains warning symbols and statements. Please pay special attention to these symbols and follow any instructions given. Here is a brief explanation of the use of the warning symbol.

⚠ WARNING

This symbol will help alert you to such dangers as fire, electrical shock, burns, and personal injury.

Our toll-free number, 1-800-44-ROPER (1-800-447-6737), is available 24 hours a day.

If you ever have a question concerning your appliance's operation, or if you need service, first see "If You Need Assistance or Service" on page 29. If you need further help, feel free to call us. When calling, you will need to know your appliance's complete model number and serial number. You can find this information on the model and serial number plate (see diagram on page 6). For your convenience, we have included a handy place below for you to record these numbers, the purchase date from the sales slip, and your dealer's name and telephone number. Keep this book and the sales slip together in a safe place for future reference.

Model Number _____

Dealer Name _____

Serial Number _____

Dealer Phone _____

Purchase Date _____

Important Safety Instructions

⚠️ WARNING

To reduce the risk of fire, electrical shock, injury to persons, or damage when using the range, follow basic precautions, including the following:

General

- Read all instructions before using the range.
- Install or locate the range only in accordance with the provided Installation Instructions. The range must be installed by a qualified installer. The range must be properly connected to electrical supply and grounded.



- **WARNING:** To reduce the risk of tipping the appliance, the appliance must be secured by a properly installed anti-tip bracket. To check if the bracket is installed properly, see "The anti-tip bracket" on page 20.
- **CAUTION:** Do not store things children might want above the range. Children could be burned or injured while climbing on it.
- Do not leave children alone or unattended in area where the range is in use. They should never be allowed to sit or stand on any part of the range. They could be burned or injured.
- Do not operate the range if it is damaged or not working properly.
- Do not use the range for warming or heating the room. Persons could be burned or injured, or a fire could start.

- Use the range only for its intended use as described in this manual.



- Do not touch surface units, areas near units, heating elements, or interior surfaces of oven. Surface units and heating elements could be hot even though they are dark in color. Areas near surface units and interior surfaces of an oven become hot enough to cause burns. During and after use, do not touch, or let clothing or other flammable materials contact surface units, areas near units, heating elements, or interior surfaces of oven until they have had sufficient time to cool. Other surfaces of the range, such as the oven vent opening, the surface near the vent opening, the cooktop, and the oven door could also become hot enough to cause burns.



- Do not wear loose or hanging garments when using the range. They could ignite if they touch a hot surface unit and you could be burned.

IMPORTANT SAFETY INSTRUCTIONS

- Use only dry pot holders. Moist or damp pot holders on hot surfaces could result in burns from steam. Do not let pot holder touch hot heating elements. Do not use a towel or bulky cloth for a pot holder. It could catch on fire.
- Keep range vents unobstructed.
- Do not heat unopened containers. They could explode. The hot contents could cause burns and container particles could cause injury.
- Use only utensils approved for oven use. Follow utensil manufacturer's instructions, especially when using glass or plastic utensils.
- Do not store flammable materials on or near the range. The fumes could create an explosion and/or fire hazard.
- Check to be sure glass cooking utensils are safe for use on the range. Only certain types of glass, glass-ceramic, ceramic, earthenware, or other glazed utensils are suitable for cooktops without breaking due to the sudden change in temperature.
- Never leave surface units unattended at high heat settings. A boilover could result and cause smoking and greasy spillovers that could ignite.



- Turn pan handles inward, but not over other surface units. This will help reduce the chance of burns, igniting of flammable materials, and spills due to bumping of the pan.

When using the cooktop

- Do not cook on a broken cooktop. If cooktop should break, cleaning solutions and spillovers could penetrate the broken cooktop and create a risk of electrical shock. Contact a qualified technician immediately.
- Select a pan with a flat bottom that is about the same size as the surface unit. If pan is smaller than the surface unit, some of the heating element will be exposed and could result in the igniting of clothing or pot holders. Correct pan size also improves cooking efficiency.

When using the oven

- Always position oven rack(s) in desired location while oven is cool. If a rack must be removed while oven is hot, do not let pot holder contact hot heating element in oven.
- Use care when opening oven door. Let hot air or steam escape before removing or replacing food.

IMPORTANT SAFETY INSTRUCTIONS

Grease

- Grease is flammable. Do not allow grease to collect around cooktop or in vents. Wipe spill-overs immediately.



- Do not use water on grease fires. Never pick up a flaming pan. Smother flaming pan on range by covering with a well-fitted lid, cookie sheet, or flat tray. Flaming grease outside of pan can be extinguished with baking soda or, if available, a multipurpose dry chemical or foam-type extinguisher.

Care and cleaning

- Clean cooktop with care. Some cleaners could produce noxious fumes if applied to a hot surface. If a wet paper towel is used to wipe spills on a hot cooking area, be careful to avoid steam burns.
- Small amounts of formaldehyde and carbon monoxide are given off in the Self-Cleaning cycle from fiberglass insulation and food decomposition. Significant exposure to these substances could cause cancer or reproductive harm. Exposure can be minimized by venting with a hood or open window and wiping out excess food spills prior to self-cleaning.



- Do not use oven cleaners. No commercial oven cleaner or oven liner protective coating of any kind should be used in or around any part of the oven.
- Before self-cleaning the oven, remove broiler pan, broiler grid, oven racks, and other utensils. Do not use your oven to clean miscellaneous parts unless you are instructed to do so in this Use and Care Guide.
- Do not clean door heat seal. It is essential for a good seal. Care should be taken not to rub, damage, or move the seal. Clean only parts recommended in this Use and Care Guide.
- Do not repair or replace any part of the range unless specifically recommended in this manual. All other servicing should be referred to a qualified technician.
- Disconnect the electrical supply before servicing the range.

– SAVE THESE INSTRUCTIONS –

Parts and Features

This section contains captioned illustrations of your range. Use them to become familiar with the location and appearance of all parts and features.

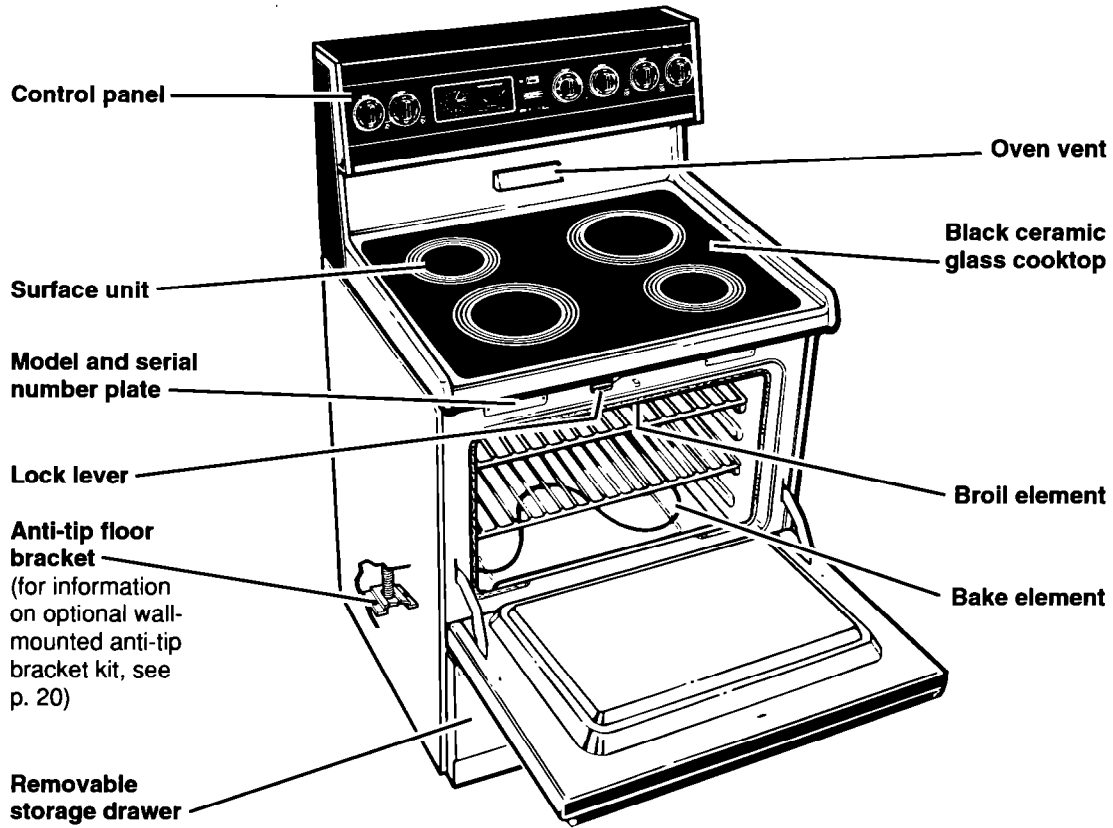

Control panel

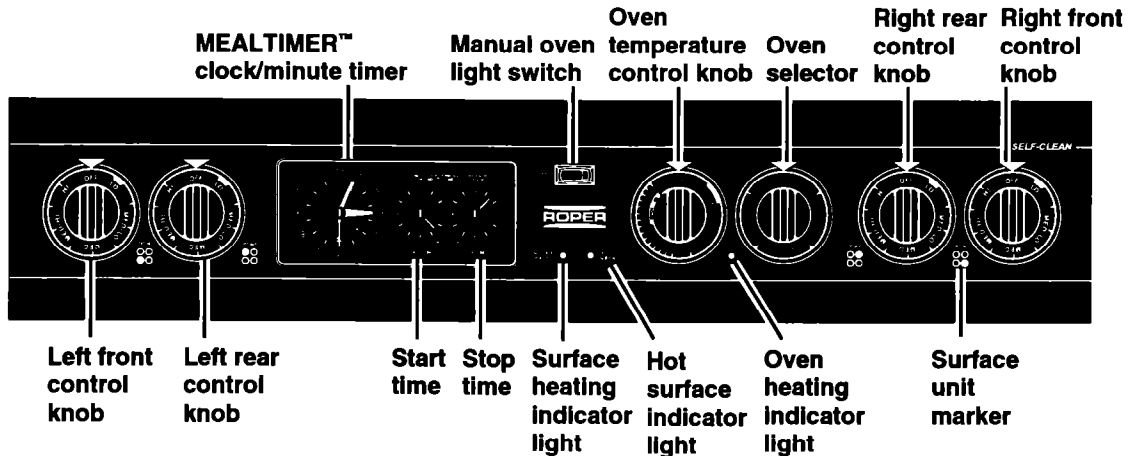

Using Your Range

| In This Section | | Page | Page |
|--|----|----------------------------------|------|
| Using the surface units | 7 | Broiling | 14 |
| Positioning racks and pans | 9 | Broiling tips | 15 |
| For best air circulation | 9 | Energy saving tips | 16 |
| Using aluminum foil for baking | 10 | Using the MEALTIMER™ clock | 17 |
| Setting the clock | 11 | The oven vent | 18 |
| Using the Minute Timer | 11 | The storage drawer | 19 |
| Baking/roasting | 12 | The anti-tip bracket | 20 |
| Adjusting the oven temperature control | 13 | Optional door panel pac | 20 |

To obtain the best cooking results possible, you must operate your range properly. This section gives you important information for efficient and safe use of your range.

Using the surface units

⚠ WARNING



Fire Hazard

Turn all controls off when done cooking.

Failure to do so can result in death, fire, or burns.

Push in control knobs before turning them to a setting. You can set them anywhere between HI and OFF.

Surface unit markers

The solid dot in the surface unit marker shows which surface unit is turned on by that knob.

Surface heating indicator light

The SURFACE HEATING Indicator Light on the control panel will glow when a surface unit is turned on.

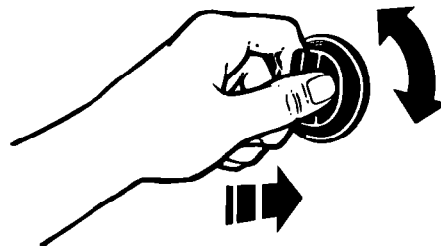

continued on next page

USING YOUR RANGE

Hot surface indicator light

The Hot Surface Indicator Light on the control panel will glow when a surface unit becomes too hot to touch. The Indicator Light will continue to glow as long as the surface unit is too hot to touch, even after it is turned off.

Until you get used to the settings, use the following as a guide. For best results, start cooking at the high setting; then turn the control knob down to continue cooking.

| SETTING | RECOMMENDED USE |
|---------|--|
| HI | <ul style="list-style-type: none"> • To start foods cooking. • To bring liquids to a boil. |
| MED-HI | <ul style="list-style-type: none"> • To hold a rapid boil. • To fry chicken or pancakes. |
| MED | <ul style="list-style-type: none"> • For gravy, pudding, and icing. • To cook large amounts of vegetables. |
| MED-LO | <ul style="list-style-type: none"> • To keep food cooking after starting it on a higher setting. |
| LO | <ul style="list-style-type: none"> • To keep food warm until ready to serve. |

Using the ceramic glass cooktop

Cooking on the ceramic glass cooktop is almost the same as cooking on coil surface units. There are, however, a few differences:

- **The surface unit will glow red** when it is turned on. You will see the element cycling on (glowing red) and off – even on HIGH setting – to maintain the proper temperature setting you have selected.
- **Sliding metal pans** on ceramic glass cooktop surface could leave marks. Wiping off the cooktop before and after each use will help keep the surface free from stains and provide the most even heating. See pages 25 and 26 for care and cleaning suggestions.

Cookware tips

- **Select a pan** that is about the same size as the surface unit.
- **NOTE: For best results and greater energy efficiency,** use only flat-bottomed cookware that makes good contact with the surface units. Cookware with rounded, warped, ribbed (such as some porcelain enamelware), or dented bottoms could cause uneven heating and poor cooking results.

You can, however, use the newer cookware available with slightly indented bottoms or very small expansion channels. This cookware is specially designed to provide the good contact needed for best cooking results.

Also, woks, canners, and teakettles with flat bottoms suitable for use on your cooktop are now available in most stores that sell housewares.

- **The pan** should have straight sides and a tight-fitting lid.
- **Choose medium to heavy gauge** (thickness) pans that are fairly lightweight.
- **The pan material** (metal or glass) affects how fast heat transfers from the surface unit through the pan material and how evenly heat spreads over the pan bottom. Choose pans that provide the best cooking results.
- **Handles** should be made of sturdy, heat-resistant material and be securely attached to the pan.
- **With your hand,** feel the bottom of your pans while they are cool for nicks and scratches. Nicks and scratches on pan bottoms will scratch the ceramic glass cooktop.
- **Make sure bottoms** of pans are clean and dry before using on cooktop.
- **Avoid spillovers** on cooktop. Use pans with tall sides.
- **Do not** cook food directly on cooktop.
- **Do not leave** an empty utensil, or one which has boiled dry, on a hot surface unit. The utensil could overheat and could damage the utensil or surface unit.

Home canning information

- **Use the largest surface unit** for best results.
- **Start with hot water.** This reduces the time the control is set on high. Reduce heat setting to lowest position needed to keep water boiling.
- **Refer to your canner manual** for specific instructions.

Positioning racks and pans

General guidelines

- **Always position oven rack(s)** in desired location before turning oven on.
- **To move rack(s)**, lift rack(s) at front and pull out.
- **Be sure** the rack(s) is level.
- **If rack(s) must be moved** while oven is hot, use pot holders or oven mitts to protect hands.
- **For baking/roasting with one rack**, place the rack so the top of the food will be centered in the oven.
- **When baking on two racks**, arrange racks on the bottom and third level from the bottom.

Rack placement for specific foods:

| FOOD | RACK POSITION |
|---|---------------------------------------|
| Frozen pies, large roasts, turkeys, angel food cakes | Lowest level or 2nd level from bottom |
| Bundt cakes, most quick breads, yeast breads, casseroles, meats | 2nd level from bottom |
| Cookies, biscuits, muffins, cakes, nonfrozen pies | 2nd or 3rd level from bottom |

NOTE: For recommended rack placement when broiling, see "Broiling rack position chart" on page 15.

For best air circulation

Hot air must circulate around the pans in the oven for even heat to reach all parts of the oven. This results in better baking.

- **Place** the pans so that one is not directly over the other.
- **For best results, allow** 1½ to 2 inches (4-5 cm) of space around each pan and between pans and oven walls. There must be a minimum space of 1 inch (3 cm).
- **Use** only one cookie sheet in the oven at one time.

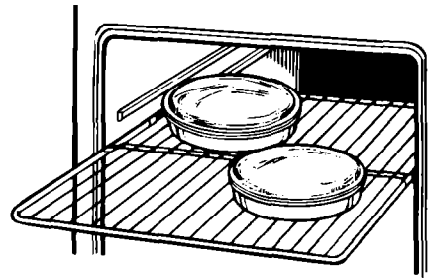

Use the following as a guide to determine where to place the pans:

One pan

Place in the center of the oven rack.

Two pans

Place in opposite corners of the oven rack.

Three or four pans

Place in opposite corners on each oven rack. Stagger pans so no pan is directly over another.

USING YOUR RANGE

Using aluminum foil for baking

Use aluminum foil to catch spillovers from pies or casseroles:

- **Place** the foil on the oven rack below the rack with the food. **Turn up** foil edges and **make sure** foil is about 1 inch (3 cm) larger all around than the dish holding the food.
- **Do not cover** the entire rack with aluminum foil. It will reduce air circulation and cause poor cooking results.
- **Do not line** oven bottom or entire oven rack with foil or other liners. Poor baking will result.

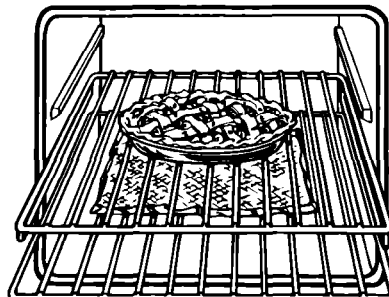

Setting the clock

Push in and turn the Minute Timer Knob to set the clock.

1. **Push in Minute Timer Knob and turn clockwise** until clock shows the correct time of day.

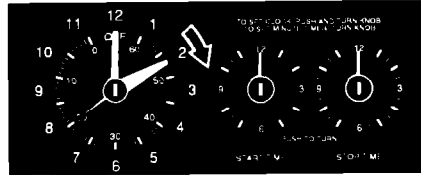

2. **Let the Minute Timer Knob pop out. Turn clockwise** until Minute Timer hand points to OFF. **The clock setting will change if you push in the knob when turning.**

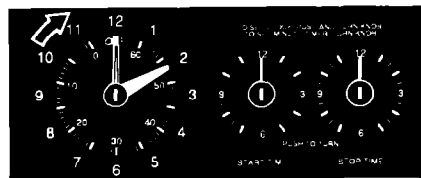

Using the Minute Timer

The Minute Timer does not start or stop the oven. It works like a kitchen timer. Set it in minutes up to an hour. You will hear a buzzer when the set time is up.

NOTE: Do not push in the knob when setting the Minute Timer or when stopping the buzzer. Pushing in and turning the Minute Timer Knob changes the clock setting.

1. **Without pushing it in, turn** the Minute Timer Knob **counterclockwise** until the timer hand passes the setting you want.

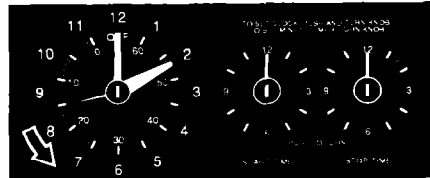

2. **Without pushing it in, turn** the knob back to the setting you want. **When the time is up, a buzzer will sound. To stop the buzzer, turn** the Minute Timer hand to OFF.

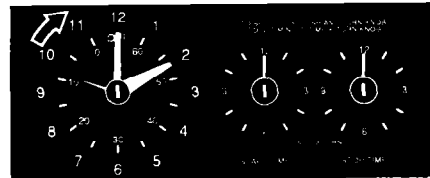

USING YOUR RANGE

Baking/roasting

1. **Position** the rack(s) properly **before** turning on the oven. **To change rack position, lift** rack at front and **pull out**. For further information, **see** "Positioning racks and pans" on page 9.

2. **Set** the Oven Selector to **BAKE**.

3. **Set** the Oven Temperature Control Knob to the baking/roasting temperature you want. The **OVEN HEATING Indicator Light** will come on. The oven is preheated when the **OVEN HEATING Indicator Light** first goes off.

NOTE: Do not preheat oven when roasting or cooking items such as casseroles.

4. **Put** food in the oven. During baking/roasting, the elements will turn on and off to maintain the temperature setting. The **OVEN HEATING Indicator Light** will turn on and off with the elements.

NOTE: The top element helps heat during baking/roasting, but does not turn red.

5. **When baking/roasting is done, turn both** the Oven Selector and the Oven Temperature Control Knob to **OFF**. The **OVEN HEATING Indicator Light** will go off.

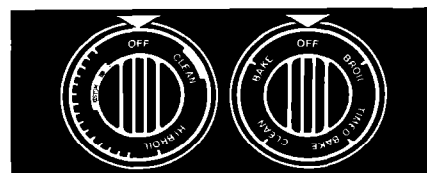
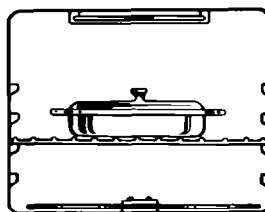
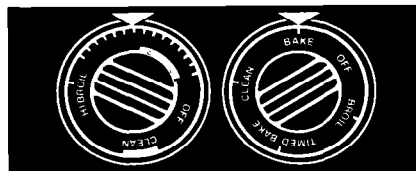

Adjusting the oven temperature control

Although your new oven is properly adjusted to provide accurate temperatures, it may cook faster or slower than your old oven.

If, after using the oven for a period of time, you are not satisfied with the baking/roasting results, you can change the temperature calibration by following these steps:

1. **Make sure** the Oven Temperature Control Knob is turned to the off position. **Pull** knob straight off and **flip** it over.

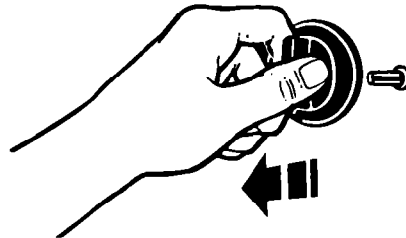

2. **Loosen** the locking screws inside the control knob. **Note the position of the notches.**
3. **To lower the temperature, hold** knob handle firmly and **move** the tooth a notch **counterclockwise**. Each notch equals about 5°F (2.5°C).
4. **To raise the temperature, hold** knob handle firmly and **move** the tooth a notch **clockwise**. Each notch equals about 5°F (2.5°C).
5. **Tighten** the locking screws and **replace** the control knob.

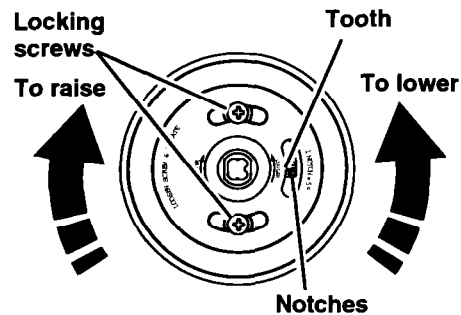

USING YOUR RANGE

Broiling

1. **Position** the rack before turning the oven on. See "Broiling rack position chart" on page 15.
2. **Put** the broiler pan and food on the rack.
3. **Close** the door to the Broil Stop position (open about 4 inches [10 cm]). The door will stay open by itself.
4. **Set** the Oven Selector and Oven Temperature Control Knob to BROIL. The OVEN HEATING Indicator Light will come on.
NOTE: Do not preheat oven when broiling.
5. **When broiling is done, turn both** the Oven Selector and Oven Temperature Control Knob to OFF. The OVEN HEATING Indicator Light will go off.

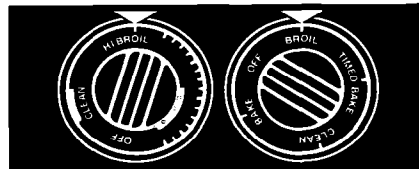

Custom broil

- **If food is cooking too fast**, turn the Oven Temperature Control Knob **counterclockwise** until the OVEN HEATING Indicator Light goes off.
- **If you want the food to broil slower from the start**, set the Oven Temperature Control Knob between 170°F and 325°F (77°C and 163°C). These temperature settings allow the broil heating element to cycle and to slow cooking. The lower the temperature, the slower the cooking.
- **Fish and chicken** are some foods that may cook better if you use lower broiling temperatures.

The Oven Selector must be on BROIL for all broiling temperatures.

NOTE: Leave the oven door partly open whenever using the oven to broil. This allows the oven to maintain proper temperatures.

Broiling rack position chart

| RACK POSITION FROM BOTTOM | TYPE OF FOOD/ DONENESS |
|---------------------------|---|
| 4 | Hamburger patties and thin steaks, 1/2" thick or less |
| 3 | Quickly searing food, rare and medium steaks, medium patties, ham slices, fish steaks, frankfurters |
| 2 | Well-done steaks and patties, lamb chops, split chicken, pork steaks and chops, whole fish |
| 1 | Not used for broiling |

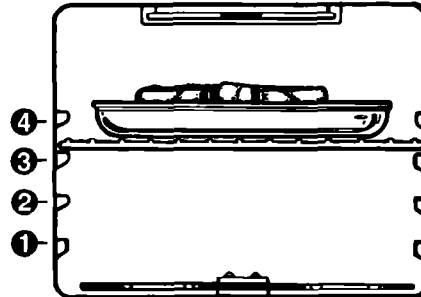

Broiling tips

- **Use** the broiler pan and grid for broiling. They are designed to drain excess liquid and grease away from the cooking surface to help prevent spatter, smoke, or fire.
- **Do not cover** the broiler grid with foil.
- **Place food** about 3" or more from the broil element.
- **To ensure** adequate grease drainage, do not use cookie sheets or similar pans for broiling.
- **After broiling, remove** the broiler pan from the oven when you remove the food. Drippings will bake on the pad if you leave it in the heated oven.

USING YOUR RANGE

Energy saving tips

Although the energy used for cooking is usually a very small percentage of the total energy used in the home, cooking energy can be used efficiently. Here are some tips to help you save energy when using your cooking product:

- **Use** pans with flat bottoms, straight sides, and tight-fitting lids.
- **Match** the pan to the surface unit size.
- **Cook** with a minimum of liquid or fat to help shorten cooking time.
- **Preheat** pans only when recommended and for the shortest time possible.
- **Start** food on higher heat settings, then set surface unit control on low or off to finish cooking. Use retained heat for cooking when possible.
- **Use** the more efficient surface units instead of the oven when possible.
- **Turn on** the surface unit only after placing filled pan on the unit.
- **“Oven peeking”** may cause heat loss, longer cooking times, and unsatisfactory baking results. Rely on your timer to keep track of the cooking time.
- **Bake** cakes, pies, or cookies when the oven is warm. Best time to bake is right after a meal has been cooked in the oven.
- **Preheat** the oven no longer than necessary.
- **Plan** your meals for the most efficient use of the range. When using the oven to cook one food, try to cook the rest of the meal in it also.
- **Do not preheat** when broiling, roasting, or cooking items such as casseroles.

Using the MEALTIMER™ clock

The MEALTIMER clock is designed to turn the oven on and off at times you set, even when you are not around.

Delayed time baking/roasting is ideal for foods which do not require a preheated oven, such as meats and casseroles. **Do not use delayed time cooking for cakes, cookies, etc. – they will not rise properly.**

Before using the MEALTIMER clock, make sure the clock is set to the correct time of day. (See "Setting the clock" on page 11.)

! WARNING

Food Poisoning Hazard

Do not let food sit in oven more than one hour before or after cooking.

Failure to follow the above can result in death, food poisoning, or sickness.

To delay start and stop automatically:

1. **Position** the oven rack(s) properly and **place** the food in the oven.
2. **Push in and turn** the Start Time Knob **clockwise** to the time you want baking/roasting to start.
3. **Push in and turn** the Stop Time Knob **clockwise** to the time you want the oven to shut off.
4. **Set** the Oven Selector to TIMED BAKE.
5. **Set** the Oven Temperature Control Knob to the baking/roasting temperature you want. The oven will now start and stop automatically. The OVEN HEATING Indicator Light will come on when the start time is reached.
6. **After baking/roasting is done or to cancel the setting at any time, turn** both the Oven Selector and Oven Temperature Control Knob to OFF.

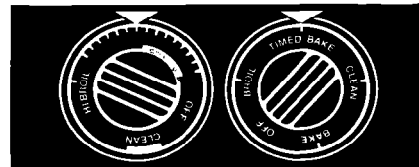
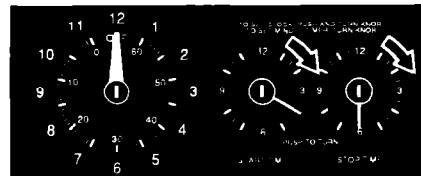

USING YOUR RANGE

To start baking/roasting now and stop automatically:

1. **Position** the oven rack(s) properly and **place** the food in the oven.
2. **Push in and turn** the Stop Time Knob **clockwise** to the time you want the oven to shut off. Make sure the Start Time Knob is not pushed in.
3. **Set** the Oven Selector to TIMED BAKE.
4. **Set** the Oven Temperature Control Knob to the baking/roasting temperature you want.
5. **After baking/roasting is done or to cancel the setting at any time, turn** both the Oven Selector and the Oven Temperature Control Knob to OFF.

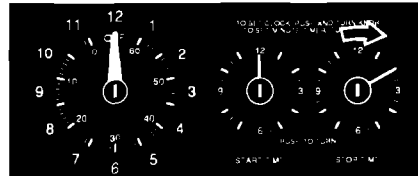

The oven vent

Hot air and moisture escape from the oven through a vent on the backguard below the control panel. The vent is needed for air circulation. **Do not block the vent.** Poor baking/roasting can result.

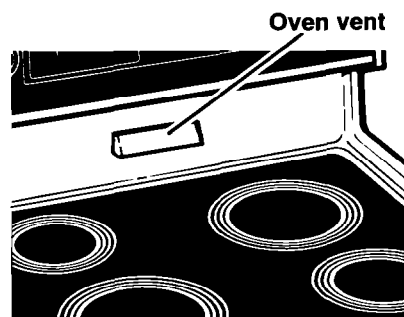

The storage drawer

You can remove the storage drawer to make it easier to clean under the range and to check for installation of the anti-tip floor bracket (if you have one). **Use care when handling the drawer.**

Removing the storage drawer:

1. **Empty** drawer of any pots and pans before removing drawer. **Pull** drawer straight out to the first stop. **Lift** front and **pull out** to the second stop.
2. **Lift** back slightly and **slide** drawer all the way out.

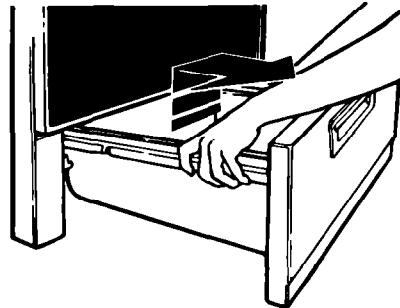

Replacing the storage drawer:

1. **Fit** ends of drawer slide rails into the drawer guides on both sides of opening.
2. **Lift** drawer front and **push in** until metal stops on drawer slide rails clear white stops on drawer guides. **Lift** drawer front again to clear second stop and **slide** drawer closed.

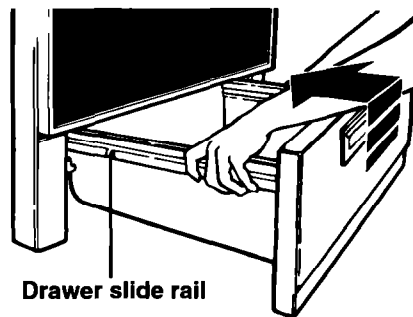

USING YOUR RANGE

The anti-tip bracket

The range will not tip during normal use. However, tipping can occur if you apply too much force or weight to the open door without the anti-tip bracket properly secured.



⚠ WARNING

Tip Over Hazard

- **Connect anti-tip bracket to the range feet.**
- **Reconnect anti-tip bracket, if the range is moved.**
- **Do not push down on the open oven door.**
- **Follow the installation instructions.**
- **Do not let children climb onto the oven door.**
- **Failure to do so can result in death, burns, or other injury.**

To verify the anti-tip bracket is engaged (if you have a floor bracket):

- **Remove** the storage drawer. (See page 19.)
- **Look** to see if the anti-tip bracket is attached to floor with screws.
- **Make sure** one rear leveling leg is positioned under the anti-tip bracket.
- **See** Installation Instructions for further details.

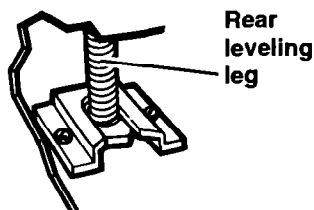

Floor bracket

To verify the anti-tip bracket is engaged (if you have a wall bracket):

- **Look** to see if the anti-tip bracket is attached with screws to the wall behind the control panel.
- **Make sure** the cable on the back of the range is secured by the two hooks on the bracket.
- **Cable** must be unhooked from wall bracket to move range for cleaning or service. Reconnect cable before using range.
- **See** Installation Instructions for further details.

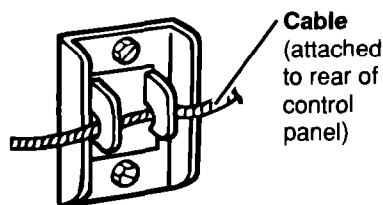

Wall bracket

Optional door panel pac

If you would like to change the color of your oven door glass to white or almond, you can order one of these kits from your Roper Dealer. The kits include easy installation instructions.

- **White** (Kit No. 814071)
- **Almond** (Kit No. 814072)

Using the Self-Cleaning Cycle

| In This Section | | Page | Page |
|---------------------------|----|----------------------------|------|
| How the cycle works | 21 | Setting the controls | 22 |
| Before you start | 22 | Special tips | 23 |

The Self-Cleaning cycle saves you from the toil and mess that often come with hand-cleaning the oven interior. Like the other functions of your range, you operate the Self-Cleaning cycle with the easy-to-use controls. Please review the instructions in this section to keep your oven spotless.



⚠ WARNING

Burn Hazard

Do not touch the oven during the Self-Cleaning cycle.

Keep children away from oven during Self-Cleaning cycle.

Do not use commercial oven cleaners in your oven.

Failure to follow the above can result in burns, or illness from inhaling dangerous fumes.

How the cycle works

The Self-Cleaning cycle uses very high heat to burn away soil and grease. During the cycle, the oven gets much hotter than it does for normal baking or broiling. This high heat breaks up the soil or grease and burns it away.

You can adjust the cycle time to the amount of soil in your oven. You can set the cycle time anywhere between two and four hours. (See "Setting the controls" on page 22.)

The graph at the right is representative of a normal, 3-hour Self-Cleaning cycle. Note that the heating stops when the 3-hour setting is up, but it takes longer for the oven to cool enough to unlock.

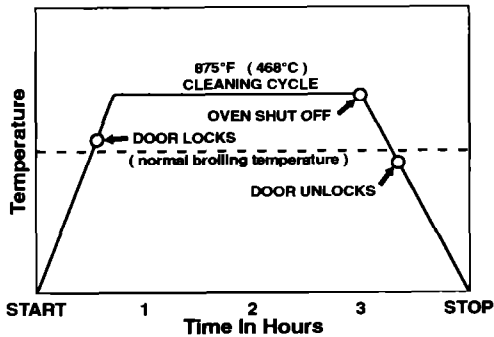

USING THE SELF-CLEANING CYCLE

Before you start

Before you start the Self-Cleaning cycle, make sure you:

- **Hand-clean the areas shown.** They do not get hot enough during the cleaning cycle for soil to burn away. Use hot water and detergent or a soapy steel-wool pad for cleaning.

NOTE: DO NOT clean, move, or bend the seal. Poor cleaning, baking, and roasting may result.

- **Remove the broiler pan and grid and any pots and pans** being stored in the oven.

NOTE: You can clean the broiler pan (without grid) in the oven if you have first removed most of the soil by hand-cleaning or in a dishwasher. If most of the soil is not removed, too much smoking will occur. The chrome broiler pan and grid will discolor if cleaned in the Self-Cleaning cycle.

- **Wipe out any loose soil or grease.** This will help reduce smoke during the Self-Cleaning cycle.
- **Remove the oven racks from the oven if you want them to remain shiny.** You can clean the oven racks in the Self-Cleaning cycle, but they will become harder to slide. (See page 27.) If you clean racks in the Self-Cleaning cycle, place them on the 2nd and 4th rack guides. (Guides are counted from bottom to top.)
- **Heat and odors** are normal during the Self-Cleaning cycle.

DO NOT hand-clean seal

Hand-clean frame

Hand-clean door around edge

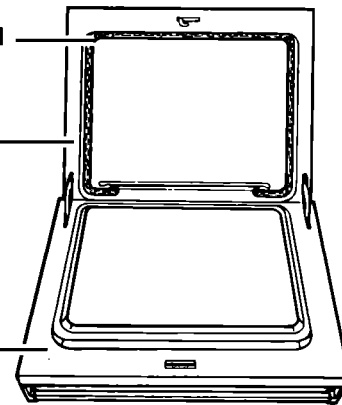

Keep the kitchen well ventilated by opening a window or by turning on a vent hood or other kitchen vent during the cycle.

NOTES:

- **Do not force** the Lock Lever. You could bend or break it. The lever is designed to stay locked until the oven is cool enough to safely open. Wait until it moves freely.
- **Do not block** the vent during the Self-Cleaning cycle. Air must move freely for best cleaning results.
- **Do not leave** any foil in the oven during the Self-Cleaning cycle. Foil could burn or melt and damage the oven surface.
- **Do not leave** plastic utensils near the vent. They may melt.
- **The oven light** will not work during the Self-Cleaning cycle.

Setting the controls

1. **Move** the Lock Lever to the right – the Clean position.

When the oven temperature goes above normal baking/roasting temperatures, the door cannot be opened and the Lock Lever must not be moved.

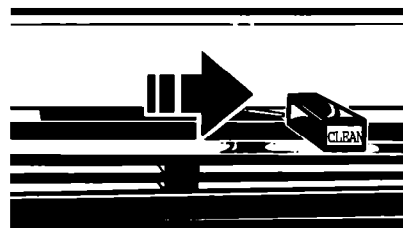

2. **Set** the Oven Selector and Oven Temperature Control Knob to CLEAN.

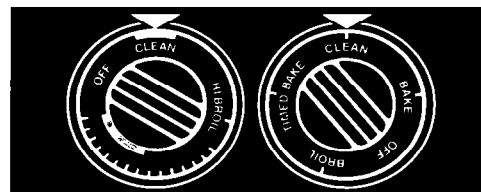

USING THE SELF-CLEANING CYCLE

3. **Make sure** the clock and Start and Stop Times all have the correct time of day.

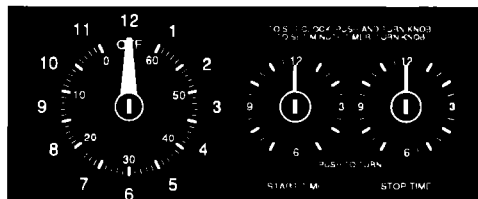

4. **Push in and turn** the Stop Time Knob **clockwise** two or three hours. The OVEN HEATING Indicator Light will come on.

- **Use** two hours for light soil.
- **Use** three hours or more for moderate to heavy soil.

NOTE: Make sure the Start Time Knob is not pushed in.

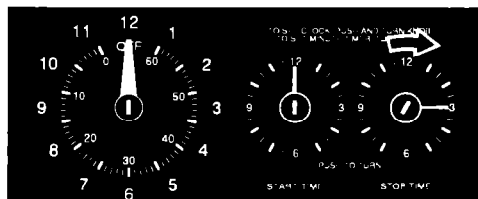

5. **After the Self-Cleaning cycle is completed and the oven has cooled sufficiently**, the Lock Lever can be moved back to the left. **DO NOT FORCE IT.** Wait until it moves easily. Turn the Oven Selector and Oven Temperature Control Knob to OFF.

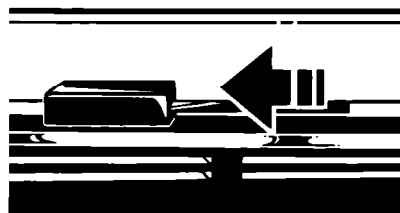

6. **After the oven is cool, wipe off** any residue or ash with a damp cloth. **If needed, touch up** spots with a soapy steel-wool pad.

To stop the Self-Cleaning cycle at any time:

1. **Push in and turn** the Stop Time Knob **clockwise** until it points to the correct time of day.
2. **Turn** the Oven Selector and Oven Temperature Control Knob to OFF. When the oven has cooled sufficiently, **move** the Lock Lever back to the left. **DO NOT FORCE IT.** Wait until it moves easily.

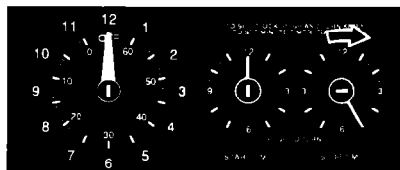

Special tips

- **Keep** the kitchen well ventilated during the Self-Cleaning cycle to help get rid of heat, odors, and smoke.
- **After the oven is cool**, wipe up any residue or ash with a damp cloth or sponge. If any spots remain, clean with a mild abrasive cleanser or cleaning sponge.
- **Clean** the oven before it gets heavily soiled. Cleaning a very soiled oven takes longer and results in more smoke than usual.
- **If the Self-Cleaning cycle** does not get the oven as clean as you expected, the cycle may not have been set long enough or you may not have prepared the oven properly. Set the Self-Cleaning cycle longer the next time and hand-clean areas noted on page 21.

Caring for Your Range

In This Section

| | Page | Page | |
|----------------------------------|------|----------------------|----|
| Cleaning the cooktop | 24 | The oven light | 28 |
| Cleaning other range parts | 27 | | |

Your range is designed for easy care. You can do most cleaning with items found around your home. Cleaning your range whenever spills or soiling occurs will help to keep it looking and operating like new.

Cleaning the cooktop

This cooktop is designed for easy care. However, ceramic cooktops need to be maintained differently than standard electric open-coil elements. Foods spilled directly on the cooktop will not burn off as on open-coil elements. Because of this, the surface should be dust-free and soil-free before heating.

Your cooktop has been prepolished at the factory for improved protection and cleanability. The Cooktop Polishing Creme (included with your range), paper towels or a sponge, and a single edge razor blade in a holder is all you need to clean your cooktop. For proper cleaning methods, please review "Cleaning tips" on pages 25 and 26. Follow them after each use to ensure top performance and to preserve that uniquely elegant look.

NOTE: Let cooktop cool before cleaning.



CARING FOR YOUR RANGE

To avoid damaging the cooktop, follow these instructions:

- **Sugar spills and soils** (such as jellies and candy syrups) can cause pitting on the cooktop if not removed **while the ceramic surface is still warm**. Remove as soon as possible after the spill occurs.
- **Do not use** the cooktop as a cutting board.
- **Do not allow** anything that may melt (such as plastic or aluminum foil) to come in contact with the surface while it is hot.
- **Do not use** the ceramic cooktop to cook popcorn that comes in prepackaged aluminum containers. The container could leave aluminum marks on the cooktop that cannot be removed completely.
- **Do not use** steel wool, plastic cleaning pads, abrasive powdered cleansers, chlorine bleach, rust remover, ammonia, or glass cleaning products with ammonia. These could damage the cooktop surface.
- **Dropping** heavy or hard objects on the cooktop could crack it. Be careful with heavy skillets. Do not store jars or cans above the cooktop.

Cleaning tips

What to use:

- **Cooktop Polishing Creme (included with your range) with paper towel or clean, damp sponge** – This creme has been developed especially for cleaning and protecting your cooktop. When using, follow instructions on container.
- **Razor scraper in a holder** – Use to remove cooked-on soils from your ceramic cooktop. To avoid scratches, keep the razor blade as flat against the cooktop as possible. **Store razor blades out of reach of children.**

Steps to follow:

1. **Most spills** can be wiped off easily using a paper towel or clean, damp sponge as soon as Hot Surface Indicator Light(s) go off.
2. **For stubborn spills**, rub Cooktop Polishing Creme into cooked-on soil using a paper towel. If some soil remains, leave some creme on the spot(s) and follow Step 3.
3. **Carefully scrape** spots with the razor scraper.
4. **Finish** by polishing entire cooktop with Cooktop Polishing Creme and a paper towel.

continued on next page

CARING FOR YOUR RANGE

Additional tips:

- **Remove dark streaks, specks, and discoloration** with Cooktop Polishing Creme.
- **Remove metal marks** (from copper or aluminum pans) with Cooktop Polishing Creme before heating the cooktop again. If heated before cleaning, metal marks may not come off.
- **Tiny scratches or abrasions do not affect cooking.** In time, these will become less visible as a result of cleaning. To prevent scratches and abrasions, use Cooktop Polishing Creme regularly.
- **Nonabrasive cleanser with damp paper towel or sponge** can be used as an alternative method for removing cooked-on soils. **Always rinse and dry your cooktop** thoroughly after using cleanser to prevent streaking or staining.

To obtain order information for Cooktop Polishing Creme (Part No. 3184477) or razor scraper (Part No. 3183488), write to:

Whirlpool Corporation
Attention: Customer Service Dept.
1900 Whirlpool Drive
LaPorte, IN 46350

OR

Call **1-800-253-1301** to order. You must have a major credit card to order by phone.

CARING FOR YOUR RANGE

Cleaning other range parts

Use the following table to help you clean all other parts of your range.

| PART | WHAT TO USE | HOW TO CLEAN |
|--|--|---|
| Control knobs | Sponge and warm, soapy water | <ul style="list-style-type: none"> • Turn knobs to OFF and pull straight away from control panel. • Wash, rinse, and dry thoroughly. Do not soak. Do not use steel wool or abrasive cleansers. They may damage the finish of the knobs. • Replace knobs. Make sure all knobs point to OFF. |
| Control panel | Sponge and warm, soapy water OR Paper towel and spray glass cleaner | <ul style="list-style-type: none"> • Wash, wipe with clean water, and dry thoroughly. Do not use steel wool or abrasive cleansers. They may damage the finish. • Do not spray cleaner directly on panel. Apply cleaner to paper towel. |
| Exterior surfaces (other than cooktop and control panel) | Sponge and warm, soapy water | <ul style="list-style-type: none"> • Wash, wipe with clean water, and dry thoroughly. Use nonabrasive, plastic scrubbing pad on heavily soiled areas. • Do not use abrasive or harsh cleansers. They may damage the finish. |
| Broiler pan and grid (clean after each use) | Steel-wool pad and warm, soapy water | <ul style="list-style-type: none"> • Wash, rinse, and dry thoroughly. Do not clean in Self-Cleaning cycle. (See note on page 22.) |
| Oven racks | Steel-wool pad and warm, soapy water OR The Self-Cleaning cycle | <ul style="list-style-type: none"> • Wash, rinse, and dry thoroughly. OR • Leave in oven during Self-Cleaning cycle. <p>NOTE: Racks will permanently discolor and become harder to slide if left in oven during Self-Cleaning cycle. Apply a small amount of vegetable oil to the side rungs to aid sliding.</p> |
| Oven door glass | Paper towel and spray glass cleaner OR Warm, soapy water and a nonabrasive, plastic scrubbing pad | <ul style="list-style-type: none"> • Make sure oven is cool. • Follow directions provided with the cleaner. • Wash, wipe with clean water, and dry thoroughly. |
| Oven cavity | Self-Cleaning cycle | <ul style="list-style-type: none"> • See "Using the Self-Cleaning Cycle" on pages 21-23. |

The oven light

To turn on the oven light, press the Oven Light Switch on the control panel.

⚠ WARNING



Electrical Shock Hazard

Unplug oven before changing light bulb.

Replace light bulb cover before using the oven.

Failure to do so can result in death or electrical shock.

To replace the oven light:

1. **Unplug** appliance or **disconnect** at the main power supply.
2. **Remove** the glass bulb cover in the back of the oven by screwing it out counter-clockwise.
3. **Remove** the light bulb from its socket. **Replace** the bulb with a 40-watt appliance bulb.

4. **Replace** the bulb cover by screwing it in clockwise. **Plug in** appliance or **reconnect** at the main power supply.

NOTE: The oven light will not work during the Self-Cleaning cycle.

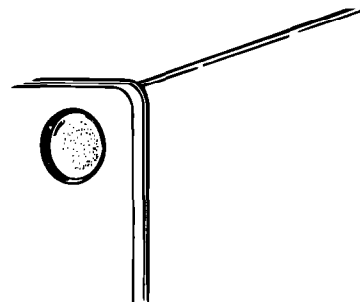
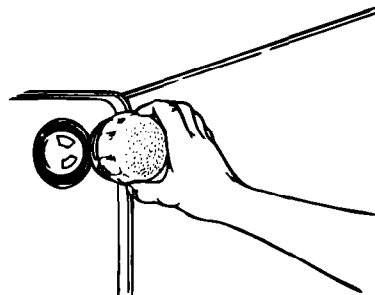

If You Need Assistance or Service

This section is designed to help you save the cost of a service call. Part 1 of this section outlines possible problems, their causes, and actions you can take to solve each problem. Parts 2 and 3 tell you what to do if you still need assistance or service. When calling our toll-free telephone number for help or calling for service, please provide a detailed description of the problem, your appliance's complete model and serial numbers, and the purchase date. (See page 2.) This information will help us respond properly to your request.

1. Before calling for assistance ...

Performance problems often result from little things you can find and fix without tools of any kind. Please check the chart below for problems you can fix. It could save you the cost of a service call.

| PROBLEM | POSSIBLE CAUSE | SOLUTION |
|---------------------------------------|---|---|
| Nothing operates | The power supply cord is not plugged into a live circuit with the proper voltage. A household fuse has blown or a circuit breaker has tripped. | Plug power supply cord into a live circuit with proper voltage. (See Installation Instructions.) Replace household fuse or reset circuit breaker. |
| The oven will not operate | The Oven Selector is not turned to BAKE or BROIL. A delayed start time has been set. The Oven Temperature Control Knob is not turned to a temperature setting. The MEALTIMER™ clock is not set correctly. The Stop or Start Time Knobs for the MEAL-TIMER clock are not set at the correct time of day. | Turn the Oven Selector to the desired setting. Wait for the start time to be reached or cancel and reset the controls. Turn the Oven Temperature Control Knob to the desired setting. Set the MEALTIMER clock correctly. (See "Using the MEALTIMER™ clock" on page 17.) If a delay start or stop is not desired, the Stop and Start Time Knobs must be turned to the correct time of day. Turn knobs till they pop out. |
| Surface units will not operate | A household fuse has blown or a circuit breaker has tripped. The control knob(s) will not turn. | Replace household fuse or reset circuit breaker. Turn knob(s) again, pushing in as you turn. |

continued on next page

IF YOU NEED ASSISTANCE OR SERVICE

| PROBLEM | POSSIBLE CAUSE | SOLUTION |
|--|--|--|
| Control knob(s) will not turn | You are not pushing in before trying to turn. | Push control knob(s) in before turning to a setting. |
| Self-Cleaning cycle will not operate | <p>The Oven Selector and Oven Temperature Control Knob are not set to CLEAN.</p> <p>The range clock does not show the correct time of day.</p> <p>The Lock Lever is not in the CLEAN position – all the way to the right.</p> <p>The Start Time Knob does not show the correct time of day or the knob is not all the way out.</p> <p>The Stop Time Knob is not set ahead to the time you want the Self-Cleaning cycle to stop.</p> | <p>Set both the Oven Selector and Oven Temperature Control Knob to CLEAN.</p> <p>Reset clock to show the correct time of day. (See page 11.)</p> <p>Move the Lock Lever all the way to the right.</p> <p>Reset the Start Time Knob to show the correct time of day. Pull knob out all the way.</p> <p>See Step 3 in “Setting the controls” on page 23 for proper setting instructions.</p> |
| Cooking results are not what you expected | <p>The range is not level.</p> <p>The oven temperature seems too low or too high.</p> <p>The oven was not preheated as the recipe calls for.</p> <p>The recipe you are using may need to be altered to improve the taste or appearance of the food.</p> <p>The pan used is not the type or size recommended in the recipe.</p> <p>There is not proper air circulation around pan when baking.</p> <p>The cooking utensils are not the proper shape or do not fit the surface units being used.</p> | <p>Level range. (See Installation Instructions.)</p> <p>Adjust the oven temperature control. (See “Adjusting the oven temperature control” on page 13.)</p> <p>Preheat oven if called for in recipe.</p> <p>Alter recipe as needed.</p> <p>Refer to a reliable cookbook for recommended pan type and size.</p> <p>Allow 1½ to 2 inches (4-5 cm) on all sides of the pans for air circulation. There must be a minimum space of 1 inch (3 cm).</p> <p>Use cooking utensils with smooth, flat bottoms that fit the surface units being used.</p> |

IF YOU NEED ASSISTANCE OR SERVICE

2. If you need assistance ...

Call our toll-free telephone number. Dial toll-free from anywhere in the U.S.A.:

**1-800-44-ROPER
(1-800-447-6737)**

and talk with one of our trained consultants. The consultant can instruct you in how to obtain satisfactory operation from your appliance or, if service is necessary, recommend a qualified service company in your area.

For further information, write to:

Mr. William Clark
Consumer Assistance Representative
Roper Brand Appliances
2000 North M-63
Benton Harbor, MI 49022-2692

Please include a daytime phone number in your correspondence.

3. If you need service ...

Contact the dealer from whom you purchased the appliance or the authorized servicer in your area. For help finding an authorized servicer in your area, call our toll-free telephone number in Step 2.

4. If you need FSP® replacement parts ...

FSP is a registered trademark of Whirlpool Corporation for quality parts. Look for this symbol of quality whenever you need a replacement part for your ROPER® appliance. FSP replacement parts will fit right and work right, because they are made to the same exacting specifications used to build every new ROPER appliance.

To locate FSP replacement parts in your area, refer to Step 3 above or call our toll-free telephone number in Step 2.

5. If you are not satisfied with how the problem was solved ...

- Contact the Major Appliance Consumer Action Program (MACAP). MACAP is a group of independent consumer experts that voices consumer views at the highest levels of the major appliance industry.
- Contact MACAP only when the dealer, authorized servicer, and Roper Brand Appliance warrantor have failed to resolve your problem.

Major Appliance Consumer Action Program
20 North Wacker Drive
Chicago, IL 60606

- MACAP will in turn inform us of your action.

ROPER®

Black Ceramic Glass Top Freestanding Range Warranty

| LENGTH OF WARRANTY | WE WILL PAY FOR |
|---|---|
| FULL ONE-YEAR WARRANTY From Date of Purchase | FSP® replacement parts and repair labor to correct defects in materials or workmanship. Service must be provided by an authorized Roper service company. |
| FULL THREE-YEAR WARRANTY From Date of Purchase | FSP replacement parts and repair labor for ceramic cooktop to the original purchaser of this product. We warrant that: <ul style="list-style-type: none"> - The ceramic cooktop will not discolor - The ceramic cooktop pattern will not wear off - The rubber seal between the ceramic cooktop and porcelain edge will not crack - The ceramic cooktop will not crack due to thermal shock - The surface units will not burn out |
| WE WILL NOT PAY FOR | |
| <p>A. Service calls to:</p> <ol style="list-style-type: none"> 1. Correct the installation of your range. 2. Instruct you how to use your range. 3. Replace house fuses or correct house wiring. 4. Replace owner-accessible light bulbs. <p>B. Repairs when your range is used in other than normal, single-family household use.</p> <p>C. Pickup and delivery. Your range is designed to be repaired in the home.</p> <p>D. Damage to your range caused by accident, misuse, fire, flood, acts of God, or use of products not approved by us.</p> <p>E. Repairs to ceramic cooktop if it has not been cared for as recommended in this Use and Care Guide.</p> <p>F. Repairs to parts or systems caused by unauthorized modifications made to the appliance.</p> | |

1/95

This Roper appliance is warranted by Whirlpool Corporation. Under no circumstances shall it be liable under this warranty for incidental or consequential damages. Some states do not allow the exclusion or limitation of incidental or consequential damages, so this exclusion or limitation may not apply to you.

This warranty gives you specific legal rights, and you may also have other rights which vary from state to state.

Outside the United States, a different warranty may apply. For details, please contact your authorized Roper distributor or military exchange.

If you need service, first see the "Troubleshooting" section of this book. After checking "Troubleshooting," additional help can be found by checking the "Requesting Assistance or Service" section, or by calling our toll-free telephone number, **1-800-44-ROPER (1-800-447-6737)**, from anywhere in the U.S.A.