

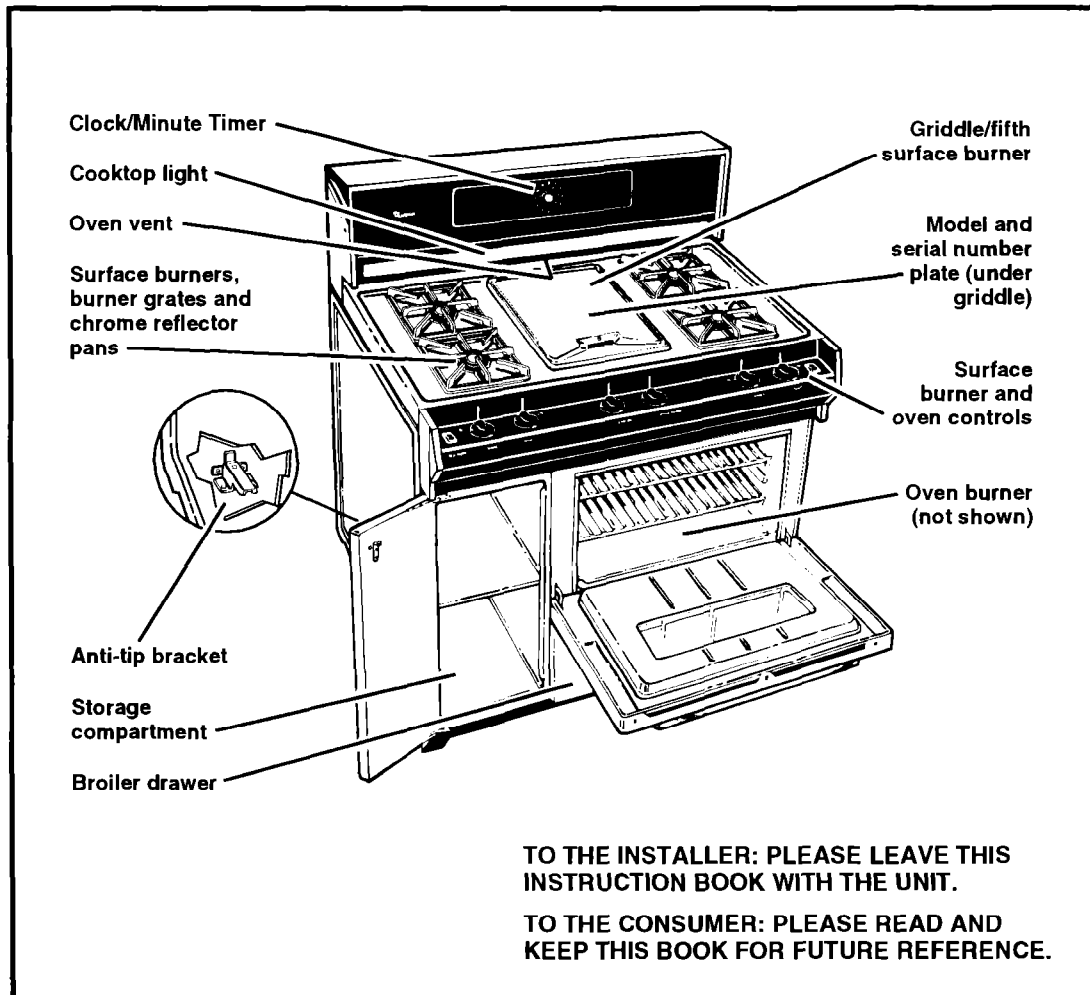

HOW TO MAKE A HOME RUN.™

Use & Care Guide



STANDARD-CLEANING GAS RANGE

SF5140EY

7/95

PART NO. 07682301/4362951 Rev. A

Contents

	Page
Important Safety Instructions	3
Using Your Range	6
Using the surface burners	6
Setting the clock	7
Using the Minute Timer	7
Using the oven control	8
Baking/roasting	8
Adjusting the oven temperature control	9
Broiling	10
Using the griddle or fifth surface burner	11
Using the fifth surface burner	12
The oven vent	12
Caring For Your Range	13
Control panel and knobs	13
Surface burner grates, reflector pans and griddle	14
Surface burners	15
Lift-up cooktop	15
Removable oven door	16
Removing the broiler carriage	17
Using the standard-cleaning oven	18
Cleaning tips	18
Using and replacing the light bulbs	20
The cooktop light	20
The oven light	21
If You Need Service Or Assistance	22
Whirlpool Range Warranty	24

©1995 Whirlpool Corporation

Thank you for buying a WHIRLPOOL appliance. Please complete and mail the Owner Registration Card provided with this product. Then complete the form below. Have this information ready if you need service or call with a question.

- Copy model and serial numbers from plate (located under griddle) and purchase date from sales slip.
- Keep this book and sales slip together in a handy place.

Model Number

Serial Number

Purchase Date

Service Company Phone Number

You are responsible for:

- Installing and leveling the range on a floor strong enough to support its weight, and where it is protected from the elements. (See the Installation Instructions.)
- Making sure the range is not used by anyone unable to operate it properly.
- Properly maintaining the range.
- Using the range only for jobs expected of a home range.
- Making sure the range is secured by a properly installed anti-tip bracket.

Important Safety Instructions

READ AND SAVE THESE INSTRUCTIONS

Gas ranges have been thoroughly tested for safe and efficient operation. However, as with any appliance, there are specific installation and safety precautions which must be followed to ensure safe and satisfactory operation.

⚠ WARNING

To reduce the risk of fire, electrical shock, injury to persons, or damage when using the range, follow basic precautions, including the following:

WARNING: If the information in this manual is not followed exactly, a fire or explosion may result causing death, personal injury, or property damage.

DO NOT STORE OR USE GASOLINE OR OTHER FLAMMABLE VAPORS AND LIQUIDS IN THE VICINITY OF THIS OR ANY OTHER APPLIANCE.

WHAT TO DO IF YOU SMELL GAS:

- **DO NOT TRY TO LIGHT ANY APPLIANCE.**
- **DO NOT TOUCH ANY ELECTRICAL SWITCH; DO NOT USE ANY PHONE IN YOUR BUILDING.**
- **IMMEDIATELY CALL YOUR GAS SUPPLIER FROM A NEIGHBOR'S PHONE. FOLLOW THE GAS SUPPLIER'S INSTRUCTIONS.**
- **IF YOU CANNOT REACH YOUR GAS SUPPLIER, CALL THE FIRE DEPARTMENT.**

INSTALLATION AND SERVICE MUST BE PERFORMED BY A QUALIFIED INSTALLER, SERVICE AGENCY OR THE GAS SUPPLIER.

Important Safety Instructions Continued

- Install or locate the range only in accordance with the provided Installation Instructions. The range must be installed by a qualified installer. The range must be properly connected to the proper gas supply and checked for leaks. The range must also be properly connected to electrical supply and grounded.
- Gas fuels and their use in appliances can cause minor exposures to benzene, formaldehyde, carbon monoxide and soot, primarily from incomplete combustion. Significant exposure to these substances can cause cancer or reproductive harm. Properly adjusted burners with a blue, rather than a yellow, flame will minimize incomplete combustion. Venting with a hood or an open window will further minimize exposure.

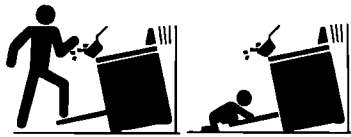

- **WARNING:** To reduce the risk of tipping the appliance, the appliance must be secured by a properly installed anti-tip bracket. To check if the bracket is installed properly, shine a flashlight under range toward left rear corner and verify that the anti-tip bracket is engaged. See Installation Instructions for further details.
- Do not operate the range if it is damaged or not working properly.
- Do not use the range for warming or heating the room. Persons could be burned or injured, or a fire could start.
- Do not attempt to light the oven burner during a power failure. Personal injury could result. Reset oven controls to the off position in the event of a power failure.
- Use the range only for its intended use as described in this manual.
- Do not wear loose or hanging garments when using the range. They could ignite if they touch a hot surface burner and you could be burned.
- Do not touch surface burners, areas near surface burners, or interior surfaces of oven. Areas near surface burners and interior surfaces of an oven become hot enough to cause burns. During and after use, do not touch, or let clothing or other flammable materials contact surface burners, areas near surface burners, or interior surfaces of oven until they have had sufficient time to cool. Other surfaces of the range, such as the oven vent opening, the surface near the vent opening, the cooktop, and the oven door and window, could also become hot enough to cause burns.
- Make sure the utensils you use are large enough to contain food and avoid boil-overs and spillovers. Heavy splattering or spillovers left on a range can ignite and burn you. Pan size is especially important in deep fat frying.
- Turn pan handles inward, but not over other surface burners. This will help reduce the chance of burns, igniting of flammable materials, and spills due to bumping of the pan.
- Use only dry pot holders. Moist or damp pot holders on surface burners may result in burns from steam. Do not let pot holder touch an open flame. Do not use a towel or bulky cloth for a pot holder. It could catch on fire.
- Check to be sure glass cooking utensils are safe for use on the range. Only certain types of glass, glass-ceramic, ceramic, earthenware or other glazed utensils are suitable for ranges without breaking due to the sudden change in temperature.

- Do not use decorative covers or trivets over the surface burners.
- Do not heat unopened containers. They could explode. The hot contents could cause burns and container particles could cause injury.
- Grease is flammable. Do not allow grease to collect around cooktop or in vents. Wipe spillovers immediately.
- Do not use water on grease fires. Never pick up a flaming pan. Smother flaming pan on range by covering with a well-fitted lid, cookie sheet or flat tray. Flaming grease outside of pan can be extinguished with baking soda or, if available, a multipurpose dry chemical or foam-type extinguisher.
- Never leave surface burners unattended at high heat settings. A boilover could result and cause smoking and greasy spillovers that may ignite.
- Use care when opening oven door. Let hot air or steam escape before removing or replacing food.
- Always position oven rack(s) in desired location while oven is cool.
- Do not store flammable materials on or near the range. The fumes can create an explosion and/or fire hazard.
- Do not use the oven for storage.
- Do not use aluminum foil to line area around burners, oven bottom, or any other part of the range. Use aluminum foil only as recommended in this manual.
- Do not store things children might want above the range. Children could be burned or injured while climbing on it.
- Do not leave children alone or unattended in area where the range is in use. They should never be allowed to sit or stand on any part of the range. They could be burned or injured.
- Never use a match or other flame to look for a gas leak. Explosion and injury could result.
- Know where your main gas shut off valve is located.
- Keep range vents unobstructed.
- Do not clean door heat seal. It is essential for a good seal. Care should be taken not to rub, damage, or move the seal. Clean only parts recommended in this Use and Care Guide.
- Do not repair or replace any part of the range unless specifically recommended in this manual. All other servicing should be referred to a qualified technician.
- Any additions, changes, or conversions required in order for this appliance to satisfactorily meet the application needs must be made by a Whirlpool service company or Qualified Agency.
- Disconnect the electrical supply and the gas supply at the shutoff valve near the range before servicing the range.

– READ AND SAVE THESE INSTRUCTIONS –

Using Your Range

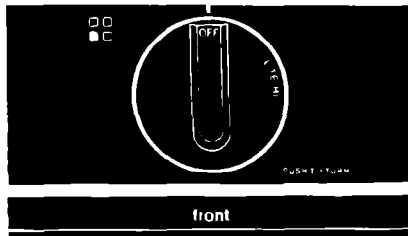
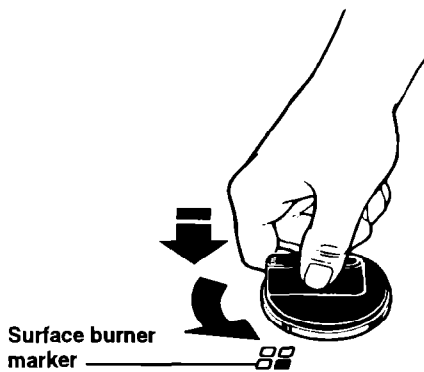

Using the surface burners

Control knobs must be pushed in and turned to the LITE position. The clicking sound is the ignition sparking.

To stop the clicking sound after the burner lights, turn the control knob back to a desired setting. The control knob can be set anywhere between HI and OFF.

Surface burner markers

The solid dot in the surface burner marker shows which surface burner is turned on by that knob.

Until you get used to the settings, use the following as a guide. For best results, start cooking at the high settings; then turn the control knob down to continue cooking.

Use LITE to light the burner. After the burner lights, turn control back to a desired setting to stop the clicking of the ignition.

Use HI to start foods cooking; to bring liquids to a boil.

Use a medium setting to continue cooking or to fry chicken or pancakes; for gravy, pudding and icing; to cook large amounts of vegetables.

Use a low setting to keep food warm until ready to serve.

NOTE: Do not cook with the control in the LITE position.

In case of a prolonged power failure:

Surface burners can be manually lighted. Hold a lighted match near a burner and turn the control to the LITE position. After the burner lights, turn the control to the desired setting.

⚠ WARNING

Fire Hazard

Burner flame should not extend beyond the edge of the cooking utensil.

Be sure all control knobs are turned to off when you are not cooking.

Failure to follow these precautions could result in fire or burns.

NOTE: Do not leave an empty utensil, or one which has boiled dry, on a hot surface burner. The utensil could overheat and damage the utensil or cooking product.

Setting the clock

Push in and turn the Minute Timer Knob to set the clock.

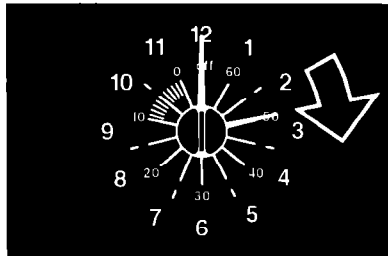

1. Push in Minute Timer Knob and turn clockwise until clock shows the correct time of day.

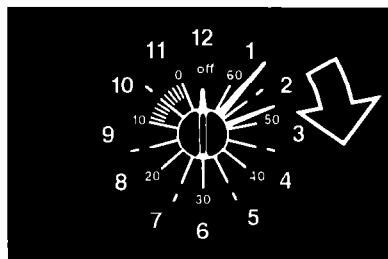

2. Let the Minute Timer Knob pop out. Turn clockwise until Minute Timer hand points to OFF. The clock setting will change if you push in the knob when turning.

Using the Minute Timer

The Minute Timer does not start or stop the oven. It works like a kitchen timer. Set it in minutes up to an hour. You will hear a buzzer when the set time is up.

NOTE: Do not push in the knob when setting the Minute Timer or when stopping the buzzer. Pushing in and turning the Minute Timer Knob changes the clock setting.

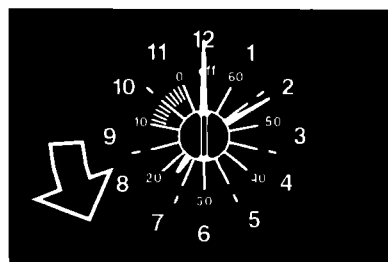

1. Without pushing it in, turn the Minute Timer Knob counterclockwise until the timer hand passes the setting you want.

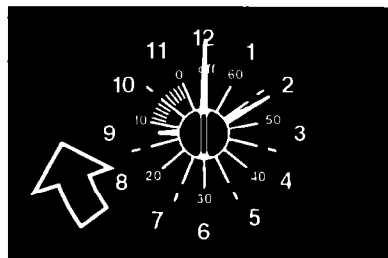

2. Without pushing it in, turn the knob back to the setting you want. When the time is up, a buzzer will sound. To stop the buzzer, turn the Minute Timer hand to OFF.

Using Your Range Continued

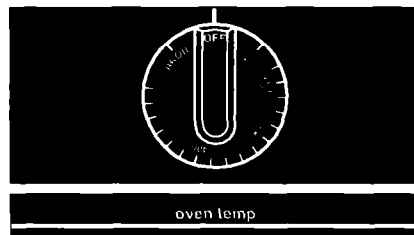
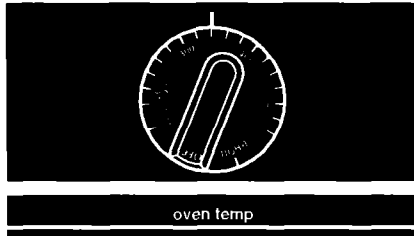

Using the oven control

Baking/roasting

1. Position the rack(s) properly **before** turning on the oven. **To change rack position**, pull rack out to stop, raise front edge and lift out. When using one rack, the rack should be placed so the top of the food will be centered in the oven. Always leave at least 1½ to 2 inches (4-5 cm) between the sides of the pan and the oven walls and other pans.
2. Push in and turn the Oven Temperature Control Knob to the baking/roasting temperature you want. The oven burner will automatically light in 50-60 seconds.
3. When baking, preheat the oven for 10 minutes. Put food in the oven.

NOTES:

- Do not preheat when roasting or cooking items such as casseroles.
 - Do not place food directly on the oven bottom.
4. During baking/roasting, the oven burner will turn on and off to maintain the temperature setting.
 5. When baking/roasting is done, turn the Oven Temperature Control Knob to OFF.

Adjusting the oven temperature control

Although your new oven is properly adjusted to provide accurate temperatures, it may cook faster or slower than your old oven.

If, after using the oven for a period of time, you are not satisfied with the baking/roasting results, you can change the temperature calibration by following these steps:

1. Turn the Oven Temperature Control Knob to the off position. Pull knob straight off and flip it over so the back matches the illustration in Step 2.

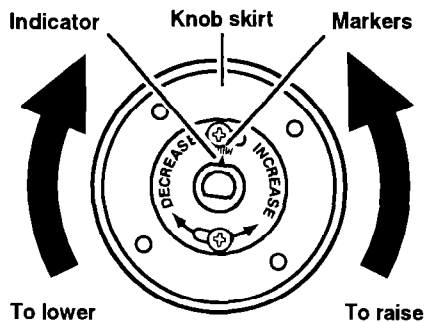
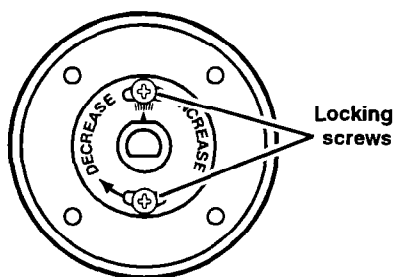

2. Loosen the locking screws. **Note the position of the indicator.**

3. **To lower the temperature**, hold knob handle firmly and turn knob skirt clockwise to move the indicator one marker line to the left. Each line equals about 10°F (5°C).

4. **To raise the temperature**, hold knob handle firmly and turn knob skirt counterclockwise to move the indicator one marker line to the right. Each line equals about 10°F (5°C).

Tighten the locking screws and replace the control knob.

Using Your Range Continued

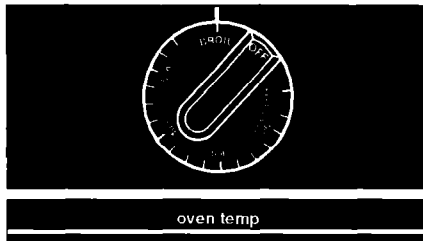
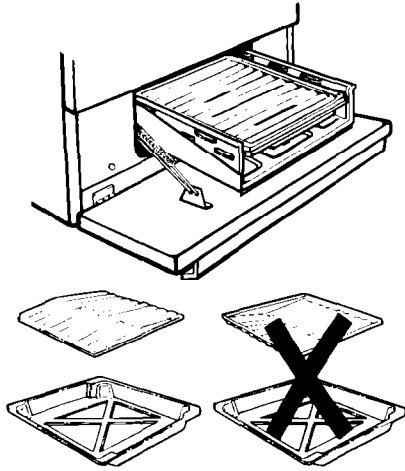

Broiling

The broiler drawer is located below the oven door. **Always broil with the oven door closed.**

1. Pull the broiler drawer open. Broiler door will tilt down when opened.

NOTE: Do not step on or apply excess weight to broiler door when open. Doing so can damage the door.

2. Place broiler pan and grid so grease can drain down sides into lower part of broiler pan. See picture.
3. Before the broiler is turned on, place food on broiler pan and position the broiler pan at one of the three levels. Refer to a reliable cookbook for broiling chart.
4. Push in and turn the Oven Temperature Control Knob to BROIL. The broiler will automatically light in 50-60 seconds.
5. When broiling is done, turn the Oven Temperature Control Knob to OFF.

NOTES:

- Do not preheat the broiler before using.
- Completely close the broiler drawer during broiling.

Using the griddle or fifth surface burner

⚠ WARNING

Fire Hazard

Be sure the griddle/fifth burner control is off and the griddle is cool and covered when not in use.

Failure to follow the above could result in fire or burns.

NOTES:

- When cleaning griddle, never use a metal scouring pad or abrasive cleanser on the griddle. These will damage the nonstick surface.
- Do not use cookware on the griddle. Use only plastic or nylon kitchen utensils on the griddle. Metal can damage the nonstick cooking surface.

Before using the griddle for the first time:

1. The cooking surface should be washed with warm, soapy water, rinsed and dried.
2. After cleaning, lightly wipe the cooking surface with cooking oil to prevent food from sticking. You don't have to season (grease) the griddle every time you use it. Be sure to use only cooking oil (not shortening or butter) to season the griddle.
3. Preheat on HI, then turn control to a lower setting to cook.
4. Place food directly on cooking surface.
5. Turn off the griddle burner when cooking is finished. Leaving burner ON will damage the griddle.

Griddle chart

Preheat on HI, then turn to a lower setting to cook.

FOOD	PREHEAT TIME	COOK SETTING	APPROXIMATE COOKING TIME	
			SIDE 1	SIDE 2
Bacon	No preheat	Med	3 Min	3 Min
Pancakes	5 Min	Med	1½ Min	1 Min
Pork Sausage Patty	No preheat	Med	4 Min	3½ Min
Eggs	No preheat	Med	1½ Min	1 Min
Grilled Sandwiches	5 Min	Med	3 Min	3 Min
French Toast	5 Min	Med	3 Min	3 Min

Griddling times are approximate and may need to be adjusted to individual tastes.

Using Your Range Continued

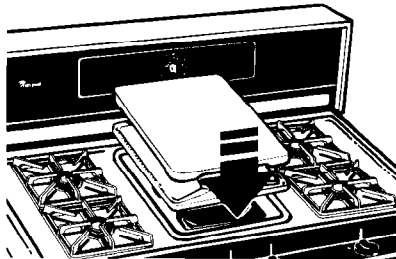
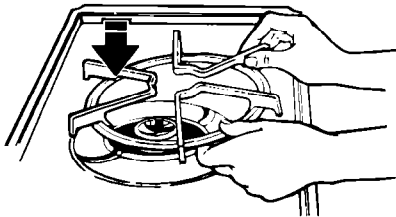
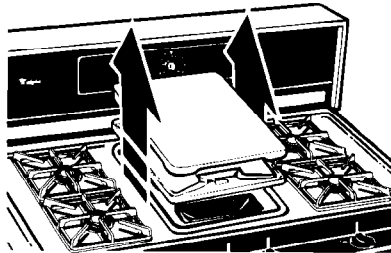
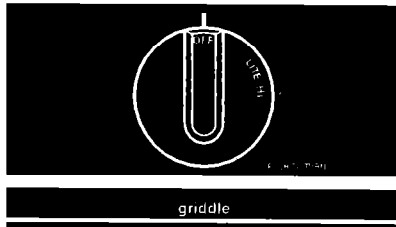

Using the fifth surface burner

1. Make sure the Griddle/Fifth Burner Control Knob is turned to OFF and the griddle is cool.

2. Remove the griddle cover and griddle from the cooktop.

3. Install the fifth burner assembly and grate. Use this burner as you would any other surface burner. (See control setting guide on page 6.)

4. After cooking is complete and fifth burner grate is cool, remove the grate and install the griddle and griddle cover. Store the grate in the storage compartment or a convenient place.

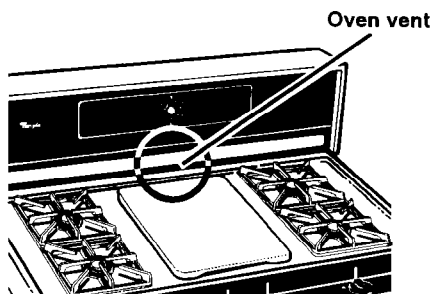

The oven vent

Hot air and moisture escape from the oven through a vent just under the backguard. The vent is needed for air circulation. **Do not block the vent.** Poor baking/roasting will result.

NOTE: Never store plastics, paper or other items that could melt or burn near the oven vent, or any of the surface burners.

⚠ WARNING

Burn Hazard

When the oven is on, and pans and pan handles are left near the oven vent, use pot holders to move pans.

Failure to do so could result in burns.

Caring For Your Range

⚠ WARNING

Explosion Hazard

Keep appliance area clear and free of combustible materials, gasoline, and other flammable vapors and liquids.

Make sure all controls are off and the range is cool before cleaning.

Do not use oven cleaners, bleach, or rust removers.

Do not obstruct the flow of combustion and ventilation air.

Failure to follow these guidelines could result in explosion, fire, electrical shock, or burns.

Control panel and knobs

1. Make sure all control knobs are turned off.
2. Pull control knobs straight off.

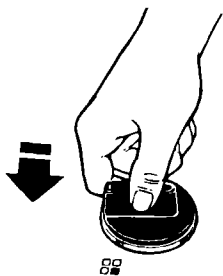
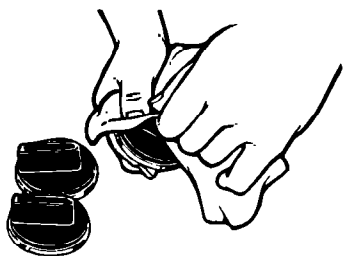
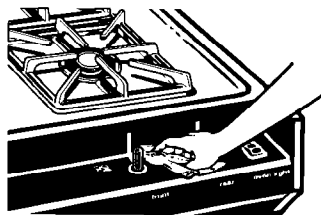
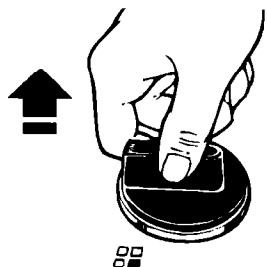

3. Use warm, soapy water and a sponge or spray glass cleaner and a paper towel to wipe the control panels. Wipe with clean water and dry with a paper towel.
4. Wash control knobs in warm, soapy water. Rinse well and dry with a paper towel. Do not soak.
5. Replace control knobs by pushing them firmly into place.

NOTE: When cleaning, never use steel wool, abrasives, or commercial oven cleaners which may damage the finish. After cleaning, make sure all control knobs point to OFF.

Caring For Your Range
Continued

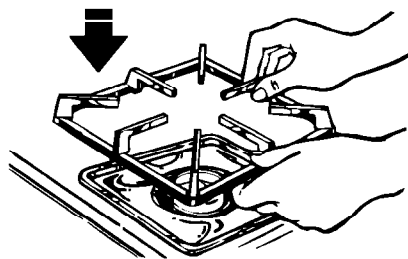
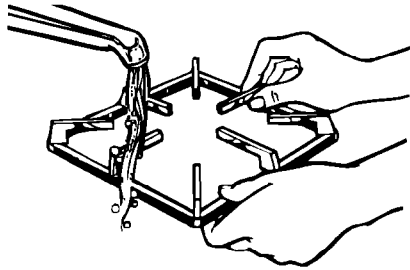
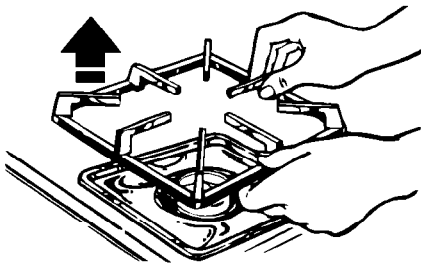
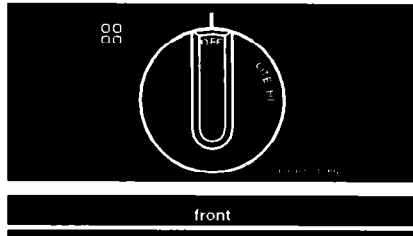

Surface burner grates, reflector pans and griddle

1. Make sure all surface burners are off and the surrounding parts are cool.
2. Lift off the burner grates, reflector pans and/or griddle and cover.
3. Wash the grates and reflector pans with warm, soapy water or in a dishwasher. Wash the griddle and cover with warm, soapy water. Use a nonabrasive, plastic scrubbing pad for cooked-on food. Rinse and dry well.
4. Replace reflector pans, burner grates and/or griddle and cover.

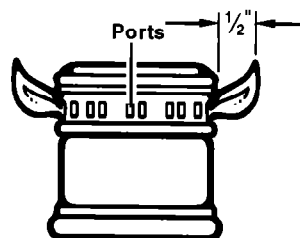
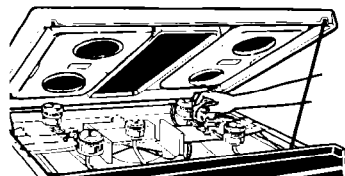

Typical surface burner flame at highest setting

Surface burners

Lift up and secure the cooktop, following instructions under "Lift-up cooktop" below.

Wipe off surface burners with warm, soapy water and a sponge after each use.

Occasionally check the burner flames for proper size and shape as shown. A good flame is blue in color. If flames lift off ports, are yellow, or are noisy when turned off, you may need to clean the burners (see "Cleaning tips" on page 19), or call a qualified technician for adjustment.

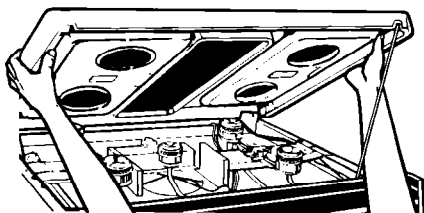
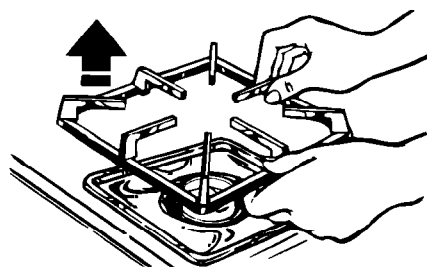

Lift-up cooktop

1. Remove surface burner grates and reflector pans. Also remove griddle cover, griddle and insert (under griddle).

2. Lift front of cooktop, and swing up the support rod. Do not raise cooktop high enough to hit the backguard.

3. Carefully lower the cooktop onto the support rod. Be sure the support rod fits in the corner notch of the cooktop.

Caring For Your Range
Continued

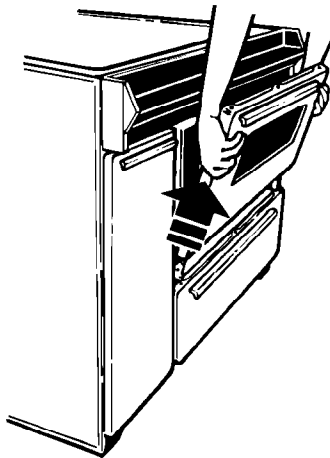
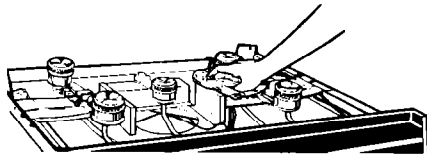

⚠ WARNING

Personal Injury Hazard

Do not try to clean under the cooktop without first securing the support rod. If cooktop is not setting firmly on rod, the cooktop could accidentally fall and injure you.

NOTE: Do not drop the cooktop. Damage can result to porcelain and the cooktop frame.

4. Wipe surface under the cooktop with warm, soapy water. Use a soap-filled plastic scrubbing pad on heavily soiled areas.
5. Lift front of cooktop slightly, and swing support rod down. Lower front of cooktop. Avoid hitting the control panel. Replace reflector pans, surface burner grates, insert, griddle and griddle cover.

Removable oven door

Removing the oven door will help make it easier to clean the oven.

⚠ WARNING

Electrical Shock Hazard

Make sure all controls are off and the oven is cool before removing oven door. Failure to do so can result in electrical shock or burns.

1. Open the door to the first stop position.
2. Hold the door at both sides and lift it **at the same angle it is in.**
3. **To replace,** fit the bottom corners of the door over the ends of the hinges.
Push the door down evenly. The door will close only when it is on the hinges correctly.

Removing the broiler carriage

The broiler carriage can be removed for ease of cleaning.

To remove:

1. Pull broiler drawer open.
2. Remove broiler pan and grid.

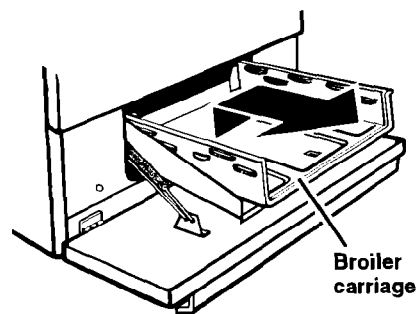
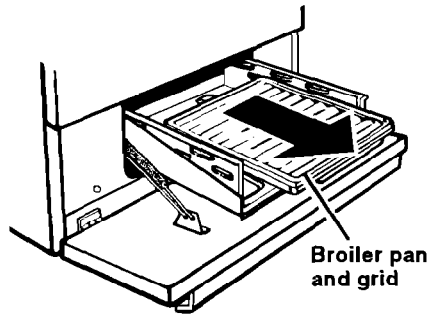

3. Slightly lift broiler carriage and pull all the way out.

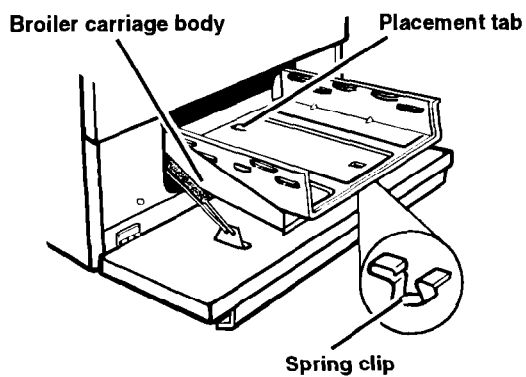

To replace:

1. Push broiler carriage in until carriage is locked under placement tab in rear of broiler carriage body. Make sure spring clip at front of carriage snaps into slot in broiler carriage body. **Carriage must be snapped into body whenever you are baking.**
2. Replace broiler pan and grid.
3. Close broiler drawer all the way.

Using the standard-cleaning oven

The standard-cleaning oven has to be hand-cleaned. Use warm, soapy water, soapy steel-wool pads or a commercial oven cleaner. See "Cleaning tips" on page 19 for further instructions.

Using foil

To catch sugar or starchy spills from pies and casseroles, use a piece of heavy-duty aluminum foil or a shallow pan on the lower rack, slightly larger than the cooking container.

WARNING

Burn Hazard

Make sure all controls are off and the oven is cool before using foil.

Failure to do so could result in burns.

NOTES:

- Do not use foil to cover oven floor or to completely cover a rack. Good air circulation is needed for the oven to operate properly. Poor cooking results could occur.
 - Do not allow commercial oven cleaner to contact the heat seal, thermostat, or exterior surfaces of the oven. Damage will occur.
1. Turn off all controls.
 2. **Put foil or pan under the cooking container.** Make sure the foil is centered and large enough to catch any spillovers.

Cleaning tips

Control knobs

Clean with warm, soapy water and a sponge.

- Turn knobs to off and pull straight away from control panel.
- Wash, rinse and dry well.
- Do not soak.
- **Do not use steel wool or abrasive cleansers. They may damage the finish of the knobs.**
- Replace knobs. Make sure all knobs point to OFF.

Control panels

Clean with a sponge and warm, soapy water or paper towel and spray glass cleaner.

- Wash, wipe with clean water and dry well.
- Follow directions provided with the cleaner.

- **Do not use steel wool or abrasive cleansers. They may damage the finish.**
- Do not spray cleaner directly on panel. Apply cleaner to paper towel.

Exterior surfaces (other than control panels)

Clean with warm, soapy water and a sponge.

- Wipe off regularly when cooktop and oven are cool.

Use a nonabrasive, plastic scrubbing pad for heavily soiled areas.

- Do not use abrasive or harsh cleaners. They could damage the finish.

NOTE: Do not allow food containing acids (such as vinegar, tomato or lemon juice) to remain on surface. Acids may remove the glossy finish. Also, wipe up milk or egg spills when cooktop is cool. Be careful when cleaning around model and serial number plate; the numbers wipe off easily.

Surface burners

Clean with warm, soapy water and a sponge.

- Lift up cooktop (see page 15).
- Wipe off spills immediately after burner has cooled.

For cooked-on food:

- Remove burner from manifold with Phillips screwdriver.
- Wash with warm, soapy water and a nonabrasive, plastic scrubbing pad or soak in vinegar and water solution.
- Rinse and dry well.
- If ports are clogged, clean with a straight pin.
Do not enlarge or distort port. Do not use a wooden toothpick.
- Do not clean surface burner in dishwasher.

Surface burner grates and chrome reflector pans

Clean with warm, soapy water and a nonabrasive, plastic scrubbing pad.

- Wash, rinse and dry well.

OR

Clean in a dishwasher.

Griddle, drip pan and cover

Clean with warm, soapy water and a sponge or nonabrasive, plastic scrubbing pad.

- Clean after each use.
- Remove griddle and drip pan (located under the griddle) to wash, rinse and dry well.
- **Do not use metal scouring pads or harsh cleansers.**
- Use a nonabrasive, plastic scrubbing pad for cooked-on food.

Broiler drawer, pan and grid

Clean with warm, soapy water and a nonabrasive, plastic scrubbing pad.

- Clean after each use.
- Wash pan and grid. Rinse and dry well.
- **After broiler is cool**, wipe interior with warm, damp sponge. For cooked-on food, use a soapy steel-wool pad.

Oven racks

Clean with warm, soapy water and steel-wool pads.

- Wash, rinse and dry. Use soapy steel-wool pads for heavily soiled areas.

Oven door glass

Use paper towel, spray glass cleaner or warm, soapy water and a nonabrasive, plastic scrubbing pad.

- Make sure oven is cool.
- Follow directions provided with the cleaner.
- Wash, rinse and dry well.

Standard-cleaning oven

Clean with warm, soapy water or soapy steel-wool pads.

- Make sure oven is cool.
- Remove door for easier access.
- Clean heavily soiled areas or stains. Wipe well with water.

OR

Use commercial oven cleaners.

- Remove door for easier access.
- Place newspaper on floor to protect floor surface.
- Follow directions provided with the oven cleaner.
- Wipe well with clear water.
- Use in well-ventilated room.
- **Do not allow commercial oven cleaners to contact the heat seal, thermostat or exterior surfaces of the range. Damage will occur.**

Place piece of heavy-duty aluminum foil or shallow pan, slightly larger than the cooking container, on lower rack to catch spillovers.

Using and replacing the light bulbs

The cooktop light

The fluorescent light is on the bottom of the control panel. The Cooktop Light Switch is located on the left side of the front control panel.

⚠ WARNING

Electrical Shock Hazard

Make sure power to the range has been disconnected at the main power supply and that all surface burners are off and cool.

Failure to follow the above could result in electrical shock or burns.

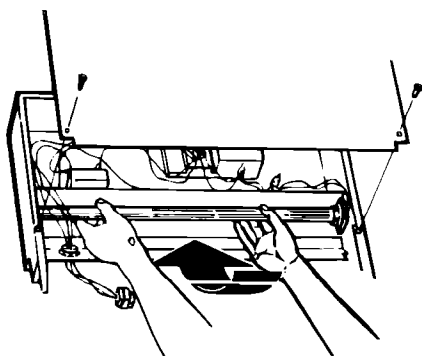
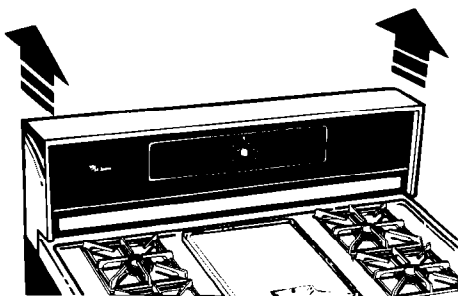

To replace the cooktop light:

1. Turn off the control knobs and unplug appliance or disconnect at the main power supply.
2. Lift up the cooktop and disconnect the electrical plug to the backguard. Lower the cooktop.
3. Grasp each side of the backguard and lift it straight up.
4. Turn backguard over. Remove the four screws holding the back cover panel, then remove the cover.
5. Roll bottom of fluorescent tube away from you until both ends can be removed from the receptacles. Replace with a 25-watt cool-white fluorescent tube.
6. Replace the back cover panel and screws.
7. Replace the backguard. Reconnect the electrical plug under the cooktop.
8. Plug in appliance or reconnect at the main power supply.

The oven light

The oven light will come on when you push the Oven Light Switch on the right side of the front control panel. Push the switch again to turn off the light.

⚠ WARNING

Electrical Shock Hazard

Make sure oven and light bulb are cool and power to the range has been turned off before replacing the light bulb.

Be careful not to drop the bulb.

Failure to follow the above could result in electrical shock, burns, or injury from broken glass.

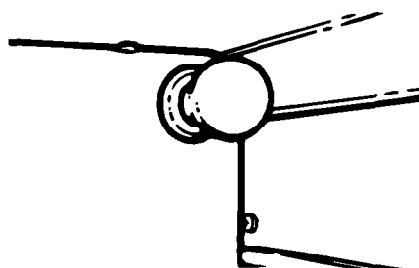
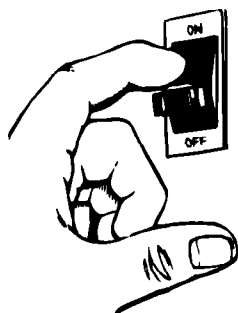

To replace the oven light:

1. Unplug appliance or disconnect at the main power supply.
2. Remove the light bulb from its socket. Replace with a 40-watt appliance bulb. Plug in appliance or reconnect at the main power supply.

If You Need Service Or Assistance ...

We suggest you follow these steps:

1. Before calling for assistance ...

Performance problems often result from little things you can find and fix without tools of any kind.

If nothing operates:

- Is the gas turned on?
- Is the power supply cord plugged into a live circuit with the proper voltage? (See Installation Instructions.)
- Is range properly connected to gas supply? (See Installation Instructions.)
- Have you checked your home's main fuses or circuit breaker box?
- Have instructions in this book been followed?
- Is the control knob set in the correct position?
- Is the Oven Temperature Control Knob turned to a setting?
- Recheck suspected defect.

If burner fails to light:

- Is the range connected to electrical power?
- Have you checked your home's main fuses or circuit breaker box?
- Are burner ports clogged? See page 19.

If burner flames are uneven:

- Are burner ports clogged? See page 19.

If burner flames lift off ports, are yellow, or are noisy when turned off:

- The air/gas mixture may be incorrect. (Call for service.)

If burner makes a popping noise when ON:

- Is the burner wet from washing? Let dry.

If control knob(s) will not turn:

- Did you push in before trying to turn?

If cooking results are not what you expected:

- Is the range level?
- Does the oven temperature seem too low or too high? See page 9.
- If needed, have you preheated the oven as the recipe calls for?
- Does the flame size fit the cooking utensil being used?
- Does the recipe you are using need to be altered to improve the taste or appearance of the food?
- If baking, have you allowed 1½ to 2 inches (4-5 cm) on all sides of the pans for air circulation? There must be a minimum space of 1 inch (3 cm) of space.
- Are the pans the size called for in the recipe?
- Do the cooking utensils have smooth, flat bottoms and fit the surface burners being used?
- When broiling, have you completely closed the broiler drawer?
- Is the flow of combustion and/or ventilation air to the unit obstructed? **Do not obstruct airflow to and around unit.**

2. If you need assistance* ...

Call Whirlpool Consumer Assistance Center telephone number. Dial toll-free from anywhere in the U.S.A.:

1-800-253-1301

and talk with one of our trained consultants. The consultant can instruct you in how to obtain satisfactory operation from your appliance or, if service is necessary, recommend a qualified service company in your area.

If you prefer, write to:

Mr. William Clark
 Consumer Assistance Representative
 Whirlpool Corporation
 2000 North M-63
 Benton Harbor, MI 49022-2692

Please include a daytime phone number in your correspondence.

3. If you need service* ...

Whirlpool has a nationwide network of authorized Whirlpool service companies.



Whirlpool service technicians are trained to fulfill the product warranty and provide after-warranty service,

anywhere in the United States. To locate the authorized Whirlpool service company in your area, call our Consumer Assistance Center telephone number (see Step 2) or look in your telephone directory Yellow Pages under:

• **APPLIANCE-HOUSEHOLD-MAJOR, SERVICE & REPAIR**
 - See: Whirlpool Appliances or Authorized Whirlpool Service
 (Example: XYZ Service Co.)

• **WASHING MACHINES & DRYERS, SERVICE & REPAIR**
 - See: Whirlpool Appliances or Authorized Whirlpool Service
 (Example: XYZ Service Co.)

4. If you need FSP® replacement parts* ...

FSP is a registered trademark of Whirlpool Corporation for quality parts. Look for this symbol of quality whenever you need a replacement part for your WHIRLPOOL appliance. FSP replacement parts will fit right and work right, because they are made to the same exacting specifications used to build every new WHIRLPOOL appliance.

To locate FSP replacement parts in your area, refer to Step 3 above or call the Whirlpool Consumer Assistance Center number in Step 2.

5. If you are not satisfied with how the problem was solved* ...

- Contact the Major Appliance Consumer Action Program (MACAP). MACAP is a group of independent consumer experts that voices consumer views at the highest levels of the major appliance industry.
- Contact MACAP only when the dealer, authorized servicer and Whirlpool have failed to resolve your problem.
 Major Appliance Consumer Action Program
 20 North Wacker Drive
 Chicago, IL 60606
- MACAP will in turn inform us of your action.

* When requesting assistance, please provide: model number, serial number, date of purchase, and a complete description of the problem. This information is needed in order to better respond to your request.

WHIRLPOOL®

Gas Range Warranty

LENGTH OF WARRANTY	WHIRLPOOL WILL PAY FOR
FULL ONE-YEAR WARRANTY From Date of Purchase	FSP® replacement parts and repair labor to correct defects in materials or workmanship. Service must be provided by an authorized Whirlpool service company.
WHIRLPOOL WILL NOT PAY FOR	
<p>A. Service calls to:</p> <ol style="list-style-type: none"> 1. Correct the installation of your range. 2. Instruct you how to use your range. 3. Replace house fuses or correct house wiring or plumbing. 4. Replace owner-accessible light bulbs. <p>B. Repairs when your range is used in other than normal, single-family household use.</p> <p>C. Pickup and delivery. Your range is designed to be repaired in the home.</p> <p>D. Damage to your range caused by accident, misuse, fire, flood, acts of God, or use of products not approved by Whirlpool.</p> <p>E. Repairs to parts or systems caused by unauthorized modifications made to the appliance. 3/95</p>	

WHIRLPOOL CORPORATION SHALL NOT BE LIABLE FOR INCIDENTAL OR CONSEQUENTIAL DAMAGES. Some states do not allow the exclusion or limitation of incidental or consequential damages so this exclusion or limitation may not apply to you. This warranty gives you specific legal rights, and you may also have other rights which vary from state to state.

Outside the United States, a different warranty may apply. For details, please contact your authorized Whirlpool distributor or military exchange.

If you need service, first see the "If You Need Service or Assistance" section of this book. After checking "If You Need Service or Assistance," additional help can be found by calling our Consumer Assistance Center telephone number, **1-800-253-1301**, from anywhere in the U.S.A.