

Installation instructions for your new

Spacemaker™ Laundry WSM2700 Electric

Before you begin - Read these instructions completely and carefully.

IMPORTANT - OBSERVE ALL GOVERNING CODES AND ORDINANCES.

Note to Installer - Be sure to leave these instructions with the Consumer.

Note to Consumer - Keep these instructions with your Use and Care Book for future reference.



WARNING - POTENTIAL FIRE AND SHOCK HAZARD

- Use only rigid metal or flexible metal 4" diameter ductwork inside the dryer cabinet or for exhausting to the outside. Use of plastic or other combustible ductwork can cause a fire. Foil or other easily punctured ductwork can cause a fire if it collapses or becomes restricted in use or during installation.
- This appliance must be properly grounded and installed as described in these instructions.

Important

- Exhausting the dryer to the outside is strongly recommended to prevent large amounts of moisture and lint from being blown into the room.
- Service information and wiring diagram located in dryer access panel.

Tools Required

- Slip joint pliers
- Phillips head and flat blade screwdrivers
- Ratchet with 3/8" socket
- Carpenter's level

Contents:

INSTALLATION PROCEDURE -	Page 2
PLUMBING INFORMATION -	Page 4
ELECTRICAL INFORMATION -	Page 5
EXHAUST INFORMATION -	Page 6
MOBILE HOME INSTALLATION -	Page 7
ALCOVE & CLOSET INSTALLATION -	Page 8
MISCELLANEOUS REQUIREMENTS -	Page 8
INSIDE EXHAUSTING -	Page 8

Product Dimensions

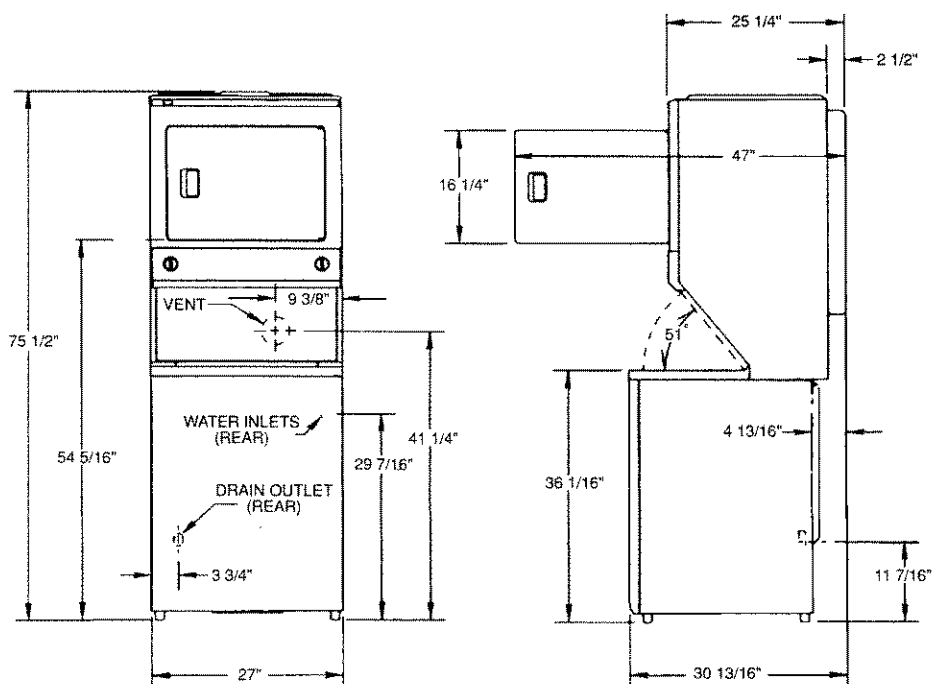

Installation

Unpacking Spacemaker™

STEP 1 - Remove tape and two corner pads from rear bottom corners of appliance.

STEP 2 - Using the four shipping corner posts, lay the appliance on its left side so the shipping base does not rest on the floor.

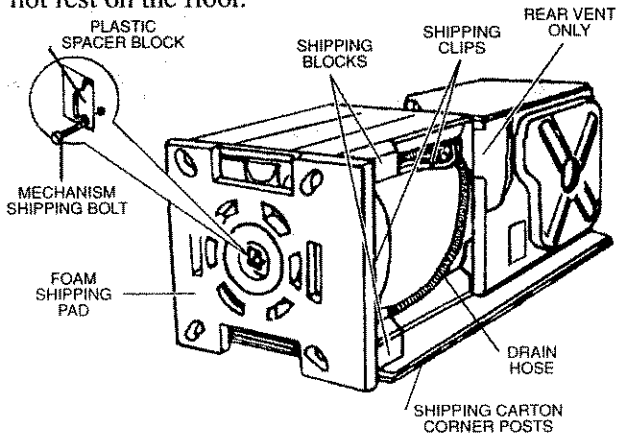

STEP 3 - Remove the foam shipping pad.

STEP 4 - Remove the washer shipping bolt using the ratchet with 3/8" socket and remove the plastic spacer block using the slip joint pliers.

STEP 5 - Return the appliance to the upright position and locate it in the general area to be installed. Provide enough space at the rear for installing the water inlet hose.

STEP 6 - Untape and open washer lid.

STEP 7 - Remove:

- (a) foam tub blocking pad.
- (b) foam shipping blocks from rear of unit.
- (c) tape from dryer door.
- (d) foam dryer support pads.
- (e) inlet hose bag.
- (f) From the back of the washer, remove only the **WIRE** shipping clips that secure the drain hose to the left side of the washer backsheet. **DO NOT REMOVE THE PLASTIC CLAMPS** on the right side of the washer. These clamps form a standpipe to prevent water siphoning.

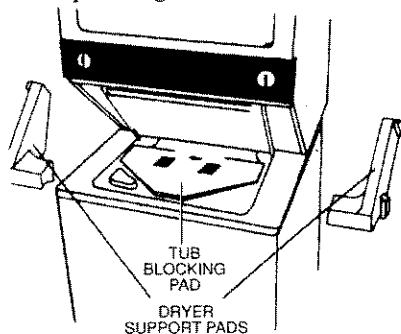

INSTALLATION (cont.)

NOTE: The tub blocking pad, shipping bolt and plastic spacer should be retained for use if the appliance is transported at a later date.

STEP 8 - Form a "U" shape on the end of the drain hose with hose pointed toward the drain. For an installation requiring a longer drain hose, use WH41X0387 (Approximately 112"). This drain hose attaches directly to the pump and should be installed by a qualified technician.

Inlet Hose Connections:

STEP 9 - Remove the inlets hoses and rubber washers from the plastic bag.

STEP 9A - Install the rubber washers in each end of the inlet hoses.

STEP 9B - Carefully connect the inlet hose marked "HOT" to the bottom outlet of the water valve. Tighten by hand, then tighten another 2/3 turn with pliers. Carefully connect the other inlet hose to the top outlet of the water valve. Tighten by hand, then tighten another 2/3 turn with pliers.

Power Cord Connection:

See Electrical Connection Information

INSTALLATION (cont.)

Moving Spacemaker™ to Operating Location:

STEP 10 - Remove the two screws securing the access panel to the dryer cabinet. Lift front access panel until the tabs can be disengaged from dryer cabinet and remove panel.

STEP 11 - Route inlet hoses, drain hose and power cord through access area for temporary holding when moving appliance to operating location.

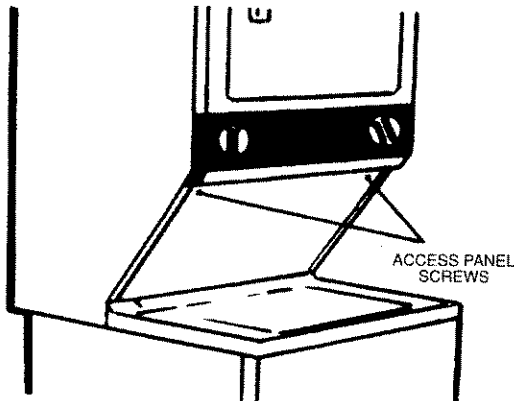

STEP 12 - To ensure the Spacemaker™ is level and solid on all four legs, tilt the Spacemaker™ forward so the rear legs are off the ground. Gently set the Spacemaker™ back down to allow the rear legs to self adjust. Place a level on top of the washer. Check it side to side, then front to back. Screw the front leveling legs up or down to ensure the Spacemaker™ is resting solid on all four legs (no rocking of the Spacemaker™ should exist).

NOTE: Keep leg extension at a minimum to prevent excessive vibration.

Connection to Plumbing Facilities:

CAUTION: Be sure water supply lines have been thoroughly flushed to remove particles that might clog the washer filter screens.

(continued)

INSTALLATION (cont.)

STEP 13 - Determine which water faucet is the **HOT** water faucet and carefully connect the bottom inlet hose to the **HOT** water faucet, tighten by hand, then tighten another 2/3 turn with pliers. Carefully connect the top inlet hose to the **COLD** water faucet, tighten by hand, then tighten another 2/3 turn with pliers.

CAUTION: DO NOT CROSS THREAD OR OVERTIGHTEN THESE CONNECTIONS.

Turn the water on and check for leaks at both connections.

STEP 13A - Place formed end of drain hose in drain facility and secure with cable tie (provided in literature package).

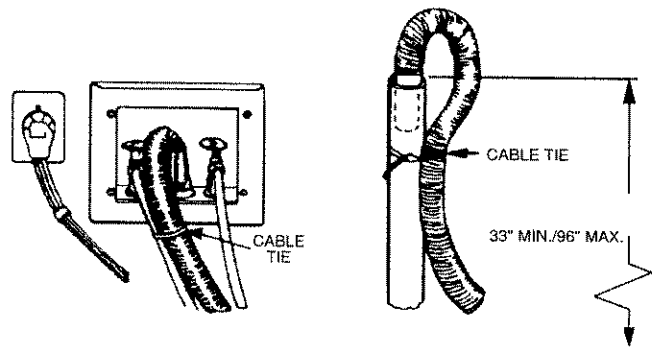

NOTE: - Drain hose **MUST** be secured to drain facility in all cases.

Connecting to Power Supply:

NOTE: - For special electrical installations, see **ELECTRICAL INFORMATION** section page 5 and 6.

CAUTION: Be sure electricity is **OFF** at power supply source (circuit breaker/fuse box).

STEP 14 - Plug power cord to electrical outlet.

Connecting to Exhaust:

STEP 15 - Connect the exhaust duct to outside ductwork. Use duct tape to seal all joints. See Exhaust Information.

Final Appliance Leveling:

CAUTION: ALL WEIGHT MUST BE REMOVED FROM APPLIANCE LEVELING LEG WHILE ADJUSTING. THREADS ON LEG WILL BE DAMAGED OTHERWISE.

STEP 16 - Again, make sure the appliance rests firmly on all four legs. No rocking of the appliance should exist.

(continued)

INSTALLATION (cont.)

Appliance Operational Checkout:

STEP 17 - All packing and shipping materials removed including the washer shipping bolt and plastic spacer block.

STEP 17A - Drain hose properly routed - not coiled or kinked.

STEP 17B - Water inlet hoses connected (HOT to HOT) and tightened securely without kinks. Turn on water faucets and check for leaks.

STEP 17C - Exhaust ductwork secured without leaks by taping all joints.

STEP 17D - Turn on electricity at power source.

STEP 17E - Turn on washer and dryer and run through one cycle. Check all hoses for leaks.

Replacing Front Access Panel:

STEP 18 - Re-install front access panel removed in STEP 10.

STEP 19 - Place Use and Care Book and Installation in location where they may be found by the customer.

Plumbing Information

Water Supply Requirements

- **HOT AND COLD WATER FAUCETS** must be within 42" of the appliance water inlet hose connections. The faucets must be 3/4" garden-hose type so inlet hoses can be connected.
- **WATER PRESSURE** - Must be between 10 and 120 pounds per square inch with a maximum unbalance pressure, hot vs. cold flowing, of 10 pounds per square inch.
- **WATER TEMPERATURE** - Water heater should be set to deliver 140 to 150 F (60 to 66 C) IN THE WASHER when HOT wash is selected.
- **SHUT-OFF VALVES** - Both hot and cold water shut-off valves (faucets) should be supplied.
- **LOCATION** - Do not install appliance in an area where the temperature will fall below freezing. If appliance is stored or transported in freezing temperatures, be sure all water from the fill and drain systems has been removed.

Drain Requirements

- **DRAIN RATE** - The drain or standpipe must be capable of accepting a discharge at the rate of 16 gallons per minute.
- **DRAIN HEIGHT** - The drain height must be 33" minimum and 96" maximum.
- **STANDARD DIAMETER** - The standpipe diameter must be 1-1/4" minimum. There **MUST** be an air gap around the drain hose in the standpipe. A snug fit can cause a siphoning action.
- **SIPHON BREAK KIT** - For a drain facility less than 33" high, the hose, coupling and clamps provided in the machine may be used and in addition, a siphon break **MUST** be installed on the back of the machine. Use Siphon Break Kit WH49X228 and **FOLLOW INSTRUCTIONS IN THE KIT.**

Electrical Connection Information

⚠ WARNING - To Prevent Personal Injury:

TURN OFF ELECTRICITY AT POWER SOURCE (CIRCUIT BREAKER / FUSE BOX) BEFORE INSTALLING OR SERVICING THIS APPLIANCE. DO NOT USE AN EXTENSION CORD WITH THIS APPLIANCE.

THIS APPLIANCE MUST BE PROPERLY GROUNDED.

This appliance must be electrically grounded in accordance with local codes and ordinances, or in the absence of local codes, in accordance with the NATIONAL ELECTRICAL CODE, ANSI/NFPA NO. 70-1987.

Electrical Requirements:

- This appliance should be connected to an individual branch circuit with 120/240 or 120/208 volt single phase 60 Hz electrical service and should be protected by 30 amp. time-delay fuses or circuit breakers.
- Use power supply cord kit marked for use with clothes dryers.

Connecting Appliance Using 3-Wire Connection

STEP 1 - Remove the terminal block cover located at the rear of the dryer.

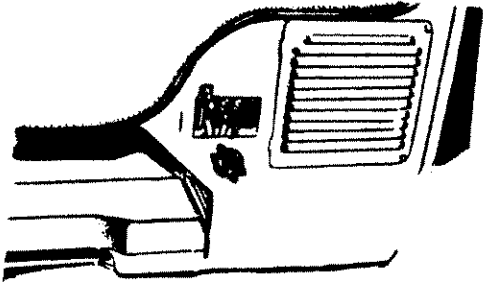

STEP 2 - Install a UL recognized strain relief in the one inch hole on the dryer back below the terminal block opening.

STEP 3 - Install a UL listed 30A, 3 conductor NEMA 10-30R type SRDT cord with 3 open end spade lug connectors with upturned ends or closed loop connectors.

STEP 4 - Connect the center wire of the power cord to the silver colored center terminal screw on the terminal block. Tighten the screw securely.

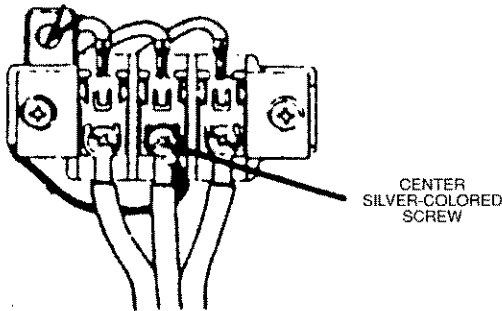

STEP 5 - Connect the two other wires of the power cord to the outer brass colored terminals on the terminal block. Tighten the screws securely.

STEP 6 - Tighten the screws securing the cord to the strain relief.

STEP 7 - Reinstall the terminal block cover.

CAUTION: - Be sure electricity is OFF at power source (circuit breaker/fuse box).

STEP 8 - Plug power cord into electrical outlet.

STEP 9 - Return to Step 14 on Page 3.

NOTE: - THIS APPLIANCE IS NOT APPROVED FOR 120 VOLT OPERATION.

ELECTRICAL (cont.)

3-Wire Connection (Ungrounded Neutral)

This appliance is manufactured with the neutral connected to the frame. If local codes do not permit neutral grounding, proceed as follows:

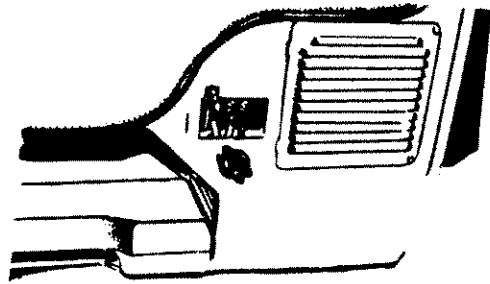

STEP 14 - Remove the terminal block access cover.

STEP 14A - Disconnect the green ground wire from the green ground screw.

STEP 14B - Connect green ground wire to center (silver colored) terminal of terminal block.

STEP 14C - Connect a separate grounding wire (No. 12 or heavier - not supplied) between the green ground screw and a grounded metal cold water pipe or other established ground.

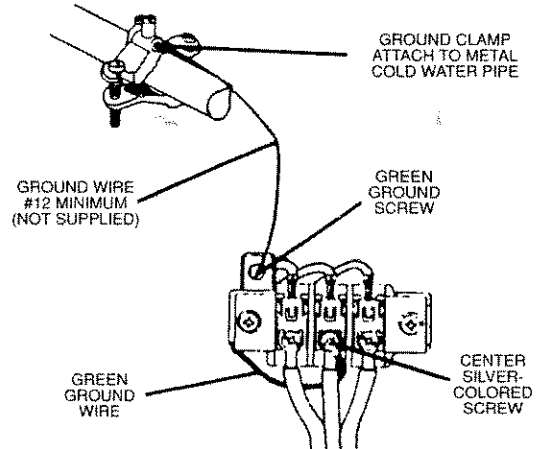

STEP 14D - Re-install the terminal block access cover.

CAUTION: Be sure electricity is OFF at power source (circuit breaker/fuse box).

STEP 14E - Plug power cord into electrical outlet.

STEP 14F - Return to Step 14 on Page 3

NOTE: THIS APPLIANCE IS NOT APPROVED FOR 120 VOLT OPERATION.

ELECTRICAL (cont.)

Connecting Appliance Using 4-Wire Connection

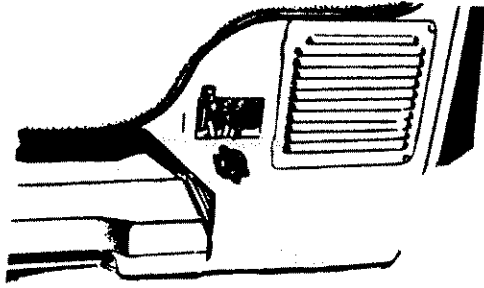

STEP 14 - Remove the terminal block access cover.

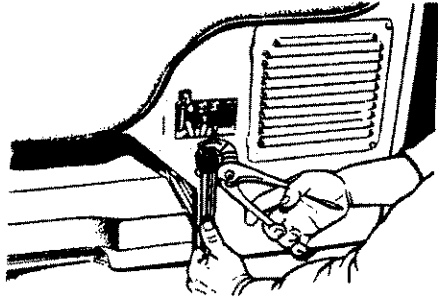

STEP 14A - Install U.L. listed 30A, 4-conductor NEMA 14-30 type ST closed loop terminal power cord and the strain relief.

STEP 14B - Connect the green ground wire of the power cord to the terminal block bracket with the green grounding screw.

STEP 14C - Connect the white wire from the power cord and the green ground wire from the appliance harness to the center (silver) terminal of the terminal block.

STEP 14D - Connect the black and red wires from the power cord to the two outer terminals of the terminal block.

(continued)

ELECTRICAL (cont.)

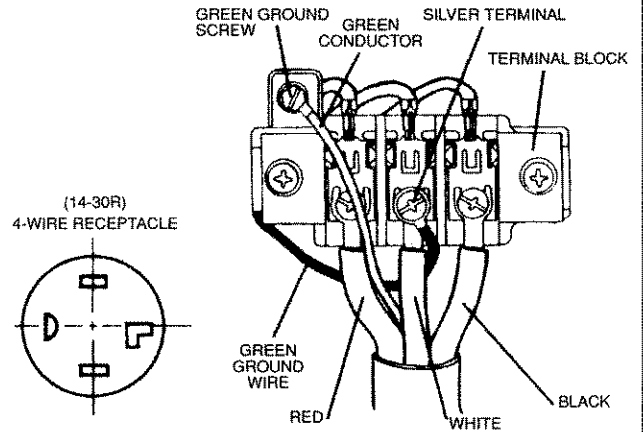

STEP 14E - Check all connection screws for being securely tightened.

STEP 14F - Re-install the terminal block cover.

CAUTION: Be sure electricity is turned OFF at power source (circuit breaker/fuse box).

STEP 14G - Plug power cord into electrical outlet.

STEP 14H - Return to Step 14 on page 3.

NOTE: THIS APPLIANCE IS NOT APPROVED FOR 120 VOLT OPERATION.

Exhaust Information

NOTE: Exhausting the dryer to the outside is strongly recommended to prevent large amounts of moisture and lint from being blown into the room.

CAUTION, FOR PERSONAL SAFETY:

- Use only 4" diameter (minimum) rigid or flexible metal duct. Do not use plastic flexible duct to exhaust the dryer. Excessive lint can build up inside the duct work and create a fire hazard and restrict air flow.
- Restricted air flow will increase drying times.
- Do not terminate exhaust in a chimney, any gas vent, under an enclosed floor (crawl space) or into an attic. The accumulated lint could create a fire hazard or moisture could cause damage.
- Provide an access for inspection and cleaning of external exhaust system, especially at the turns. Inspect and clean at least once a year.
- Never terminate the exhaust into a common duct or plenum with a kitchen exhaust. The combination of lint and grease could create a fire hazard.
- Do not obstruct incoming or exhaust air.

(continued)

EXHAUST (cont.)

Exhaust Duct Length Information

- The MAXIMUM ALLOWABLE length of the exhaust system depends upon the type of duct, number of turns, the type of exhaust hood (wall cap) and all conditions noted below. The maximum allowable length for both rigid and flexible metal is shown in the table below. More than three 90° turns are not recommended.

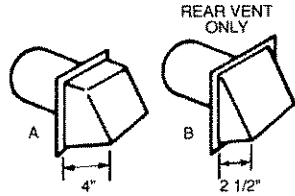

NUMBER OF 90° TURNS	EXHAUST - HOOD TYPE -		
	A	B	
0	56 FT.	42 FT.	MAXIMUM LENGTH OF 4" DIAMETER RIGID METAL DUCT
1	46 FT.	36 FT.	
2	34 FT.	28 FT.	
3	32 FT.	18 FT.	
0	30 FT.	22 FT.	MAXIMUM LENGTH OF 4" DIAMETER FLEXIBLE METAL DUCT
1	22 FT.	14 FT.	
2	16 FT.	10 FT.	
3	10 FT.	5 FT.	

Hood or Wall Cap

- Terminate in a manner to prevent back drafts or entry of birds or other wildlife.
- Termination should present minimal resistance to the exhaust airflow and should require little or no maintenance to prevent clogging.
- Never install screen over exhaust duct.
- Wall caps must be installed at least 12" above ground level or any other obstruction with the opening pointed down.
- If roof vents or louvered plenums are used, they must be equivalent to a 4" dampered wall cap in regard to resistance to air flow, prevention of back drafts and maintenance required to prevent clogging.

Turns Other Than 90°

- One turn of 45° or less may be ignored.
- Two 45° turns should be treated as one 90°.

(continued)

EXHAUST (cont.)

Sealing of Joints

- All joints should be tight to avoid leaks.
- NOTE:** The male end of each section of duct must point away from the dryer.
- Do not assemble ductwork with fasteners that extend into the duct. They will service as a collection point for lint.
- Duct joints can be made air and moisture-tight by wrapping the overlapped joints with duct tape.

Insulation

- Ductwork that runs through an unheated area or is near an air conditioning duct, should be insulated to reduce condensation and lint build-up.

PARTS AVAILABLE FROM LOCAL SERVICE ORGANIZATION

- Rigid Metal Duct Components
 - WX8X63 4" X 1' Duct
 - WX8X64 4" X 2' Duct
 - WX8X51 4" Elbow
 - WX8X59 4" Aluminum Hood
- Flexible Metal Duct Components
 - Kit WX8X66 7' Aluminum duct, 4" hood and 2 clamps
 - WX8X65 7' Aluminum Flexible Duct
 - WX8X58 4" Clamps (2)
 - WX8X59 4" Aluminum Hood

Mobile Home Installation

- Installation must conform to Manufactured Home Construction and Safety Standard, Title 24 CFR, Part 32-80
- The dryer must be exhausted to the outside with the termination securely fastened to the mobile home structure.
- The exhaust MUST NOT be terminated beneath the mobile home.
- The exhaust duct material MUST NOT support combustion.
- For Electrical Connections see "CONNECTING DRYER USING 4-WIRE CONNECTIONS"

CONSIDERATION MUST BE GIVEN TO PROVIDE ADEQUATE CLEARANCES FOR INSTALLATION AND SERVICE.

Alcove or Closet Installation

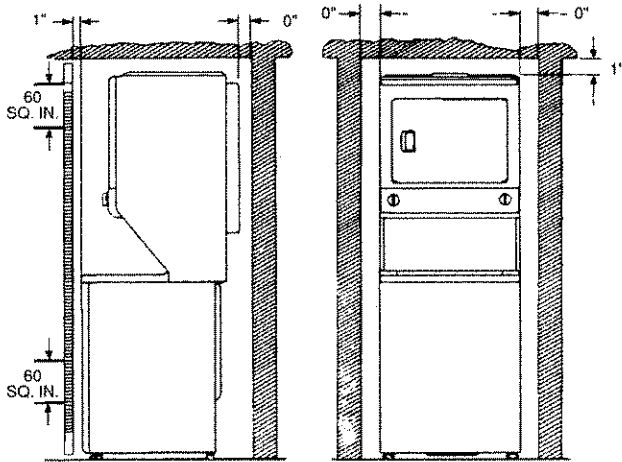

- If your dryer is approved for installation in an alcove or closet, it will be stated on a label on dryer back.
- TO PREVENT LARGE AMOUNTS OF LINT AND MOISTURE FROM ACCUMULATING AND TO MAINTAIN DRYING EFFICIENCY, THIS MACHINE MUST BE EXHAUSTED OUTDOORS.
- DO NOT install this appliance with less than the minimum clearances shown in this chart.

CONSIDERATION MUST BE GIVEN TO PROVIDE ADEQUATE CLEARANCES FOR INSTALLATION AND SERVICE

CAUTION: DO NOT INSTALL THIS APPLIANCE IN A CLOSET WITH A SOLID DOOR.

Door Ventilation Opening

A minimum of 120 square inches of opening, equally divided at top and bottom is required. Air openings are required to be unobstructed when a door is installed. A louvered door with equivalent air openings for the full length of door is acceptable.

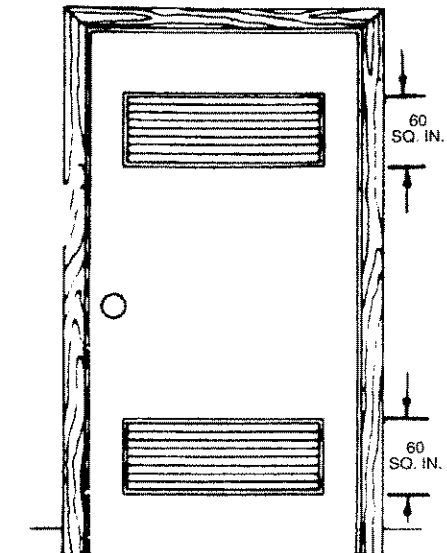

When louvers or registers are placed in door openings, the free air openings of the louvers or registers must equal 120 square inches.

Miscellaneous Requirements:

Location

- Appliance must be installed on firm flooring to minimize vibration during spin cycles. Concrete flooring is best, but wood base is sufficient providing floor support meets FHA standards.
- Appliance should not be installed on rugs or exposed to the weather.

Inside Exhausting

- If the installation makes it impossible to exhaust to the outside, there must be a clearance of 4" between top of appliance and soffit.

SPECIFICATIONS SUBJECT TO CHANGE WITHOUT NOTICE