

Installation Instructions



for
your new



Whirlpool

**ELECTRIC BUILT-IN
OVEN**

**30" DOUBLE OVEN MODELS
(STARTING WITH 1982 MODELS)**

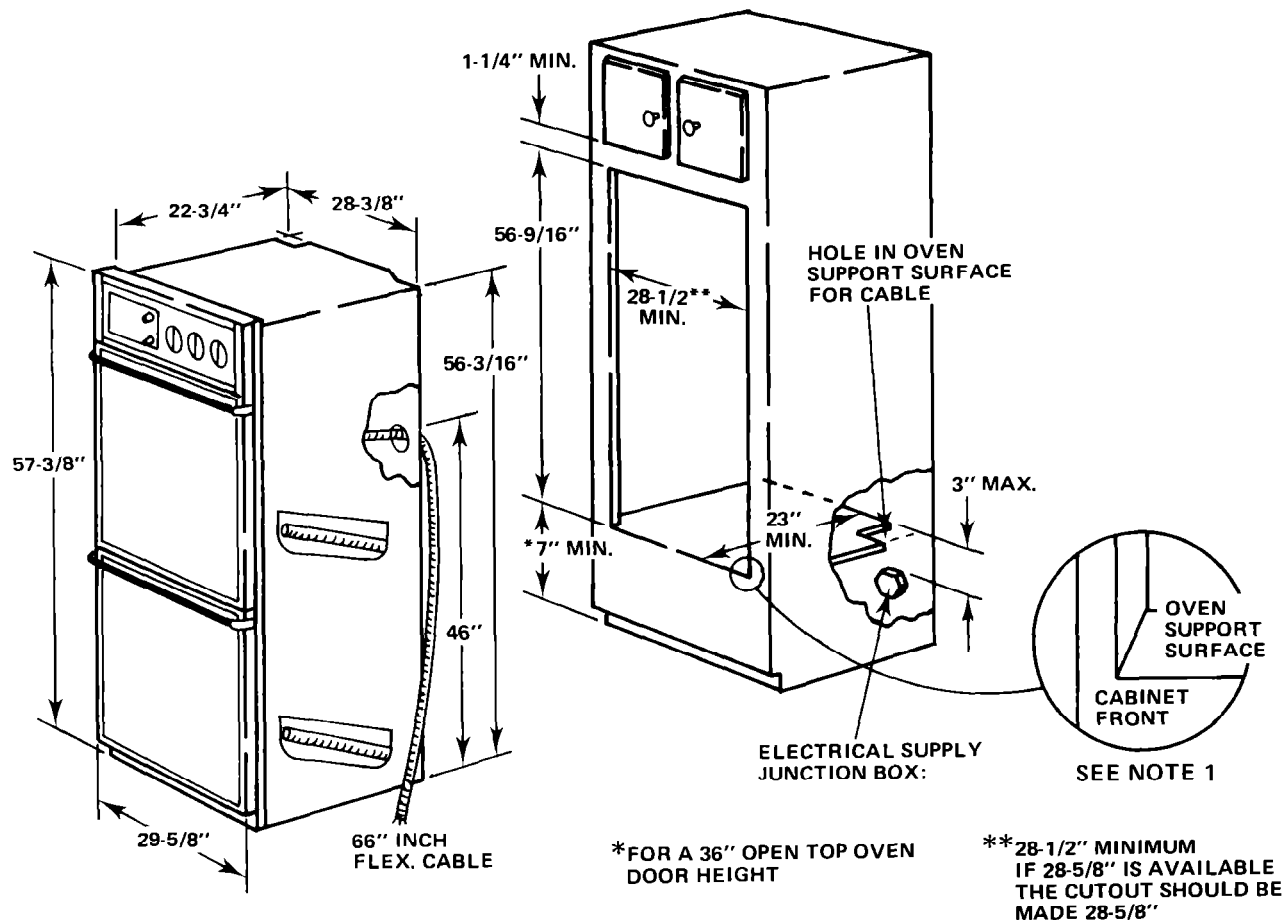

FIGURE 1 – Rough-In Dimensions

1. CARPENTRY

Refer to Figure 1 for the dimensions of the oven and the space necessary to receive the oven. The oven support surface may be solid plywood or similar material but the contact surface must be level from side to side and from front to rear. This surface is 2 3/4" below the open door height.

NOTE 1: The oven support surface must be flush with the bottom of the cabinet cut out.

WARNING: TO AVOID DAMAGE TO CABINET AND/OR POOR BAKE PERFORMANCE, DO NOT BLOCK OVEN VENT.

2. ELECTRICAL REQUIREMENTS

IMPORTANT: OBSERVE ALL GOVERNING CODES AND ORDINANCES

SAVE THESE INSTRUCTIONS FOR THE LOCAL ELECTRICAL INSPECTOR'S USE

- A. A three-wire or four-wire single phase 120/240 volt 60Hz AC only electrical supply (or three-wire or four-wire 120/208 volt if specified on nameplate) is required on a separate circuit fused on both sides of the line (time-delay fuse or circuit breaker is recommended). Do NOT fuse neutral. The fuse size must not exceed the circuit rating of the appliance specified on the nameplate.

NOTE: Wire sizes and connections must conform with the fuse size and rate of the appliance in accordance with the National Electrical Code and local codes and ordinances. Do not use an extension cord.

- B. The appliance should be connected to the fused disconnect (or circuit breaker) box through flexible armored or non-metallic sheathed cable. The flexible armored cable extending from the appliance should be connected directly to the junction box. The junction box should be located as shown in Figure 1 so that as much slack as possible remains in the cable between the box and the appliance so that it can be moved if servicing is ever necessary.
- C. A suitable strain relief must be provided to attach the flexible armored cable to the junction box.
- D. Electrical Connection.

It is the personal responsibility and obligation of the customer to contact a qualified installer to assure that the electrical installation is adequate and is in conformance with the National Electrical Code and local code ordinances.

Electrical ground is required on this appliance.

This appliance is equipped with copper lead wires. If the connection is made to aluminum house wiring, use only special connectors which are approved for joining copper and aluminum wires, in accordance with the National Electrical Code and local codes and ordinances.

This appliance is manufactured with a white neutral power supply wire and a frame-connected green ground wire.

1. If local codes permit connection of the frame-grounding conductor to the neutral (white wire), connect the green and white wire from the supply cable of the appliance together and to the neutral (white) wire in the junction box. Connect the remaining wires from the supply cable, matching the colors, to the wires in the junction box.
2. If local codes DO NOT permit frame grounding to the neutral, separate the white and green wires that extend out of the end of the supply cable of the appliance. Connect the white wire from the supply cable to the neutral wire in the junction box.

Connect the black and red wire from the supply cable, matching the colors, to the corresponding wires in the junction box. The green wire MUST now be used to ground the appliance in accordance with local electrical codes. Connect the green ground wire to a grounded cold water pipe* or to the grounded lead in the service panel. **Do not ground to a gas supply pipe.** Do not connect to electrical power supply until appliance is permanently grounded. Connect the ground wire before turning on the power. See Figure 2.

CAUTION — If connecting to a four-wire electrical system (MOBILE HOME) the appliance frame **MUST NOT** be connected to the neutral wire of the four-wire electrical system. Separate the white and green wires that extend out of the end of the supply cable of the appliance. Connect the white, red and black wires from the supply cable, matching the colors, to the corresponding wires in the junction box. Connect the green wire from the supply cable to the ground wire in the junction box.

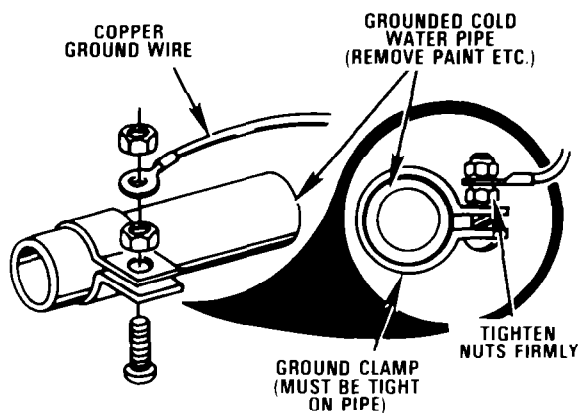

FIGURE 2

*Cold water pipe must have metal continuity to electrical ground and not be interrupted by plastic, rubber or other electrically insulating connectors (including water meter or pump) without adding a jumper wire at these connections.

4. INSTALLATION

NOTE:

Before installing the oven in the cutout, it may be helpful to remove the oven door. See details below.

Insert appliance into cut-out. Screws are provided for fastening the front frame of the appliance to the cabinet. The mounting holes in the front frame of appliance may be used as a template to locate the appliance mounting screw holes.

CAUTION: For your personal safety, and to minimize potential personal injury, this oven must be securely fastened to the cabinet, using the four screws that are provided.

Use caution when mounting oven in cutout so you do not overtighten screws and cause porcelain chipping or puncture oven cavity.

TO REMOVE OVEN DOOR

SELF-CLEANING MODELS — LOWER OVEN DOOR ONLY (Door to be removed for installation only).

1. Remove the two screws, one on each side of the inner door panel. See View A.

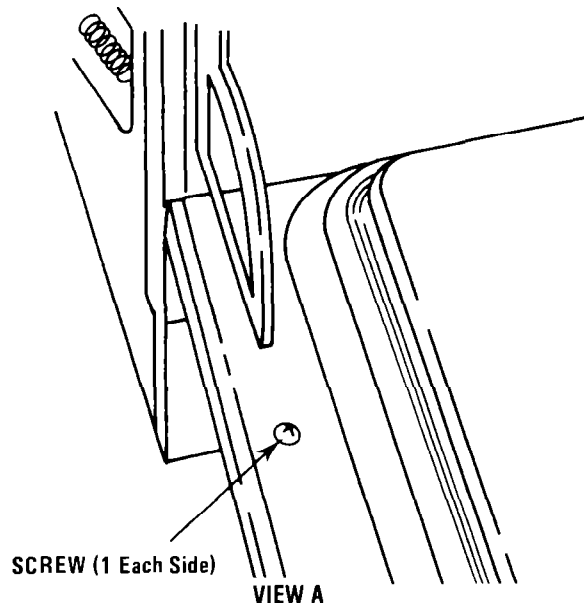

WARNING: UNDER NO CIRCUMSTANCES ARE THESE DOOR TO BE INTERCHANGED.

2. Put an allen wrench (5/32" or smaller) or equivalent in the hole in each of the hinges. Close the oven door until the pins touch the oven front. See View B.
3. The oven door can now be lifted off.
4. Reinstall oven door the same as on non-self cleaning models (see below).
5. Reinstall the door mounting screws.

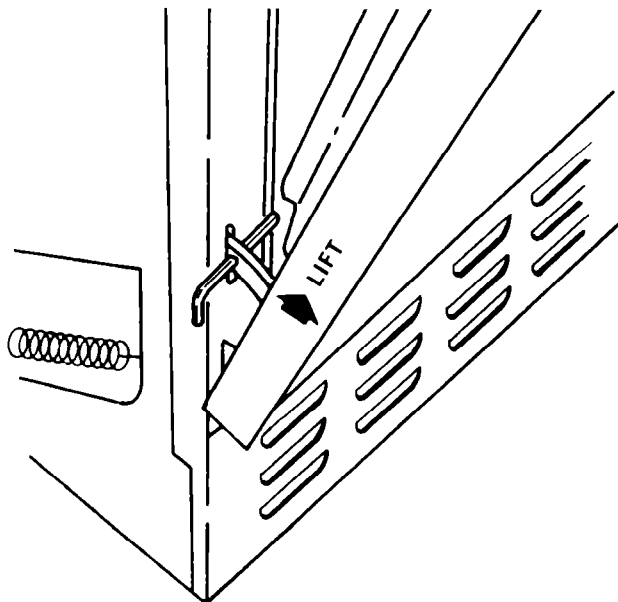

VIEW B

TO REMOVE OVEN DOOR (LOWER OVEN DOOR SELF CLEANING MODELS, BOTH OVEN DOORS NON SELF CLEANING OVEN MODELS),

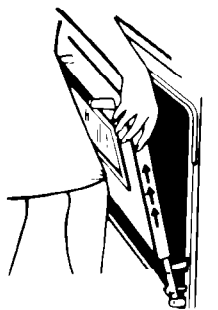

Pull straight with the angle of part-open door.



Push down evenly.

Removing the oven door: (For installing and cleaning)

Removing the oven door may make it easier to clean the oven. To remove the door, first open it to the first stop (about 4 inches or 10 cm). Take hold of both sides of the door near the top; then lift it **at the same angle it is in.**

With the door off, you will notice how the ends of the hinges slide into slots at the bottom corners of the door. To put the door back on, fit both bottom corners of the door over the ends of the hinges. Push the door down evenly, so neither corner gets ahead of the other. When it reaches the bottom, you can close the door. A safety latch will hold the door open until it is on correctly.

5. CHECKING

CAUTION: Do not touch the elements. They may be hot and you may get burned.

A. THERMOSTAT

1. Broil — Turn selector switch to BROIL and set thermostat to a high temperature position. The top element should become cherry-red and the indicator light should glow.
2. Bake — Turn selector switch to BAKE and set thermostat to 350°. The bottom element should become red and the indicator light should glow.

B. CLOCK

Refer to the Use and Care Guide for proper operation of the clock.

C. ROTISSERIE (if optional kit has been installed)

1. Position the spit bar on special rack.
2. Insert point of spit bar into hole in the back of the oven.
3. Rotation starts upon insertion of spit bar.



In the event your WHIRLPOOL appliance should need service, call the dealer from whom you purchased the appliance or a WHIRLPOOL franchised TECH-CARE® service company. He is in the Yellow Pages of your telephone directory listed under Washers, Dryers—Repairing or Servicing. You can also obtain his name and number by dialing, free, within the continental United States (except Alaska) the Whirlpool COOL-LINE® Service (800) 253-1301 [when calling from Michigan, dial (800) 632-2243; from Alaska or Hawaii, dial (800) 253-1121]. Dial just as you normally dial long distance. A special operator will tell you the name and number of your nearest Whirlpool TECH-CARE service outlet. During normal working hours, Whirlpool consultants at this same number will also answer any questions about operating or maintaining your appliance not covered in your Operating Instructions.

Learn the benefits of using TECH-CARE service for maintaining the quality originally built into your WHIRLPOOL appliance.

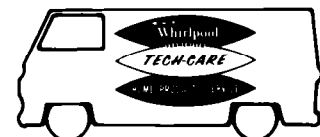

WHIRLPOOL CORPORATION BENTON HARBOR, MICHIGAN 49022