



Making Your World
A Little Easier.™

Use And Care

G U I D E

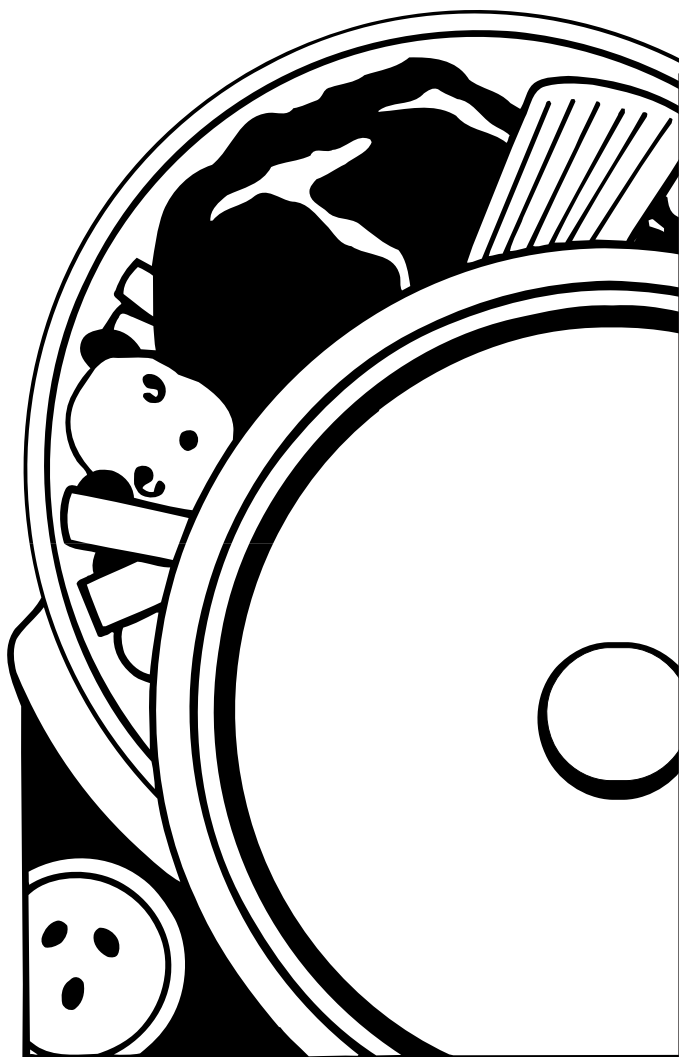

Table of Contents (complete)	2
A Note to You	3
Oven Safety	4-6
Getting to Know Your Oven	7
Using Your Oven	8
Using the Self- Cleaning Cycle	25
Caring for Your Oven	30
Troubleshooting	33
Requesting Assistance or Service	35
Index	39
Warranty	40

1-800-253-1301

Call us with questions or comments.

SELF-CLEANING GAS BUILT-IN OVEN

TO THE INSTALLER: PLEASE LEAVE THIS
INSTRUCTION BOOK WITH THE UNIT.

TO THE CONSUMER: PLEASE READ AND
KEEP THIS BOOK FOR FUTURE REFERENCE.

PART NO. 318103502 Rev. A/4372833

MODEL SB160PEE

Table of Contents

	Page		Page
A Note to You	3	Using the electronic MEALTIMER™ control	20
Oven Safety	4-6	The oven vents	24
Getting to Know Your Oven	7	The storage drawer	24
Using Your Oven	8	Using the Self-Cleaning Cycle	25
Positioning racks and pans	8	Before you start	25
For best air circulation	9	Before setting the controls	26
The electronic oven control	10	Setting the controls	26
Setting the clock	11	Special tips	28
Using the electronic Minute Timer	12	How the cycle works	29
Canceling a function	12	Caring for Your Oven	30
Baking with preheating	13	Cleaning chart	30
Baking/roasting without preheating	14	The oven light	32
Adjusting the oven temperature control	16	Troubleshooting	33
Broiling	17	Requesting Assistance or Service	35
Broiling tips	19	Index	39
Energy saving tips	19	Warranty	40

A Note to You

Thank you for buying a WHIRLPOOL® appliance.

Because your life is getting busier and more complicated, WHIRLPOOL ovens are easy to use, save time, and help you manage your home better. To ensure that you enjoy years of trouble-free operation, we developed this Use and Care Guide. It is full of valuable information about how to operate and maintain your appliance properly and safely. Please read it carefully.

Also, please complete and mail in the Ownership Registration Card provided with your appliance. The card helps us notify you about any new information on your appliance.

Please record your model's information.

Whenever you call to request service for your appliance, you need to know your complete model number and serial number. You can find this information on the model and serial number plate (see diagram on page 7 for location of plate).

Please also record the purchase date of your appliance and your dealer's name, address, and telephone number.

Model Number _____

Serial Number _____

Purchase Date _____

Dealer Name _____

Dealer Address _____

Dealer Phone _____

Keep this book and the sales slip together in a safe place for future reference.

**Our Consumer Assistance Center
number is toll-free.**

1-800-253-1301

Oven Safety

Your safety is important to us.

This guide contains safety statements under warning symbols. Please pay special attention to these symbols and follow any instructions given. Here is a brief explanation of the use of the symbol.



This symbol alerts you to hazards such as fire, electrical shock, or other injuries.

IMPORTANT SAFETY INSTRUCTIONS

READ AND SAVE THESE INSTRUCTIONS

Gas ovens have been thoroughly tested for safe and efficient operation. However, as with any appliance, there are specific installation and safety precautions which must be followed to ensure safe and satisfactory operation.

WARNING: If the information in this manual is not followed exactly, a fire or explosion may result causing property damage, personal injury or death.

- Do not store or use gasoline or other flammable vapors and liquids in the vicinity of this or any other appliance.
- WHAT TO DO IF YOU SMELL GAS:
 - Do not try to light any appliance.
 - Do not touch any electrical switch; do not use any phone in your building.
 - Immediately call your gas supplier from a neighbor's phone. Follow the gas supplier's instructions.
 - If you cannot reach your gas supplier, call the fire department.
- Installation and service must be performed by a qualified installer, service agency or the gas supplier.

General

- Install or locate the oven only in accordance with the provided Installation Instructions. The oven must be installed by a qualified installer. The oven must be properly connected to the proper gas supply and checked for leaks. The oven must also be properly connected to electrical supply and grounded.
- Gas fuels and their use in appliances can cause minor exposures to benzene, formaldehyde, carbon monoxide, and soot, primarily from incomplete combustion. Significant exposure to these substances could cause cancer or reproductive harm. Properly adjusted burners with a blue, rather than a yellow, flame will minimize incomplete combustion. Venting with a hood or an open window will further minimize exposure.
- Do not store things children might want above the oven. Children could be burned or injured while climbing on it.
- Do not leave children alone or unattended in area where the oven is in use. They should never be allowed to sit or stand on any part of the oven. They could be burned or injured.
- Do not operate the oven if it is damaged or not working properly.
- Do not use the oven for warming or heating the room. Persons could be burned or injured, or a fire could start.
- Do not attempt to light the oven burner during a power failure. Personal injury could result.
- Use the oven only for its intended use as described in this manual.



- Do not touch interior surfaces of oven. Areas near interior surfaces of an oven become hot enough to cause burns.

During and after use, do not touch, or let clothing or other flammable materials contact interior surfaces of oven until they have had sufficient time to cool. Other surfaces of the oven, such as the oven vent opening, the surface near the vent opening, and the oven door and window, could also become hot enough to cause burns.



- Do not wear loose or hanging garments when using the oven. They could ignite if they touch a hot surface and you could be burned.
- Use only dry pot holders. Moist or damp pot holders on hot surfaces could result in burns from steam. Do not use a towel or bulky cloth for a pot holder. It could catch on fire.
- Keep oven vents unobstructed.
- Do not heat unopened containers. They could explode. The hot contents could cause burns and container particles could cause injury.
- Use only cookware approved for oven use. Follow cookware manufacturer's instructions, especially when using glass or plastic cookware.
- Do not store flammable materials in or near the oven or in the storage drawer. The fumes could create an explosion and/or fire hazard.
- Do not use the oven for storage.
- Do not use aluminum foil to line oven bottom, or any other part of the oven. Use aluminum foil only as recommended in this manual.
- Never use a match or other flame to look for a gas leak. Explosion and injury could result.
- Know where your main gas shutoff valve is located.

When using the oven

- Always position the oven rack(s) in desired location while oven is cool.
- Use care when opening oven door. Let hot air or steam escape before removing or replacing food.



- Do not use water on grease fires. Never pick up a flaming pan. Smother flaming pan by covering with a well-fitting lid, cookie sheet, or flat tray. Flaming grease outside of pan can be extinguished with baking soda or, if available, a multipurpose dry chemical or foam-type extinguisher.

Grease

- Grease is flammable. Do not allow grease to collect in vents. Wipe spillovers immediately.

Care and cleaning

- Small amounts of formaldehyde and carbon monoxide are given off in the Self-Cleaning cycle from fiberglass insulation and food decomposition. Significant exposure to these substances could cause cancer or reproductive harm. Exposure can be minimized by venting with a hood or open window and wiping out excess food spills prior to self-cleaning.



- Do not use oven cleaners. No commercial oven cleaner or oven liner protective coating of any kind should be used in or around any part of the oven.
- Before self-cleaning the oven, remove broiler pan, broiler grid, oven racks, and other cookware. Do not use your oven to clean miscellaneous parts unless you are instructed to do so in this Use and Care Guide.
- Do not clean door heat seal. It is essential for a good seal. Care should be taken not to rub, damage, or move the seal. Clean only parts recommended in this Use and Care Guide.
- Do not repair or replace any part of the oven unless specifically recommended in this manual. All other servicing should be referred to a qualified technician.
- Any additions, changes, or conversions required in order for this appliance to satisfactorily meet the application needs must be made by a Whirlpool service company or Qualified Agency.
- Disconnect the electrical supply and the gas supply at the shutoff valve near the oven before servicing the oven.

– SAVE THESE INSTRUCTIONS –

Getting to Know Your Oven

This section contains captioned pictures of your oven. Use them to learn where all parts and features are and what they look like. Use the page references to help you quickly find out more about the part or feature you are interested in.

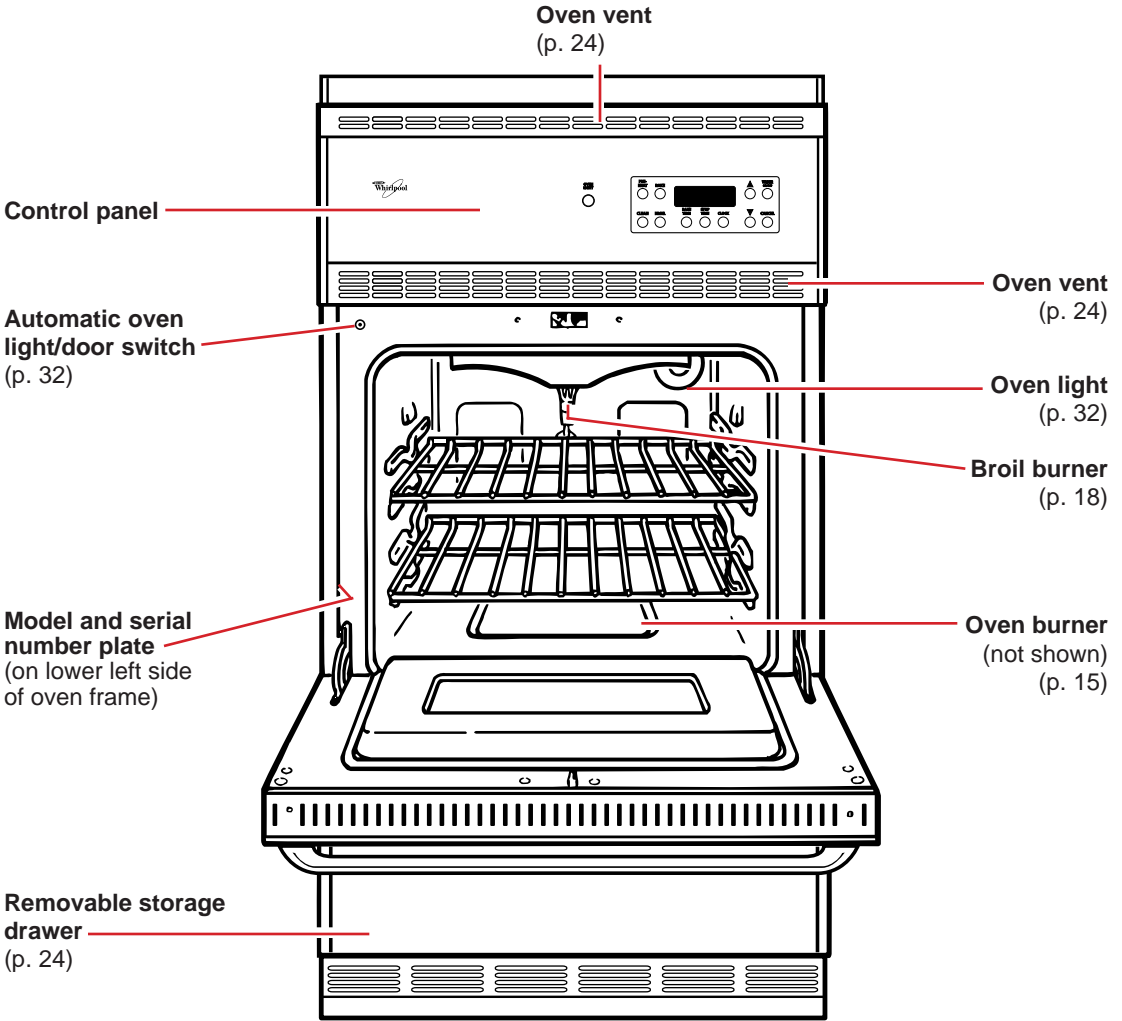

Control panel

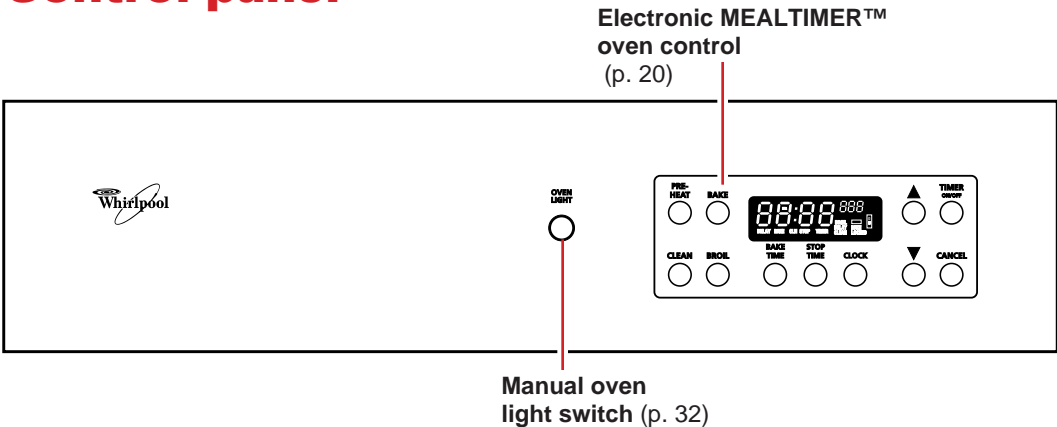

Using Your Oven

To get the best cooking results, you should use your oven the correct way. This section tells you what you need to know to use your oven safely and efficiently. This oven is equipped with an electronic ignitor for the oven burner and a second ignitor for the broil burner. The electronic ignitor automatically lights the oven burner each time it is used. This oven cannot be used during prolonged power failure.

NOTE: This oven was tested for use with natural gas and is also design approved for use with Liquefied Petroleum Propane gas. Instructions for conversions are in the Installation Instructions.

Positioning racks and pans

General guidelines

Follow this section carefully to get the best cooking results.

- Before turning on the oven, place oven racks where you need them.
- To remove a rack, pull it out to the stop. Lift the front of the rack and slide out. To replace the rack, fit it onto the guides on the oven walls. Tilt the front of the rack up and slide back into place.
- Be sure the rack(s) is level.
- Use pot holders or oven mitts to protect your hands if rack(s) must be moved while the oven is hot.
- When baking/roasting with 1 rack, place the rack so the top of the food will be centered in the oven.
- When baking/roasting on 2 racks, arrange the racks on the 2nd and 4th rack guides from the bottom.
- Do not place items on the oven door when it is open.

Using insulated bakeware, ovenproof glassware, and dark metal pans

- When baking with insulated cookie sheets or baking pans, place them in the bottom third of the oven. You may need to increase the recommended baking times, so test for doneness before removing from the oven.

- When using ovenproof glassware or dark bakeware, reduce the oven temperature by 25°F but use the same baking time. Because these pans absorb heat, producing darker bottom browning and crispier crusts, place the rack in the center of the oven. When baking pies and bread, you can use the temperature suggested in the recipe.

Rack placement for specific foods:

FOOD	RACK POSITION
Frozen pies, large roasts, turkeys, angel food cakes	1st or 2nd rack guide from bottom
Bundt cakes, most quick breads, yeast breads, casseroles, meats	2nd rack guide from bottom
Cookies, biscuits, muffins, cakes, nonfrozen pies	2nd or 3rd rack guide from bottom

NOTE: For information on where to place your rack when broiling, see “Broiling rack position chart” on page 19.

For best air circulation

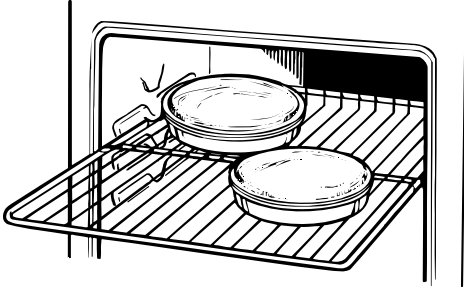

Hot air must circulate around the pans in the oven for even heat to reach all parts of the oven. This results in better baking.

- **Place** the pans so that one is not directly over the other.
- **For best results, allow** 1½-2 inches of space around each pan and between pans and oven walls.
- **Use** only one cookie sheet in the oven at a time.

Use the following as a guide to determine where to place the pans:

One pan

Place in the center of the oven rack.

Two pans

Place in opposite corners of the oven rack.

Three or four pans

Place in opposite corners on each oven rack. Stagger pans so no pan is directly over another.

The electronic oven control

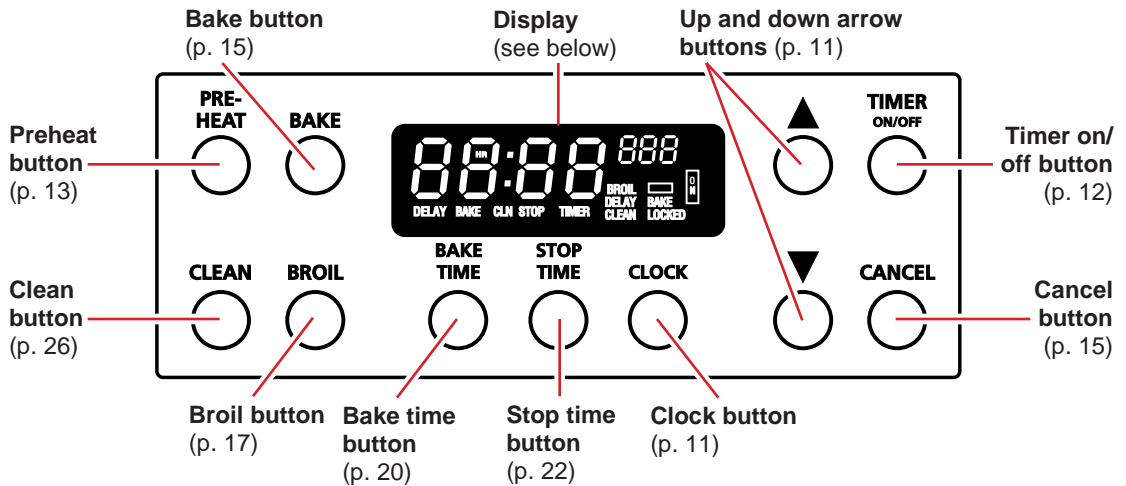

Display/clock

- **When you first plug in the oven**, the time display will flash until you set a new time. If, after you set the clock (page 11), the time display again flashes, your electricity was off for a while. Reset the clock.
- **When you are not using the oven**, the control is an accurate clock.
- **When you are using the oven or Minute Timer**, the display will show times, temperature settings, and what command buttons have been pressed.
- **When showing the time of day**, the display will show the hour and minutes.
- **When you are using the Minute Timer**, the display will show minutes and seconds in the following sequence:
 - **For settings from 5 seconds to 2 minutes**, the display will increase in 5-second amounts and count down each second.
 - **For settings from 2 minutes to 10 minutes**, the display will increase in 10-second amounts and count down each second.
 - **For settings from 10 minutes to 1 hour**, the display will increase in 1-minute amounts and count down each second.
 - **For settings from 1 hour to 9 hours 55 minutes**, the display will increase in 5-minute amounts and count down each minute.



- **When you are using Bake Time**, the display will show hours and minutes.

Command buttons

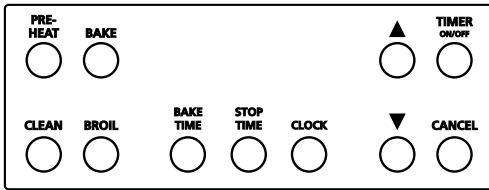

The command buttons tell the oven what to do and in what order. A few examples:

- **Clock** tells the oven you are going to set the clock.
- **Cancel** tells the oven to turn off.

Each command button (except Cancel) has its own Indicator Light on the display. The Indicator Light comes on when you press the command button.

Silent control panel

You will hear a tone each time you press a button. To program the oven for silent operation, press and hold the Stop Time button for 7 seconds. One tone will sound, indicating the program is complete. To hear tones again, press and hold the Stop Time button for 7 seconds or until you hear one tone.

Setting the clock

1. Press the Clock button.

PRESS

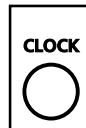

YOU SEE



2. Press and hold the Up or Down arrow button until the correct time shows on the large display.

PRESS AND HOLD



YOU SEE



(example shows 1 o'clock)

Using the electronic Minute Timer

The Minute Timer does not start or stop the oven. It works like a kitchen timer. It can be set in minutes and seconds up to 9 hours and 55 minutes.

1. Press the Timer On/Off button.

PRESS

YOU SEE

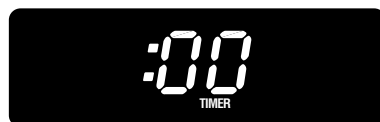
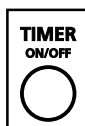

2. Press and hold the Up arrow button until the desired time shows on the large display.

The Minute Timer will begin counting down 2 seconds after the time is set. When time is up, you will hear 3 tones, then one reminder tone every 10 seconds for 5 minutes until you press the Timer On/Off button. To change the Minute Timer while it is in use, press and hold the Up or Down arrow button to increase or decrease time.

PRESS
AND HOLD

YOU SEE



(example shows 30 seconds)

To cancel the Minute Timer:

Press the Timer On/Off button.

PRESS

YOU SEE

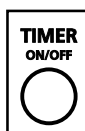

(time of day)

Canceling a function

The Cancel button will cancel any function except for times set with the Timer On/Off button. When the Cancel button is pressed, the large display will show the time of day or, if the Minute Timer is being used, the time remaining.



Baking with preheating

For best results when baking, preheat the oven before placing food in the oven. The oven can be programmed to preheat at any temperature from 170°F to 550°F. The preheat function will reduce preheating time.

NOTES:

- **Do not preheat** when roasting or cooking items such as casseroles.
- **Preheating** requires approximately 10 minutes. When the preheat temperature is reset higher, preheating will take an additional 10 minutes.
- **Do not attempt** to light the oven burner during a power failure. See “Important Safety Instructions” on page 5 for more information.

1. Position the rack(s) properly before turning on the oven.

For further information, see “Positioning racks and pans” on page 8.

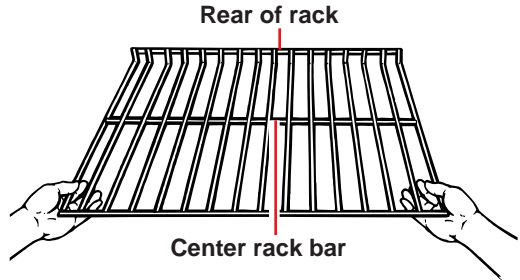

2. Press the Preheat button.

Proceed to the next operation within 5 seconds.

PRESS



YOU SEE

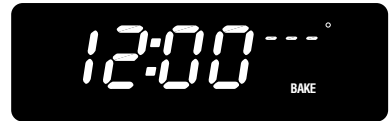

3. Press and hold the Up or Down arrow button until the desired temperature shows on the small display.

PRESS AND HOLD

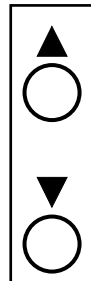

YOU SEE



(example shows 350°F baking temperature)

The burner will light in 50-60 seconds.

YOU SEE



USING YOUR OVEN

When the oven is finished preheating, one tone will sound and the small display will show the programmed set temperature.

YOU SEE



4. Put food in the oven.

The oven will automatically go from preheating into baking. You do not have to set a separate baking cycle. During baking, the oven burner will turn on and off to keep the oven temperature at the setting. The ON Indicator Light will cycle on and off with the burner.

NOTE: Do not place food directly on the oven bottom.

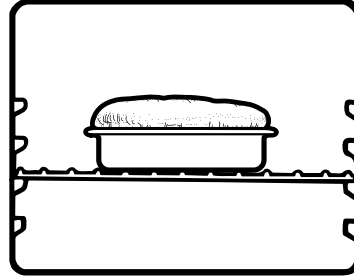

5. When baking is done, press the Cancel button.

The oven will then shut off.

PRESS



YOU SEE



(time of day)

Baking/roasting without preheating

NOTE: Do not attempt to light the oven burner during a power failure. See "Important Safety Instructions" on page 5 for more information.

1. Position the rack(s) properly before turning on the oven.

For further information, see "Positioning racks and pans" on page 8.

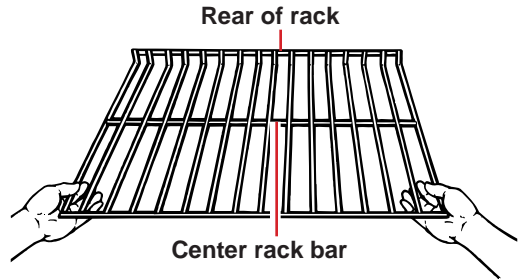

2. Press the Bake button.

PRESS



YOU SEE



3. Press and hold the Up or Down arrow button until the desired temperature shows on the small display.

The display will increase in 5°F amounts. The burner will light in 50-60 seconds.

NOTE: If the oven is still warm from an earlier use, the display will show the actual oven temperature and increase in 5°F amounts.

PRESS AND HOLD



YOU SEE



(example shows 350°F baking/roasting temperature)

4. Put food in the oven.

During baking/roasting, the oven burner will turn on and off to keep the oven temperature at the setting. The ON Indicator Light will cycle on and off with the burner.

NOTE: Do not place food directly on the oven bottom.

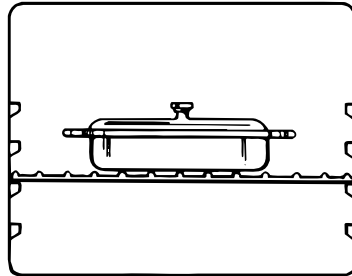

5. When baking/roasting is done, press the Cancel button.

The oven will then shut off.

PRESS



YOU SEE



(time of day)

Adjusting the oven temperature control

Although your new oven is properly adjusted to provide accurate temperatures, it may cook faster or slower than your old oven.

If, after using the oven for a period of time, you are not satisfied with the baking/roasting results, you can change the offset temperature by following these steps:

NOTES:

- **DO NOT measure** oven temperature with a thermometer. Opening the oven door will lower the oven temperature and give you an inaccurate reading. Also, the thermometer temperature reading will change as your oven cycles.
- **Adjusting** the oven temperature control will only change cooking temperatures. It will not affect Self-Cleaning temperatures.

1. Press and release the Bake button.

PRESS



YOU SEE



2. Press and hold the Up or Down arrow button until 550°F shows on the small display.

PRESS AND HOLD

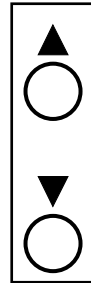

YOU SEE



3. Within two seconds, press and hold the Bake button until the special two-digit display appears. Release the Bake button.

The display now indicates the amount of degrees offset between the original factory temperature setting and the current temperature setting. If the oven control has the original factory setting, the display will read "00".

PRESS AND HOLD



YOU SEE



4. To change the setting, press and hold the Up or Down arrow button until the desired amount of offset appears on the display.

You can change the setting up or down 35°F, in 5°F amounts.

NOTE: If you have decreased the setting, a minus sign (-) will appear before the number. If you have increased the setting, there will not be any sign in front of the number.

PRESS AND HOLD **YOU SEE**

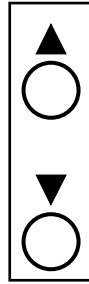

(example shows setting 10°F cooler)

5. Press the Cancel button.

PRESS **YOU SEE**



(time of day)

Broiling

1. Position the rack(s) before turning the oven on.

Position the oven rack so that the surface of the food is at least 3 inches away from the broil burner. See "Broiling rack position chart" on page 19.

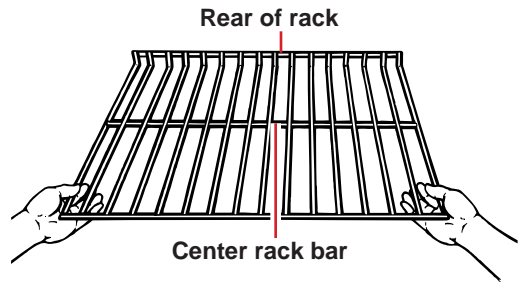

2. Preheat in BROIL for 5 minutes with the oven door closed.

NOTE: Do not preheat with the broiler pan in place.

PRESS **YOU SEE**

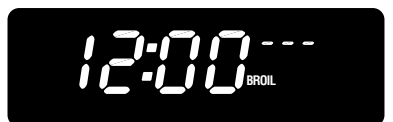
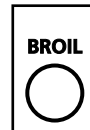

continued on next page

3. Press and hold the Up or Down arrow button to the setting you want.

When the oven turns on, the ON Indicator Light will come on. The burner lights automatically in 50-60 seconds. Preheat for 5 minutes.

You can broil at one of two settings – “LO” or “HI.” When the oven turns on, the ON Indicator Light will come on. The burner lights automatically in 50-60 seconds. Preheat for 5 minutes.

NOTE: For most foods, broil at “HI.” The “LO” setting can be used when broiling foods which overcook easily, such as fish, or meringues. The “LO” setting can also be used when broiling foods that are precooked.

PRESS AND HOLD **YOU SEE**

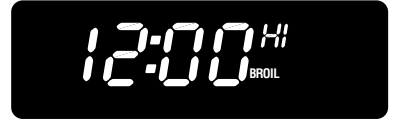
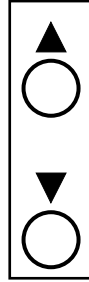

(example shows “HI” setting)

4. After preheating, put food on broiler pan grid and place in the center of the oven rack.

5. Completely close the oven door to ensure proper broiling temperatures.

Broil on one side until the food is browned; turn and cook on the second side. Season and serve.

NOTE: Always pull the rack out to the stop position before turning or removing food.

6. When broiling is done, press the Cancel button.

PRESS **YOU SEE**



(time of day)

Broiling tips

- **Use** the broiler pan and grid for broiling. They are designed to drain excess liquid and grease away from the cooking surface to help prevent spatter, smoke, or fire.
- **If you broil** small quantities, you may want to use a small broiler pan. They are available in the housewares section of many department stores.
- **Do not cover** the broiler grid with foil.
- **To make sure** the grease drains well, do not use cookie sheets or similar pans for broiling.
- **Place the food** about 3 inches or more from the broil burner.
- **For best broiling results**, preheat in BROIL for 5 minutes. Do not preheat with broiler pan in place.
- **Broiling rack position** determines how the burner cooks your food. The lower the position, the more broiler grid area covered. See “Broiling rack position chart” below for more information.
- **To sear meat**, place broiler pan at one of the higher rack positions so that meat is very near the flame.
- **Thin ($\frac{3}{4}$ ") steaks** may be broiled in the higher rack positions.
- **To cook thick ($1\frac{1}{2}$ ") steaks** and other thick cuts of meat well done, move them to a lower rack position after searing.
- **After broiling**, remove the broiler pan from the oven when you remove the food. Drippings will bake on the pan if you leave it in the heated oven.

Broiling rack position chart

RACK POSITION FROM BOTTOM	FOOD
1	Well-done foods such as chicken and lobster
2	Ham slices, fish, medium steaks, hamburgers, and chops
3 or 4	Rare steaks

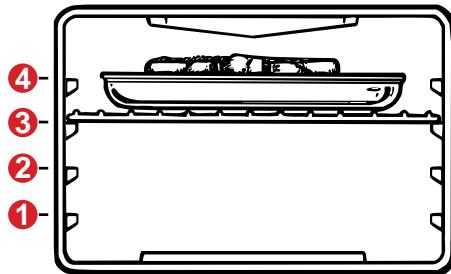

Energy saving tips

Although the energy used for cooking is usually a very small percentage of the total energy used in the home, cooking energy can be used efficiently. Here are some tips to help you save energy when using your cooking product:

- **Use** pans with flat bottoms, straight sides, and tight-fitting lids.
- **Cook** with a minimum of liquid or fat to help shorten cooking time.
- **Preheat** oven only when recommended and for the shortest time possible.
- **“Oven peeking”** may cause heat loss, longer cooking times, and unsatisfactory baking results. Rely on your timer to keep track of the cooking time.
- **Bake** cakes, pies, or cookies when oven is warm. Best time to bake is right after a meal has been cooked in the oven.
- **Plan** your meals for the most efficient use of the oven. When using the oven to cook one food, try to cook the rest of the meal in it also.
- **Do not preheat** when roasting or cooking items such as casseroles.

Using the electronic MEALTIMER™ control

The electronic MEALTIMER control will turn the oven on and off at times you set, even when you are not around.

Delayed time baking/roasting is ideal for foods which do not require a preheated oven, such as meats and casseroles. **Do not use delayed time cooking for cakes, cookies, etc. – they will not rise properly.**

Before using the electronic MEALTIMER control, make sure the clock is set to the correct time of day. (See “Setting the clock” on page 11.)

! WARNING

Food Poisoning Hazard

Do not let food sit in oven more than one hour before or after cooking.

Doing so can result in death, food poisoning, or sickness.

To start baking/roasting now and stop automatically

1. Position the oven rack(s) properly and put food in the oven.

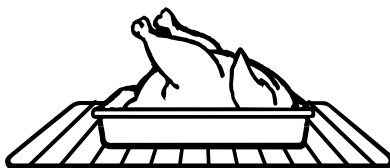

2. Press the Bake Time button.

PRESS



YOU SEE

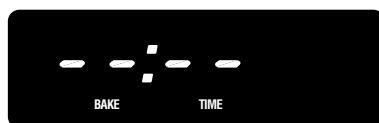

3. Press and hold the Up arrow button until the desired baking/roasting time, up to 11 hours 59 minutes, shows on the large display.

PRESS AND HOLD



YOU SEE



(example shows 30 minutes baking/roasting time)

4. Press the Bake button to set the desired temperature.

PRESS



YOU SEE

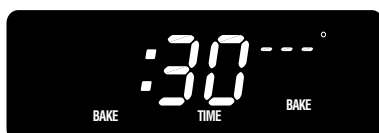

5. Press and hold the Up or Down arrow button until the desired baking/roasting temperature shows on the small display.

The display will count down in 1-minute amounts.

NOTE: When the oven starts heating, the display will show the actual oven temperature. The displayed temperature will increase in 5°F amounts until the set temperature is reached.

PRESS AND HOLD **YOU SEE**

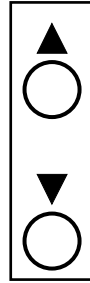

(example shows 350°F baking/roasting temperature)

6. When baking/roasting time is completed, the oven will turn off automatically and three tones will sound.

One tone will sound every 10 seconds for 5 minutes or until you press the Cancel button.

PRESS **YOU SEE**



(time of day)

To delay start and stop automatically

1. Position the oven rack(s) properly and put food in the oven.

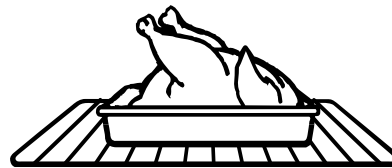

2. Press the Bake Time button.

PRESS **YOU SEE**

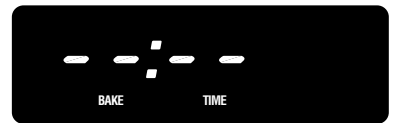

continued on next page

USING YOUR OVEN

3. Press and hold the Up arrow button until the desired baking/roasting time, up to 11 hours 59 minutes, shows on the large display.

**PRESS
AND HOLD**



YOU SEE



(example shows 30-minute baking/roasting time)

4. Press the Stop Time button.

PRESS



YOU SEE



5. Press and hold the Up or Down arrow button until the desired stop time shows on the large display.

The display will then show the baking/roasting time and one tone will sound. If you do not set a baking/roasting temperature within 15 seconds, the control will cancel.

Cooking will start at a time equal to the stop time minus the baking/roasting time. In example shown, that would be 5:30 minus 30 minutes, or 5 o'clock.

**PRESS
AND HOLD**



YOU SEE

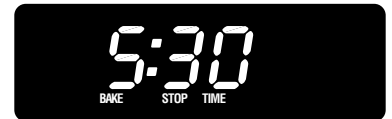

(example shows 5:30 stop time)

YOU SEE



(display returns to baking/roasting time)

6. Press the Bake button.

PRESS



YOU SEE

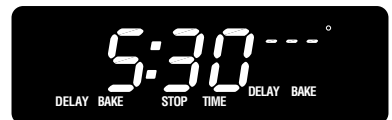

(display shows stop time)

7. Press and hold the Up or Down arrow button to set the desired baking/roasting temperature.

NOTE: Changes can be made at any time by pressing a command button.

PRESS AND HOLD

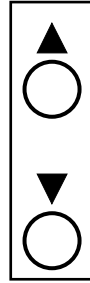

YOU SEE



(example shows 350°F baking/roasting temperature)

8. When the start time is reached:

NOTE: When the oven starts heating, the display will show the actual oven temperature. The displayed temperature will increase in 5°F amounts until the set temperature is reached.

YOU SEE

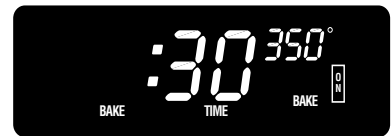

(display counts down set time)

9. When baking/roasting time is completed, the oven will turn off automatically and three tones will sound.

One tone will sound every 10 seconds for 5 minutes or until you press the Cancel button.

YOU SEE



(time of day)

To cancel the MEALTIMER™ control settings:

Press the Cancel button.

PRESS



YOU SEE



(time of day)

The oven vents

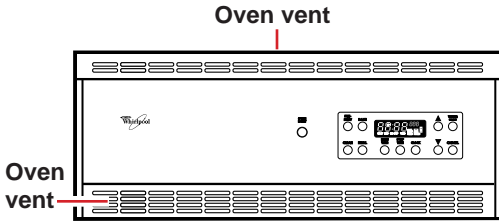

Hot air and moisture escape from the oven through vents located above and below the control panel. The vents are needed for air circulation.

The storage drawer

You can remove the storage drawer to make it easier to clean under the oven. **Use care when handling the drawer.**

Removing the storage drawer:

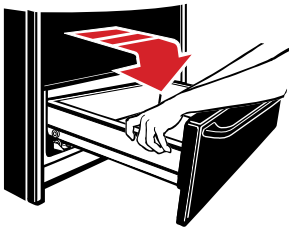

1. **Open** the storage drawer to the stop position.
2. **Tilt** drawer upward and **continue to pull** drawer out until drawer rollers are against the rail rollers.
3. **Tilt** drawer down and **continue to pull** drawer out of rails on both sides of opening.
4. **Set** drawer aside on a protected surface.

Replacing the storage drawer:

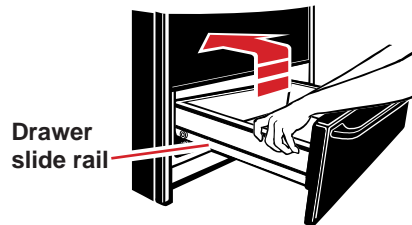

1. **Grasp** front of storage drawer and **place** rollers on drawer behind rollers in rails on both sides of opening.
2. **Close** drawer until it hits the stop, then **tilt** drawer upward to clear the stop.
3. **Close** drawer.

Using the Self-Cleaning Cycle

The Self-Cleaning cycle saves you from the toil and mess that often come with hand-cleaning the oven interior. Like the other functions of your oven, you operate the Self-Cleaning cycle with the easy-to-use controls. Please review the instructions in this section to keep your oven spotless.

	<h2 style="text-align: center;">! WARNING</h2> <p style="text-align: center;">Burn Hazard</p> <p>Do not touch the oven during the Self-Cleaning cycle.</p> <p>Keep children away from oven during Self-Cleaning cycle.</p> <p>Do not use commercial oven cleaners in your oven.</p> <p>Failure to follow these instructions can result in burns, or illness from inhaling dangerous fumes.</p>
---	---

Before you start

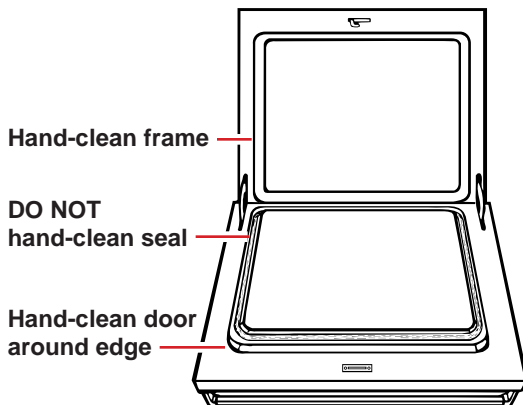

Before you start the Self-Cleaning cycle, make sure you:

- **Hand-clean the areas shown.** They do not get hot enough during the cleaning cycle for soil to burn away. Use hot water and detergent or a soapy steel-wool pad for cleaning.

NOTE: DO NOT clean, move, or bend the seal. Poor cleaning, baking, and roasting may result.

- **Remove the broiler pan and grid** and any pots and pans being stored in the oven.

- **Wipe up food spills** containing sugar as soon as possible after the oven cools down. When sugar is heated to a high temperature in the Self-Cleaning cycle, the high temperature can cause the sugar to burn and react with the porcelain. This can cause staining and etching or pitting.
- **Wipe out any loose soil or grease.** This will help reduce smoke during the Self-Cleaning cycle.
- **Remove the oven racks from the oven if you want them to remain shiny.** You can clean the oven racks in the Self-Cleaning cycle, but they will become harder to slide. (See page 31.) If you clean racks in the Self-Cleaning cycle, place them on the 2nd and 4th rack guides. (Guides are counted from bottom to top.)
- **Heat and odors** are normal during the Self-Cleaning cycle. Keep the kitchen well ventilated by opening a window or by turning on a vent hood or other kitchen vent during the cycle.

continued on next page

USING THE SELF-CLEANING CYCLE

TIPS:

- **Do not force** the door lock. You could bend or break it. The door lock is designed to stay locked until the oven is cool enough to safely open. Wait until it opens.
- **Do not block** the vent during the Self-Cleaning cycle. Air must move freely for best cleaning results.
- **Do not leave** plastic utensils near the vent. They may melt.
- **Do not leave** any foil in the oven during the Self-Cleaning cycle. Foil could burn or melt and damage the oven surface.
- **Make sure** the oven light is off during the Self-Cleaning cycle. Keeping the oven light on will shorten bulb life.
- **This oven** is equipped with an internal cooling fan. You will hear a fan sound during a normal Self-Cleaning cycle. This fan comes on automatically to keep the electronic controls cool. Canceling the oven will not turn off this fan. It will continue running until the electronic controls have cooled enough. The fan will then automatically turn off.

Before setting the controls

Make sure the clock is set to the correct time of day and the door is closed.

(See “Setting the clock” on page 11.)

Setting the controls

To start cleaning immediately:

Press the Clean button and press and hold the Up or Down arrow button until the desired cleaning time shows on the display.

- Use 2 hours for light soil.
- Use 3 hours to 4 hours maximum for moderate to heavy soil.

PRESS



PRESS AND HOLD **YOU SEE**



(example shows 3-hour cleaning time)

When the Self-Cleaning temperature is reached:

The Clean and Oven Indicator Lights will come on to tell you cleaning has begun.

To delay the start:

1. Press the Clean button and press and hold the Up or Down arrow button until the desired cleaning time shows on the display.

- Use 2 hours for light soil.
- Use 3 hours to 4 hours maximum for moderate to heavy soil.

PRESS



PRESS AND HOLD

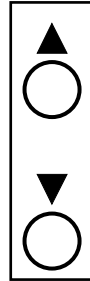

YOU SEE



(example shows 3-hour cleaning time)

2. Immediately press the Stop Time button and press and hold the Up or Down arrow button to the new stop time.

The Self-Cleaning cycle will start at a time equal to the stop time minus the cleaning time. In the example at the right, that would be 5:30 minus three hours, or 2:30.

PRESS

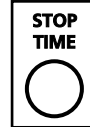

PRESS AND HOLD

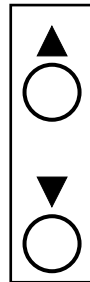

YOU SEE



(example shows 5:30 stop time)

After the Self-Cleaning cycle is set:

The LOCKED Indicator Light will come on 15 seconds after you set the cleaning time. The door cannot be opened when this Indicator Light is on.

When the Self-Cleaning temperature is reached:

The Clean and Oven Indicator Lights will come on to tell you cleaning has begun.

After the Self-Cleaning cycle is completed:

YOU SEE



(time of day)

When the oven reaches HI broil temperatures:

The LOCKED Indicator Light will go off when the cooling time is over (after 30 minutes or more). The door lock will release 12-15 seconds after the LOCKED Indicator Light goes off. You can then open the door.

NOTE: If the door is opened too soon after the LOCKED Indicator Light goes off, the control will no longer work correctly. If this happens, close the door for an extra 10 seconds to fully release the door lock. The control will now work normally.

YOU SEE

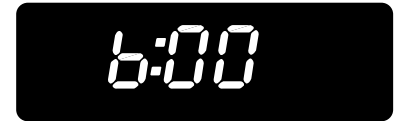

(time of day)

To stop the Self-Cleaning cycle at any time:

Press the Cancel button. When the LOCKED Indicator Light goes off, you can open the door.

PRESS



YOU SEE



(time of day)

Special tips

- **Keep** the kitchen well ventilated during the Self-Cleaning cycle to help get rid of heat, odors, and smoke.
- **After the oven is cool**, wipe up any residue or ash with a damp cloth or sponge. If any spots remain, clean with a mild abrasive cleanser or cleaning sponge.
- **Clean** the oven before it gets heavily soiled. Cleaning a very soiled oven takes longer and results in more smoke than usual.
- **If the Self-Cleaning cycle does not get the oven as clean as you expected**, the cycle may not have been set long enough or you may not have prepared the oven properly. Set the Self-Cleaning cycle longer the next time and hand-clean areas noted on page 25.

How the cycle works

The Self-Cleaning cycle uses very high heat to burn away soil and grease. During the cycle, the oven gets much hotter than it does for normal baking or broiling. This high heat breaks up the soil or grease and burns it away.

We recommend a 3-hour Self-Cleaning cycle. However, you can adjust the cycle time to the amount of soil in your oven. You can set the cycle anywhere between 2 and 4 hours. (See “Setting the controls” on page 26.)

The graph at the right is representative of a normal, 3-hour Self-Cleaning cycle. Note that the heating stops when the 3-hour setting is up, but it takes longer for the oven to cool enough to unlock.

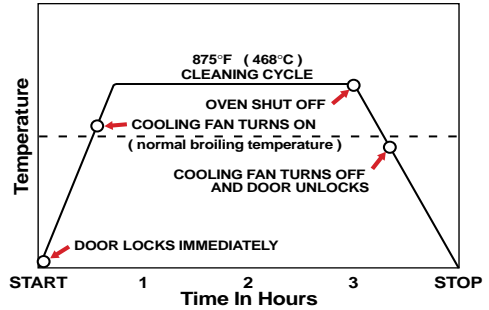

Caring for Your Oven

Your oven is designed for easy care. You can do most cleaning with items found around your home. Cleaning your oven whenever spills or soiling occurs will help to keep it looking and operating like new.



! WARNING

Explosion Hazard

Do not store flammable materials such as gasoline near this appliance.

Doing so can result in death, explosion, fire, or burns.

Cleaning chart

Use the following table to help you clean your oven.

PART	WHAT TO USE	HOW TO CLEAN
Control panel and other exterior surfaces	Sponge and warm, soapy water OR Paper towel and spray glass cleaner	<ul style="list-style-type: none">• Wash, wipe with clean water, and dry thoroughly.• Do not use steel wool or abrasive cleansers. They may damage the finish.• Do not spray cleaner directly on panel. Apply cleaner to paper towel. <p>NOTE: Make sure you have not turned the oven on when cleaning the panel. If you have, press the Cancel button.</p>
Broiler pan and grid (clean after each use)	Steel-wool pad and warm, soapy water	<ul style="list-style-type: none">• Wash, rinse, and dry thoroughly.• Do not clean the pan and grid in the Self-Cleaning cycle.

PART	WHAT TO USE	HOW TO CLEAN
Oven racks	Steel-wool pad and warm, soapy water OR The Self-Cleaning cycle	<ul style="list-style-type: none"> • Wash, rinse, and dry thoroughly. <p>OR</p> <ul style="list-style-type: none"> • Leave in oven during Self-Cleaning cycle. <p>NOTE: Racks will permanently discolor and become harder to slide if left in oven during Self-Cleaning cycle. Apply a small amount of vegetable oil to the side rungs to aid sliding.</p>
Oven door glass	Paper towel and spray glass cleaner OR Warm, soapy water and a nonabrasive, plastic scrubbing pad	<ul style="list-style-type: none"> • Make sure oven is cool. • Follow directions provided with the cleaner. • Wash, wipe with clean water, and dry thoroughly.
Oven cavity	Self-Cleaning cycle	<ul style="list-style-type: none"> • See “Using the Self-Cleaning Cycle” on pages 25-28.

The oven light

The Oven Light will come on when you open the oven door. To turn the light on when the oven door is closed, push the Oven Light Switch on the control panel. Push the switch again to turn off the light.

To replace the oven light:

1. **Unplug** appliance or **disconnect** at the main power supply.

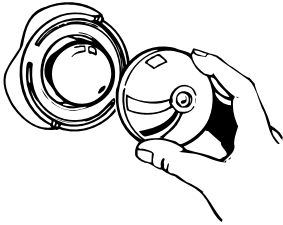

2. **Remove** the glass bulb cover in the back of the oven by pushing the wire holder to the side and pulling out the glass cover.
3. **Remove** the light bulb from its socket. **Replace** with a 40-watt appliance bulb.

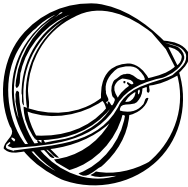

4. **Replace** the bulb cover and **snap** the wire holder in place. **Plug in** appliance or **reconnect** at the main power supply.

NOTE: Make sure the oven light is off during the Self-Cleaning cycle. Keeping the oven light on will shorten bulb life.

Troubleshooting

Most cooking problems often are caused by little things you can find and fix without tools of any kind. Check the lists below and on the next page before calling for assistance or service. If you still need help, see “Requesting Assistance or Service” on page 35.

If nothing operates, check the following:

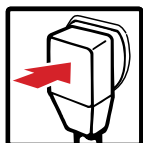

Is the oven plugged into a live outlet with the proper voltage? (See Installation Instructions.)



Have you blown a household fuse or tripped a circuit breaker?

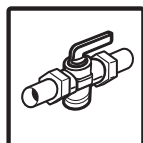

Is the oven properly connected to gas supply? Contact an authorized Whirlpool service company to reconnect oven to gas supply. (See Installation Instructions.)



Is the flow of combustion and/or ventilation air to the oven blocked?

Other possible problems and their causes:

PROBLEM	CAUSE
The oven will not operate	<ul style="list-style-type: none"> You have not set the electronic control correctly. Refer to the section in this manual describing the function you are operating. You have programmed a delayed start time. Wait for the start time to be reached or cancel and reset the control. The oven door is not closed.
Burner fails to light	<ul style="list-style-type: none"> The oven is not wired into a live circuit with the proper voltage. (See Installation Instructions.) You have blown a household fuse or tripped a circuit breaker. The gas supply shutoff valve(s) is closed.
The Self-Cleaning cycle will not operate	<ul style="list-style-type: none"> The clock does not show the correct time of day. (See page 11 for setting information.) You have programmed a delayed start time. Wait for the start time to be reached or cancel and reset the control.

TROUBLESHOOTING

PROBLEM	CAUSE
The cooling fan does not shut off after the Self-Cleaning cycle is completed	<ul style="list-style-type: none">• The electronic controls have not cooled enough. The fan will only shut off after electronic controls have cooled. Canceling the Self-Cleaning cycle will not turn off the cooling fan.
Cooking results are not what you expected	<ul style="list-style-type: none">• The oven is not level. (See Installation Instructions.)• The oven temperature seems too low or too high. See “Adjusting the oven temperature control” on page 16 to adjust oven temperature.• You did not preheat the oven before baking (if called for in recipe).• The recipe you are using may need to be altered to improve the taste or appearance of the food.• You are using a pan that is not the correct type or size. Refer to a reliable cookbook or recipe for recommended pan type and size.• There is not enough air space around pan when baking. Allow 1½ to 2 inches of air space on all sides of pan.• If broiling, you have not completely closed the oven door. The broiler provides the best cooking results with the oven door closed.
A tone sounds and the display shows F1 or F3	<ul style="list-style-type: none">• The electronic control has detected a fault condition. Press the Cancel button to clear the display and stop the tones, then attempt to reprogram the oven. If the fault recurs, record the fault number shown on the display, press the Cancel button and contact an authorized servicer.

If none of these items was causing your problem, see “Requesting Assistance or Service” on page 35.

Requesting Assistance or Service

Before calling for assistance or service, please check “Troubleshooting” on pages 33-34. It may save you the cost of a service call. If you still need help, follow the instructions below.

1. If you need assistance* ...

Call Whirlpool Consumer Assistance



**Center telephone number.
Dial toll-free from anywhere
in the U.S.A.:**

1-800-253-1301

and talk with one of our trained consultants. The consultant can instruct you in how to obtain satisfactory operation from your appliance or, if service is necessary, recommend a qualified service company in your area.

If you prefer, write to:

Whirlpool Brand Home Appliances
Consumer Assistance Center
c/o Correspondence Department
2000 North M-63
Benton Harbor, MI 49022-2692

Please include a daytime phone number in your correspondence.

2. If you need service* ...

Whirlpool has a nationwide network of authorized Whirlpool service companies. Whirlpool service technicians are trained to fulfill the product warranty and provide after-warranty service, anywhere in the United States. To locate the authorized Whirlpool service company in your area, call our Consumer Assistance Center telephone number (see Step 1) or look in your telephone directory Yellow Pages under:



**•APPLIANCE-HOUSEHOLD-
MAJOR, SERVICE & REPAIR**

- See: Whirlpool Appliances or
Authorized Whirlpool Service
(Example: XYZ Service Co.)

**•WASHING MACHINES &
DRYERS, SERVICE & REPAIR**

- See: Whirlpool Appliances or
Authorized Whirlpool Service
(Example: XYZ Service Co.)

3. If you need FSP® replacement parts ...

FSP is a registered trademark of Whirlpool Corporation for quality parts. Look for this symbol of quality whenever you need a replacement part for your Whirlpool® appliance. FSP replacement parts will fit right and work right, because they are made to the same exacting specifications used to build every new Whirlpool appliance.

To locate FSP replacement parts in your area, refer to Step 2 or call the Whirlpool Consumer Assistance Center number in Step 1.

4. If you are not satisfied with how the problem was solved ...

- Contact the Major Appliance Consumer Action Program (MACAP). MACAP is a group of independent consumer experts that voices consumer views at the highest levels of the major appliance industry.
- Contact MACAP only when the dealer, authorized servicer, and Whirlpool have failed to resolve your problem.

Major Appliance Consumer Action Program
20 North Wacker Drive
Chicago, IL 60606

- MACAP will in turn inform us of your action.

* When asking for help or service:

Please provide a detailed description of the problem, your appliance's complete model and serial numbers, and the purchase date. (See page 3.) This information will help us respond properly to your request.

Index

This index is alphabetical. It contains all the topics included in this manual, along with the page(s) on which you can find each topic.

TOPIC	PAGE	TOPIC	PAGE
ASSISTANCE	35	MODEL AND SERIAL NUMBER	3
BAKING		OVEN TEMPERATURE	
Aluminum foil	5	Adjusting	16
Pans	8, 9	Setting	13, 15, 16, 20, 22
Racks	8	OVEN VENTS	24
Setting cycle	13, 14	PANS	8, 9
BROILING		PARTS	7
Broiling rack position chart	19	POWER FAILURE	5
Grid	18	PREHEATING	13
Pan	18, 19	RACKS	8
Setting cycle	17	ROASTING	
Tips	19	Pans	8, 9
CLEANING		Racks	8
Broiler pan and grid	30	Setting cycle	13, 14
Control panel	30	SAFETY	4-6
Exterior surfaces	30	SELF-CLEANING	
Oven cavity	31	After cycle is completed	28
Oven door glass	31	After cycle starts	27
Oven racks	31	Delaying the start	27
CLOCK	11	How cycle works	29
ELECTRONIC OVEN CONTROL		Preparing oven	25, 26
Canceling	12	Setting controls	26
Clock	11	Starting immediately	26
Command buttons	11	Stopping cycle	28
Display	10	Tips	28
Minute timer	12	When oven reaches HI broil temperatures	28
Up/Down button	11	SERVICE	35
ENERGY SAVING TIPS	19	STORAGE DRAWER	
FEATURES	7	Removing	24
LIGHT	32	Replacing	24
MEALTIMER™ CONTROL	20	TROUBLESHOOTING	33
Canceling	23	WARRANTY	40
Delaying start and stopping automatically	21		
Starting now and stopping automatically	20		
MINUTE TIMER	12		

WHIRLPOOL®

Gas Built-In Oven Warranty

LENGTH OF WARRANTY	WHIRLPOOL WILL PAY FOR
FULL ONE-YEAR WARRANTY FROM DATE OF PURCHASE	FSP® replacement parts and repair labor to correct defects in materials or workmanship. Service must be provided by an authorized Whirlpool service company.
WHIRLPOOL WILL NOT PAY FOR	
<p>A. Service calls to:</p> <ol style="list-style-type: none"> 1. Correct the installation of your built-in oven. 2. Instruct you how to use your built-in oven. 3. Replace house fuses or correct house wiring or plumbing. 4. Replace owner accessible light bulbs. <p>B. Repairs when your built-in oven is used in other than normal, single-family household use.</p> <p>C. Pickup and delivery. Your built-in oven is designed to be repaired in the home.</p> <p>D. Damage to your built-in oven caused by accident, misuse, fire, flood, acts of God, or use of products not approved by Whirlpool.</p> <p>E. Repairs to parts or systems caused by unauthorized modifications made to the appliance.</p>	

2/96

WHIRLPOOL CORPORATION SHALL NOT BE LIABLE FOR INCIDENTAL OR CONSEQUENTIAL DAMAGES. Some states do not allow the exclusion or limitation of incidental or consequential damages, so this exclusion or limitation may not apply to you. This warranty gives you specific legal rights, and you may also have other rights which vary from state to state.

Outside the United States, a different warranty may apply. For details, please contact your authorized Whirlpool dealer.

If you need service, first see the “Troubleshooting” section of this book. After checking “Troubleshooting,” additional help can be found by checking the “Requesting Assistance or Service” section or by calling our Consumer Assistance Center telephone number, **1-800-253-1301**, from anywhere in the U.S.A.