

# Use & Care Manual

*Top Mount*

## Refrigerator

**Got Questions?  
Need Parts or Service?**



**Before Calling Your  
Local Repair Service - CALL:**

 **Electrolux  
Solutions Hotline**

**(United States)**

**1-800-944-9044**

**(Canada)**

**1-800-668-4606**

- ✓ Resolve many service issues over the phone at your convenience!
- ✓ If we can't resolve your service issue, we'll schedule a reputable local service technician for you!
- ✓ Order Genuine Electrolux Parts & Accessories
- ✓ Purchase Extended Warranty Protection

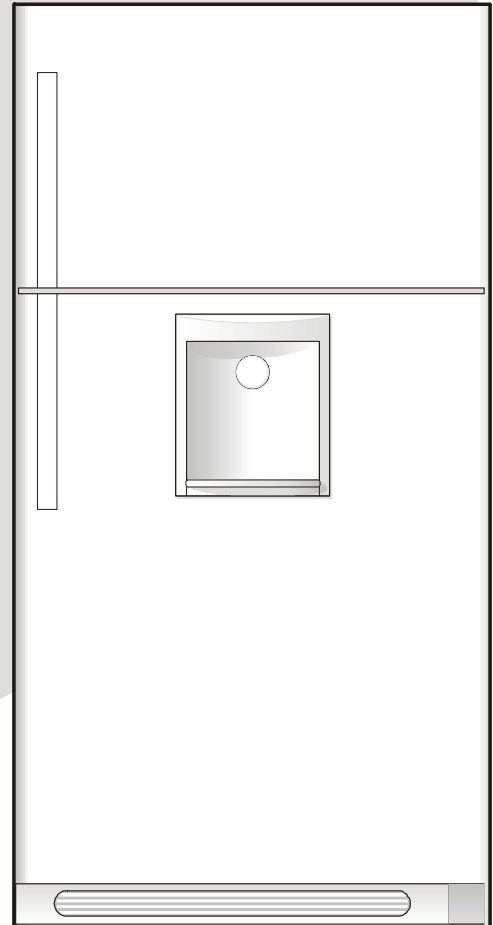

Important Safety Instructions .....	2
Installation .....	3
Connecting Water Supply .....	4
Door Removal .....	5
Temperature Controls .....	6
Water Dispenser & Ice Service .....	7
Normal Operating Sounds & Sights .	8
Care and Cleaning .....	11
Warranty .....	12
Before you Call .....	13



## IMPORTANT SAFETY INSTRUCTIONS

### **WARNING**

Please Read All Instructions Before Using This Refrigerator.

#### FOR YOUR SAFETY

- Do not store or use gasoline, or other flammable liquids in the vicinity of this or any other appliance. Read product labels for warnings regarding flammability and other hazards.
- Do not operate the refrigerator in the presence of explosive fumes.
- Avoid contact with any moving parts of automatic ice maker.
- Remove all staples from the carton. Staples can cause severe cuts, and also destroy finishes if they come in contact with other appliances or furniture.

#### CHILD SAFETY

Destroy or recycle the carton, plastic bags, and any exterior wrapping material immediately after the refrigerator is unpacked. Children should **NEVER** use these items to play. Cartons covered with rugs, bedspreads, plastic sheets or stretch wrap may become airtight chambers, and can quickly cause suffocation.

### **WARNING**

These Guidelines Must Be Followed To Ensure That Safety Mechanisms In This Refrigerator Will Operate Properly.

#### ELECTRICAL INFORMATION

- **The refrigerator must be plugged into its own dedicated 115 Volt, 60 Hz., AC only electric outlet.** The power cord of the appliance is equipped with a three-prong grounding plug for your protection against electrical shock hazards. It must be plugged directly into a properly grounded three-prong receptacle. The receptacle must be installed in accordance with local codes and ordinances. Consult a qualified electrician. **Do not use an extension cord or adapter plug.**
- If the power cord is damaged, it should be replaced by the manufacturer, service technician or a qualified person to prevent any risk.
- Never unplug the refrigerator by pulling on the power cord. Always grip the plug firmly, and pull straight out from the receptacle to prevent damaging the power cord.
- Unplug the refrigerator before cleaning and before replacing a light bulb to avoid electrical shock.
- Performance may be affected if the voltage varies by 10% or more. Operating the refrigerator with insufficient power can damage the compressor. Such damage is not covered under your warranty.
- Do not plug the unit into an outlet controlled by a wall switch or pull cord to prevent the refrigerator from being turned off accidentally.
- Avoid connecting refrigerator to a Ground Fault Interruptor (GFI) circuit.

#### PROPER DISPOSAL OF YOUR REFRIGERATOR OR FREEZER

##### Risk of child entrapment

Child entrapment and suffocation are not problems of the past. Junked or abandoned refrigerators or freezers are still dangerous – even if they will sit for “just a few days.” If you are getting rid of your old refrigerator or freezer, please follow the instructions below to help prevent accidents.

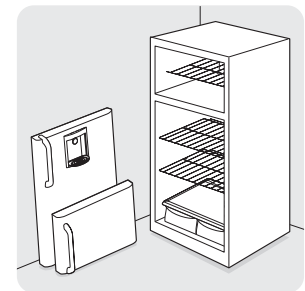

##### Before you throw away your old refrigerator/ freezer:

- Remove doors.
- Leave shelves in place so children may not easily climb inside.
- Have refrigerant removed by a qualified service technician.

#### IMPORTANT

Turning the Freezer and Fresh Food Controls to “0” turns off the compressor and prevents your refrigerator from cooling, but does not disconnect the power to the light bulb and other electrical components. To turn off power to your refrigerator you must unplug the power cord from the wall outlet.

Grounding type wall receptacle



Do not, under any circumstances, cut, remove, or bypass the grounding prong.

Power cord with 3-prong grounded plug

### **CAUTION**

To avoid personal injury or property damage, handle tempered glass shelves carefully. Shelves may break suddenly if nicked, scratched, or exposed to sudden temperature change.



# INSTALLATION

This Use & Care Manual provides specific operating instructions for your model. Use the refrigerator only as instructed in this Use & Care Manual. **Before starting the refrigerator, follow these important first steps.**

## LOCATION

- Choose a place that is near a grounded electrical outlet. **Do Not** use an extension cord or an adapter plug.
- If possible, place the refrigerator out of direct sunlight and away from the range, dishwasher or other heat sources.
- The refrigerator must be installed on a floor that is level and strong enough to support a fully loaded refrigerator.
- Consider water supply availability for models equipped with an automatic ice maker.

## INSTALLATION

### CAUTION

**Do Not install the refrigerator where the temperature will drop below 55°F (13°C) or rise above 110°F (43°C). The compressor will not be able to maintain proper temperatures inside the refrigerator.**

**Do Not block the toe grille on the lower front of your refrigerator. Sufficient air circulation is essential for the proper operation of your refrigerator.**

### IMPORTANT

If you install your refrigerator in a garage or other unheated area, you may experience freezer temperature problems during the winter months when temperatures dip below 55° F.

Upgrading your refrigerator with a Garage Kit will lower the minimum operating temperature of your unit to 34° F. This kit can be ordered through the *Electrolux Solutions Hotline* (see back cover).

## Installation Clearances

- Allow the following clearances for ease of installation, proper air circulation, and plumbing and electrical connections:

Sides & Top	3/8"
Back	1"

### NOTE

If you see black coils/tubing on the back of your refrigerator (air-cooled condenser) leave 3" clearance at top of refrigerator.

## DOOR OPENING

Your refrigerator should be positioned to allow easy access to a counter when removing food.

### NOTE

If your refrigerator is placed with the door hinge side against a wall, you may have to allow additional space so the door can be opened wider.

## LEVELING

All four corners of your refrigerator must rest firmly on a solid floor. Your refrigerator is equipped with adjustable front rollers or front leveling screws to help level your unit.

### To Level Your Refrigerator:

1. Remove toe grille.
2. Use flat-blade screwdriver or 3/8" socket wrench to adjust front rollers. Use adjustable wrench to adjust leveling screws.

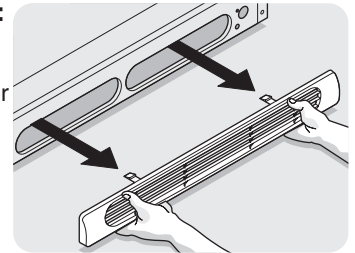

### NOTE

Raise the front of the refrigerator enough so the doors close freely when opened halfway. The refrigerator should slope 1/4" to 1/2" from front to back. Then level the refrigerator from side to side.

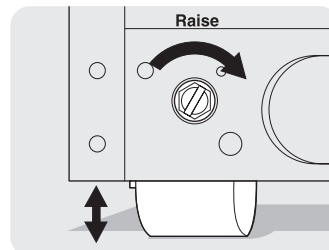

Adjustable Front Roller  
(some models)

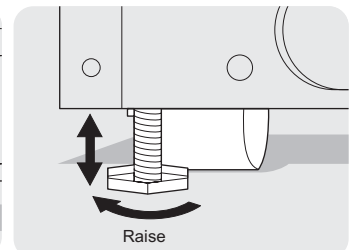

Stationary Front Roller  
with Leveling Screw  
(some models)

## WATER DISPENSER DRIP TRAY

The drip tray for your refrigerator's water dispenser comes from the factory detached. Its removal also allows easy cleaning. To install the drip tray, fit it into the bottom of the dispenser bay and snap into place.

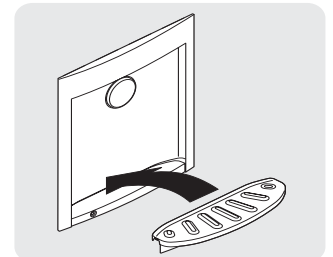



## CONNECTING HOUSEHOLD WATER SUPPLY TO REFRIGERATOR

### **! WARNING**

To avoid electric shock, which can cause death or severe personal injury, disconnect the refrigerator from electrical power before connecting a water supply line to the refrigerator.

### **! CAUTION**

To Avoid Property Damage:

- Copper tubing is recommended for the water supply line. Water supply tubing made of ¼" plastic is not recommended since it greatly increases the potential for water leaks. Manufacturer will not be responsible for any damage if plastic tubing is used for supply line.
- DO NOT install water supply tubing in areas where temperatures fall below freezing.
- Chemicals from a malfunctioning softener can damage the ice maker. If the ice maker is connected to soft water, ensure that the softener is maintained and working properly.

### **IMPORTANT**

Ensure that your water supply line connections comply with all local plumbing codes.

### **Before Installing The Water Supply Line, You Will Need**

- **Basic Tools:** adjustable wrench, flat-blade screwdriver, and Phillips™ screwdriver
- Access to a household cold water line with water pressure between 30 and 100 psi.
- A water supply line made of ¼ inch (6.4 mm) OD, copper tubing. To determine the length of copper tubing needed, you will need to measure the distance from the ice maker inlet valve at the back of the refrigerator to your cold water pipe. Then add approximately 7 feet (2.1 meters), so the refrigerator can be moved out for cleaning (as shown).
- A shutoff valve to connect the water supply line to your household water system. **DO NOT** use a self-piercing type shutoff valve.
- A compression nut and ferrule (sleeve) for connecting the water supply line to the ice maker inlet valve.

### **NOTE**

Water line kit number 5303917950, available from your appliance dealer at additional cost, contains 25 feet (7.6 meters) of ¼ inch OD copper tubing, a saddle type shutoff valve (nonpiercing), (2) ¼ inch brass compression nuts, (2) ferrules/sleeves, and instructions for installing a water supply line.

### **To Connect Water Supply Line To Ice Maker Inlet Valve**

1. Disconnect refrigerator from electric power source.
2. Place end of water supply line into sink or bucket. Turn ON water supply and flush supply line until water is clear. Turn OFF water supply at shutoff valve.
3. Unscrew plastic cap from water valve inlet and discard cap.
4. Slide brass compression nut, then ferrule (sleeve) onto water supply line, as shown.
5. Push water supply line into water valve inlet as far as it will go (¼ inch). Slide ferrule (sleeve) into valve inlet and finger tighten compression nut onto valve. Tighten another half turn with a wrench; **DO NOT** over tighten.
6. With steel clamp and screw, secure water supply line to rear panel of refrigerator as shown.
7. Coil excess water supply line (about 2½ turns) behind refrigerator as shown and arrange coils so they do not vibrate or wear against any other surface.
8. Turn ON water supply at shutoff valve and tighten any connections that leak.
9. Reconnect refrigerator to electrical power source.
10. To turn ice maker on, lower wire signal arm (see ice maker front cover for ON/OFF position of arm).

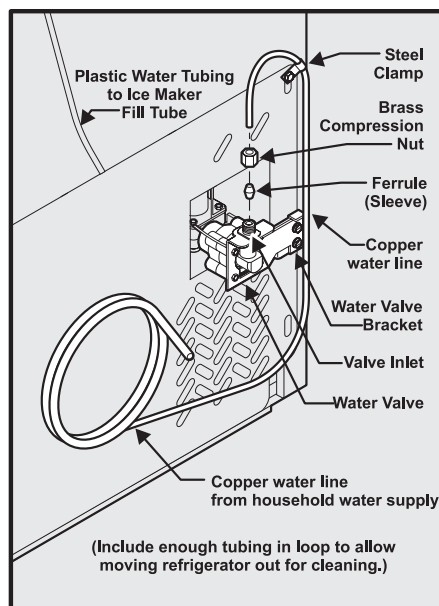



# DOOR REMOVAL

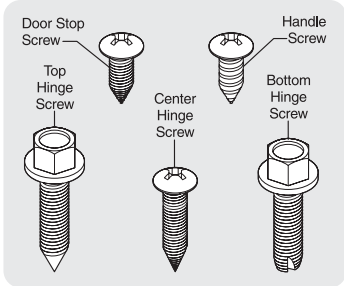

### Tools Necessary:

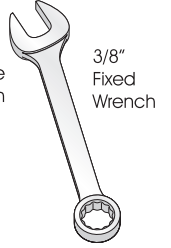
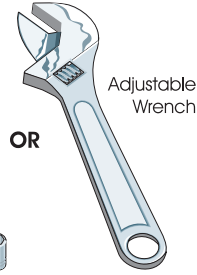
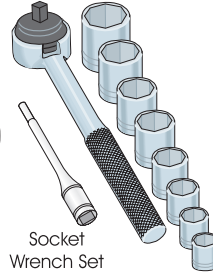
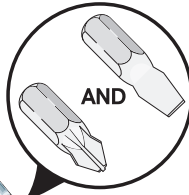
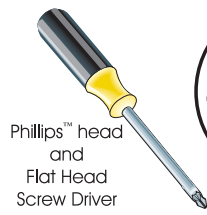

### DOOR REMOVAL INSTRUCTIONS:

If your refrigerator will not fit through an entrance area, you can reduce its size by removing the doors. Check first by measuring the entrance.

#### IMPORTANT

Before you begin, turn the refrigerator temperature control to "0" and remove the electrical power cord from the wall outlet. Remove food from door shelves.

1. Disconnect electrical supply.
2. Remove toe grille (see page 4 to learn how).

#### To remove freezer door:

1. Remove top hinge cover .
2. Trace around the hinge with a soft lead pencil. This makes reinstallation easier.
3. Remove top hinge and lift door off center hinge pin.
4. Reverse this procedure to reinstall freezer door.

#### To remove refrigerator door:

1. Place wood block under door to support its weight.
2. Unfasten the multi-wire cable bracket by removing its screw from the cabinet.
3. Detach the multi-wire cable connector located below the door.  
Place your thumbs on flat sides of each connector, grasp firmly, and bend both ends back and forth while pulling apart.

#### NOTE

You may need to insert a flat screwdriver between the connector ends to release the locking tab (see illustration).

4. Detach the water tube from the connector located below the door. The connector releases when you press its outer sleeve inward.

#### NOTE

If refrigerator has been used, have a container ready to catch excess water from tube.

5. Remove the bottom hinge screws and hinge, holding the door as its weight rests on the wood block. Lay the door on its side to avoid damage to cable and tube.
6. Remove the center hinge screws and hinge. Ensure plastic washer stays on hinge pin.
7. Reverse this procedure to reinstall refrigerator door. When both doors are reinstalled, connect water line by inserting tube and pushing until mark touches face of fitting. Connect cable, replace toe grille, and plug in electrical power cord.

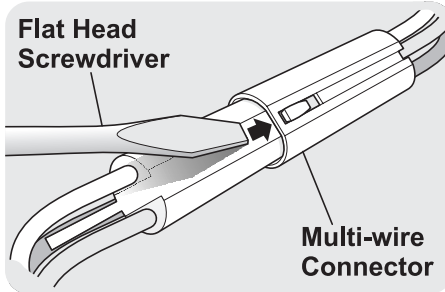
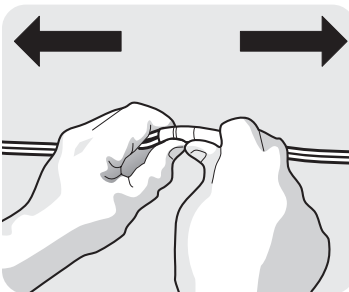
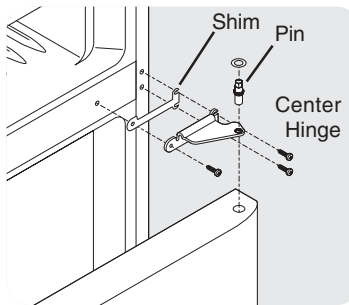
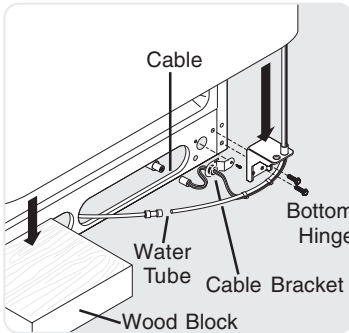
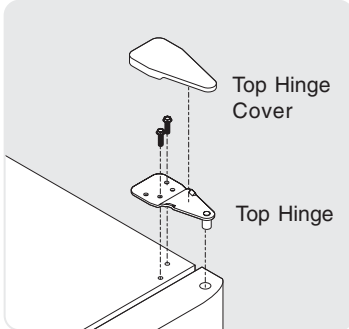

#### TO DISCONNECT

1. Press outer ring against face of fitting

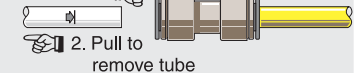

#### TO CONNECT

2. Pull to remove tube
- Insert tube and push until mark touches face of fitting



# TEMPERATURE CONTROLS

## COOL DOWN PERIOD

To ensure safe food storage, allow the refrigerator to operate with the doors closed for at least 8 to 12 hours before loading it with food.

## REFRIGERATOR & FREEZER CONTROLS

### NOTE

When making changes to the temperature controls, wait 24 hours for the temperature to stabilize before making additional changes.

### NOTE

When first turning refrigerator on, move refrigerator and freezer controls to **Normal**. This is the recommended initial setting. After 24 hours, adjust the controls as needed.



Freezer Control (some models)

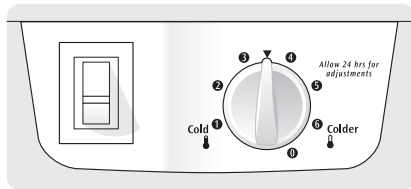

OR

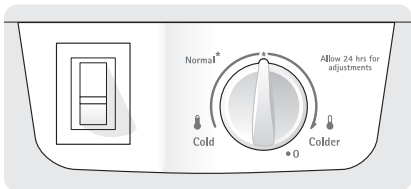

Refrigerator Control  
(some models)

## TEMPERATURE ADJUSTMENT

- **Adjust temperature gradually: move the knob in small increments, allowing the temperature to stabilize.**
- For colder temperatures, turn the knob towards **Colder**.
- For warmer temperatures, turn the knob towards **Cold**.

Turning the refrigerator control will change temperatures in both compartments. For example, if the refrigerator control is turned to a colder setting, the freezer control may have to be adjusted to a warmer setting. Turning the freezer control will change only the freezer temperature.

To maintain temperatures, a fan circulates air in the refrigerator and freezer compartments. For good circulation, do not block cold air vents with food items.

### \* IMPORTANT

Turning the refrigerator temperature control to "0" turns off the compressor and prevents the refrigerator from cooling, but does not disconnect the power to the light bulb and other electrical components. To turn off power to your refrigerator, you must unplug the power cord from the wall outlet.

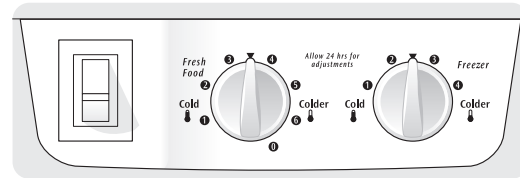

OR

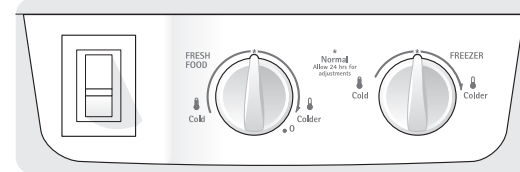

Refrigerator & Freezer Control (some models)

TEMPERATURE ADJUSTMENT GUIDE	
<b>If Refrigerator compartment Is Too Warm</b>	Turn Refrigerator Control Slightly Towards <b>Colder</b> .
<b>If Refrigerator compartment Is Too Cold</b>	Turn Refrigerator Control Slightly Towards <b>Cold</b> .
<b>If Freezer compartment Is Too Warm</b>	Turn Freezer Control Slightly Towards <b>Colder</b> .
<b>If Freezer compartment Is Too Cold</b>	Turn Freezer Control Slightly Towards <b>Cold</b> .
<b>* To Turn Refrigerator Off</b>	Turn Refrigerator Control To <b>0</b> .



## WATER DISPENSER & ICE SERVICE

### WATER DISPENSER

Your refrigerator includes an automatic water dispenser on the front of the refrigerator door. The dispenser is designed to accommodate containers up to 7½ inches high.

### DISPENSING WATER

To operate the water dispenser, press a drinking glass against the dispensing button. Hold the glass as far up as possible, ensuring that the water dispensing spout is inside the lip of the glass.

To stop dispensing water, pull the glass away from the dispensing button. Dispensed water is not cold. For colder water, first add ice to your drinking glass.

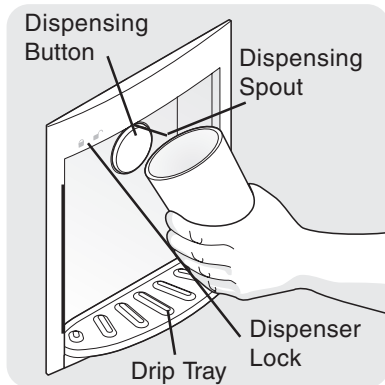

### DRIP TRAY

The drip tray located at the base of the dispenser catches small spills and allows them to evaporate. This tray is removable for easy cleaning.

### NOTE

Please do not pour excess water or ice into the drip tray. It does not have a drain.

### DISPENSER LOCK

The water dispenser includes a switch that allows you to disable the water dispenser. You can use this lock to prevent accidental spills, such as those caused by children pressing the dispensing button without a glass. The switch is located below the locked/unlocked symbols on the dispenser face plate.

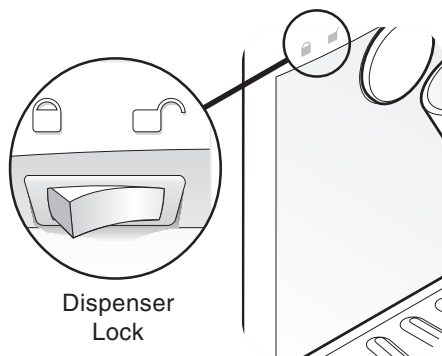

### CAUTION

Lock dispenser whenever cleaning or rearranging food in freezer to prevent accidentally activating the water dispenser while leaning on refrigerator door.

### HOW TO PRIME THE WATER SUPPLY SYSTEM

The water tank, located inside the refrigerator door, automatically fills as water is dispensed.

### CAUTION

For proper dispenser operation, the recommended supply water pressure should fall between 30 psi and 100 psi. Excessive pressure may cause water filter to malfunction.

### To Prime The Water Supply System:

1. Begin filling the tank by pressing and holding a drinking glass against the water dispenser button.
2. Keep the glass in this position until water comes out of the dispenser. There will be noticeable spurts and sputters as the system pushes air out through the system and dispensing spout. This is normal. This may take about 1½ minutes.

### ICE MAKER

If your refrigerator has an automatic ice maker, it will provide a sufficient supply of ice for normal use. During the initial startup of your refrigerator, no ice will be produced during the first 24 hours of operation. Air in new plumbing lines may cause the ice maker to cycle two or three times before making a full tray of ice. With no usage, it will take approximately one to two days to fill the ice container.

New plumbing connections may cause the first production of ice cubes to be discolored or have an odd flavor. Discard ice made during the first 24 hours.

### IMPORTANT

Your ice maker is shipped from the factory with the wire signal arm in the ON position. To ensure proper function of your ice maker, hook up water supply immediately or turn ice maker OFF by lifting the wire signal arm until it clicks and locks in the UP position. **If the ice maker is not turned off and the water supply is not connected, the water valve will make a loud chattering noise.**

### TURNING YOUR ICE MAKER ON

After the plumbing connections have been completed, the water supply valve must be opened. Place the ice container under the ice maker, pushing it as far back as possible. Lower the wire signal arm to its "down" or ON position.



## WATER DISPENSER & ICE SERVICE

### TURNING YOUR ICE MAKER OFF

To stop the ice maker, lift the wire signal arm until it clicks and locks in the “up” or OFF position. The ice maker also turns off automatically when the ice container is full. If your model has an adjustable freezer shelf, place the shelf in the lower position, so that the wire signal arm will hit the ice when the container is full.

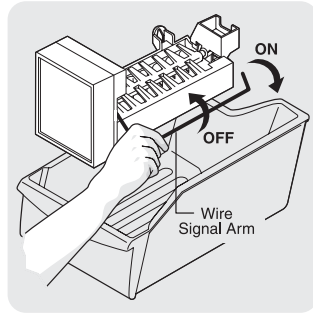

### ICE PRODUCTION: WHAT TO EXPECT

The ice maker will produce 2.5 to 3 pounds of ice every 24 hours depending on usage conditions. Ice is produced at a rate of 8 cubes every 80 to 160 minutes.

#### IMPORTANT

Small Ice cubes or ice chips jamming in the ice maker may be a sign that your water filter needs changing. If you have a side mounted ice maker you may also experience hollow cubes — partially frozen cubes with water inside. When these cubes are harvested they break open and spill water over the other ice cubes in the ice container, forming a solid mass of ice. As the water filter nears the end of its useful life and becomes clogged with particles, less water is delivered to the ice maker during each cycle. The ice maker can't fill every cube in the ice maker mold, leading to small cubes or chips that can get caught between the ice ejector blades and the stripper. **Remember, if your ice maker is jamming with small ice cubes or it's been six months or longer since you last changed your water filter – replace the water filter with a new one. Poor quality household water may require the filter to be changed more frequently.**

#### CAUTION

Chemicals from a malfunctioning softener can damage the ice maker. If the ice maker is connected to soft water, ensure that the softener is maintained and working properly.

#### NOTE

For information on ice maker noises, see *Normal Operating Sounds and Sights* section.

#### CAUTION

**DO NOT** place the ice container in your dishwasher.





## WATER DISPENSER & ICE SERVICE (CONTINUED)

### PureSource™ \*ICE AND WATER FILTER (some models)

Order new filter cartridges through the dealer where you bought the refrigerator, contact the **Electrolux Solutions Hotline** at 1-800-944-9044, or go to our web site at [www.frigidaire.com](http://www.frigidaire.com). It might be good to order some filter cartridges when you first install your refrigerator. Be sure to ask for **the RG-100 PureSource™\* replacement cartridge**.

#### System Startup:

Water supply does not need to be turned off, however, do not use ice and water dispenser while installing filter. The filter cartridge has already been installed in the filter housing at the factory. Refer to the *How to Prime the Water Supply System* section to properly fill the system with water.

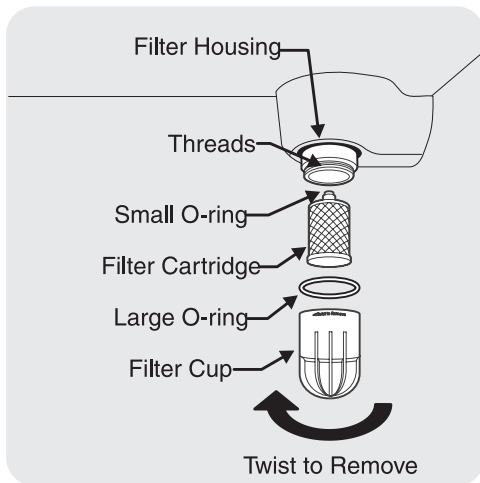

#### Changing the Filter:

Water conditions vary throughout the world, but changing the water filter every 6 - 9 months normally will ensure the highest possible water quality. **Ice jams in the ice maker and/or hollow ice cubes (partially frozen cubes with water inside), may also be a sign that your water filter needs changing.** If the filter has been in a refrigerator that has not been in use for awhile (during moving for example), change the filter before reinstalling the refrigerator. The dispenser system will also operate without filtration (with filter cartridge removed).

#### To change filter:

It is not necessary to turn the water supply off to change the filter.

1. Set ice maker wire signal arm to the OFF (up) position. Turn dispenser lock to the locked position.
2. Hold filter cup firmly, and unscrew towards left (Some water could leak out as you remove cup. This is normal.). Filter cartridge should come down with cup. If cartridge remains in housing, pull down gently, while twisting filter back and forth.
3. Rinse out cup under running water.
4. The large o-ring that seals the filter system sets in the o-ring groove down inside the cup. Should the o-ring fall out during filter cartridge replacement, simply place it back in the groove prior to screwing the cup back in place. If the o-ring becomes damaged, you will need to order one from the *Electrolux Solutions Hotline*.
5. Discard old filter cartridge.
6. Remove new filter cartridge from packaging and place in cup. The end with the small o-ring should be up, out of the cup.
7. Screw cup, with filter, back onto housing. **Do Not Use Wrench To Reinstall Cup.** Filter cartridge will self-align as cup is tightened. Be sure cup is completely tightened with **PureSource™** logo facing outward. **Do Not Tighten Past Stop.**
8. Set ice maker wire signal arm to the ON (down) position.
9. Check for leaks. Open refrigerator door. Wipe any water droplets from the filter cup. Unlock the dispenser lock. Fill a glass with water. If there is a leak, unscrew filter cup, and reinsert the filter cartridge. Check placement of large O-ring. Reinstall filter cup, making certain it is tightened completely.
10. To prime filter system and purge air from water line, continue flushing the system for approximately 3 minutes to assure that the purest water possible is stored in the water tank. There will be noticeable spurts and sputters as the system pushes air out through the system and out the dispensing spout. This is normal.



The **PureSource™ \* NGRG-2000** Ice and Water Filter System with the **RG-100** cartridge is tested and certified by NSF International,

the nationally recognized and respected, not for profit, certification organization for public health safety. The **PureSource™\*** system is tested and certified to ANSI/NSF Standard 42. See performance data sheet for specifications. This system should not be used on water that is microbiologically unsafe or with water of unknown quality unless the water has been adequately disinfected before or after traveling through the filtration system.

- Rated Capacity - 400 gallons
- Rated service flow - .5 GPM
- Maximum Rated Pressure - 100 PSI
- Maximum Operating Temp. - 100° F

### FILTER REPLACEMENT REMINDER STICKERS

There is a set of Reminder Stickers included in the envelope that the Use & Care Guide came in. Choose a dated sticker that indicates 6 - 9 months (depending on your water quality and usage) from the date of installation. Place the sticker on the front

\* White Westinghouse uses the name CrystalClear instead of PureSource, but they are the same filter



## NORMAL OPERATING SOUNDS & SIGHTS

### UNDERSTANDING THE SOUNDS YOU MAY HEAR

Your new high-efficiency refrigerator may make unfamiliar sounds. These are all normal sounds and soon will become familiar to you. They also indicate your refrigerator is operating as designed. Hard surfaces, such as vinyl or wood floors, walls, and kitchen cabinets may make sounds more noticeable. Listed below are descriptions of some of the most common sounds you may hear, and what is causing them.

#### NOTE

Rigid foam insulation is very energy efficient, but is not a sound insulator.

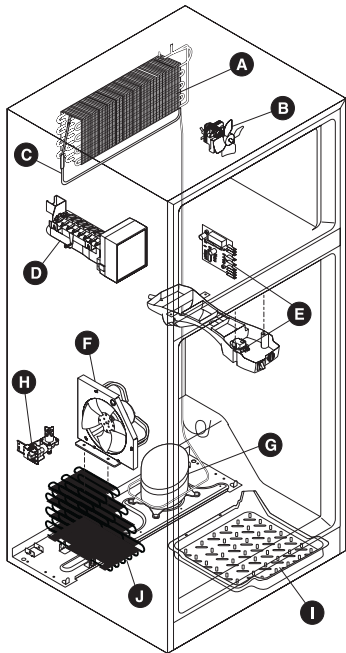

#### A. Evaporator

The flow of refrigerant through the evaporator may create a boiling or gurgling sound.

#### B. Evaporator Fan

You may hear air being forced through the refrigerator by the evaporator fan.

#### C. Defrost Heater

During defrost cycles, water dripping onto the defrost heater may cause a hissing or sizzling sound. After defrosting, a popping sound may occur.

#### IMPORTANT

During the automatic defrost cycle, you may notice a red glow in the vents on the back wall of your freezer compartment. This is normal during the defrost cycle.

#### D. Automatic Ice Maker

If your refrigerator is equipped with an automatic ice maker, you will hear ice cubes falling into the ice bin.

#### E. Cold Control & Defrost Timer or Automatic Defrost Control

These parts can produce a snapping or clicking sound when turning the refrigerator on and off. The timer also produces sounds similar to an electric clock.

#### F. Condenser Fan

If condenser coils are located underneath your refrigerator as shown in the drawing at the left, you have a condenser fan. You may hear air being forced through the condenser by the condenser fan.

#### G. Compressor

Modern, high-efficiency compressors operate much faster than older models. The compressor may have a high-pitched hum or pulsating sound.

#### H. Water Valve

If your refrigerator is equipped with an automatic ice maker, you will hear a buzzing sound as the water valve opens to fill the ice maker during each cycle.

#### I. Drain Pan (Nonremovable)

You may hear water running into the drain pan during the defrost cycle. The drain pan will be located on top of the compressor for air-cooled condensers (black coils on back of refrigerator).

#### J. Condenser Coils (Fan-cooled models only)



## CARE & CLEANING

### REPLACING THE FREEZER LIGHT BULB (SOME MODELS)

#### CAUTION

Avoid cuts when replacing light bulbs, wear gloves.

1. Unplug refrigerator.
2. Wear gloves as protection against possible broken glass.
3. Unsnap light shield.
4. Unscrew and replace old bulb with an appliance bulb of the same wattage.
5. Replace light shield.
6. Remember to plug the refrigerator back in.



## CARE & CLEANING

Keep your refrigerator and freezer clean to prevent odor build-up. Wipe up any spills immediately and clean both sections at least twice a year. **Never** use any type of scouring pads, brushes, abrasive cleaners or strong alkaline solutions on any surface. **Do not** wash any removable parts in a dishwasher. **Always unplug the electrical power cord from the wall outlet before cleaning.**

### CAUTION

- When moving the refrigerator, pull straight out. Do not shift the refrigerator from side to side as this may tear or gouge the floor covering. If the refrigerator has an automatic ice maker, be careful not to move the refrigerator beyond the plumbing connections.
- Damp objects stick to cold metal surfaces. Do not touch refrigerated surfaces with wet or damp hands.
- Never use CHLORIDE to clean stainless steel.

### NOTE

- Turning the refrigerator temperature control to “0” turns off the compressor, but does not disconnect electrical power to the light bulb or other electrical components. To turn off power to your refrigerator, you must unplug the power cord from the wall outlet.
- Do not use razor blades or other sharp instruments which can scratch the appliance surface when removing adhesive labels. Any glue left from tape or labels can be removed with a mixture of warm water and mild detergent, or, touch the glue residue with the sticky side of tape you have already removed. **Do not remove the serial plate.**

## Care & Cleaning Chart

Part	What To Use	Tips and Precautions
Interior/Door Liner	<ul style="list-style-type: none"> <li>• Soap and water</li> <li>• Baking soda and water</li> </ul>	Use 2 tablespoons of baking soda in 1 quart of warm water. <b>Be sure to wring excess water out of sponge or cloth before cleaning around controls, light bulb or any electrical part.</b>
Door Gaskets	<ul style="list-style-type: none"> <li>• Soap and water</li> </ul>	Wipe gaskets with a clean soft cloth.
Drawers/Bins	<ul style="list-style-type: none"> <li>• Soap and water</li> </ul>	Do not wash any removable items (bins, drawers, etc.) in dishwasher.
Glass Shelves	<ul style="list-style-type: none"> <li>• Soap and water</li> <li>• Glass cleaner</li> <li>• Mild liquid sprays</li> </ul>	Allow glass to warm to room temperature before immersing in warm water.
Toe Grille	<ul style="list-style-type: none"> <li>• Soap and water</li> <li>• Mild liquid sprays</li> <li>• Vacuum attachment</li> </ul>	Vacuum dust from front of toe grille. Remove toe grille Vacuum backside and wipe with sudsy cloth or sponge. Rinse and dry.
Exterior and Handles	<ul style="list-style-type: none"> <li>• Soap and water</li> </ul>	Do not use commercial household cleaners, ammonia, or alcohol to clean handles.
Exterior and Handles (Stainless Steel Models Only)	<ul style="list-style-type: none"> <li>• Soap and water</li> <li>• Ammonia</li> <li>• Stainless Steel Cleaners</li> </ul>	<p><b>CAUTION: Never use CHLORIDE to clean stainless steel.</b></p> <p>Clean stainless steel front and handles with non-abrasive soapy water and a dishcloth. Rinse with clean water and a soft cloth. Wipe stubborn spots with an ammonia-soaked paper towel, and rinse. Use a non-abrasive stainless steel cleaner. These cleaners can be purchased at most home improvement or major department stores. Always follow manufacturer's instructions.</p> <p>NOTE: Always clean, wipe and dry with the grain to prevent cross-grain scratching. Wash the rest of the cabinet with warm water and mild liquid detergent. Rinse well, and wipe dry with a clean soft cloth.</p>
Condenser Coils (Fan-cooled models only)	<ul style="list-style-type: none"> <li>• Condenser Cleaning Brush is available from your dealer.</li> <li>• Vacuum Cleaner</li> </ul>	No need to clean unless operating refrigerator under particularly dusty or greasy conditions, or if there is significant pet traffic in your home. If cleaning is necessary, remove toe grille and use extended vacuum attachment and condenser cleaning brush to remove dust build-up from condenser coils (see item “J” in “NORMAL OPERATING SOUNDS & SIGHTS”).
Condenser Coils (Air-cooled models only)	<ul style="list-style-type: none"> <li>• Vacuum Cleaner</li> </ul>	Use the dusting tool attachment on your vacuum to remove dust build-up on the condenser coils (black tubes and wires) attached to the back of air-cooled refrigerators only.
Defrost Water Pan	<ul style="list-style-type: none"> <li>• Soap and water</li> </ul>	Some models have defrost water pan located on top of compressor at bottom rear of refrigerator (see illustration on next page). Wipe water pan with damp cloth. NOTE: The defrost water pan is NOT removable.
Exterior (Easy Care Stainless Steel Models)	<ul style="list-style-type: none"> <li>• Soap and water</li> <li>• Mild liquid sprays</li> </ul>	<p><b>CAUTION: DO NOT use abrasive or stainless steel cleaners on Easy Care Stainless Steel Models. It will remove the protective finish.</b></p> <p>Use warm soapy water to clean Easy Care surfaces. Mild liquid sprays may be used on stubborn spots.</p>



# Major Appliance Warranty Information

Your appliance is covered by a one year limited warranty. For one year from your original date of purchase, Electrolux will pay all costs for repairing or replacing any parts of this appliance that prove to be defective in materials or workmanship when such appliance is installed, used and maintained in accordance with the provided instructions.

**Exclusions**      **This warranty does not cover the following:**

1. Products with original serial numbers that have been removed, altered or cannot be readily determined.
2. Product that has been transferred from its original owner to another party or removed outside the USA or Canada.
3. Rust on the interior or exterior of the unit.
4. Products purchased "as-is" are not covered by this warranty.
5. Food loss due to any refrigerator or freezer failures.
6. Products used in a commercial setting.
7. Service calls which do not involve malfunction or defects in materials or workmanship, or for appliances not in ordinary household use or used other than in accordance with the provided instructions.
8. Service calls to correct the installation of your appliance or to instruct you how to use your appliance.
9. Expenses for making the appliance accessible for servicing, such as removal of trim, cupboards, shelves, etc., which are not a part of the appliance when it is shipped from the factory.
10. Service calls to repair or replace appliance light bulbs, air filters, water filters, other consumables, or knobs, handles, or other cosmetic parts.
11. Surcharges including, but not limited to, any after hour, weekend, or holiday service calls, tolls, ferry trip charges, or mileage expense for service calls to remote areas, including the state of Alaska.
12. Damages to the finish of appliance or home incurred during installation, including but not limited to floors, cabinets, walls, etc.
13. Damages caused by: services performed by unauthorized service companies; use of parts other than genuine Electrolux parts or parts obtained from persons other than authorized service companies; or external causes such as abuse, misuse, inadequate power supply, accidents, fires, or acts of God.

**DISCLAIMER OF IMPLIED WARRANTIES; LIMITATION OF REMEDIES**

CUSTOMER'S SOLE AND EXCLUSIVE REMEDY UNDER THIS LIMITED WARRANTY SHALL BE PRODUCT REPAIR OR REPLACEMENT AS PROVIDED HEREIN. CLAIMS BASED ON IMPLIED WARRANTIES, INCLUDING WARRANTIES OF MERCHANTABILITY OR FITNESS FOR A PARTICULAR PURPOSE, ARE LIMITED TO ONE YEAR OR THE SHORTEST PERIOD ALLOWED BY LAW, BUT NOT LESS THAN ONE YEAR. ELECTROLUX SHALL NOT BE LIABLE FOR CONSEQUENTIAL OR INCIDENTAL DAMAGES SUCH AS PROPERTY DAMAGE AND INCIDENTAL EXPENSES RESULTING FROM ANY BREACH OF THIS WRITTEN LIMITED WARRANTY OR ANY IMPLIED WARRANTY. SOME STATES AND PROVINCES DO NOT ALLOW THE EXCLUSION OR LIMITATION OF INCIDENTAL OR CONSEQUENTIAL DAMAGES, OR LIMITATIONS ON THE DURATION OF IMPLIED WARRANTIES, SO THESE LIMITATIONS OR EXCLUSIONS MAY NOT APPLY TO YOU. THIS WRITTEN WARRANTY GIVES YOU SPECIFIC LEGAL RIGHTS. YOU MAY ALSO HAVE OTHER RIGHTS THAT VARY FROM STATE TO STATE.

**If You Need Service**      Keep your receipt, delivery slip, or some other appropriate payment record to establish the warranty period should service be required. If service is performed, it is in your best interest to obtain and keep all receipts. Service under this warranty must be obtained by contacting Electrolux at the addresses or phone numbers below.

This warranty only applies in the USA and Canada. In the USA, your appliance is warranted by Electrolux Major Appliances North America, a division of Electrolux Home Products, Inc. In Canada, your appliance is warranted by Electrolux Canada Corp. Electrolux authorizes no person to change or add to any obligations under this warranty. Obligations for service and parts under this warranty must be performed by Electrolux or an authorized service company. Product features or specifications as described or illustrated are subject to change without notice.

**USA**  
**1.800.944.9044**  
Electrolux Major Appliances  
North America  
P.O. Box 212378  
Augusta, GA 30907



**Canada**  
**1.800.668.4606**  
Electrolux Canada Corp.  
5855 Terry Fox Way  
Mississauga, Ontario, Canada  
L5V 3E4



## BEFORE YOU CALL

1-800-944-9044 (United States)

1-800-668-4606 (Canada)

Visit our web site at  
[www.frigidaire.com](http://www.frigidaire.com).

PROBLEM	CAUSE	CORRECTION
<b>RUNNING OF REFRIGERATOR</b>		
<b>Compressor does not run.</b>	<ul style="list-style-type: none"> <li>Refrigerator control is set to OFF.</li> <li>Refrigerator is in defrost cycle.</li> <li>Plug at electrical outlet is disconnected.</li> <li>House fuse blown or tripped circuit breaker.</li> <li>Power outage.</li> </ul>	<ul style="list-style-type: none"> <li>Set refrigerator control. See <b>Temperature Controls</b> section.</li> <li>This is normal for a fully automatic defrost refrigerator. The defrost cycle occurs periodically, lasting about 30 minutes.</li> <li>Ensure plug is tightly pushed into outlet.</li> <li>Check/replace fuse with a 15 amp time-delay fuse. Reset circuit breaker.</li> <li>Check house lights. Call local Electric Company.</li> </ul>
<b>TEMPERATURES ARE TOO COLD</b>		
<b>Freezer temperature too cold. Fresh Food temperature is satisfactory.</b>	<ul style="list-style-type: none"> <li>Freezer control is set too cold.</li> </ul>	<ul style="list-style-type: none"> <li>Set freezer control to a warmer setting. Allow 24 hours for temperature to stabilize.</li> </ul>
<b>Fresh Food temperature too cold. Freezer temperature is satisfactory.</b>	<ul style="list-style-type: none"> <li>Fresh Food control is set too cold.</li> </ul>	<ul style="list-style-type: none"> <li>Set fresh food control to a warmer setting. Allow 24 hours for temperature to stabilize.</li> </ul>
<b>AUTOMATIC ICE MAKER</b>		
<b>Ice maker is not making any ice.</b>	<ul style="list-style-type: none"> <li>Ice maker wire signal arm is in the "up" or OFF position.</li> <li>Household water line valve is not open.</li> <li>Freezer is not cold enough.</li> <li>Saddle valve on cold water pipe is clogged or restricted by foreign material.</li> </ul>	<ul style="list-style-type: none"> <li>Move wire signal arm to the "down" or ON position. (side mounted)</li> <li>Turn on household water line valve.</li> <li>Set freeze control to a colder setting. Allow 24 hours for temperature to stabilize.</li> <li>Turn off household water line valve. Remove valve. Ensure that valve is not a self-piercing saddle valve. Clean valve. Replace valve if necessary.</li> </ul>
<b>Ice maker is not making enough ice.</b>	<ul style="list-style-type: none"> <li>Ice maker is producing less ice than you expect.</li> <li>Freezer is not cold enough.</li> <li>Household water line valve is not completely open.</li> </ul>	<ul style="list-style-type: none"> <li>Ice maker should produce 2 ½ to 3 pounds of ice every 24 hours.</li> <li>Set freeze control to a colder setting. Allow 24 hours for temperature to stabilize.</li> <li>Turn on household water line valve.</li> </ul>
<b>Ice cubes are freezing together.</b>	<ul style="list-style-type: none"> <li>Ice cubes are not being used frequently enough.</li> <li>Ice cubes are hollow (partially frozen cubes with water inside).</li> </ul>	<ul style="list-style-type: none"> <li>Remove ice container and discard ice from container. Ice maker will produce fresh supply.</li> <li>The ice &amp; water filter cartridge may be clogged. Replace filter cartridge.</li> </ul>
<b>WATER DISPENSER</b>		
<b>Dispenser will not dispense water.</b>	<ul style="list-style-type: none"> <li>Household water line valve is not open.</li> <li>Freezer door is not closed.</li> <li>Ice &amp; water filter cartridge is clogged.</li> </ul>	<ul style="list-style-type: none"> <li>Open household water line valve. See <b>PROBLEM</b> section <b>ICE MAKER IS NOT MAKING ANY ICE</b>.</li> <li>Ensure that freezer door is closed.</li> <li>Replace filter cartridge.</li> </ul>
<b>Water pressure is extremely low.</b>	<ul style="list-style-type: none"> <li>Cut-off and cut-on pressures are too low (well systems only).</li> <li>Reverse osmosis system is in regenerative phase.</li> </ul>	<ul style="list-style-type: none"> <li>Have someone turn up the cut-off and cut-on pressure on the water pump system (well systems only).</li> <li>It is normal for a reverse osmosis system to be below 20 psi during the regenerative phase.</li> </ul>