

Use & Care Manual

Visit the Frigidaire Web Site at: <http://www.frigidaire.com>

Gas Range

*ES530 Control, Self-Cleaning Oven
with Deep Well Style Cooktop*

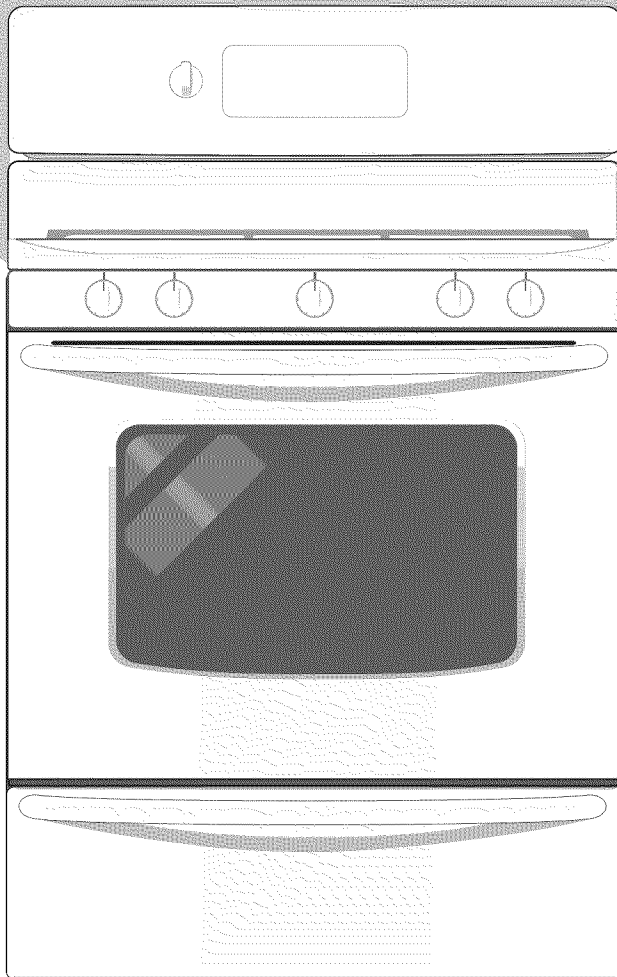

Questions or for Service Call:

1-800-944-9044 (U.S.)

1-800-668-4606 (Canada)

Welcome 2



Important Safety Instructions 3-4



Features at a Glance 5



Before Setting Oven Controls 6



Setting Surface Controls 7



Warming Drawer Controls 8-9



Control Pad Features 10



Setting Oven Controls 11-24



Self Cleaning 25-27



Adjusting Oven Temperature 27



General Care & Cleaning 28-30



Before You Call
Solutions to Common Problems 31



Warranty Back Page





Welcome & Congratulations

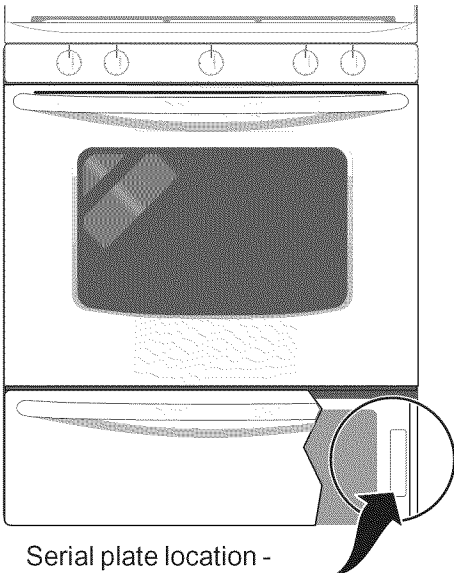

Serial plate location -

Open the Warming Drawer (some models) or Storage Drawer (some models).

Congratulations on your purchase of a new range! At **Electrolux Home Products**, we are very proud of our product and are completely committed to providing you with the best service possible. Your satisfaction is our number one priority.

We know you'll enjoy your new range and **Thank You** for choosing our product. We hope you consider us for future purchases.

PLEASE CAREFULLY READ AND SAVE THESE INSTRUCTIONS

This Use & Care Manual provides specific operating instructions for your model. Use your range only as instructed in this manual. These instructions are not meant to cover every possible condition and situation that may occur. Common sense and caution must be practiced when installing, operating and maintaining any appliance.

Please record your model and serial numbers below for future reference.

Model Number: _____

Serial Number: _____

Purchase Date: _____

This Use & Care Manual contains general operating instructions for your appliance and feature information for several models. Your range **may not** have all the described features. The graphics shown are representative. The graphics on your range may not look exactly like those shown.

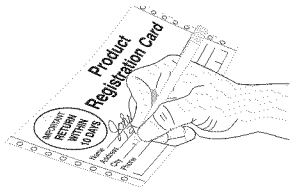

Product Registration

Be sure to register your product. The self-addressed **PRODUCT REGISTRATION CARD** should be filled in completely, signed and returned to Electrolux Home Products.

Grounding type wall receptacle

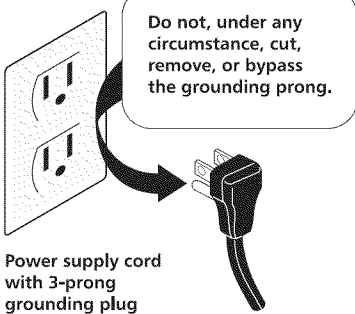

Power supply cord with 3-prong grounding plug

Grounding Instructions

WARNING Avoid fire hazard or electrical shock. Do not use an adapter plug, an extension cord, or remove grounding prong from electrical power cord. Failure to follow this warning can cause serious injury, fire or death.

WARNING This appliance is equipped with a 3-prong grounding plug for your protection against shock hazard and should be plugged directly into a properly grounded receptacle. **DO NOT** cut or remove the grounding prong from this plug.

For personal safety, the range must be properly grounded. For maximum safety, the power cord must be plugged into an electrical outlet that is correctly polarized and properly grounded. If a 2-prong wall receptacle is the only available outlet, it is the personal responsibility of the consumer to have it replaced with a properly grounded 3-prong wall receptacle installed by a qualified electrician.

See the **INSTALLATION INSTRUCTIONS** packaged with this range for complete installation and grounding instructions.

Conversion to Liquefied Petroleum Gas (or L.P. Gas)

WARNING Personal injury or death from electrical shock may occur if the range is not installed by a qualified installer or electrician.

CAUTION Any additions, changes or conversions required in order for this appliance to satisfactorily meet the application needs must be made by a qualified technician.

The natural gas range is designed to allow for conversion to Liquefied Petroleum (L.P.) Gas.

If L.P. conversion is needed, contact your local appliance dealer for assistance. The L.P. Conversion Kit may be obtained from your appliance dealer and should be installed by a qualified service technician. Before installing the kit be sure to follow the L.P. Installation Instructions carefully.

Important Safety Instructions



Read all instructions before using this appliance. Save these instructions for future reference.

This manual contains important safety symbols and instructions. Please pay attention to these symbols and follow all instructions given.

⚠ WARNING This symbol will help alert you to situations that may cause serious bodily harm, death or property damage.

⚠ CAUTION This symbol will help alert you to situations that may cause bodily injury or property damage.

⚠ WARNING If the information in this manual is not followed exactly, a fire or explosion may result causing property damage, personal injury or death.

FOR YOUR SAFETY:

- Do not store or use gasoline or other flammable vapors and liquids in the vicinity of this or any other appliance.
 - **WHAT TO DO IF YOU SMELL GAS:**
 - Do not try to light any appliance.
 - Do not touch any electrical switch; do not use any phone in your building.
 - Immediately call your gas supplier from a neighbor's phone. Follow the gas supplier's instructions.
 - If you cannot reach your gas supplier, call the fire department.
 - Installation and service must be performed by a qualified installer, servicer or the gas supplier.
- **Remove all tape and packaging before using the range.**
Destroy the carton and plastic bags after unpacking the range. Never allow children to play with packaging material.
 - **Proper Installation—Be sure your appliance is properly installed and grounded by a qualified technician in accordance with the National Fuel Gas Code ANSI Z223.- latest edition, or in Canada CAN/CGA B149.1, and CAN/CGA B149.2, and the the National Electrical Code ANSI/NFPA No.70-latest edition, or in Canada CSA Standard C22.1, Canadian Electrical Code, Part 1, and local code requirements.** Install only per installation instructions provided in the literature package for this range.
Ask your dealer to recommend a qualified technician and an authorized repair service. Know how to disconnect the power to the range at the circuit breaker or fuse box in case of an emergency.
 - **User servicing—Do not repair or replace any part of the appliance unless specifically recommended in the manuals.** All other servicing should be done only by a qualified technician. This may reduce the risk of personal injury and damage to the range.
 - **Never modify or alter the construction of a range by removing leveling legs, panels, wire covers, anti-tip brackets/screws, or any other part of the product.**

⚠ WARNING

- All ranges can tip.
- Injury to persons could result.
- Install anti-tip device packed with range.
- See Installation Instructions.



⚠ WARNING To reduce the risk of tipping, the range must be secured by properly installed anti-tip bracket provided with the range. To check if the bracket is installed properly, visually check that rear leveling leg is inserted into and fully secured by the anti-tip bracket by removing lower panel or storage drawer. For models with a warmer drawer, grasp the top rear edge of the range and carefully attempt to tilt it forward. Refer to the installation instructions for proper anti-tip bracket installation.

⚠ WARNING NEVER use this appliance as a space heater to heat or warm the room. Doing so may result in carbon monoxide poisoning.

⚠ WARNING NEVER cover any slots, holes or passages in the oven bottom or cover an entire rack with materials such as aluminum foil. Doing so blocks air flow through the oven and may cause carbon monoxide poisoning. Aluminum foil linings may trap heat, causing a fire hazard.

⚠ WARNING Stepping, leaning or sitting on the doors or drawers of this range can result in serious injuries and also cause damage to the range. Do not allow children to climb or play around the range. The weight of a child on an open door may cause the range to tip, resulting in serious burns or other injury.

⚠ WARNING Do not use the oven or warmer drawer (if equipped) for storage.

⚠ CAUTION Do not store items of interest to children in the cabinets above a range or on the backguard of a range. Children climbing on the range to reach items could be seriously injured.

⚠ WARNING Never Use Your Appliance for Warming or Heating the Room.

- **Storage in or on Appliance—Flammable materials should not be stored in an oven, warmer drawer, near surface burners or in the storage drawer.** This includes paper, plastic and cloth items, such as cookbooks, plasticware and towels, as well as flammable liquids. Do not store explosives, such as aerosol cans, on or near the range.



Important Safety Instructions

- **Do Not Leave Children Alone**—Children should not be left alone or unattended in the area where appliance is in use. They should never be allowed to sit or stand on any part of the appliance.
- **DO NOT TOUCH SURFACE BURNERS, AREAS NEAR THESE BURNERS, OVEN BURNERS OR INTERIOR SURFACES OF THE OVEN.** Both surface and oven burners may be hot even though flames are not visible. Areas near surface burners may become hot enough to cause burns. During and after use, do not touch, or let clothing or other flammable materials touch these areas until they have had sufficient time to cool. Among these areas are the cook top, surfaces facing the cook top, the oven vent openings and surfaces near these openings, oven door and window.
- **Wear Proper Apparel**—Loose-fitting or hanging garments should never be worn while using the appliance. Do not let clothing or other flammable materials contact hot surfaces.
- **Do Not Use Water or Flour on Grease Fires**—Smother the fire with a pan lid, or use baking soda, a dry chemical or foam-type extinguisher.
- **When heating fat or grease, watch it closely.** Fat or grease may catch fire if allowed to become too hot.
- **Use Only Dry Potholders**—Moist or damp potholders on hot surfaces may result in burns from steam. Do not let potholders touch hot heating burners. Do not use a towel or other bulky cloth instead of a potholder.
- **Do Not Heat Unopened Food Containers**—Buildup of pressure may cause container to burst and result in injury.
- **Remove the oven door from any unused range if it is to be stored or discarded.**

IMPORTANT—ELECTRIC IGNITION MODELS ONLY: Do not attempt to operate the oven during a power failure. If the power fails, always turn off the oven. If the oven is not turned off and the power resumes, the oven will begin to operate again. Once the power resumes, reset the clock and oven function.

IMPORTANT INSTRUCTIONS FOR USING YOUR COOKTOP

⚠ WARNING Use Proper Flame Size—Adjust flame size so it does not extend beyond the edge of the utensil. The use of undersized utensils will expose a portion of the burner flame to direct contact and may result in ignition of clothing. Proper relationship of utensil to flame will also improve efficiency.

- **Know which knob controls each surface burner.** Place a pan of food on the burner before turning it on, and turn the burner off before removing the pan.
- **Always turn knob to the full LITE position when igniting top burners.** Visually check that burner has lit. Then adjust the flame so it does not extend beyond the edge of the utensil.
- **Utensil Handles Should Be Turned Inward and Not Extend Over Adjacent Surface Burners**—To reduce the risk of burns, ignition of flammable materials, and spillage due to unintentional contact with the utensil, the handle of the utensil should be positioned so that it is turned inward, and does not extend over adjacent surface burners.
- **Never Leave Surface Burners Unattended at High Heat Settings**—Boilovers cause smoking and greasy spillovers that may ignite, or a pan that has boiled dry may melt.
- **Protective Liners**—Do not use aluminum foil to line surface burner pans, or oven bottom, except as suggested in this manual. Improper installation of these liners may result in risk of electric shock, or fire.

- **Glazed Cooking Utensils**—Only certain types of glass, glass/ceramic, ceramic, earthenware, or other glazed utensils are suitable for cooktop service without breaking due to the sudden change in temperature. Check the manufacturer's recommendations for cooktop use.

IMPORTANT INSTRUCTIONS FOR USING YOUR OVEN

- **Use Care When Opening Oven Door or Warmer Drawer**—Stand to the side of the range when opening the door of a hot oven. Let hot air or steam escape before you remove or replace food in the oven.
- **Keep Oven Vent Ducts Unobstructed.** The oven vent is located below the backguard. Touching the surfaces in this area when the oven is operating may cause severe burns. Also, do not place plastic or heat-sensitive items on or near the oven vent. These items could melt or ignite.
- **Placement of Oven Racks.** Always place oven racks in desired location while oven is cool. If rack must be moved while oven is hot use extreme caution. Use potholders and grasp the rack with both hands to reposition. Do not let potholders contact the hot heating elements in the oven. Remove all utensils from the rack before moving.
- **Do not use the broiler pan without its insert.** The broiler pan and its insert allow dripping fat to drain and be kept away from the high heat of the broiler.
- **Do not cover the broiler insert with aluminum foil. Exposed fat and grease could ignite.**
- Cold temperatures can damage the electronic control. When using the appliance for the first time, or when the appliance has not been used for an extended period of time, be certain the unit has been in temperatures above 32°F (0°C) for at least 3 hours before turning on the power to the appliance.

IMPORTANT INSTRUCTIONS FOR CLEANING YOUR RANGE

- **Clean the range regularly to keep all parts free of grease that could catch fire.** Pay particular attention to the area underneath each surface element. Do not allow grease to accumulate. Refer to the range manufacturer's instructions for cleaning.
- **Kitchen cleaners and aerosols**—Always follow the manufacturer's recommended directions for use. Be aware that excess residue from cleaners and aerosols may ignite causing damage and injury.

SELF CLEANING OVENS

- **Clean in the self-cleaning cycle only the parts listed in this Owner's Guide.** Before self cleaning the oven, remove the broiler pan and any utensils or foods from the oven.
- **Do Not Use Oven Cleaners**—No commercial oven cleaner or oven liner protective coating of any kind should be used in or around any part of the oven.
- **Do Not Clean Door Gasket**—The door gasket is essential for a good seal. Care should be taken not to rub, damage or move the gasket.

Important Safety Notice

The California Safe Drinking Water and Toxic Enforcement Act requires the Governor of California to publish a list of substances known to the state to cause cancer, birth defects or other reproductive harm, and requires businesses to warn customers of potential exposure to such substances.

Features At A Glance

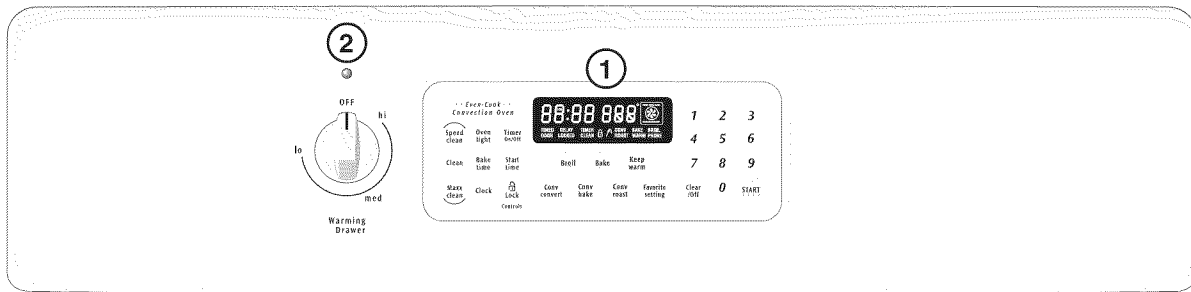

Your Gas Range Features Include:

1. Electronic Oven Control with Kitchen Timer.
2. Warming Drawer Control & Indicator Light (some models).
3. Left Front Burner Valve & Knob.
4. Left Rear Burner Valve & Knob.
5. Center Burner Valve & Knob (some models).
6. Right Rear Burner Valve & Knob.
7. Right Front Burner Valve & Knob.
8. Easy to clean Deep Well style cooktop.
9. Dishwasher safe Burner Grates (styles & colors vary by model).
10. Dishwasher safe Center Burner Grate (some models)
11. Self-Clean Oven Door Latch.
12. Automatic Oven Door Light Switch (some models).
13. Oven Interior Light with Shield.
14. Self-Cleaning Oven interior.
15. Adjustable Oven Rack(s).
16. Convection Fan & Cover.
17. Large 1 piece Oven Door Handle.
18. Full width Oven Door (styles vary with model).
19. Warming Drawer and Handle (some models) or Storage Drawer with integrated handle (some models).
20. 5,000 BTU Simmer Burner (some models).
21. 9,500 BTU Burner (some models).
22. 12,000 BTU Power Plus Burner (some models).
23. 14,000 BTU Power Plus Burner (some models).
24. 16,000 BTU Power Plus Burner (some models).
25. 9,500 BTU Accent Burner (some models).
26. Broil Pan (some models).
27. Broil Pan Insert (some models).
28. Roasting Rack.
29. Center Griddle Grate
30. Leveling Legs & Anti-tip Bracket (included).
Burner Drip pans (some models).

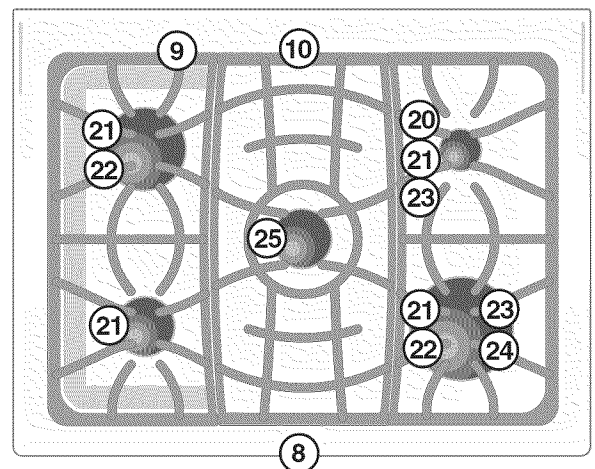
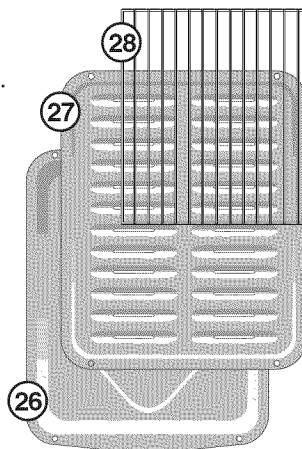
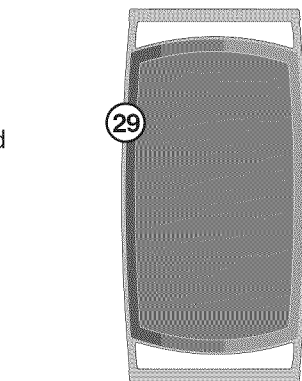
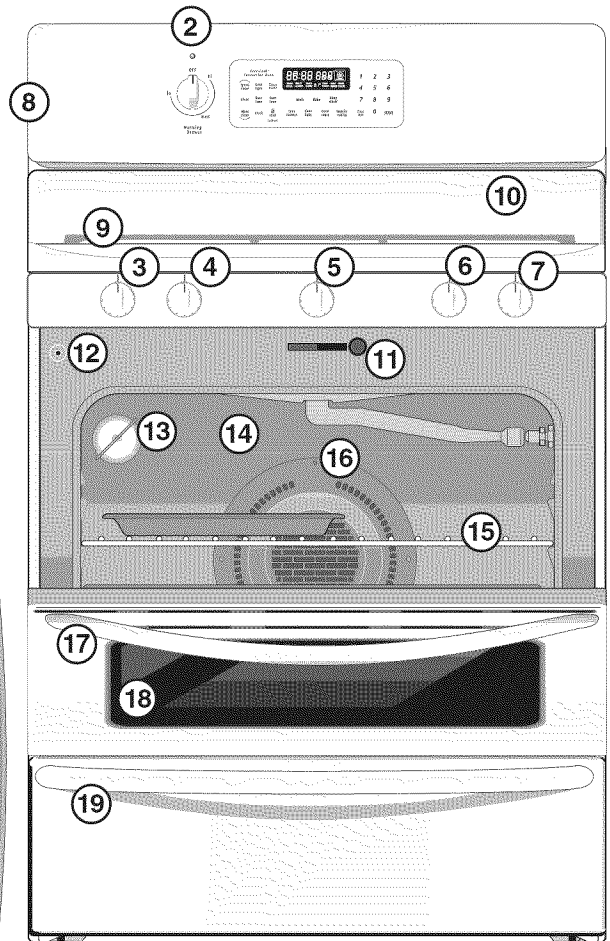

NOTE: The features of your range may vary according to model type & color.



Before Setting Oven Controls

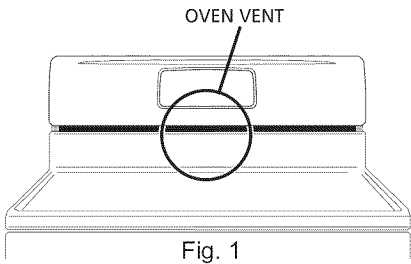

Oven Vent Location

The oven vent is located **below the backguard** (See Fig. 1). When the oven is on, warm air is released through this vent. This venting is necessary for proper air circulation in the oven and good baking results. **DO NOT BLOCK THE VENT.**

Removing & Replacing Oven Racks

To remove, pull the rack forward until it stops. Lift up front of rack and slide out.
To replace, fit the rack onto the guides on the oven walls. Tilt the front of the rack upward and slide the rack back into place.

Oven Racks

Your range is equipped with one or more **Flat Oven Rack(s)**. Place the rack(s) into the positions shown in Fig. 2. Refer to the following *Recommended Rack Positions for Broiling, Baking & Roasting* for complete information.

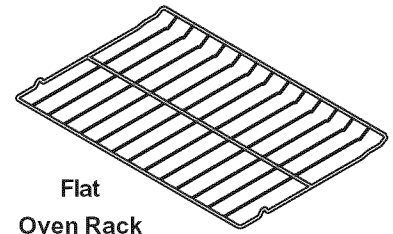

Fig. 2

Arranging Oven Racks

ALWAYS ARRANGE OVEN RACKS WHEN THE OVEN IS COOL (PRIOR TO OPERATING THE OVEN). Always use oven mitts when using the oven.

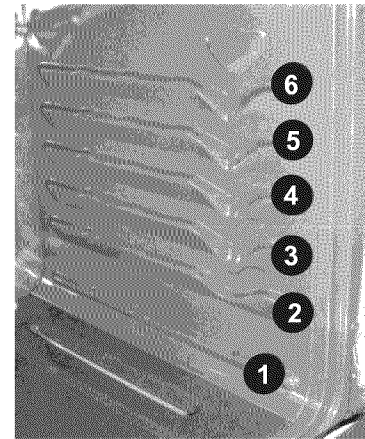

Fig. 3

Recommended Rack Positions for Broiling, Baking & Roasting:

Food	Rack Position
Broiling hamburgers & steaks	See Broil section
Broiling meats, chicken or fish	See Broil section
Cookies, cakes, pies, biscuits & muffins	3 or 4
Frozen pies, angel food cake, yeast, bread, casseroles, small cuts of meat or poultry	1 or 2
Turkey, roast or ham	1 or 2

Baking Layer Cakes with 1 or 2 Oven Racks

For best results when baking cakes using 2 oven racks, place cookware on rack positions 1 & 4 (See Figs. 3 & 4). For best results when using a single oven Flat Rack, place cookware on rack position 2 or 3 (See Figs. 3 & 5).

Air Circulation in the Oven

For best air circulation and baking results allow 2-4" (5-10 cm) around the cookware for proper air circulation and be sure pans and cookware do not touch each other, the oven door, sides or back of the oven cavity. The hot air must be able to circulate around the pans and cookware in the oven for even heat to reach around the food.

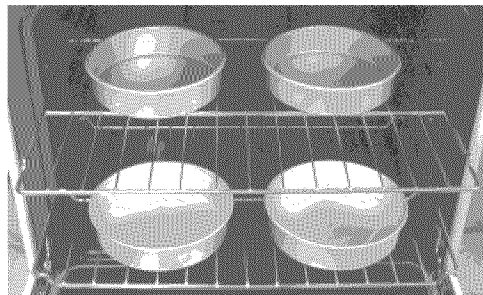

Fig. 4



Fig. 5

Setting Surface Controls



CAUTION Do not place plastic items such as salt and pepper shakers, spoon holders or plastic wrappings on top of the range when it is in use. These items could melt or ignite. Potholders, towels or wood spoons could catch fire if placed too close to a flame.

In the event of an electrical power outage, the surface burners can be lit manually. To light a surface burner, hold a lit match to the burner head, then slowly turn the surface control knob to **LITE**. After burner lights push in and turn knob to desired setting. Use caution when lighting surface burners manually.

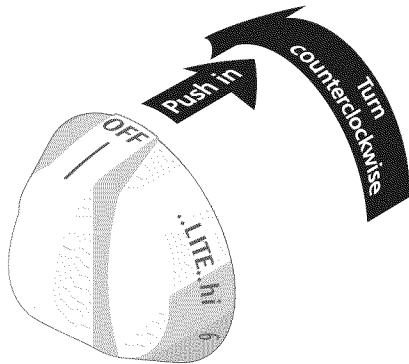

OFF ..LITE.. hi 6 5 4 3 2 lo

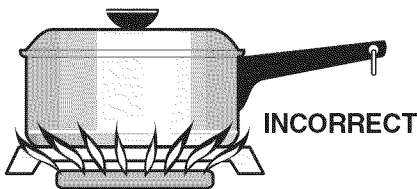
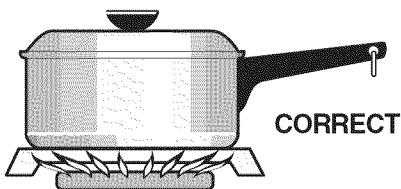

Never extend the flame beyond the outer edge of the utensil. A higher flame simply wastes heat and energy, and increases your risk of being burned by the flame.

Setting Surface Controls

Your range may be equipped with different sized surface burners. The ability to heat food quicker and in larger volumes increases as the burner size increases.

The **SIMMER** burner (some models) is best used for simmering delicate food items such as sauces, etc.

The standard burners can be used for most surface cooking needs. Some models include a standard sized center burner (or 5th burner).

The **POWER PLUS** burner or burners (some models) are best used for bringing large quantities of liquid to temperature and when preparing larger quantities of food.

Regardless of size, always select cookware that is suitable for the amount and type of food being prepared. Select a burner and flame size appropriate to the pan. Never allow flames to extend beyond the outer edge of the pan.

Operating the Gas Surface Burners:

1. Place cooking utensil on surface burner.
2. Push the surface control knob in and turn **counterclockwise** out of the OFF position.
3. Release the knob and rotate to the LITE position. Note: All four electronic surface igniters will spark at the same time. However, only the burner you are turning on will ignite.
3. Visually check that the burner has lit.
4. Push the control knob in and turn **counterclockwise** to the desired flame size. The control knobs do not have to be set at a particular setting. Use the guides and adjust the flame as needed. **DO NOT** cook with the surface control knob in the LITE position. (The electronic ignitor will continue to spark if the knob is left in the LITE position.)

Setting Proper Surface Burner Flame Size

For most cooking, start on the highest control setting and then turn to a lower one to complete the process. Use the recommendations below as a guide for determining proper flame size for various types of cooking. The size and type of utensil used and the amount of food being cooked will influence the setting needed for cooking.

*Flame Size

High Flame
Medium Flame
Low Flame

Type of Cooking

Start most foods; bring water to a boil; pan broiling.
Maintain a slow boil; thicken sauces, gravies; steaming.
Keep foods cooking; poach; stewing.

For deep fat frying, use a thermometer and adjust the surface control knob accordingly. If the fat is too cool, the food will absorb the fat and be greasy. If the fat is too hot, the food will brown so quickly that the center will be undercooked. Do not attempt to deep fat fry too much food at once as the food will neither brown nor cook properly.

*These settings are based on using medium-weight metal or aluminum pans with lids. Settings may vary when using other types of pans. The color of the flame is the key to proper burner adjustment. A good flame is clear, blue and hardly visible in a well-lighted room. Each cone of flame should be steady and sharp. Adjust or clean burner if flame is yellow-orange.



Setting Surface Controls

Care of the Griddle

Before first use:

- Wash Griddle in hot soapy water. Rinse and then dry completely.

After each use:

- Store in a dry place.
- After each use, clean with hot soapy water.
- **THE GRIDDLE IS DISHWASHER SAFE.**
- Dry Immediately before storing.

Using the Griddle:

- Place the griddle centered over the Bridge Burner (some models). For location refer to Fig. 1.
- Preheat the griddle for 5 minutes on medium to medium low setting. Slow preheat ensures even heat distribution during the cooking process.
- **DO NOT** preheat the griddle on HI setting. Preheating on HI may warp the griddle and prevent even heat distribution.

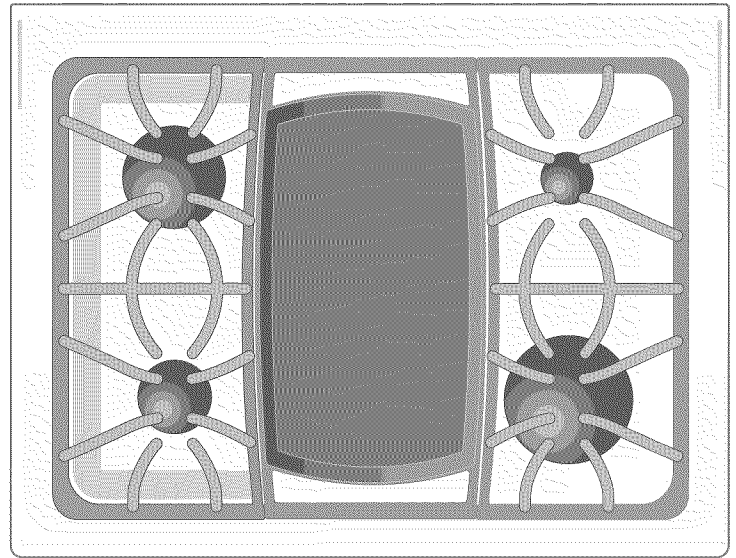

Fig. 1



Setting Warming Drawer Controls (some models)

Arranging Warming Drawer Rack Positions

The rack can be used in 2 ways:

- In the **upright position** to allow low profile food items to be placed both under and on top of the rack (for example, rolls or biscuits on top of the rack and a casserole dish underneath).
- In the **downward position** to allow you to place light weight food items and empty cookware (for example, rolls or pastries and dinner plates) on the rack.

Set the Warming Drawer rack in either position as shown below (Fig. 1).

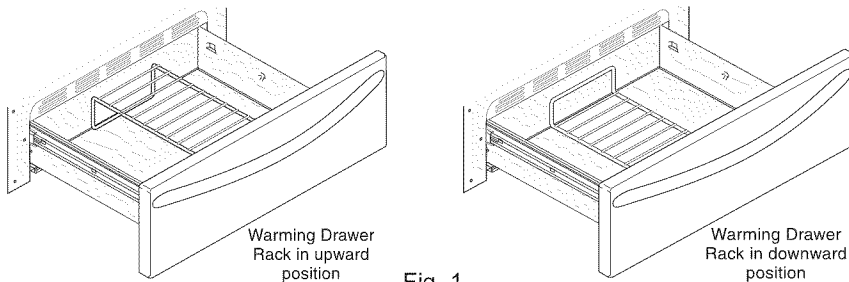
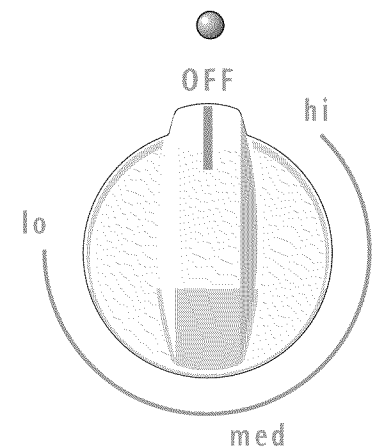

Fig. 1

CAUTION Always use pot holders or oven mitts when removing food from the Warming Drawer as cookware and plates will be hot and you can be burned.



Warming
Drawer

Fig. 2

To Operate the Warming Drawer

The purpose of the Warming Drawer is to keep hot cooked foods at serving temperature. Always start with hot food. It is not recommended to heat cold food in the Warming Drawer.

All food placed in the Warming Drawer should be covered with a lid or aluminum foil to maintain quality. **Do not use plastic wrap to cover food. Plastic may melt onto the drawer and be very difficult to clean.** Use only utensils and cookware recommended for oven use in the Warming Drawer.

Setting Warming Drawer Controls

Removing & Replacing the Warming Drawer



To Set the Warming Drawer Control

The control is used to select the temperature of the Warming Drawer. It is located on the control panel. To set the control, push in and turn the knob to the desired setting. The temperatures are approximate, and are designated by **HI** (high), **MED** (medium) and **LO** (low). To set the Warming Drawer control:

1. Turn the knob to select the desired temperature setting.
2. For best results, preheat the drawer before adding food. An empty drawer will preheat in approximately 15 minutes.
3. When done, turn the control to **OFF**.

Warming Drawer Temperature Selection

Recommended Warming Drawer food settings are shown in Fig. 3. If a particular food is not listed, start with the MED setting. If more crispness is desired, remove the lid or aluminum foil from the food. Most foods can be kept at serving temperatures on the MED setting. When a combination of foods are to be kept warm (for example, a meat with 2 vegetables and rolls) use the HI setting. To avoid heat loss, do not open the Warming Drawer while in use.

Warming Drawer Indicator Light

The Warming Drawer indicator light is located above the Warming Drawer control knob (See Fig. 2). It turns on when the control is set, and stays on until the control is turned off. **The Warming Drawer will not operate during the Self-Clean cycle.**

Warming Drawer Recommended Food Settings Table

Food Item	Setting
Bacon	HI
Hamburger Patties	HI
Poultry	HI
Pork Chops	HI
Fried Foods	HI
Pizza	HI
Gravies	MED
Casseroles	MED
Eggs	MED
Roasts (Beef, Pork, Lamb)	MED
Vegetables	MED
Biscuits	MED
Rolls, hard	MED
Pastries	MED
Rolls (soft)	LO
Empty Dinner Plates	LO

Fig. 3

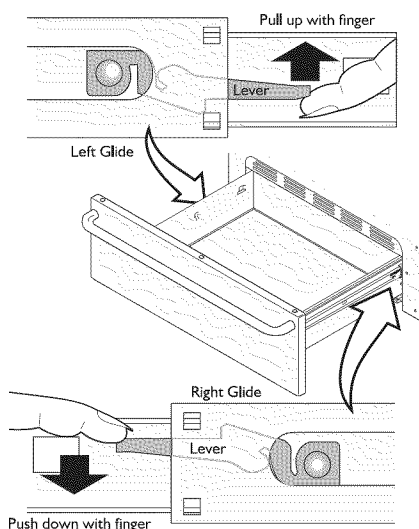

Fig. 1

Fig. 2



! WARNING Electrical Shock Hazard can occur and result in serious injury or death. Disconnect appliance from electric power before cleaning and servicing the Warming Drawer.

To Remove and Replace the Warming Drawer (some models)

To Remove the Warming Drawer:

1. **! CAUTION** Turn power off before removing the Warming Drawer.
2. Open the drawer to the fully opened position.
3. Locate glide lever on each side of drawer, pull up on the left glide lever and push down on the right glide lever (See Fig. 1).
4. Pull the drawer away from the range.

To Replace the Warming Drawer:

1. **Pull the bearing glides to the front** of the chassis glide (See Fig. 2).
2. Align the glide on each side of the drawer with the glide slots on the range.
3. Push the drawer into the range until levers “click” (approximately 2”). Pull the drawer open again to seat bearing glides into position. **If you do not hear the levers “click” or the bearing glides do not feel seated remove the drawer and repeat steps 1 thru 3.** This will minimize possible damage to the bearing glides.

NOTE: The Warming Drawer will **NOT** operate while in the Self-Clean and “Oven Lockout” modes.



Control Pad Features

READ THE INSTRUCTIONS CAREFULLY BEFORE USING THE OVEN. For satisfactory use of your oven, become familiar with the various features and functions of the oven as described below. **Detailed instructions for each feature and function follow later in this Use & Care Guide.**

OVEN LIGHT—Use to turn the oven light ON and OFF.

TIMER ON/OFF—Use to set or cancel the Kitchen Timer.

BROIL—Use to select variable Broil feature.

BAKE—Use to enter the normal Bake feature..

KEEP WARM—Use to select the Keep Warm feature.

0 THRU 9 NUMBER PADS—Use to enter temperature and times.

SPEED CLEAN—Use to select a 2 hour Self-Cleaning cycle.

BAKE TIME—Use to enter the length of the baking time.

CLEAN—Use to select a 3 hour Self-Cleaning cycle.

START TIME—Use with **BAKE, BAKE TIME,** and **CLEAN PADS** to program a Delayed Timed Bake or Delay Self-Cleaning cycle.

MAXX CLEAN—Use to select a 4 hour Self-Cleaning cycle.

CLOCK—Use to set the time of day.

LOCK CONTROLS—Use to enable or disable most oven features.

CONV CONVERT—Use to select the Convection Convert feature.

CONV BAKE—Use to select the Convection Bake feature.

CONV ROAST—Use to select the Convection Roast feature.

FAVORITE SETTING—Use recall stored recipes.

CLEAR/OFF—Use to cancel any oven mode previously entered except the Oven Lockout, Time of Day & Minute Timer. Press **CLEAR/OFF** to stop cooking.

START—Use to start all oven features (not used with Oven Light).

Minimum & Maximum Control Pad Settings

All of the features listed have minimum and maximum time or temperature settings that may be entered into the control. An ENTRY acceptance beep will sound each time a control pad is touched (the Oven Lockout pad is delayed by 3 seconds).

An ENTRY ERROR tone (3 short beeps) will sound if the entry of the temperature or time is below the minimum or above the maximum settings for the feature.

FEATURE	MIN. TEMP. /TIME	MAX. TEMP. /TIME
PREHEAT TEMP.	170°F / 77°C	550°F / 288°C
BAKE TEMP.	170°F / 77°C	550°F / 288°C
BROIL TEMP.	400°F / 205°C	550°F / 288°C
KITCHEN TIMER	12 Hr. 24 Hr.	11:59 Hr. / Min. 11:59 Hr. / Min.
CLOCK TIME	12 Hr. 24 Hr.	12:59 Hr. / Min. 23:59 Hr. / Min.
COOK TIME	12 Hr. 24 Hr.	11:59 Hr. / Min. 23:59 Hr. / Min.
START TIME	12 Hr. 24 Hr.	12:59 Hr. / Min. 23:59 Hr. / Min.
CLEAN TIME	2 hours	4 hours
CONVECTION BAKE	300°F / 149°C	550°F / 288°C

Setting Oven Controls



Setting the Clock







The **CLOCK**  pad is used to set the clock. The clock may be set for 12 or 24 hour time of day operation. The clock has been preset at the factory for the 12 hour operation. When the appliance is first plugged in, or when the power supply to the appliance has been interrupted, the clock in the display will flash (See Fig. 1).



Fig. 1

INSTRUCTIONS

To set the clock (example below for 1:30):

1. Press . "CLO" will appear in the display (See Fig. 2).
2. Press    pads to set the time of day to 1:30 (See Fig. 3). Press . "CLO" will disappear and the clock will start (See Fig. 4).

PRESS

DISPLAY

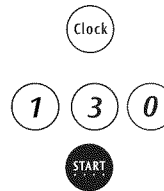

Fig. 2



Fig. 3

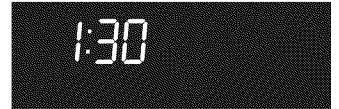





Fig. 4

Changing between 12 or 24 hour time of day display:

1. Press and hold  for 6 seconds until "12h" or "24h" appears in the display.
2. Press  to switch between the 12 and 24 hour time of day display. "12h" or "24h" will be displayed (See Figs. 5 or 6).
3. Press  to accept the desired change or press  to reject the change.
4. Reset the correct time as described in **To set the clock** above. Please note that if the 24 hour time of day mode was chosen, the clock will now display time from 00:00 through 23:59 hours.

 for 6 seconds





Fig. 5



Fig. 6

Setting Silent Control Operation



The **DELAY START**  and **FLEX CLEAN**  pads control the Silent Control operation feature. The Silent Control operation feature allows the oven control to be operated without sounds or beeps whenever necessary. If desired the control can be programmed for silent operation and later returned to operating with all the normal sounds and beeps.

INSTRUCTIONS

PRESS

DISPLAY

To change control from normal sound to silent control operation:

1. To tell if your range is set for normal or silent operation press and hold  for 6 seconds. (See Fig. 7)
2. Press  to switch between normal sound operation and silent operation mode. The display will show either "SP" (See Fig. 8) or "- -" (See Figs. 2 or 3).

 for 7seconds



Fig. 7





Fig. 8



Fig. 9

If "SP" appears (See Fig. 2), the control will operate with normal sounds and beeps. If "- -" appears (See Fig. 9), the control is set for silent operation mode.

3. Press  to accept the change or press  to reject the change.





Setting Oven Controls

Setting Continuous Bake or 12 Hour Energy Saving

The **TIMER ON/OFF** (Timer On/off) and **CLEAN** (Clean) pads control the Continuous Bake or 12 Hour Energy Saving features. The oven control has a factory preset built-in 12 Hour Energy Saving feature that will shut off the oven if the oven control is left on for more than 11 hours and 59 minutes. The oven can be programmed to override this feature for Continuous Baking.

INSTRUCTIONS

To set the control for Continuous Bake or 12 Hour Energy Saving features:

1. Press and hold (Timer On/off) for 6 seconds or until the control beeps once. (Fig.1). "12h" or "- - h" will appear in the display and the control will beep once.
2. Press (Clean) to switch between the 12 Hour Energy Saving and continuous bake features. Note: "12h" (See Fig. 2) in the display indicates the control is set for 12 Hour Energy Saving feature and "- - h" (See Fig. 3) indicates the control is set for the Continuous Bake feature.
3. Press (START) to accept the change (See Fig. 4) display will return to time of day or press (Clear/Off) to reject the change.

PRESS

(Timer On/off) for 6 seconds



DISPLAY



Fig. 1



Fig. 2



Fig. 3



Fig. 4

Setting Kitchen Timer

The **TIMER ON/OFF** (Timer On/off) pad controls the kitchen timer feature. The Timer serves as an extra reminder in the kitchen that will beep when the set time has run out. The Timer will not START or STOP the cooking process. The Timer feature may be used during any of the other oven control functions. Refer to "Minimum & Maximum Control Pad Settings" on page 10 for time amount settings.

INSTRUCTIONS

To set the Timer (example for 5 minutes):

1. Press (Timer On/off). (See Fig. 5).
2. Press the number pads to set the desired time in the display (example (5)). Press (START). The timer will begin a count down. (See Fig. 6).
Note: If (START) is not pressed the timer will return to the time of day.
3. When the set time has run out, the clock will sound with 3 long beeps every 5 seconds until (Timer On/off) is pressed (See Fig. 7).

PRESS



DISPLAY



Fig. 5



Fig. 6



Fig. 7

To cancel the Timer before the set time has run out:

Press (Timer On/off). The display will return to the time of day.

Setting Oven Controls



Setting Oven Lockout Feature

The  pad controls the Oven Lockout feature. The Oven Lockout feature automatically locks the oven door and prevents most oven controls including the Warmer Drawer control (models with a Warmer Drawer) from being turned ON. It does not disable the clock, Kitchen Timer or the interior oven light.

INSTRUCTIONS

PRESS

DISPLAY

To activate the Oven Lockout feature:

1. Press and hold  for 3 seconds.
2. After 3 seconds a beep will sound, **Loc** will appear and **"DOOR LOCKED"** will flash in the display. Once the oven door is locked the **"DOOR LOCKED"** indicator will stop flashing. (See Fig. 1)



 for 3 seconds



Fig. 1

To reactivate normal oven operation:

1. Press and hold  for 3 seconds. A beep will sound. **Loc** will clear. The **"DOOR LOCKED"** will continue to flash until the oven door has completely unlocked (See Fig. 2).
2. The oven is fully operational.



 for 3 seconds



Fig. 2

Setting Temperature Display — Fahrenheit or Celsius





The **BROIL**  and **CLEAN**  pads control the Fahrenheit or Celsius temperature display modes. The oven control can be programmed to display temperatures in Fahrenheit or Celsius. The oven has been preset at the factory to display in Fahrenheit.

INSTRUCTIONS

PRESS

DISPLAY

To change display from Fahrenheit to Celsius or Celsius to Fahrenheit:

1. To tell if the display is set for Fahrenheit or Celsius press  (Fig. 3) and hold for 7 seconds; **"550°"** will first appear in the display and then a beep will sound. If **"F"** appears, the display is set to show temperatures in Fahrenheit (Fig. 4). If **"C"** appears, the display is set to show temperatures in Celsius (Fig. 5).
2. Press  to switch between Fahrenheit or Celsius display modes. The display will show either **"F"** (Fig. 4) or **"C"** (Fig. 5).
3. Press  to accept the change or press  to reject the change.

 for 7seconds



Fig. 3



Fig. 4





 or 



Fig. 5







Setting Oven Controls

Using the Favorite Setting Feature

The  **FAVORITE SETTING** pad is used to record and recall your favorite recipe settings. This feature may store and recall from 1 to 3 different settings. The Favorite Setting feature may be used with **Bake** or a **Timed Bake**. This feature will not work with any other function including a **Delayed Timed Bake** setting.



INSTRUCTIONS

To Program the Oven to record a recipe setting and begin baking (sample shown is for bake at 350°F):



1. Place the food in the oven.
2. Press . (See Fig. 1)
3. Within 5 seconds, press . (Note:  or  may also be used to store a recipe setting -See Fig. 2).
4. Press and hold  pad for at least 3 seconds or until a beep sounds. The beep indicates that the recipe setting has been recorded for future recall (Fig. 3).

NOTE: The oven will continue to bake unless  is pressed.

To Begin Baking recalled setting (example below recalling from the number 1 pad) :

1. Place the food in the oven.
2. Press .
3. Within 5 seconds, press  (Fig. 2).
4. Press  (See Fig. 3). The oven will begin to immediately cook with the previously recorded recipe. The Temperature is recalled and if a Timed Bake was recorded this feature will also recall the cooking time.

To quickly erase all stored recipes:

1. Press and hold the  key pad until the first single beep sounds in 6 seconds (**rst PS** will appear in the oven display).
2. After the first beep press the  key pad once. Any stored recipes will be erased.

Please Note: Clearing the favorites will also reset all other adjustments back to the factory settings. These include **12 or 24 Hour Time of Day display, Continuous Bake or 12 Hour Energy Savingsmode, Silent Control Operation, Fahrenheit or Celsius Temperature Display** and any Oven Temperature adjustments that are set.

PRESS

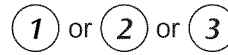

hold  for 3 seconds



DISPLAY



Fig. 1



Fig. 2



Fig. 3

Setting Oven Controls



Some Important Things to Know Before Setting any Basic Oven Cooking Function

This appliance has been factory pre-set to start any **Bake**, **Conv Bake**, or **Conv Roast** functions with the oven set temperature to automatically start at 350°F. However if desired, the oven set temperature may be adjusted at any time during the cooking process. You may also choose to add a **Bake Time** or **Start Time** with any of the functions listed above.

Setting Bake



The **Bake**  pad controls normal baking. The oven can be programmed to bake at any temperature from 170°F to 550°F (The sample shown below is for 350°F).

INSTRUCTIONS

PRESS

DISPLAY

To set the Bake Temperature to 350°F:

1. Arrange interior oven racks and place food in oven.
2. Press , 350° will automatically appear in the display (See Fig. 1).
3. Press . A long beep will sound once the oven set temperature reaches 350° F (See Fig. 2).

Note: Pressing  will cancel the Bake feature at any time.







Fig. 1



Fig. 2



To change the Bake Temperature (example changing from 350° to 425°F):

1. After the oven has already been set to bake at 350°F and the oven set temperature needs to be changed to 425°F, press  (See Fig. 2).
2. Press   . 425° will appear in the display.
3. Press  (See Fig. 3).
4. The oven is now set for 425°F.

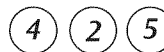



Fig. 3



Setting Oven Controls

Setting Bake Time

The **Bake**  and **Bake Time**  pads control the **Bake Time** feature. The automatic timer of the **Bake Time** feature will turn the oven OFF after cooking for the desired amount of time you select.

INSTRUCTIONS

To program the oven to begin baking immediately and to shut off automatically: (example below to bake at 350°F for 50 minutes):

1. Arrange interior oven rack(s) and place the food in the oven.
2. Press **Bake**  (See Fig. 1).

3. Press **START**  (See Fig. 2).

4. Press **Bake time**  (See Fig.3).

5. Enter the desired baking time by pressing **5** **0**.

Note: Baking time can be set for any amount of time between 1 minute to 11 hours and 59 minutes. (See Fig. 4)

6. Press **START** . (See Fig. 5)

Note: After the **Bake Time** feature has been activated, press **Bake time**  to review the time remaining.

Once this feature has started baking, a long beep will sound when the oven temperature reaches the set temperature.

Press **Clear/Off**  when baking has finished or at any time to cancel the **Bake Time** feature.

When the Bake Time finishes:

1. "End" and the time of day will show in the display. The oven will shut off automatically (See Fig. 6).
2. The control will beep 3 times. The control will continue to beep 3 times every 30 seconds until **Clear/Off**  is pressed.

PRESS



DISPLAY



Fig. 1



Fig. 2



Fig. 3



Fig. 4



Fig. 5





Fig. 6

CAUTION Use caution with the **Bake Time** or delayed **Start Time** functions. Use the **Bake Time** function when cooking cured or frozen meats and most fruits and vegetables. Foods that can easily spoil such as milk, eggs, fish, meat or poultry, should be chilled in the refrigerator first. Even when chilled, they should not stand in the oven for more than 1 hour before cooking begins, and should be removed PROMPTLY when cooking is complete. Eating spoiled food can result in sickness from food poisoning.

Setting Oven Controls

















Setting a delayed Start Time

The **Bake** , **Bake Time**  and **Start Time**  pads control the delayed **Start Time** feature. The automatic timer of the delayed **Start Time** feature will turn the oven ON and OFF at the times you select.

INSTRUCTIONS

To program the oven for a delayed Start Time and to shut off automatically (example for baking at 375°F for 50 minutes and starting at 5:30):

1. Be sure that the clock is set with the correct time of day.
2. Arrange interior oven rack(s) and place the food in the oven.
3. Press  (See Fig. 1)
4. Enter the desired baking time using the number key pads by pressing   (See Fig. 2). Note: Baking time may be set for any amount of time from 1 minute to 11 hours and 59 minutes.
5. Press  (See Fig. 3).
6. Press  (See Fig. 4).
7. Enter the desired start time using the number pads   . (See Fig. 5)
8. Press . (See Fig. 6)
9. Press . (See Fig. 7)
10. Press   .
11. Press . (See Fig. 8)

Note: After the delayed Start Time feature has been activated and started cooking, press  to review the time remaining.

A long beep will sound when the delayed Start Time has started cooking and the oven temperature reaches the set temperature.

Press  when baking has finished or at any time to cancel the delayed **Start Time** feature.

When the delayed Start Time runs out:

1. "End" will show in the display. The oven will shut off automatically (See Fig. 9).
2. The control will beep 3 times. The control will continue to beep 3 times every 30 seconds until  is pressed.

PRESS

DISPLAY



Fig. 1



Fig. 2



Fig. 3



Fig. 4

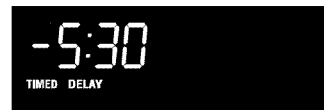

Fig. 5

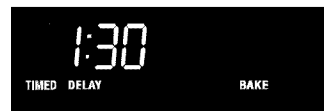

Fig. 6



Fig. 7



Fig. 8



Fig. 9

NOTE: If your clock is set for normal 12 hour display mode the delayed **Start Time** feature can not be set to start more than 12 hours in advance. To set the delayed **Start Time** 12-24 hours in advance see page 11 for instructions to set the control for the 24 hour time of day display mode.



Setting Oven Controls

Setting Broil

The **Broil** pad controls the Broil feature. When broiling, heat radiates downward from the oven broiler for even coverage. The Broil feature is preset to start broiling at 550°F, however, the Broil feature temperature may be set at any temperature between 400°F and 550°F.

DO NOT cover the oven racks with aluminum foil. The exposed grease could catch fire. The broil pan and broil pan insert (optional accessory) used together allows dripping grease to drain and be kept away from the high heat of the oven broiler. **DO NOT** use the broil pan without the insert (See Fig. 5).

INSTRUCTIONS

To set the oven to broil at the default setting (550°F):

1. Place the broiler pan insert on the broiler pan. Then place the food on the broiler pan insert. **DO NOT** use the broiler pan without the insert.
2. Arrange the interior oven rack and place the broiler pan on the rack. Be sure to center the broiler pan directly under the broiler element. **Close the oven door.** Preheat the oven for 5 minutes.
3. Press **Broil**. (See Fig. 1).
4. If a lower broil temperature is desired (minimum broil temperature setting is 400°F), press the desired temperature before continuing to step 5.
5. Press **START**. The oven will begin to broil. "**BROIL**" and "**550°**" will appear in the display (See Fig. 2).
6. Broil on one side until food is browned; turn and cook on the second side. Season and serve. **Note:** Always pull the rack out to the stop position before turning or removing food.
7. To cancel broiling or if finished press **Clear/Off** (See Fig. 3).

PRESS



DISPLAY



Fig. 1



Fig. 2



Fig. 3

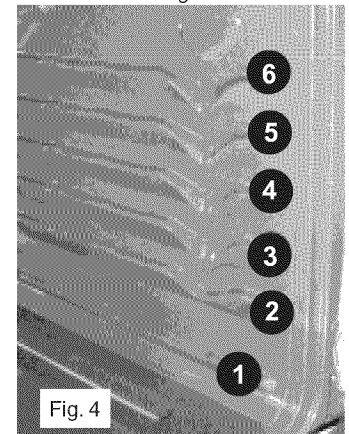

Fig. 4

Broiling Times /Searing Grill (optional accessory)

Use the following table for approximate broiling times. Increase or decrease broiling times, or move the broiling pan to a different rack position to suit for doneness. If the food you are broiling is not listed in the table, follow the instructions provided in your cookbook and watch the item closely. Use the Searing Grill for meats and steaks if desired. Before placing the meat, be sure to heat the Searing Grill using Broil for 10 minutes. Cook times should be reduced 1-2 minutes per side when cooking with the Searing Grill. Place Searing Grill on top of Broiler Pan and insert for meats and steaks (Fig. 6).

Broiling Table (Refer to Fig. 4)

Food Item	Rack Position	Temp Setting	Cook Time		Doneness
			1st side	2nd side	
Steak 1" thick	5th or 6th	550° F	8:00	6:00	Medium
	5th or 6th	550° F	10:00	8:00	Medium-Well
Pork Chops 3/4" thick	5th	550° F	12:00	8:00	Well
Chicken - Bone In	4th	450° F	25:00	15:00	Well
Chicken - Boneless	5th	450° F	10:00	8:00	Well
Fish	5th	500° F	as directed	as directed	Well
Shrimp	4th	550° F	as directed	as directed	Well
Hamburger 3/4" thick	6th	550° F	12:00	10:00	Well
	5th	550° F	14:00	12:00	Well

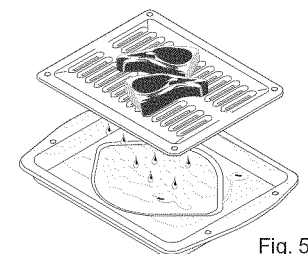

Fig. 5

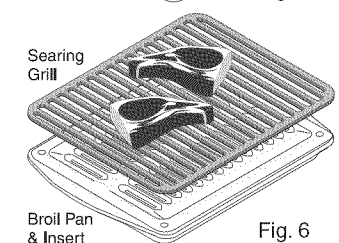

Fig. 6

⚠ WARNING Should an oven fire occur, leave the oven door closed and turn the oven OFF. If the fire continues, throw baking soda on the fire or use a fire extinguisher. **DO NOT** put water or flour on the fire. Flour may be explosive and water can cause a grease fire to spread and cause personal injury.

Setting Oven Controls



Benefits of Convection Bake:

- Multiple oven rack baking.
- No special pans or bakeware needed.

Setting Convection Bake

The **Conv Bake**  pad controls the **Convection Bake** feature.

Use the **Convection Bake** feature when cooking speed is desired. The oven may be programmed for **Convection Bake** at any temperature between 300°F (149° C) to 550° F (288° C).

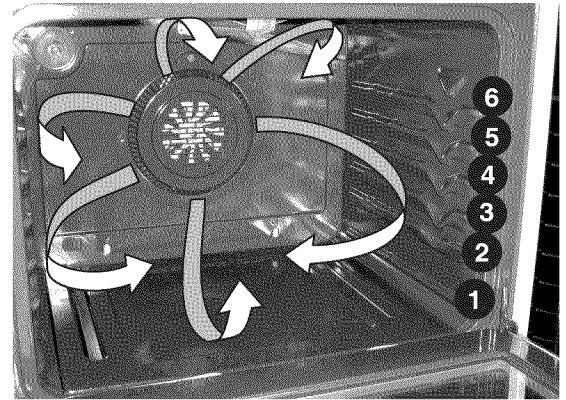

Air circulation of Convection Cooking

Fig. 1

Convection baking uses a fan to circulate the oven's heat evenly and continuously within the oven (See Fig. 1). This improved heat distribution allows for even cooking and excellent results using multiple racks at the same time. Foods cooked on a single oven rack will generally cook faster and more evenly with **Convection Bake**. Multiple oven rack cooking may slightly increase cook times for some foods, but the overall result is time saved. **Breads** and pastries brown more evenly.

Tips for Convection Bake

1. Time reductions will vary depending on the amount and type of food to be cooked. Cookies and biscuits should be baked on pans with no sides or very low sides to allow heated air to circulate around the food. Food baked on pans with a dark finish will cook faster.
2. Preheating is not necessary when cooking casseroles with **Convection Bake**.
3. When using **Convection Bake** with a single rack, place oven rack in position 3 or 4. If cooking on multiple racks, place the oven racks in positions 1 and 4 when using 2 racks. When using 3 racks, place in positions 1, 3 & 5 when using 3 racks (See Fig.1).

INSTRUCTIONS

PRESS

DISPLAY

To set the oven for Convection Bake and temperature to 350°F:

1. Arrange interior oven racks and place food in oven (See Fig. 1).

2. Press  (See Fig. 2).

3. Press .

Note: Please allow the convection fan **6 minutes** to activate. When the convection fan activates, a rotating fan icon will appear in the display (See Fig. 3). The oven icon will show a rotating fan within the square. This rotating fan icon indicates when the Convection Fan is operating.

Press  to stop **Convection Bake** or cancel **Convection Bake** at any time.



Fig. 2



Fig. 3



Setting Oven Controls

To set the Convection Convert feature

The  **Conv Convert** pad is used to automatically convert a **standard baking** recipe for convection baking. When set properly, this feature is designed to display the set oven temperature converted (reduced) in the display.



Convection Convert **MUST** be used with a **Conv Bake**  keypad. **Bake Time** or **Start Time** functions may be added.

INSTRUCTIONS

PRESS

DISPLAY

Using Convection Convert feature to adjust oven temperature from a bake recipe (example below when setting oven for 350°F):

1. Arrange interior oven racks and place food in oven.
2. Press , (See Fig. 1). If a **Bake Time** or a **delayed Start Time** is desired, enter the times now.
3. Press . "**CONV BAKE**" and the oven set temperature **adjustment** will appear in the display (for this example it is 325°F). A beep will sound once the **adjusted** oven set temperature is reached. (See Fig. 2).

Please allow the convection fan **6 minutes** to activate. When the convection fan activates, a rotating fan icon will appear in the display (See Fig. 2). The oven icon will show a rotating fan within the square. This rotating fan icon indicates when the Convection Fan is operating.

Note: When used with a **Bake Time** or a **delayed Start Time** setting, the **Convection Convert** feature will display a "**CF**" for check food when the bake time is 75% complete (See Fig. 3). At this time the oven control will sound 3 long beeps at regular intervals until baking has finished. When the bake time has completely finished the control will display "**End**" and will sound 3 long beeps every 30 seconds until the  pad is pressed (Fig.4).

Press  to stop **Convection Bake** or cancel **Convection Bake** at any time.

Note: The minimum amount of cook time using the Convection Convert feature with a **Bake Time** or a **delayed Start Time** function is 20 minutes.



Fig. 1



Fig. 2



Fig. 3



Fig. 4



Setting Oven Controls



Benefits of Convection Roast:



- Some foods cook up to 25 to 30% faster, saving time and energy.
- Multiple oven rack baking.
- No special pans or bakeware needed.

Setting Convection Roast

The **Conv Roast**  pad sets the **Convection Roast** feature. The **Conv Roast** feature combines a cook cycle with the convection fan and element to roast meats and poultry. Heated air circulates around the food from all sides, sealing in juices and flavors. Foods are crispy brown on the outside while staying moist on the inside. Preheating is not necessary for meats and poultry.

INSTRUCTIONS

To set the Convection Roast feature (example for meats to cook at 350°F):

1. Arrange interior oven racks and place food in oven.
2. Press . (See Fig. 1).
3. Press . (See Fig. 2).

Press  to stop Convection Roast at any time.

Note: Please allow the convection fan **6 minutes** to activate. When the convection fan activates, a rotating fan icon will appear in the display (See Fig. 2).

Roasting Rack Instructions (optional accessories)

When preparing meats for convection roasting, use the broiler pan and insert along with the roasting rack (some models). The broiler pan will catch grease spills and the insert will help prevent grease splatters. The roasting rack (some models) will allow the heat to circulate around the around the meat.

1. Place oven rack on bottom or next to the bottom rack position. See Arranging Oven Racks in the **Before Setting Oven** heated air to circulate under the food for even cooking and helps to increase browning on the underside. Make sure the roasting rack is securely seated on the insert in the broiler pan. **DO NOT** use the broiler pan without the insert. **DO NOT** cover the insert with aluminum foil.
3. Position food (fat side up) on the roasting rack (See Fig. 3).
4. Place the broiler pan on the oven rack.

⚠ WARNING To prevent food from contacting the broil element and to prevent grease splattering, **DO NOT** use the roasting rack when broiling.

PRESS



DISPLAY



Fig. 1



Fig. 2

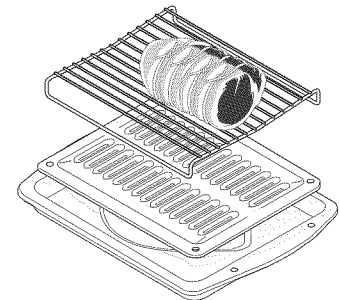

Fig. 3



Setting Oven Controls



To Set the Sabbath Feature (for use on the Jewish Sabbath & Holidays)

The **Bake Time** and **Start Time** pads are used to set the Sabbath feature. The Sabbath feature may only be used with the **Bake** feature. The oven temperature may be set higher or lower after setting the Sabbath feature (the oven temperature adjustment feature should be used only during Jewish Holidays), however the display will not visibly show and no audible tones will be provided when a change occurs. Once the oven is properly set using **Bake** with the Sabbath feature active, the oven will remain continuously ON until cancelled. This will override the factory preset 12-Hour Energy Saving feature. If the oven light is needed during the Sabbath, press before activating the Sabbath feature. Once the oven light is turned ON and the Sabbath feature is active, the oven light will remain ON until the Sabbath feature is turned OFF. If the oven light needs to be OFF, be sure to turn the oven light OFF before activating the Sabbath feature.

IMPORTANT NOTES: It is not advised to attempt to activate any other program feature except **BAKE** while the Sabbath feature is active. ONLY the following key pads will function correctly with the Sabbath feature: **0-9 number pads**, , & . **ALL OTHER KEYPADS** should not be used once the Sabbath feature is activated.

INSTRUCTIONS

PRESS

DISPLAY

To Program the Oven for 350°F, begin Baking Immediately and activate the Sabbath feature:

1. Be sure that the clock is set with the correct time of day.
2. Arrange the oven racks and place the food in the oven.
3. Press , "350°F" will appear in the display (See Fig. 1).
4. Press . The oven will turn ON and begin heating (See Fig. 2).
5. If a **Bake Time** or **Start Time** is needed then enter the times in this step. If not, skip this step and continue to step 6. Refer to the **Bake Time** or delayed **Start Time** instructions on pages 16-20. Remember the oven will shut down after completing a **Bake Time** or delayed **Start Time** and therefore may only be used once during the Sabbath/Jewish Holidays. The maximum delayed **Start Time** is 11 hours & 59 minutes.



Fig. 1

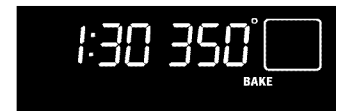
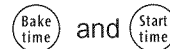

Fig. 2



Fig. 3

6. At the same time press and hold both the and pads for at least 3 seconds. The control will beep and **SAAb** will appear in the display (See Fig. 3). Once **SAAb** appears in the display the oven control will no longer beep or display any further changes and the oven is properly set for the Sabbath feature.



Note: You may change the oven temperature once baking has started. Press , enter the oven temperature change (170 to 550F°) and press (for Jewish Holidays only). Remember that **the oven control will no longer beep or display any further changes** once the oven is set for the Sabbath feature.

7. The oven may be turned OFF at any time by pressing pad (this will turn the oven OFF only). To turn OFF the Sabbath feature press and hold at the same time both the and pads for at least 3 seconds. **SAAb** will disappear from the display.



Setting Oven Controls



To Set the Sabbath Feature (cont'd)



It is recommended that any oven temperature change with the Sabbath feature activated be followed with 2 presses of the **START** pad. This will insure the oven remains ON even if the attempt to set the oven temperature was lower or higher than the oven control can accept. If the oven temperature is set incorrectly, the oven temperature will default to 170°F or 550°F. Try to set the desired oven temperature again.

Should you experience a power failure or interruption, the oven will shut off. When power is returned the oven will not turn back on automatically. The oven will remember that it is set for the Sabbath and the food may be safely removed from the oven while still in the Sabbath feature, however the oven cannot be turned back on until after the Sabbath/Holidays. After the Sabbath observance turn OFF the Sabbath feature. At the same time press and hold both the  and  pads for at least 3 seconds. **SAb** will disappear from the display and the oven may be used with all normal functions. For further assistance, guidelines for proper usage, and a complete list of models with the Sabbath feature, please visit the web at <http://www.star-k.org>.

To turn ON/OFF the Oven Light

The oven light automatically turns ON when the door is opened. The oven light may also be manually turned ON or OFF by pressing the  pad.



Setting Oven Controls

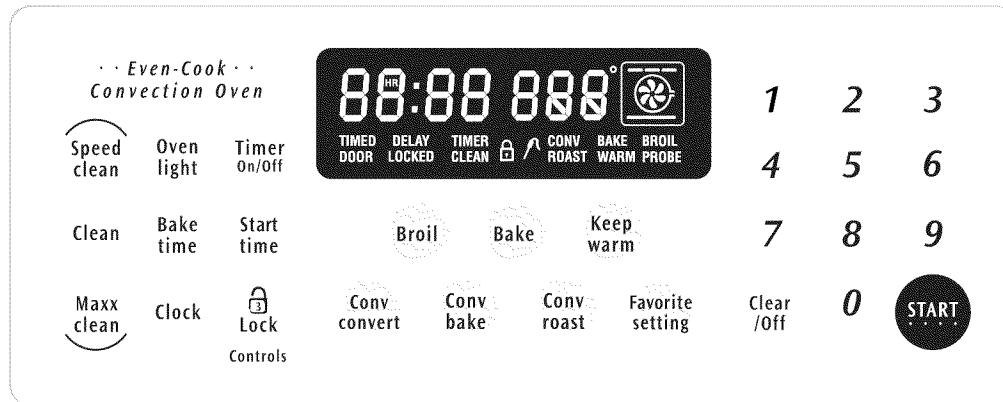

Setting the Keep Warm Feature

The **Keep warm** pad turns ON the **Keep Warm** feature and will maintain an oven temperature of 170° F. The **Keep Warm** feature will shut the oven OFF automatically. The **Keep Warm** feature may be used without any other cooking operations or may also be used after cooking has finished using **Start Time** or delayed **Start Time** functions.

INSTRUCTIONS

PRESS

To set Keep Warm:

1. Arrange interior oven racks and place baked food in oven. If the food is already in the oven go to step 2.
2. Press **Keep warm**.
Note: If no further pads are touched within 25 seconds the request to turn ON **Keep Warm** will be cleared.
3. Press **START**.
4. To turn the **Keep Warm** OFF at any time press **Clear /off**. Note: The **Keep Warm** feature will automatically turn OFF after 3 hours.



To set Keep Warm to turn ON automatically:

1. Arrange interior oven racks and place food in oven. Set the oven properly for **Bake Time** or delayed **Start Time**.
2. Press **Keep warm**.
Note: If no further pads are touched within 25 seconds the request to turn ON **Keep Warm** will be cleared.
3. Press **START**.
4. To turn the **Keep Warm** OFF at any time press **Clear /off**. Note: The **Keep Warm** feature will automatically turn OFF after 3 hours.



Pressing **Clear /off** at any time will stop all oven baking operations.



Self-Cleaning

Clean

Self-Cleaning Oven

A Self-Cleaning oven cleans itself with high temperatures (well above cooking temperatures) which eliminate soils completely or reduces them to a fine powdered ash you can wipe away with a damp cloth.

Adhere to the following cleaning precautions:

- **DO NOT** use oven cleaners or oven protective coatings in or around any part of the Self-Cleaning oven.
- **DO NOT** clean the oven door gasket. The woven material of the oven door gasket is essential for a good seal. Care should be taken not to rub, damage or remove the gasket.
- **DO NOT** use any cleaning materials on the oven door gasket. Doing so could cause damage.
- **Remove the broiler pan and insert, all utensils and any aluminum foil. These items cannot withstand high cleaning temperatures.**
- Porcelain Oven racks do not have to be removed. After the cycle is complete and the oven has cooled, rub the sides of the oven racks with wax paper or a cloth containing a small amount of vegetable oil (this will make the racks glide easier into the rack position).
- **Remove any excessive spillovers** in the oven cavity **before** starting the Self-Cleaning cycle. To clean, use hot, soapy water and a cloth. Large spillovers can cause heavy smoke or fire when subjected to high temperatures. **DO NOT** allow food spills with a high sugar or acid content (such as milk, tomatoes, sauerkraut, fruit juices or pie filling) to remain on the surface as they may leave a dull spot even after cleaning.
- Clean any soil from the oven frame, the door liner outside the oven door gasket and the small area at the front center of the oven bottom. These areas heat sufficiently to burn soil on. Clean with soap and water.

NOTE: Prior to setting the Self-Clean cycle, any spills remaining on the oven bottom should be removed.

IMPORTANT NOTES when using the Self-Clean feature:

1. A Self-Clean cycle cannot be started if **Oven Lockout** feature is active.
2. If a Self-Cleaning-Cycle has started but not finished and a power failure occurs, the appliance may be thoroughly cleaned. After the door unlocks and power has been restored, set for another Self-Clean cycle.
3. If your clock is set for normal 12 hour display mode the delayed Self-Clean cycle can never be set to start more than 12 hours in advance. To set for a delayed Self-Clean cycle 12-24 hours in advance see page 11 for instructions to set the control for the **24 hour time of day** display mode.

CAUTION During the Self-Cleaning cycle, the outside of the range can become very hot to the touch. **DO NOT** leave small children unattended near the appliance.

CAUTION The health of some birds is extremely sensitive to the fumes given off during the Self-Cleaning cycle of any range. Move birds to another well-ventilated room.

CAUTION DO NOT line the oven walls, racks, bottom or any other part of the range with **aluminum foil**. Doing so will destroy heat distribution, produce poor baking results and cause permanent damage to the oven interior (aluminum foil will melt to the interior surface of the oven).

CAUTION DO NOT force the oven door open. This can damage the automatic door locking system. Use caution when opening the door after the Self-Cleaning cycle is completed. The oven may still be **VERY HOT**.

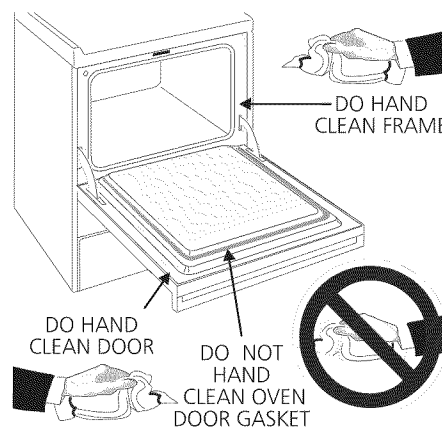

Note: See additional cleaning information for the oven door in the **General Care & Cleaning** section.



Self-Cleaning

Setting Self-Clean

The **Speed Clean** (Speed clean), **Clean** (Clean) & **Maxx Clean** (Maxx clean) pads are used to start a Self-Cleaning cycle. When used with **Start Time** (Start time) pad, a delayed Self-Cleaning cycle may also be programmed. This feature allows for any Self-Cleaning cycle times from 2 hours (using Speed Clean), 3 hours (using Clean) to 4 hours (using Maxx Clean).

WARNING During the Self-Cleaning cycle, the outside of the range can become very hot to the touch. **DO NOT** leave small children unattended near the appliance.

CAUTION **DO NOT** force the oven door open. This can damage the automatic door locking system. Use care when opening the oven door after the Self-Cleaning cycle. Stand to the side of the oven when opening the door to allow hot air or steam to escape. The oven may still be **VERY HOT**.

INSTRUCTIONS

To start an immediate Self-Cleaning cycle or to set a Delay Start time of 9:00 o'clock and shut-off automatically (example provided is a default 3 hour Self-Clean cycle):

1. Be sure the clock is set with the correct time of day, the oven is EMPTY and the oven door is closed.
2. Press (Clean). "CLEAN" will flash and "3:00" (hours) will show in the display (See Fig. 1). Note: 2 hours of Self-Cleaning time may be chosen by pressing (Speed clean) or 4 hours by pressing the (Maxx clean) at this time. You may also skip the other time options and accept the default cleaning time of 3 hours by pressing the Start key pad (See Step 3).
3. Press (START). The "DOOR LOCKED" icon will flash; "CLEAN", "CLn" will remain on in the display (See Fig. 2).
4. As soon as the control is set, the motor driven oven door lock will begin to close automatically. Once the door has been locked the "DOOR LOCKED" indicator light will quit flashing and remain on (Fig. 3).

PRESS

DISPLAY

(Clean) or (Speed clean), (Maxx clean) optional.



Fig. 1



Fig. 2



Fig. 3

NOTE: If the optional delayed Self-Clean feature is needed, finish steps 5-7. If Self-Clean is started immediately skip the remaining steps and continue with "When the Self-Clean cycle is done" on the following page.

5. Press (Start time) (See Fig. 4). Enter the desired Self-Clean starting time using the number pads (9)(0)(0) (See Fig. 5).
6. Press (START). "CLn" icon will turn off; "DELAY", "DOOR LOCKED", and "CLEAN" icons will remain on.
7. The control will calculate forward from the set start time to determine when the Self-Cleaning cycle should end. The Self-Cleaning cycle will turn on automatically at the set time. At that time the icon "DELAY" will go out; the oven icon will come on, the start time. "CLEAN" and "CLn" will remain in the display (See Fig. 6).

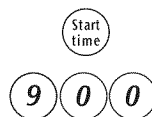

Fig. 4



Fig. 5



Fig. 6

Self-Cleaning



When the Self-Clean cycle is done:

1. The time of day, "HOT", "DOOR LOCKED" and "CLEAN" icon will remain in the display (See Fig. 7).
2. Once the oven has cooled down for approximately 1 HOUR, and the "DOOR LOCKED" icon is no longer displayed, the oven door can then be opened.



Fig.7

Stopping or Interrupting a Self-Cleaning cycle:

If it becomes necessary to stop or interrupt a Self-Cleaning cycle due to excessive smoke or fire in the oven:

1. Press .
2. Once the oven has cooled down for approximately 1 HOUR and the "DOOR LOCKED" icon is no longer displayed, the oven door can then be opened (See Fig. 8).



Fig.8



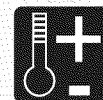

Adjusting Your Oven Temperature









The temperature in the oven has been pre-set at the factory. When first using the oven, be sure to follow recipe times and temperatures. If you think the oven is too hot or too cool, the temperature in the oven can be adjusted. Before adjusting, test a recipe by using a temperature setting that is higher or lower than the recommended temperature. The baking results should help you to decide how much of an adjustment is needed.

INSTRUCTIONS

To adjust the oven temperature higher:

1. Press  for 6 seconds (Fig. 1).
2. To increase the temperature use the number pads to enter the desired change. (Example 30°F)   (Fig. 2). The temperature may be increased as much as 35°F (19°C).
3. Press  to accept the temperature change and the display will return to the time of day (Fig. 3). Press  to reject the change if necessary.

To adjust the oven temperature lower:

1. Press  for 6 seconds (Fig. 4).
2. To decrease the temperature use the number pads to enter the desired change. (Example -30°F)   and then press  (Fig. 5). The temperature may be decreased as much as 35°F (19°C).
3. Press  to accept the temperature change and the display will return to the time of day (Fig. 6). Press  to reject the change if necessary.

PRESS



DISPLAY



Fig. 1



Fig. 2



Fig. 3



Fig. 4



Fig. 5



Fig. 6

Note: The oven temperature adjustments made with this feature will not change the Self-Clean cycle temperature.



General Care & Cleaning

(Cleaning Table)

Surfaces	How to Clean
Glass, Painted Plastic Body Parts & Control Knobs	<p>For general cleaning, use a soft cloth, clean with mild dish detergent & water or a 50/50 solution of vinegar & water. Follow by rinsing the area with clean water; dry & polish with a soft cloth. Glass cleaners may be used if sprayed on a soft cloth 1st. DO NOT spray liquids directly on the control pad and display areas. DO NOT use large amounts of water on the control panel - excess water on the control area may cause damage to the appliance. DO NOT use other liquid cleaners, abrasive cleaners, scouring pads, or some paper towels - they will damage the finish.</p>
Painted Control Panels & Display areas	<p>Before cleaning the control panel, turn all controls to OFF & remove the control knobs. To remove, pull each knob straight off the shaft. Use the <i>general cleaning</i> instructions provided in the paragraph above.</p>
Porcelain Enamel Burner Grates, Cooktop Surface, Below Cooktop, Broiler Pan & Insert, Broiler Drawer, Door Liner & Oven Bottom	<p>Clean burner grates, broiler pan & insert in the dishwasher and dry upon removal. If soils are not removed, follow the cooktop cleaning instructions below.</p> <p>Gentle scouring with a soapy scouring pad will remove most spots. Rinse with a 1:1 solution of clean water & ammonia. <i>If necessary</i>, cover difficult spots with an ammonia-soaked paper towel for 30 to 40 minutes. Rinse with clean water and a damp cloth, then scrub with a soap-filled scouring pad. Rinse & wipe dry with a clean cloth. Remove all cleaners or the porcelain may become damaged during future heating. DO NOT use spray oven cleaners on the range top.</p>
Oven Racks	<p>Remove racks. See "Removing & Replacing Oven Racks" under Before Setting Oven Controls. Use a mild, abrasive cleaner, following the cleaner's recommendations. Rinse with clean water & let dry. After cleaning the racks, rub the sides of the racks with wax paper or a cloth containing a small amount of salad oil (this will make the racks glide easier into the oven rack positions).</p>
Oven Door	<p>Use soap & water to thoroughly clean the top, sides & front of the oven door. Rinse well. You may use a glass cleaner on the outside glass of the oven door. DO NOT immerse the door in water. DO NOT spray or allow water or the glass cleaner to enter the door vents. DO NOT use oven cleaners, cleaning powders or any harsh abrasive cleaning materials on the outside of the oven door. DO NOT clean the oven door gasket. The oven door gasket is made of a woven material, on Self-Cleaning models, which is essential for a good seal. Care should be taken not to rub, damage or remove this gasket.</p>
Stainless Steel	<p>Clean stainless steel with hot soapy water & a dishcloth. Rinse with clean water and a cloth. DO NOT use cleaners with high concentrations of chlorides or chlorines. DO NOT use harsh scrubbing cleaners. Only use kitchen cleaners that are especially made for cleaning stainless steel. Always be sure to rinse the cleaners from the surface as bluish stains may occur during heating that cannot be removed.</p>
Gas Cooktop and Surface Burners	<p>The cooktop is designed to make cleaning easier. Because the burners are sealed, cleanups are easy when spillovers are cleaned up immediately. To clean, wipe with a clean, damp cloth and wipe dry. For more information about cleaning the gas burners see Cleaning the Contoured Cooktop Well Areas, Burner Cap, Burner Head and Burner Drip Pans in the General Care & Cleaning section.</p>



General Care & Cleaning

Cleaning the Cooktop

The cooktop is designed to make cleaning easier. Since the four burners are sealed, cleanups are easy when spillovers are cleaned up immediately. To clean, wipe with a clean, damp cloth and wipe dry. **DO NOT** attempt to clean the cooktop when the cooktop or burner heads are still hot. The contoured well areas and burner drip pans (some models) should be routinely cleaned. Keeping the burner head ports and slots clean will prevent improper ignition and an uneven flame. Refer to the following sections for further instructions.

CAUTION **DO NOT** attempt to clean the cooktop when the cooktop or burner heads are still hot. Touching hot cooktop areas, burner grates and burner caps can cause burns.

CAUTION Any additions, changes or conversions required in order for this appliance to satisfactorily meet the application needs must be made by an authorized **Electrolux** Distributor or Qualified Agency.

To clean the burner head ignition ports - Each burner head has a small ignition port located as illustrated. Should you experience ignition problems it may be that this port hole is partially blocked with soil. With the burner head in place, use a small wire gauge needle or the end of a paper clip to clear the ignition port.

To Clean the Surface Burner Heads - For proper gas flow it may be necessary to clean the burner head and slots. To clean, first use a clean **DAMP** cloth to soak up any spills. Remove any food from between the burner slots using a small non-abrasive brush like a toothbrush and afterwards wipe up using a damp cloth. For stubborn soils located in the slots, use a small-gauge wire or needle to clean the slots.

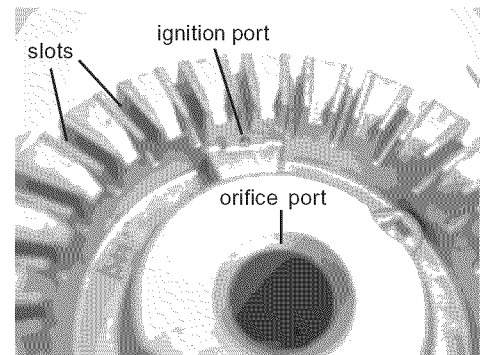

Cooktop Burner Head

Please Note: The surface burner heads are secured to the cooktop and must be cleaned in place on the cooktop.

For proper flow of gas and ignition of the burner — **DO NOT ALLOW SPILLS, FOOD, CLEANING AGENTS OR ANY OTHER MATERIAL TO ENTER THE GAS ORIFICE HOLDER OPENING.** **ALWAYS** keep the surface burner cap and surface burner head in place whenever a surface burner is in use.

To Clean the Recessed and Contoured Well Areas of the Cooktop - If a spill occurs on or in the recessed or contoured areas, blot up spill with an absorbent cloth. Rinse with a clean, damp cloth and wipe dry.

To Clean the Surface Burner Grates, Caps & Surface Burner Drip Pans (some models) - Use a soap-filled scouring pad or a mild abrasive cleanser to clean the surface burner caps and surface burner drip pans (if equipped).

Please Note: **THE COOKTOP IS NOT REMOVABLE.** Do not attempt to remove or lift the cooktop.



General Care & Cleaning

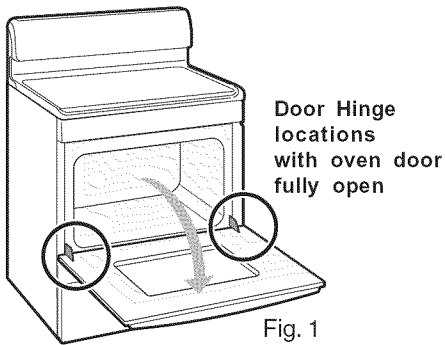

Fig. 1

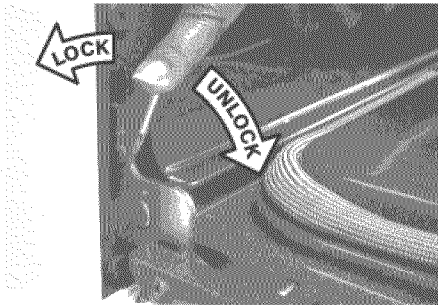

Fig. 2

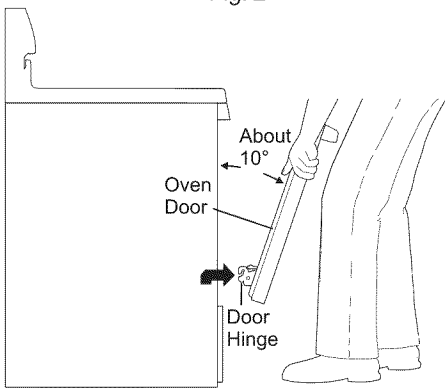

Fig. 3

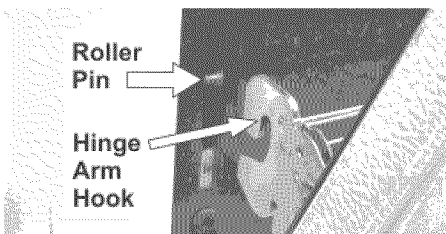

Fig. 4

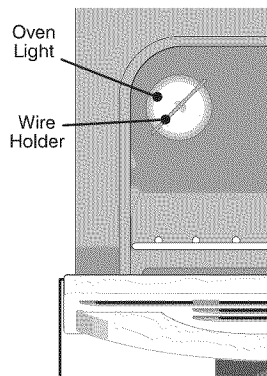

Fig. 5

Removing and Replacing the Lift-Off Oven Door

CAUTION The door is heavy. For safe, temporary storage, lay the door flat with the inside of the door facing down.

To Remove Oven Door:

1. Open oven door completely (horizontal with floor - See Fig. 1).
2. Pull the door hinge locks on both left and right door hinges down from the oven frame completely towards the oven door (See Fig. 2). A tool such as a small flat-blade screwdriver may be required.
3. Firmly grasp both sides of oven door along the door sides (Do not use the oven door handle - See Fig. 3).
4. Close the door to the broil stop position (the oven door will stop into this position just before fully closing).
5. With the oven door in the broil stop position, lift the oven door hinge arms over the roller pins located on each side of the oven frame (See Fig. 4).

To Replace Oven Door:

1. Firmly grasp both sides of oven door along the door sides (Do not use the oven door handle - See Fig. 3).
2. Holding the oven door at the same angle as the removal position, seat the hook of the hinge arm over the roller pins located on each side of the oven door frame (See Fig. 4). The hook of the hinge arms must be fully seated onto the roller pins.
3. Fully open the oven door (horizontal with floor - See Fig. 1).
4. Push the door hinge locks up towards and into the oven frame on both left and right oven door hinges (See Fig. 2) to the locked position.
5. Close the oven door.

Special Door Care Instructions

Most oven doors contain glass that can break. Read the following recommendations:

1. Do not close the oven door until all the oven racks are fully in place.
2. Do not hit the glass with pots, pans, or any other object.
3. Scratching, hitting, jarring or stressing the glass may weaken its structure causing an increased risk of breakage at a later time.

Changing the Oven Light

The oven light automatically turns ON when the door is opened. The oven light may also be manually operated by pressing the  pad. The oven light bulb is located at the rear of the oven and is covered with a glass shield held by a wire holder (See Fig. 5). The glass shield must be in place whenever the oven is in use.

To replace the oven light bulb:

1. Turn electrical power off at the main source or unplug the range.
2. Press wire holder to one side to release the glass shield.
3. Replace bulb with a new 40 watt appliance bulb.
4. Replace glass shield over bulb and snap wire holder into place.
5. Turn power back on again at the main source (or plug the range back in).
6. The clock will then need to be reset. To reset, see **Setting the Clock and Minute Timer** in this Use & Care Guide.

CAUTION Be sure the range is unplugged and all parts are COOL before replacing oven light. Wear a leather-faced glove for protection against possible broken glass.

Before You Call

Solutions to Common Problems



Before you call for service, review the following list. It may save you time & expense. The list includes common occurrences (shown in bold) that are not the result of defective workmanship or materials in this appliance. The possible corrections to these problems are provided with the problem listed:

Range is not level - (1) Poor installation. Place oven rack in center of oven. Place a level on the oven rack. Adjust leveling legs at base of range until the oven rack is level. (2) Be sure floor is level, strong & stable enough to adequately support range. (3) If floor is sagging or sloping, contact a carpenter to correct the situation. (4) Kitchen cabinet alignment may make range appear not level. Be sure cabinets are square & have sufficient room for range clearance.

Cannot move appliance easily. Appliance must be accessible for service - (1) Cabinets not square or are built in too tightly. Contact builder or installer to make appliance accessible. (2) Carpet interferes with range. Provide sufficient space so range can be lifted over carpet.

Surface Burners do not light - (1) Surface Control knob was not completely turned to LITE. Push in & turn the Surface Control knob to LITE until burner ignites and then turn control knob to desired flame size. (2) Burner ports are clogged. With the burner OFF, use a small-gauge wire or needle to clean ports. See "Cleaning the Contoured Well Areas, Burner Caps, Head & Drip Pans" in the **General Care & Cleaning** section for additional cleaning instructions. (3) Range power cord is disconnected from outlet (electric ignition models only). Be sure power cord is securely plugged into the outlet. (4) Electrical power outage (electric ignition models only). Burners can be lit manually. See section on **Setting Surface Controls**.

Surface burner flame burns only part way around burner cap - (1) Burner ports are clogged. With the gas burner OFF, clean ports with a small-gauge wire or needle. (2) Moisture is present after cleaning. Lightly fan the flame & allow burner to operate until flame is full. Dry the burners thoroughly following the instructions under "Cleaning the Contoured Well Areas, Burner Caps, Head & Drip Pans" in the **General Care & Cleaning** section.

Surface burner flame is orange - (1) Dust particles in main line. Allow the burner to operate a few minutes until flame turns blue. (2) In coastal areas, a slightly orange flame is unavoidable due to salt air.

Oven does not operate - (1) Be sure the oven controls are set properly for the desired function. See **Setting Oven Controls** in this Use & Care Manual or read the instructions "**Entire appliance does not operate**" in this checklist. (2) Be sure gas regulator valve is "ON". See installation instructions.

Entire appliance does not operate - (1) The time of day is not set. The time of day **must** first be set in order to operate the oven. See "To Set the Clock" in the **Setting Oven Controls** section. (2) Make sure cord/plug is plugged correctly into outlet. (3) Service wiring is not complete. Contact your authorized service agent. (4) Electrical power outage. Check house lights to be sure. Call your local electric company for service. (5) Be sure gas supply is turned ON.

Oven light does not work (some models) - Replace or tighten bulb. See **Changing Oven Light** section in this Use & Care Manual.

Oven control beeps & displays any F code error (for example F11) - Electronic control has detected a fault condition. Press **CLEAR/OFF** to clear the display & stop beeping. Reprogram oven. If fault recurs, record fault number. Press **CLEAR/OFF** & contact an authorized service agent.

Poor baking results - Many factors affect baking results. Make sure the proper oven rack position is used. Center food in the oven & space pans to allow air to circulate. Allow the oven to preheat to the set temperature before placing food in the oven. Try adjusting the recipe's recommended temperature or baking time. If you feel the oven is too hot or cool, see **Adjusting Your Oven Temperature** in this Use & Care Manual.

Oven smokes excessively during broiling - (1) Control(s) not set properly. Follow Broil instructions under **Setting Oven Controls**. (2) Oven door is open. Make sure oven door is **closed**. (3) Meat too close to the broil burner. Reposition the broil rack to provide proper clearance between the meat & the burner. Preheat the broil burner for searing. (4) Meat not properly prepared. Remove excess fat from meat. Cut fatty edges to prevent curling, but do not cut into lean. (5) Insert on broiler pan wrong side up & grease not draining. Always place grid on the broiler pan with ribs up & slots down to allow grease to drip into pan (some models). (6) Grease has built up on oven surfaces or broiler pan & insert (some models). Regular cleaning is necessary when broiling frequently. Old grease or food spatters cause excessive smoking.

Self-Cleaning cycle does not work - (1) Oven control not set properly. Follow instructions under **Self-Cleaning**. (2) Self-Cleaning cycle was interrupted. Follow steps under "Stopping or Interrupting a Self-Cleaning Cycle" under **Self-Cleaning**.

Soil not completely removed after Self-Cleaning cycle - Failure to clean bottom, front top of oven, frame of oven or door area outside oven seal. These areas are not in the Self-Cleaning area, but get hot enough to burn on residue. Clean these areas before the Self-Cleaning cycle is started. Burned-on residue can be cleaned with a stiff nylon brush and water or a nylon scrubber. Be careful not to damage the oven gasket.

Flames inside oven or smoking from oven vent - Excessive spillovers in oven. For example this will happen for pie spillovers or large amounts of grease left on the oven bottom. Wipe up excessive spillovers before starting oven. If flames or excessive smoke are present see "Broiling" in the **Setting Oven Controls** section.



Major Appliance Warranty Information

Your appliance is covered by a one year limited warranty. For one year from your original date of purchase, Electrolux will pay all costs for repairing or replacing any parts of this appliance that prove to be defective in materials or workmanship when such appliance is installed, used and maintained in accordance with the provided instructions.

Exclusions **This warranty does not cover the following:**

1. Products with original serial numbers that have been removed, altered or cannot be readily determined.
2. Product that has been transferred from its original owner to another party or removed outside the USA or Canada.
3. Rust on the interior or exterior of the unit.
4. Products purchased "as-is" are not covered by this warranty.
5. Food loss due to any refrigerator or freezer failures.
6. Products used in a commercial setting.
7. Service calls which do not involve malfunction or defects in materials or workmanship, or for appliances not in ordinary household use or used other than in accordance with the provided instructions.
8. Service calls to correct the installation of your appliance or to instruct you how to use your appliance.
9. Expenses for making the appliance accessible for servicing, such as removal of trim, cupboards, shelves, etc., which are not a part of the appliance when it is shipped from the factory.
10. Service calls to repair or replace appliance light bulbs, air filters, water filters, other consumables, or knobs, handles, or other cosmetic parts.
11. Surcharges including, but not limited to, any after hour, weekend, or holiday service calls, tolls, ferry trip charges, or mileage expense for service calls to remote areas, including the state of Alaska.
12. Damages to the finish of appliance or home incurred during installation, including but not limited to floors, cabinets, walls, etc.
13. Damages caused by: services performed by unauthorized service companies; use of parts other than genuine Electrolux parts or parts obtained from persons other than authorized service companies; or external causes such as abuse, misuse, inadequate power supply, accidents, fires, or acts of God.

DISCLAIMER OF IMPLIED WARRANTIES; LIMITATION OF REMEDIES

CUSTOMER'S SOLE AND EXCLUSIVE REMEDY UNDER THIS LIMITED WARRANTY SHALL BE PRODUCT REPAIR OR REPLACEMENT AS PROVIDED HEREIN. CLAIMS BASED ON IMPLIED WARRANTIES, INCLUDING WARRANTIES OF MERCHANTABILITY OR FITNESS FOR A PARTICULAR PURPOSE, ARE LIMITED TO ONE YEAR OR THE SHORTEST PERIOD ALLOWED BY LAW, BUT NOT LESS THAN ONE YEAR. ELECTROLUX SHALL NOT BE LIABLE FOR CONSEQUENTIAL OR INCIDENTAL DAMAGES SUCH AS PROPERTY DAMAGE AND INCIDENTAL EXPENSES RESULTING FROM ANY BREACH OF THIS WRITTEN LIMITED WARRANTY OR ANY IMPLIED WARRANTY. SOME STATES AND PROVINCES DO NOT ALLOW THE EXCLUSION OR LIMITATION OF INCIDENTAL OR CONSEQUENTIAL DAMAGES, OR LIMITATIONS ON THE DURATION OF IMPLIED WARRANTIES, SO THESE LIMITATIONS OR EXCLUSIONS MAY NOT APPLY TO YOU. THIS WRITTEN WARRANTY GIVES YOU SPECIFIC LEGAL RIGHTS. YOU MAY ALSO HAVE OTHER RIGHTS THAT VARY FROM STATE TO STATE.

If You Need Service

Keep your receipt, delivery slip, or some other appropriate payment record to establish the warranty period should service be required. If service is performed, it is in your best interest to obtain and keep all receipts. Service under this warranty must be obtained by contacting Electrolux at the addresses or phone numbers below.

This warranty only applies in the USA and Canada. In the USA, your appliance is warranted by Electrolux Major Appliances North America, a division of Electrolux Home Products, Inc. In Canada, your appliance is warranted by Electrolux Canada Corp. Electrolux authorizes no person to change or add to any obligations under this warranty. Obligations for service and parts under this warranty must be performed by Electrolux or an authorized service company. Product features or specifications as described or illustrated are subject to change without notice.

USA
1.800.944.9044
Electrolux Major Appliances
North America
P.O. Box 212378
Augusta, GA 30907



Canada
1.800.668.4606
Electrolux Canada Corp.
5855 Terry Fox Way
Mississauga, Ontario, Canada
L5V 3E4