

Installation Instructions

for your new undercounter

KitchenAid®

COMPACTOR

BEFORE YOU USE YOUR COMPACTOR . . .

Be sure your compactor is properly installed in an appropriate level area and a place suitable for the size, function and protection of the compactor.

ELECTRICAL REQUIREMENTS

Observe All Governing Codes and Ordinances

A 120-Volt, 60 Hz, AC only, 15-Ampere fused electrical supply is required. (Time delay fuse or circuit breaker is recommended.) It is recommended that a separate circuit serving only this appliance be provided. **DO NOT** use an extension cord.

RECOMMENDED GROUNDING METHOD

DO NOT, UNDER ANY CIRCUMSTANCES, REMOVE THE POWER SUPPLY CORD GROUND PRONG.

For your personal safety, this appliance must be grounded. This appliance is equipped with a power supply cord having a 3-prong grounding plug. To minimize possible shock hazard, the cord must be plugged into a mating 3-prong grounding type wall receptacle, grounded in accordance with the National Electrical Code and local codes and ordinances. If a mating wall receptacle is not available, it is the personal responsibility and obligation of the customer to have a properly grounded 3-prong wall receptacle installed by a qualified electrician. See *Figure 1*.

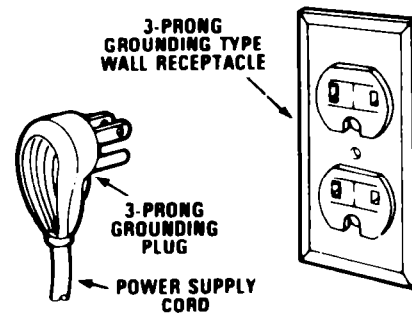

FIGURE 1

—IMPORTANT—

**DO NOT REMOVE THIS INSTRUCTION SHEET UNTIL READY FOR INSTALLATION.
AFTER COMPLETING THE INSTALLATION, SAVE THESE INSTRUCTIONS FOR FUTURE USE.**

INSTALLATION INSTRUCTIONS

BEFORE YOU BEGIN, READ THE FOLLOWING INSTRUCTIONS COMPLETELY AND CAREFULLY. THEY WILL SIMPLIFY THE INSTALLATION.

1. After removing the shipping carton, be sure to remove all protective packaging materials such as tape and shipping pads. Waxy residue from protective shipping material may be removed from compactor with a mild solution of liquid household cleaner and water.
2. Your compactor is designed for recessed installation. A six (6) inch clearance from the right edge of the drawer front is desirable for added convenience in bag removal. Also allow twenty-three (23) inches in front of the appliance for drawer removal. See Figure 2.

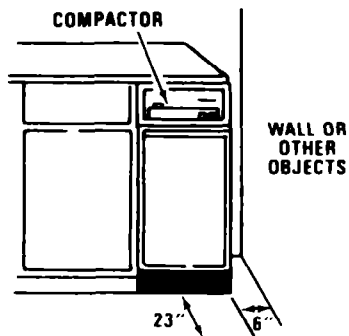

FIGURE 2

3. The compactor's overall dimensions are: Height 34-1/16" (min.), Depth 24", Width 15". Select a cabinet opening to fit. See Figure 3.

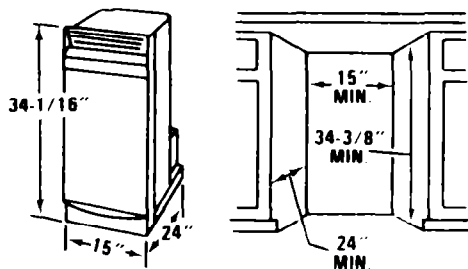

FIGURE 3

4. Remove drawer as shown:
 - a. Grip handle and raise front of drawer until it clears stops. See Figure 4.
 - b. Grasp side ridges of the drawer and lift drawer out. See Figure 5.

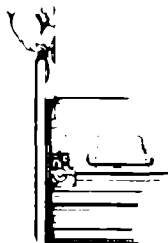

FIGURE 4

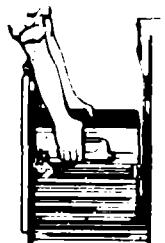

FIGURE 5

5. Remove any materials that are shipped in the drawer.
6. Lay two carton corner posts or other protective material (such as a throw rug) on the floor, then lay

the unit on either of its sides on the corner posts. The corner posts will protect the finish of the compactor and the floor. See Figure 6. NOTE: Do not truck or handle by console.

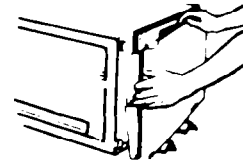

FIGURE 6

Remove the cardboard shipping pad located on the bottom. See Figure 6. Stand compactor upright.

7. A grounded receptacle should be located 18" (min.) from the floor and in the center of the opening. See Figure 7.

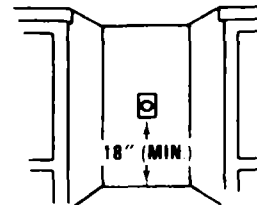

FIGURE 7

8. Before moving the compactor into position, measure the cabinet opening as shown in Figure 8. To determine if height adjustment is required, see steps 9 and 10 below.

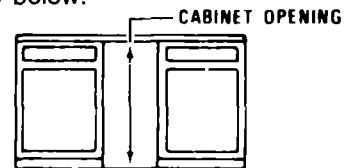

FIGURE 8

9. The rear wheels of your compactor are preset for a minimum cabinet opening of 34-1/8" to 34-1/4" (position A). To adjust for higher openings, tilt the compactor to one side and support with a corner post or a screwdriver handle.

CAUTION: Use care so that the compactor does not drop on your hand.

10. To adjust the height, remove screw from position "A" in Figure 9. Move the rear wheel and screw to position "B or C":

34-1/4" to 34-1/2" use position "B"

34-1/2" to 34-3/4" use position "C"



FIGURE 9

Repeat for other rear wheel.

- Loosen the screws in the top retaining brackets. Rotate the brackets from shipping position to the install position. Retighten. See Figure 10.

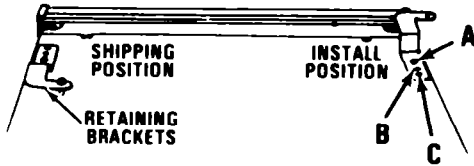

FIGURE 10

NOTE: Position "A"—Compactor frame will be flush with cabinets. Remove cabinet mount screws from retaining brackets. Save for use in step 13.

Position "B"—Midpoint between position "A" and "C."

Position "C"—Drawer front will be flush with cabinets.

- When moving or lifting the compactor, use a glove to protect and cushion your hand.

To prevent damage to floor covering, do not allow the rear frame of the compactor to touch the floor when lifting or rolling. (See Figure 11.)

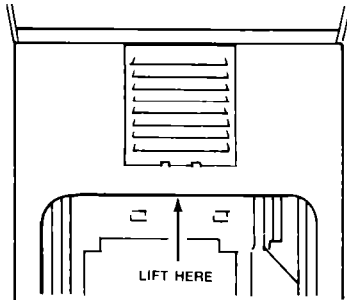

FIGURE 11

Align the rear of the compactor with the cabinet opening. Plug the power cord into a properly grounded receptacle. See Figures 1 and 7.

Lift the front of the compactor and roll into the opening until the retaining brackets stop the unit.

- Fasten the retaining brackets to the underside of the counter top with the screws provided. Use auxiliary clip for fastening to cabinet front when counter top mounting method is not permissible. See Figure 14.

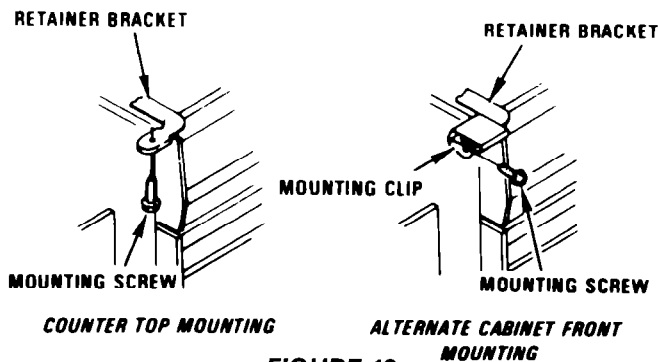

FIGURE 12

Lift the front of the compactor until it is parallel with the cabinet front. Place a screwdriver or other wedge under the front edge of the compactor.

- Loosen the screws to the front levelers (do not remove screws). Pivot the levelers to the floor and retighten screws. See Figure 13.

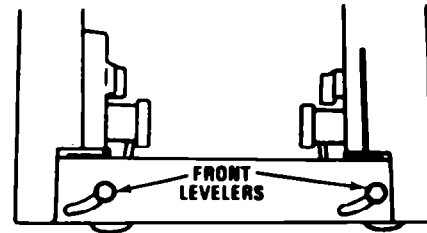

FIGURE 13

- Replace the drawer.

ADJUSTABLE TOE PLATE

In some installations, the toe plate may rub the floor covering. If this occurs, the toe plate clearance may be changed as follows:

- Determine the amount of interference of the toe plate with the floor covering.
- Remove the drawer from the unit. (Refer to Step 3 of the Installation Instructions.)
- Lay drawer so the front panel faces upward. Protect the floor.
- With a ruler and a pencil or chalk, draw a line where the toe plate interferes with the floor covering.
- Use a pair of scissors and cut toe plate along this line. See Figure 14.
- Replace drawer in unit.

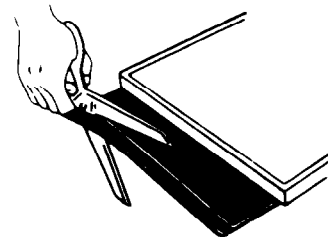
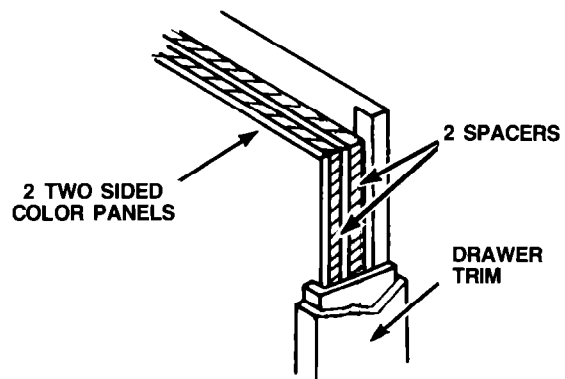

FIGURE 14

CHANGING FRONT PANEL COLOR

During installation, or in the future, you may wish to change the front panel color. Your compactor has an extra panel, which offers four color options. See detail of assembly in Figure 15.



15

CAUTION: The panels have cut metal edges. Handle carefully to avoid cuts to hands and scratches on panels.

To change the front panel color:

1. Remove the drawer from the unit. (See Step 4 of the Installation Instructions.)
2. Remove handle by removing the screws at the top inside of the drawer.
3. Remove spacer and inside panel. See Figure 15.
4. Remove spacer and center panel if supplied.
5. Remove outside front panel. DO NOT SCRATCH.
6. Select the color you wish to have showing and carefully push the panel in the drawer trim.
7. Replace the spacer, then carefully replace the remaining panels and spacers on the inside.
8. Replace the handle with the screws removed in Step 2 above.
9. Replace the drawer.

The color of the console may be changed by using one of the following console inserts from your dealer:

PART NO. 4151847 WHITE
PART NO. 4151848 ALMOND

CAUTION: REPLACE HANDLE BEFORE OPERATING COMPACTOR TO AVOID INJURY FROM MOVING PARTS.

CUSTOM DECORATING

In place of the panel pack, you may use a ¼" thick wood panel to match your cabinets or other suitable decorative material. See Figure 16.

To do so:

1. Follow Steps 1 through 5 under Changing Panel Color. Also remove all cardboard.
2. Slide decorative panel between trim pieces.
3. Remount handle with screws previously removed.
4. Slide the drawer into the unit.
5. Paint, wallpaper, fabric, etc., can be applied directly to one of the panels.

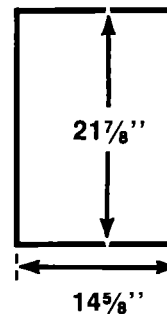

FIGURE 16