



# Use And Care

## GUIDE



ONE SPEED AUTOMATIC WASHER

6/94

MODELS LBR2132B  
LBR4132B

# A Note To You

## **Thank you for buying a Whirlpool® appliance.**

You have purchased a quality, *world-class* home appliance. Years of engineering experience have gone into its manufacturing. To ensure many years of trouble-free operation, we have developed this Use and Care Guide. It is full of valuable information on how to operate and maintain your appliance properly and safely. Please read it carefully. Also, please complete and mail the Owner-ship Registration Card provided with your appliance. This will help us notify you about any new information on your appliance.

## **Your safety is important to us.**

This guide contains safety statements under warning symbols. Please pay special attention to these symbols and follow any instructions given. Here is an example of the use of the symbol.

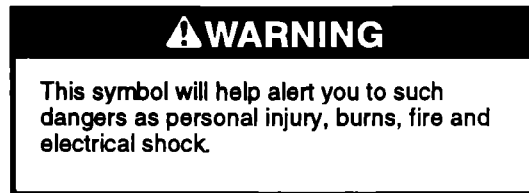

## **Our Consumer Assistance number, 1-800-253-1301, is toll-free 24 hours a day.**

If you have a question concerning your appliance's operation, or if you need service, first see "If You Need Assistance Or Service" on page 20. If you need further help, call us. When calling, you will need to know your appliance's complete model number and serial number. You can find this information on the model and serial number plate (see diagram on page 4). For your convenience, we have included a handy place below for you to record these numbers, the purchase date from the sales slip and your dealer's name and telephone number. Keep this book and the sales slip together in a safe place for future reference.

<b>Model Number</b> _____	<b>Dealer Name</b> _____
<b>Serial Number</b> _____	<b>Dealer Phone</b> _____
<b>Purchase Date</b> _____	

## IMPORTANT SAFETY INSTRUCTIONS

### **⚠ WARNING**

To reduce the risk of fire, electrical shock or injury to persons when using your washer, follow basic precautions, including the following:

- Read all instructions before using your washer.
  - Do not machine wash or machine dry items cleaned, washed, soaked in, or spotted with wax, paint, gasoline, oil, or other flammable fluids. The fumes can create a fire hazard or explosion. Always hand wash and line dry items containing these materials.
  - Flammable fluids (dry-cleaning solvents, kerosene, gasoline, etc.) should not be used or stored in or near your washer. Do not add flammable fluids to your wash water. These substances give off vapors that can create a fire hazard or explosion.
  - Do not allow children to operate, play with, or crawl on or inside your washer. Supervise children closely when your washer is used near them.
  - Before your washer is removed from service or discarded, remove the lid to prevent accidental entrapment.
  - After starting a cycle, do not reach into the basket unless the Cycle Control Knob is pushed in and all motion stops.
  - Do not tamper with the controls.
  - If your hot water has not been used recently (usually 2 weeks or longer), hydrogen gases may build up in your water heater and your hot water pipes. **HYDROGEN GAS IS EXPLOSIVE.** To prevent injury or damage, before using your washer, turn on all hot water faucets and allow water to run for several minutes. This will allow gases to escape. Do not smoke or use any open flame near your faucet while it is open.
- Please ...
- Have only a qualified person install, repair, or replace parts on washer.
  - Maintain washer properly.
  - Protect washer from the weather and keep it where the temperature will not fall below freezing.
  - Install and level washer on a floor that can support the weight.\*
  - Connect washer to the correct 3-prong outlet, electrical supply, water supply, and drain.\*
  - Ground washer properly.\*
- \*See the Installation Instructions.

### **Understanding your responsibilities**

- Store detergent, laundry aids and other materials in a cool, dry place where children cannot reach them (in a locked cabinet if possible).
- Read and follow instructions on packages of detergent and laundry aids, especially warnings and precautions.
- Do not wash or dry items that are soiled with vegetable or cooking oil. These items may contain some oil after laundering. Due to the remaining oil, the fabric may smoke or catch fire by itself.
- Do not use chlorine bleach and ammonia or acids (such as vinegar or rust remover) in the same wash. Hazardous fumes can form.
- Unplug power supply cord before attempting to service your washer.
- Do not machine wash fiberglass materials. Small particles can stick to the fabrics washed in following loads and cause skin irritation.

– SAVE THESE INSTRUCTIONS –

# Knowing Your Washer's Features

The parts and features of your washer are illustrated below. Become familiar with all parts and features before using your washer.

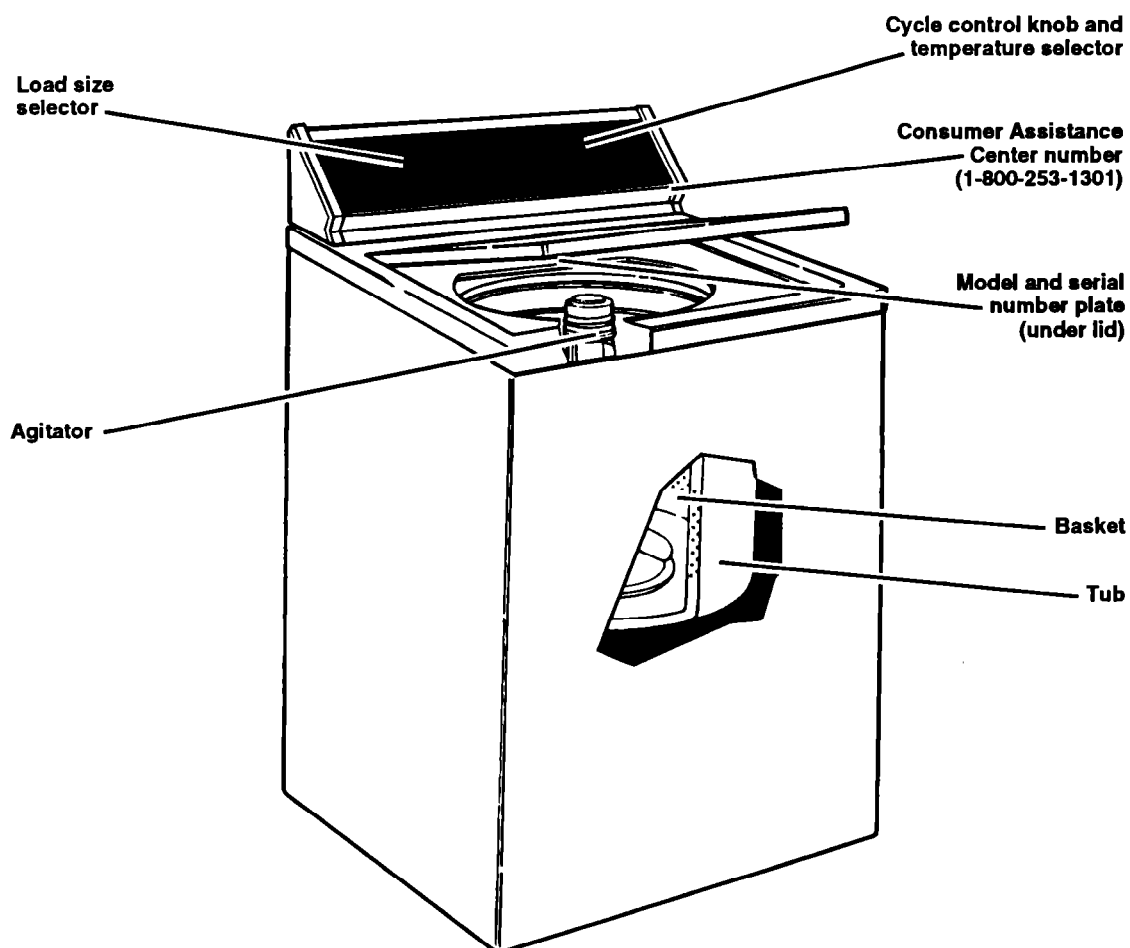

# Operating Your Washer

## In This Section

	Page		Page
Before starting your washer .....	5	Selecting a cycle and time .....	7
Starting or stopping your washer .....	5	Using rinse and spin .....	8
Selecting a load size .....	5	Using drain and spin .....	8
Selecting a wash temperature .....	6	What happens in each cycle .....	9

Operating your washer properly assures maximum washing efficiency. This section gives you important information to help you to select a cycle, time, and temperature for your wash load.

## Before starting your washer

Add measured detergent. Then place a sorted load in the washer before starting.

See page 10 for additional "Before you wash" information.

## Starting or stopping your washer

### Starting your washer:

1. Select a load size (see below).
2. Push in the Cycle Control Knob and turn it clockwise. Stop when the indicator on the knob's outer ring points to the number and wash water temperature in the cycle you want. The numbers are minutes of wash time. Wash water temperature is indicated by the letter near FILL (H=Hot, W=Warm, C=Cold). (See pages 6-8.)
3. Pull out the Cycle Control Knob.

### Stopping and restarting your washer:

- To stop the washer at any time, push in the Cycle Control Knob.
- To restart the washer, close the lid (if necessary) and pull out the Cycle Control Knob.

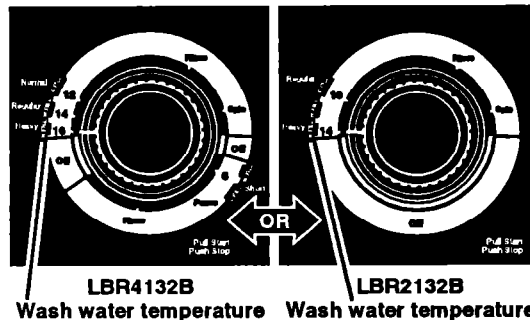

## Selecting a load size

Position the Load Size Selector at the setting that corresponds to the size load you want to wash. Select a setting based upon the size of the load and the fabric you are washing. See pages 10 and 11 for additional loading information.

To change the load size setting after the washer has started to fill, move the Selector to the desired new setting.

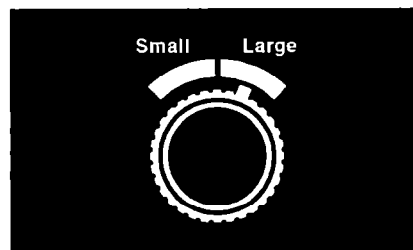

continued on next page

## OPERATING YOUR WASHER

### Load size tips

- Items should move freely during the wash. Do not overload the machine or select a load size that is too small for the wash load.
- Use the Large load size setting for best results with permanent press clothes.
- Reduce wash time when using the Small load size setting. Loads with only a few small items need less wash time.

## Selecting a wash temperature

Your washer selects a wash water temperature and time when you select a wash cycle (see "Selecting a cycle and time" on page 7).

Match wash water temperature to type of fabric and soils being washed. All rinses are cold.

### LBR4132B model:

1. For hot wash water, turn Cycle Control Knob to Heavy, 16 minutes wash.
2. For warm wash water, turn Cycle Control Knob to Regular, 14 minutes wash time.
3. For cold wash water, turn Cycle Control Knob to Normal, 12 minutes wash time.

**NOTE:** Warm and cold wash water also are available in the Short cycle.

### LBR2132B model:

1. For hot wash water, turn Cycle Control Knob to Heavy, 14 minutes wash time.
2. For warm wash water, turn Cycle Control Knob to W FILL.
3. For cold wash water, turn Cycle Control Knob to Regular, 10 minutes wash time.

You may select different wash times by first selecting the water temperature and then turning to the new wash time. For example, if you have the LBR2132B model washer and you want 10 minutes of wash time with hot water:

1. Push in Cycle Control Knob and turn it clockwise to 14 (hot wash water).
2. Pull out Cycle Control Knob and allow your washer to fill.
3. When your washer has filled, push in and turn Cycle Control Knob clockwise to 10. (Your washer may add a small amount of additional cold water, but this should not affect the overall desired wash water temperature.)
4. Pull out Cycle Control Knob.

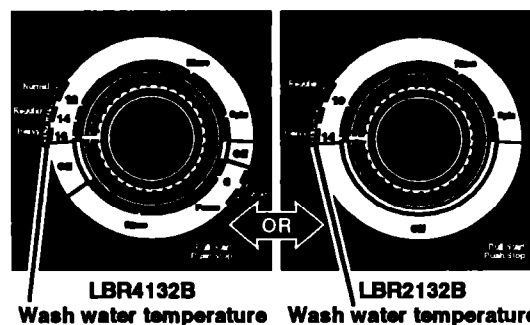

**NOTE:** Follow the same procedure if you have the LBR4132B model washer.

### Water temperature tips:

- Use warm or hot wash water with permanent press fabrics.
- For heavily-soiled permanent press or knit clothes, pre-wash or pre-soak in warm water before washing.

See the "Water usage guide" on page 14 for more information.

## Selecting a cycle and time

Use the following information to guide you when selecting a wash cycle and time.

When you select a wash cycle, your washer selects the wash water temperature. If you want a different temperature, see "Selecting a wash temperature" on page 6.

### **LBR4132B**

This model has the following cycles.

#### **Heavy cycle**

The Heavy cycle features hot water for heavy soils and longer spins to shorten drying time.

- Use 16 minutes of wash time to clean sturdily constructed fabrics and heavily soiled loads.

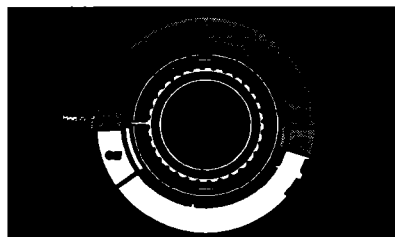

#### **Regular cycle**

The Regular cycle features warm wash water and longer spins to shorten drying time. This cycle is suitable for most loads.

- Use 14 minutes of wash time to clean cottons, permanent press and some synthetic fabrics that are moderately to heavily soiled.

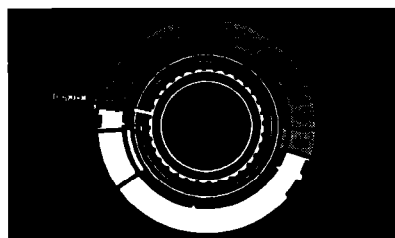

#### **Normal cycle**

The Normal cycle features cold wash water for special fabrics and longer spins to shorten drying time.

- Use 12 minutes of wash time to clean cotton and linen fabrics that are lightly to moderately soiled.

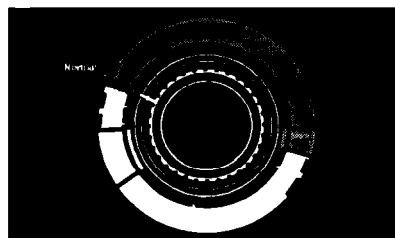

#### **Short cycle**

The Short cycle features a brief wash cycle with warm or cold wash water for gentle soil removal.

- Use 6 minutes of wash time to clean delicate items and washable knits that are lightly soiled.

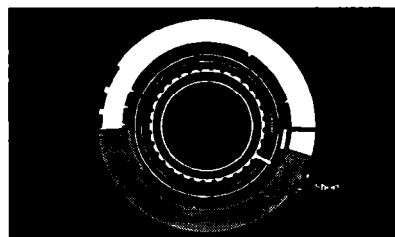

**NOTE:** During the Short cycle, the machine will pause for a brief soak period (2 minutes). The word PAUSE on the Cycle Control Knob indicates a period of no agitation.

# OPERATING YOUR WASHER

## LBR2132B

This model has the following cycles.

### Heavy cycle

The Heavy cycle features hot water for heavy soils and longer spins to shorten drying time.

- Use 14 minutes of wash time to clean sturdily constructed fabrics and heavily soiled loads.

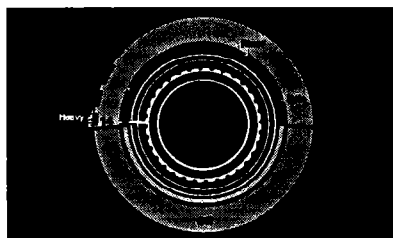

### Regular cycle

The Regular cycle features cold wash water for special fabrics, and longer spins to shorten drying time.

- Use 10 minutes of wash time to clean delicates, washable knits, cottons, permanent press and some synthetic fabrics that are lightly to moderately soiled.

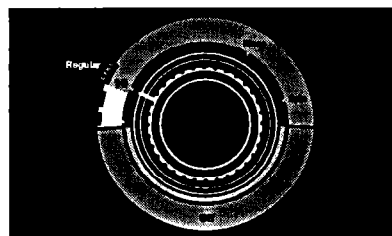

## Using rinse and spin

When using extra detergent for heavily soiled clothes, or washing special-care items, you may want an extra rinse and spin.

1. Push Cycle Control Knob in and turn clockwise until indicator points to RINSE, as illustrated.
2. Pull Cycle Control Knob out. The washer fills to selected load size, agitates, drains, and spins.

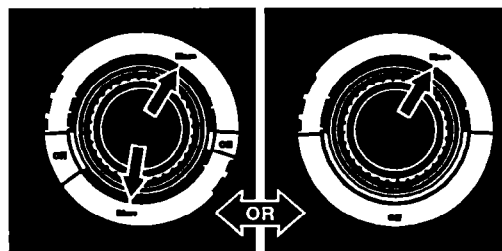

LBR4132B

LBR2132B

## Using drain and spin

A drain and spin may help shorten drying times for some heavy fabrics or special-care items by removing excess water.

1. Push Cycle Control Knob in and turn clockwise until indicator points to SPIN, as illustrated.
2. Pull Cycle Control Knob out. The washer drains and spins.

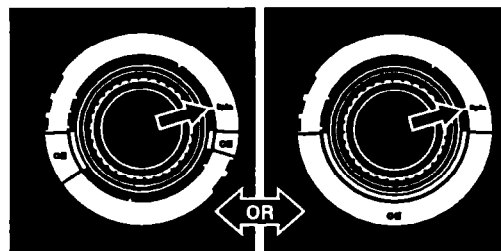

LBR4132B

LBR2132B



## What happens in each cycle

When the Cycle Control Knob is set to a number and pulled out, the washer fills to the selected water level with the selected water temperature before agitation and timing start. The washer will begin agitating immediately after filling; agitation can occur with the washer lid up or down. After agitation starts, the knob turns clockwise until it points to OFF and the cycle ends.

**The washer pauses briefly throughout each cycle.** These pauses are normal for washer operation.\*

**NOTE:** If your washer drains into a laundry tub, remove lint collected in the tub or strainer.

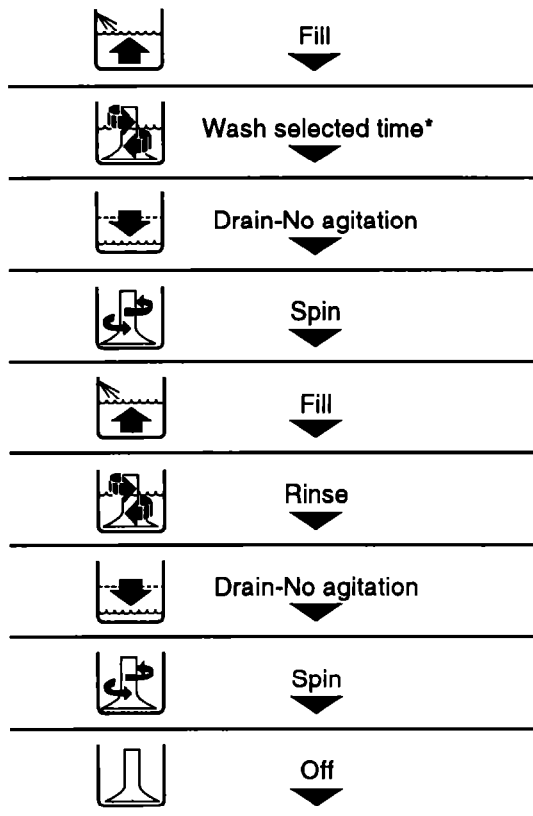

\*Model LBR4132B has a 2-minute pause during the Short cycle (see page 7).

# Laundry Tips

<b>In This Section</b>		<b>Page</b>	<b>Page</b>	
<b>Before you wash</b> .....		<b>10</b>	<b>Solving laundering problems</b> .....	<b>18</b>
<b>Removing stains</b> .....	<b>11</b>		<b>Caring for your washer</b> .....	<b>19</b>
<b>Water usage guide</b> .....	<b>14</b>		<b>Care during periods of non-use</b> .....	<b>19</b>
<b>Using laundry aids</b> .....	<b>15</b>		<b>Saving energy</b> .....	<b>19</b>
<b>Washing special-care items</b> .....	<b>16</b>			

This section reviews proper laundering techniques, gives you additional washing information, and discusses solutions to common laundering problems.

## Before you wash

### Preparing clothes for washing

- Close zippers, snaps, and hooks to avoid snagging other items. Remove pins, buckles, and other hard objects to avoid scratching the washer interior. Remove unwashable trim and ornaments.
- Empty pockets and turn them inside out.
- Turn down cuffs and brush away lint and dirt.
- Turn synthetic knits inside out to avoid pilling.
- Tie strings and sashes so they will not tangle.
- Mend tears, loose hems and seams.
- Treat spots and stains. (See pages 11-13 for pretreatment and stain removal information.)
- Stained or wet garments should be washed promptly for best results.



### Sorting

- Separate heavily soiled items from lightly soiled ones even if they would normally be washed together. Separate lint givers (towels, chenille) from lint takers (corduroy, synthetics, permanent press). When possible, turn lint givers inside out.
- Separate dark from light colors, colorfast from noncolorfast.
- Sort by fabric and construction (sturdy cottons, knits, delicate items).



### Loading

- Drop items into washer loosely. Fill to the top of the basket, but do not pack or wrap items around the agitator. Items should move easily through wash water for best cleaning and wrinkle-free results. Watch for rollover. Items should sink and reappear later.
- Load washer properly. Overloading or packing can:
  - cause poor cleaning.
  - increase wrinkling.
  - create excessive lint.
  - wear out items faster (because of pilling).
- Load by the amount of space items take up, not by their weight.
- Mix large and small items in each load. Load evenly to maintain washer balance. An off-balance load can make the machine vibrate during spin. To reduce wrinkling, permanent press and synthetic knits should have more room to move in the water than heavy items (towels, jeans).



**Loading suggestions**

For these suggested full-sized loads, use the Large load size setting.

<b>LARGE CAPACITY WASHERS</b>			
<b>Heavy Work Clothes</b> 2 pair pants 3 shirts 3 pair jeans 1 coverall	<b>Permanent Press</b> 1 double sheet 1 tablecloth 1 dress 1 blouse 2 slacks 3 shirts 2 pillowcases	<b>Mixed Load</b> 2 double or 1 king size sheet(s) 4 pillowcases 6 T-shirts 2 pair shorts 2 shirts 2 blouses 6 handkerchiefs	<b>Towels</b> 8 bath towels 8 hand towels 10 wash cloths 1 bathmat
<b>Knits</b> 2 slacks 2 blouses 4 shirts 4 tops 2 dresses			<b>Delicates</b> 2 camisoles 4 slips 4 panties 2 bras 2 nighties

**Removing stains**

Stained, heavily soiled or greasy items may need to be prewashed or soaked for best results. Soaking helps remove protein-type stains like blood, milk, or grass. Prewashing helps loosen soil before washing.

**Prewashing or soaking**

Use warm water for soaking or prewashing stained laundry. Hot water can set stains.

**Stain removal rules**

- Most stains are easier to remove when they are fresh. Old or set stains may not come out. Follow package directions for pretreatment products.
- Before treating any stain, find out ...
  1. What kind of stain it is.
  2. What kind of fabric it is and if it is colorfast (check label).

3. How old the stain is. Washing and drying can set some stains.
- Start with cold or warm water. Hot water can set some stains.
  - When bleach is recommended, use a bleach that is safe for the fabric. Dilute chlorine bleach.
  - Test stain removers on an inside seam or hidden corner of the item to see if the color is removed.
  - Put the stained area face down on a paper towel or white cloth. Apply the stain remover to the back of the stain. This can force the stain off the fabric instead of through it.
  - Meat tenderizer or enzyme presoaks help break down some protein stains so they are easier to remove.

## LAUNDRY TIPS

### Stain removal guide

STAIN	TO REMOVE
<b>Alcoholic beverage</b>	These stains turn brown with age, so treat immediately. Sponge or soak fresh stains with cold water. Wash. If stain remains, soak 15 minutes in a solution of lukewarm water, liquid detergent and a few drops of white vinegar. Rinse. Wash.
<b>Blood</b>	Rinse immediately or soak in cold water with enzyme presoak for 30 minutes or longer. Rinse. Rub detergent into any remaining stains. Rinse. If stain remains, put a few drops of 3% hydrogen peroxide on stain for 3-5 minutes. Rinse thoroughly. Wash.
<b>Chewing gum</b>	Use ice to make gum hard. Scrape off what you can. Sponge with a nonflammable fabric cleaner. Let dry. Wash.
<b>Chocolate or coffee</b>	Sponge immediately with a nonflammable fabric cleaner or apply a prewash soil and stain remover. Rinse. Wash. If stain remains, apply a liquid detergent to stain or soak in warm water with an enzyme presoak. Rewash.
<b>Crayon and candle wax</b>	Scrape off excess with a dull knife. Place fabric between two blotters or facial tissue. Press with warm iron. Remove color stain with nonflammable fabric cleaner. Hand wash until stain is gone. If full load is crayon stained, take to cleaners or coin-operated dry cleaning machine.
<b>Cream, milk or ice cream</b>	Sponge with a nonflammable fabric cleaner, or a prewash soil and stain remover. Rinse. Wash. Repeat if necessary. If stain remains, apply a few drops of liquid detergent and a few drops of ammonia. Blot dry and rinse. If stain remains, soak in an enzyme presoak. Wash.
<b>Deodorants and anti-perspirants</b>	<b>Light stain:</b> Treat with liquid detergent or your regular laundry detergent. Wash in hottest water safe for fabric. <b>Heavy stain:</b> Place face down on towel and treat with a paste of ammonia and all-fabric bleach. Let stand for 30 minutes. Wash in hottest water safe for fabric.
<b>Fat, grease or oil</b>	Items soiled with vegetable or cooking oil should not be washed or dried. See vegetable/cooking oil Warning on page 3. For other types of greasy stains, use one of the methods below: <ul style="list-style-type: none"> <li>• Use pretreatment stain remover. Follow label directions. Wash in hottest water safe for fabric.</li> <li>• Use talcum powder to absorb as much grease as possible. Sponge with a nonflammable fabric cleaner. Rinse. Wash.</li> <li>• Treat with liquid detergent or rub a detergent paste on the stain. Wash using hottest water safe for fabric.</li> </ul>
<b>Fruit stains</b>	<b>Fresh stains:</b> Soak immediately in cool water. Wash. If stain remains, cover area with a paste made of all-fabric bleach, a few drops of hot water and a few drops of ammonia. Wait 15 to 30 minutes. Wash. <b>Old stains:</b> Sponge with white vinegar. Rinse, then follow procedure for fresh stains.
<b>Grass or green vegetables</b>	Soak in warm or cold water with an enzyme presoak for at least 30 minutes, or sponge with denatured alcohol. Wash in water temperature and bleach safe for the fabric. For colored fabrics, check colorfastness before applying alcohol. For acetate, sponge with a nonflammable fabric cleaner. If stain remains, bleach with 3% hydrogen peroxide. Rinse. Rewash.
<b>Ink or ballpoint pen ink</b>	Spray stain with an aerosol hair spray or rubbing alcohol. Sponge stain continuously until all bleeding stops. Let dry. Repeat if necessary. Wash. If stain remains, bleach if safe for fabric. (India and other indelible inks are almost impossible to remove completely.)

## LAUNDRY TIPS

STAIN	TO REMOVE
<b>Iron or rust</b>	<p><b>Colored or noncolorfast items:</b> Apply lemon juice and salt. Place in the sun to dry. Rinse thoroughly. Repeat if necessary.</p> <p><b>White or colorfast items:</b> Try a rust remover. Test first on inside seam or hem. Some rust removers are not washer safe. Follow package directions.</p>
<b>Ketchup or tomato products</b>	Sponge immediately with a nonflammable fabric cleaner or apply a prewash soil and stain remover. Rinse. Wash. If stain remains, apply a liquid detergent to stain or soak in warm water with an enzyme presoak. Rewash.
<b>Lipstick</b>	Apply nonflammable fabric cleaner or prewash soil and stain remover. Blot with absorbent material. Repeat if necessary. Rinse. If stain still remains, rub with liquid detergent. Wash.
<b>Meat juice, egg</b>	Scrape off excess with a dull knife. Soak in cold or warm water with enzyme presoak at least 30 minutes, or treat stains with a nonflammable fabric cleaner. Wash.
<b>Mildew</b>	Wash in hottest water safe for fabric. If stain remains, soak in warm water and an all-fabric bleach for 15 to 30 minutes. Rewash. (Old mildew stains are almost impossible to remove. Mildew fungus destroys or weakens fabrics.) An alternative to bleach is to treat with salt and lemon juice and dry in direct sunlight. Rinse and rewash. Mildew may form if wet or damp laundry remains in your washer for extended periods of time. To prevent mildew, promptly dry laundry after washing.
<b>Mustard</b>	Treat immediately. Scrape off excess mustard. Sponge with a nonflammable fabric cleaner or a prewash soil and stain remover. Rinse. Work liquid detergent and a few drops of vinegar into stain. Rinse. If stain remains, apply 3% hydrogen peroxide. Rinse and wash.
<b>Paint</b>	<p>Hand wash paint-stained items.</p> <p><b>Water base:</b> Treat stains while still wet. (These paints cannot be removed after they have dried.) Rinse in warm water to flush out paint. Sponge with a nonflammable fabric cleaner. Rinse. Wash.</p> <p><b>Oil base:</b> Scrape off fresh paint. Sponge with a nonflammable fabric cleaner or treat stain with recommended thinner. While stain is still wet with solvent, rub liquid detergent into it. Wash with hottest water safe for fabric.</p>
<b>Perspiration</b>	<p>Remove stains before ironing. Perspiration stains may weaken fabric. Wash or sponge stain thoroughly with detergent and warm water. If perspiration has changed the color of the fabric, use one of the following treatments:</p> <p><b>Fresh stains:</b> Apply ammonia to stain. Rinse. Launder to remove ammonia odor.</p> <p><b>Old stains:</b> Apply white vinegar to stain. Rinse. Launder to remove vinegar odor.</p>
<b>Scorch</b>	<p>Severe scorch cannot be removed. Wet stain with 3% hydrogen peroxide. Cover with a dry cloth and press with an iron as hot as is safe for fabric. Rinse well. Wash.</p> <p><b>OR</b></p> <p>Wet with lemon juice and spread in the sun to dry. Wash.</p>
<b>Soft drinks</b>	Sponge immediately with cold water and alcohol. Heat and detergent may set stain.

## Water usage guide

### Water temperature

WASH	RINSE	USE FOR	COMMENTS
<b>HOT</b> 130°F (54°C) or above	<b>COLD</b>	<ul style="list-style-type: none"> <li>• Heavy soils</li> <li>• Work clothes</li> <li>• Sturdy whites and colorfast pastels</li> <li>• Diapers</li> </ul>	<ul style="list-style-type: none"> <li>• Gives best cleaning for heavy soils.</li> <li>• Removes oils, perspiration, greasy soils and stains.</li> <li>• Prevents graying and yellowing.</li> </ul>
<b>WARM</b> 90°-110°F (32°-44°C)	<b>COLD</b>	<ul style="list-style-type: none"> <li>• Light and moderate soils</li> <li>• Dark or noncolorfast colors</li> <li>• Moderately soiled permanent press</li> <li>• Nylons, polyesters, acrylics, silks, woolens</li> <li>• Knits and delicate fabrics</li> <li>• Prewash, soak</li> </ul>	<ul style="list-style-type: none"> <li>• Safe for most fabric finishes.</li> <li>• Less fading and dye bleeding.</li> <li>• Reduces wrinkling.</li> </ul>
<b>COLD</b> 70°-90°F (21°-32°C)	<b>COLD</b>	<ul style="list-style-type: none"> <li>• Very lightly soiled items</li> <li>• Moderately soiled items if extra detergent is added</li> <li>• Extra sensitive colors (noncolorfast)</li> <li>• Rinsing, for all fabrics</li> </ul>	<ul style="list-style-type: none"> <li>• Saves hot water.</li> <li>• Less effective cleaning than hot or warm water.</li> <li>• Use longest wash time in cycle selected.</li> <li>• Use liquid detergent, or dissolve powdered detergent in warm water before adding to cold wash water.</li> <li>• Pretreat spots, stains and heavy or greasy soils.</li> </ul>

#### To check your hot water temperature with a candy or cooking thermometer:

1. Fill a pan with the hottest water available from the faucet that will fill your washer.
2. Place a candy or cooking thermometer in water to check the temperature.

If you do not have a faucet at your wash site, collect water from the faucet closest to your washer.

**NOTE:** In wash-water temperatures colder than 70°F (21°C):

- Detergents do not dissolve well.
- Soils are difficult to remove.
- Some fabrics will retain wear wrinkles and may have increased pilling.

#### Water hardness

Many poor washing results can be traced to wash-water hardness. To check your water hardness:

- City water—ask your city water company.
- Well water—call your local water authority.

Ask for the mineral content in grains-per-gallon or parts-per-million. If your water is 9 or more grains-per-gallon or more than 153 parts-per-million:

- Consider installing a water softener.
- Use more detergent.
- Use a packaged water conditioner.
- Do not use soap.

## Using laundry aids

Follow package instructions when using laundry aids. (See "Removing Stains" on pages 11-13 for more information.)

### **! WARNING**

#### **Fire or Explosion Hazard**

- Store flammable solvents or liquids away from your washer.
- Dry-cleaning solvents or fluids should not be put directly into your washer.
- Items treated with solvents should be rinsed and air dried before washing in your washer.

The fumes from these substances can create a fire hazard or explosion.

#### **Personal Injury Hazard**

- Never use chlorine bleach with ammonia or acids. Hazardous fumes can form.
- Keep stain removal products out of the reach of children ... preferably in a locked cabinet.

### All-fabric bleach

- Powdered or liquid all-fabric bleach may be used on all types of fabrics.
- Do not use all-fabric bleach in the bleach dispenser because it may clog.

### Chlorine bleach

- To add bleach:
  1. Let the washer fill and begin agitating the load.
  2. Dilute measured bleach in 1 quart (1L) of water.
  3. Pour bleach around agitator, not directly on load.
- Follow directions on care labels. Do not use chlorine bleach on wool, silk, spandex, acetates or some flame-retardant fabrics.
- Measure bleach. Do not guess. Never use more than 1 cup (250mL) for a full load. Add bleach to wash cycle so it can be removed in the rinse cycle.
- When soaking with chlorine bleach, add detergent to soak water.

**NOTE:** Undiluted bleach will damage any fabric it touches. The damage appears as rips, holes, tears or color loss and may not show up until several washings later.

### Detergent

- Using too little detergent is a common cause of laundry problems. Follow manufacturer's directions. Measure accurately, especially when using ultra detergents. Package directions are usually based on:
  - moderate water hardness (4-6 grains)
  - lightly soiled items
  - normal wash loads.
- Use more detergent for:
  - hard water
  - cooler wash water
  - full loads
  - heavily soiled items.
- Do not judge the amount of detergent to use by the amount of suds in the machine. Low sudsing detergents do not create as many suds as normal sudsing detergents.
- If the recommended amount of normal sudsing detergent creates too many suds or suds are present in the rinse water, try a low sudsing detergent.

### Fabric softeners

- Add diluted fabric softener only in the final rinse.
- Always dilute fabric softeners with 1/2 to 1 cup (125 to 250 mL) warm water. Undiluted fabric softener can stain fabrics.
- Fabric softeners should not be mixed with other laundry products because greasy stains may form. If stains form, remove by wetting the stain and rubbing with liquid detergent or a bar of soap. Rewash the stained item.
- Too much fabric softener can make some items (diapers and towels) non-absorbent. If this happens, use less fabric softener or do not use it every time.

## Washing special-care items

Most garments and household textiles have care labels with laundering instructions. **Always follow care label directions when they are available.** General washing instructions for some special washables are included in this section.

<p><b>Blankets</b></p>	<p>Pretreat spots and stains. Select water temperature, cycle, and time according to the type of blanket being washed. Two rinses may be necessary.</p> <p>If manufacturer recommends machine washing:</p> <ol style="list-style-type: none"> <li>1. Measure blanket before washing.</li> <li>2. Add mild detergent to washer. Fill and agitate briefly to dissolve detergent.</li> <li>3. Stop washer. Load blanket evenly around agitator. Soak 10 to 15 minutes.</li> <li>4. Set Cycle Control Knob to Drain and Spin. Start washer. Spin 1 to 2 minutes.</li> <li>5. Fill washer for final rinse. Stop washer. Allow to soak.</li> <li>6. Set Cycle Control Knob to Drain and Spin. Start washer. Allow washer to finish cycle.</li> <li>7. Lay blanket on flat surface and block by gently stretching to original measurement. Woolens tend to shrink more the first time they are washed. This is normal.</li> </ol>
<p><b>Curtains, drapes, slipcovers</b></p>	<p>Wash small loads. Crowding will cause wrinkling.</p> <ol style="list-style-type: none"> <li>1. Shake or vacuum to remove loose dirt.</li> <li>2. Wash following manufacturer's instructions.</li> </ol> <p><b>NOTE:</b></p> <ul style="list-style-type: none"> <li>• Sun-damaged curtains and draperies will tear whether hand or machine washed.</li> <li>• Replace slipcovers while still slightly damp. They will dry to fit tightly.</li> </ul>
<p><b>Diapers</b></p>	<p>When using chlorine bleach for soaking, add detergent to load. Avoid overuse of fabric softeners. Absorbency will be reduced.</p> <ol style="list-style-type: none"> <li>1. Rinse immediately. Soak in a solution of lukewarm water and a small amount of detergent until you are ready to wash them. You may wish to use bleach or a special soaking product when soaking.</li> <li>2. Spin excess water from diapers before washing.</li> <li>3. Wash diapers as you would wash white cottons and linens.</li> </ol>
<p><b>Elastic, spandex</b></p>	<p>Elastic picks up oil from the body. Oil can damage elastic. Wash often to help reduce the damage. Use warm water and sufficient detergent to remove oils.</p>
<p><b>Flame-retardant clothing</b></p>	<p>Items will be clearly labeled as flame-retardant. Follow manufacturer's instructions to retain flame retardant qualities.</p>



<p><b>Knits</b></p>	<p>Knits are comfortable to wear because they stretch. However, this means that knits are more likely to be stretched and damaged when washed (especially bulky knits). Knits made of synthetic fabrics such as polyester, nylon, and acrylic tend to keep their original shape more than a knit made of cotton or ramie.</p> <ol style="list-style-type: none"> <li>1. Close zippers, fasten hooks and eyes to prevent snagging.</li> <li>2. Wash small loads to reduce pilling and lint.</li> </ol>
<p><b>Pillows, stuffed toys</b></p>	<p>Washing feather pillows is not recommended unless they are dryer dried.</p> <ol style="list-style-type: none"> <li>1. Add detergent, then partially fill washer with water; agitate until detergent is dissolved.</li> <li>2. Place two pillows on opposite sides of the agitator to balance the load.</li> <li>3. Allow washer to fill completely and continue through the cycle.</li> <li>4. Stop the washer occasionally to press air from item(s) being washed.</li> </ol>
<p><b>Plastic, rubber items</b></p>	<p>Treat as delicate items. Wash in warm water. Wash small items in a mesh bag.</p>
<p><b>Quilts, bedspreads</b></p>	<p>Do not wash cotton-filled comforters unless they are quilted or stitched; tucked cotton batting tends to slip and become lumpy.</p>
<p><b>Scatter rugs</b></p>	<ol style="list-style-type: none"> <li>1. Shake or vacuum to remove loose dirt.</li> <li>2. Wash more than one small rug at a time. If you wash only one rug, add bath towels to balance the load. A larger rug should be distributed around the agitator to balance the load.</li> </ol>
<p><b>Snowsuits, jackets, etc.</b></p>	<ol style="list-style-type: none"> <li>1. Wash only one or two items at a time. Load evenly around the agitator.</li> <li>2. Stop the washer occasionally to press air from item(s) being washed.</li> <li>3. Two rinses may be necessary.</li> </ol>

## Solving laundering problems

Most laundering problems are easily solved if you understand the cause. Check the following list for problems you may have and possible causes. If you need additional help, check the "If You Need Assistance Or Service" section of this book.

<b>PROBLEM</b>	<b>CAUSE</b>
<b>Brown, yellow stains</b>	<ul style="list-style-type: none"> <li>• Chlorine staining</li> <li>• Iron in water heater or pipes</li> <li>• Iron and manganese in water</li> </ul>
<b>Dye transfer</b>	<ul style="list-style-type: none"> <li>• Improper sorting</li> <li>• Load not immediately removed from washer after end of cycle</li> </ul>
<b>Gray whites, dingy colors</b>	<ul style="list-style-type: none"> <li>• Improper sorting</li> <li>• Water temperature too low</li> <li>• Not enough detergent</li> <li>• Using soap in very hard water (use detergent if you have hard water)</li> </ul>
<b>Greasy looking spots</b>	<ul style="list-style-type: none"> <li>• Undiluted fabric softener or fabric softener poured directly on load</li> <li>• Fabric softener in wash water</li> <li>• Not enough detergent</li> </ul>
<b>Lint</b>	<ul style="list-style-type: none"> <li>• Improper sorting</li> <li>• Paper or tissue in pockets</li> <li>• Pilling being mistaken for lint</li> <li>• Overloading</li> <li>• Not enough detergent</li> </ul>
<b>Load too wet after spin</b>	<ul style="list-style-type: none"> <li>• Cold rinses</li> <li>• Lid is opened before spinning is completed</li> </ul>
<b>Shrinking</b>	<ul style="list-style-type: none"> <li>• Fabric type (some knits stretch during manufacturing—laundering returns fabric to original size)</li> <li>• Care label directions not followed</li> </ul>
<b>Snags, rips, holes</b>	<ul style="list-style-type: none"> <li>• Items damaged before washing</li> <li>• Misuse of chlorine bleach</li> <li>• Sharp articles not removed from pockets</li> <li>• Overloading</li> <li>• Fasteners not fastened</li> </ul>
<b>Stiff, rough fabrics (usually cottons)</b>	<ul style="list-style-type: none"> <li>• Using soap in very hard water (use detergent if you have hard water)</li> <li>• Not enough detergent</li> <li>• Line drying</li> </ul>
<b>Twisting, tangling</b>	<ul style="list-style-type: none"> <li>• Overloading</li> <li>• Improper loading (do not wrap large items around agitator)</li> </ul>
<b>Wrinkling</b>	<ul style="list-style-type: none"> <li>• Overloading</li> <li>• Load not immediately removed from washer after end of cycle</li> <li>• Warm rinse water</li> <li>• Cycle selection is incorrect (based on fabric type)</li> </ul>
<b>Yellow areas (from body oils)</b>	<ul style="list-style-type: none"> <li>• Water temperature too low</li> <li>• Not enough detergent</li> </ul>

## Caring for your washer

- Wipe up detergent, bleach, and other spills with a soft, damp cloth or sponge as they occur.
- Remove hard water deposits using only cleaners labeled as washer safe.
- If the washer interior needs cleaning (for example, after tinting or dyeing), put 1 cup (250 mL) of chlorine bleach and 2 cups (500 mL) of detergent in the washer. Run through a complete cycle using hot water. If staining occurs on following loads, repeat the process.
- Sharp or metal objects can damage your washer. Check pockets for pins, clips, money, bolts, nuts, etc. Do not lay these objects on your washer after emptying pockets.

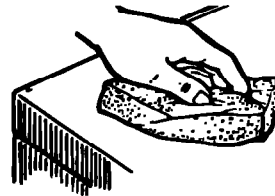

**NOTE:** Operate your washer only when you are at home.

## Care during periods of non-use

### Winter storage or moving care

Install and store your washer where it will not freeze. Because some water stays in the washer, freezing can damage it. If your washer is stored or moved during freezing weather, winterize it.

1. Shut off both water faucets. Disconnect the drain water inlet hoses.
2. Put 1 quart (1 L) of R.V.-type antifreeze in the basket.
3. Run washer on a drain and spin setting (see page 8) for about 30 seconds to mix the antifreeze and water.
4. Unplug power supply cord.

### To use the washer again:

1. Flush water pipes and hoses.
2. Reconnect water inlet hoses.
3. Turn on both water faucets.
4. Reconnect power supply cord.
5. Run the washer through a complete cycle with 1 cup (250 mL) of detergent to clean out antifreeze.

### Non-use/vacation care

1. Unplug power supply cord or turn off electrical power.
2. Turn off water supply leading to your washer. This will help avoid accidental flooding while you are away (for example, due to a water pressure surge).

## Saving energy

- Use warm or cold wash water for most loads. Use hot water only when washing heavy, greasy soils or whites.
- Use cold rinses.
- Wash full loads.
- Use lower water levels when washing small loads.
- Use your washer during off-peak hours. (Ask your power company for details.)

# If You Need Assistance Or Service

## 1. Before calling for assistance ...



Is your water turned on?

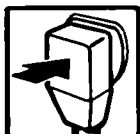

Is the power cord plugged in?



Have you blown a fuse or tripped the circuit breaker?

If you need more help, check the chart below.

<b>PROBLEM</b>	<b>CHECK THE FOLLOWING</b>
<b>Washer will not fill</b>	Are both hot and cold water faucets open? Are the water supply hoses kinked? Is the Cycle Control Knob set and pulled out?
<b>Washer does not spin</b>	Is the lid closed?
<b>Washer stops during a cycle</b>	Washer pauses briefly at different times in each cycle. These pauses are normal. The LBR4132B model has a 2-minute pause during the Short cycle (see page 7).
<b>Washer fills and drains without running</b>	Is the Cycle Control Knob pointing to a number in the cycle?
<b>Washer drains during wash and rinse cycles, or water siphons out</b>	Adjust the drain hose so that it is higher than the water level in the washer.

**2. If you need assistance\* ...**

Call Whirlpool Consumer Assistance Center telephone number. Dial toll-free from anywhere in the U.S.A.:

**1-800-253-1301**

and talk with one of our trained consultants. The consultant can instruct you in how to obtain satisfactory operation from your appliance or, if service is necessary, recommend a qualified service company in your area.

If you prefer, write to:

Mr. William Clark  
Consumer Assistance Representative  
Whirlpool Corporation  
2000 N State Route 63  
Benton Harbor, MI 49022-2692

Please include a daytime phone number in your correspondence.

**3. If you need service\* ...**

Whirlpool has a nationwide network of authorized Whirlpool® service companies. Whirlpool service technicians are trained to fulfill the product warranty and provide after-warranty service, anywhere in the United States. To locate the authorized Whirlpool service company in your area, call our Consumer Assistance Center telephone number (see Step 2) or look in your telephone directory Yellow Pages under:

• APPLIANCE-HOUSEHOLD-  
MAJOR, SERVICE & REPAIR

- See: Whirlpool Appliances or  
Authorized Whirlpool Service  
(Example: XYZ Service Co.)

• WASHING MACHINES &  
DRYERS, SERVICE & REPAIR

- See: Whirlpool Appliances or  
Authorized Whirlpool Service  
(Example: XYZ Service Co.)

**\* When asking for help or service:**

Please provide a detailed description of the problem, your appliance's complete model and serial numbers and the purchase date. (See page 2.) This information will help us respond properly to your request.

**4. If you need FSP® replacement parts ...**

FSP is a registered trademark of Whirlpool Corporation for quality parts. Look for this symbol of quality whenever you need a replacement part for your Whirlpool® appliance. FSP replacement parts will fit right and work right, because they are made to the same exacting specifications used to build every new Whirlpool appliance.

To locate FSP replacement parts in your area, refer to Step 3 above or call the Whirlpool Consumer Assistance Center number in Step 2.

**5. If you are not satisfied with how the problem was solved ...**

- Contact the Major Appliance Consumer Action Panel (MACAP). MACAP is a group of independent consumer experts that voices consumer views at the highest levels of the major appliance industry.
- Contact MACAP only when the dealer, authorized servicer and Whirlpool have failed to resolve your problem.

Major Appliance Consumer Action Panel  
20 North Wacker Drive  
Chicago, IL 60606

- MACAP will in turn inform us of your action.

**Gearcase  
assembly covered  
by your warranty**

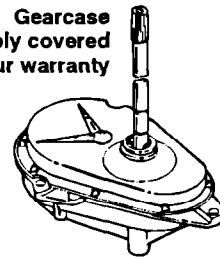

# WHIRLPOOL®

## Automatic Washer Warranty

LENGTH OF WARRANTY	WHIRLPOOL WILL PAY FOR
<b>FULL ONE-YEAR WARRANTY</b> From Date of Purchase	FSP® replacement parts and repair labor to correct defects in materials or workmanship. Service must be provided by an authorized Whirlpool service company.
<b>LIMITED FIVE-YEAR WARRANTY</b> From Date of Purchase	FSP replacement parts for any part of gearcase assembly if defective in materials or workmanship. The gearcase assembly is shown in the "If You Need Assistance Or Service" section of this book. FSP replacement parts for any top and lid rust.
<b>LIMITED TEN-YEAR WARRANTY</b> From Date of Purchase	FSP replacement of outer tub should it crack, or fail to contain water, due to defective materials or workmanship.
<b>WHIRLPOOL WILL NOT PAY FOR</b>	
<p><b>A.</b> Service calls to:</p> <ol style="list-style-type: none"> <li>1. Correct the installation of your washer.</li> <li>2. Instruct you how to use your washer.</li> <li>3. Replace house fuses or correct house wiring or plumbing.</li> </ol> <p><b>B.</b> Repairs when your washer is used in other than normal, single-family household use.</p> <p><b>C.</b> Pickup and delivery. Your washer is designed to be repaired in the home.</p> <p><b>D.</b> Damage to your washer caused by accident, misuse, fire, flood, acts of God or use of products not approved by Whirlpool.</p> <p><b>E.</b> Any labor costs during the limited warranties.</p> <p><b>F.</b> Repairs to parts or systems caused by unauthorized modifications made to the appliance.</p>	

8-92

WHIRLPOOL CORPORATION SHALL NOT BE LIABLE FOR INCIDENTAL OR CONSEQUENTIAL DAMAGES. Some states do not allow the exclusion or limitation of incidental or consequential damages, so this limitation or exclusion may not apply to you. This warranty gives you specific legal rights, and you may also have other rights which vary from state to state.

Outside the United States, a different warranty may apply. For details, please contact your authorized Whirlpool distributor or military exchange.

If you need service, first see the "If You Need Assistance Or Service" section of this book. After checking "If You Need Assistance Or Service," additional help can be found by calling our Consumer Assistance Center telephone number, 1-800-253-1301, from anywhere in the U.S.A.



Printed on recycled paper—  
10% post-consumer waste  
50% recovered materials

**PART NO. 3363547**

© 1994 Whirlpool Corporation

® Registered Trademark of Whirlpool, U.S.A.

Printed in U.S.A.