

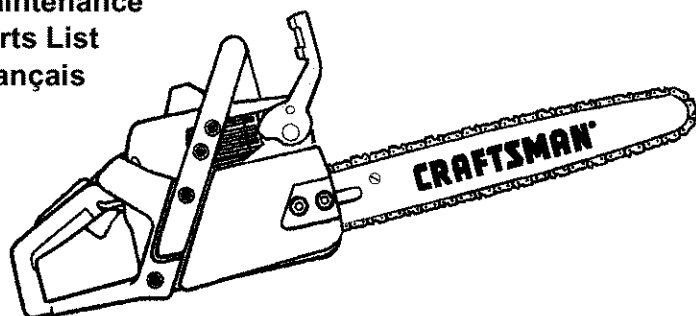

2.2 cu.in./36cc 2-Cycle
GASOLINE CHAIN SAW

Model No.
C944.411364 – 16 in. Bar

- Safety
- Assembly
- Operation
- Maintenance
- Parts List
- Français



For Occasional Use Only



WARNING:
Read and follow all Safety Rules and Operating Instructions before first use of this product.



For answers to your questions about this product:
Call 7 am–7 pm, Mon–Sat; Sun, 10 am–7 pm
1-800-235-5878

Sears Canada, Inc., Toronto, Ontario M5B 2B8

TABLE OF CONTENTS

Warranty Statement	2	Storage	19
Identification of Symbols	2	Troubleshooting Table	20
Safety Rules	3	Emissions Statement	22
Assembly	7	Parts List	24
Operation	8	French	26
Maintenance	14	Parts & Ordering	Back Cover
Service and Adjustments	17		

WARRANTY STATEMENT

LIMITED ONE (1) YEAR WARRANTY FOR CRAFTSMAN® GAS CHAIN SAW

For one (1) year from the date of purchase Sears Canada, Inc., will repair or replace free of charge at Sears option parts which are defective as a result of materials or workmanship.

COMMERCIAL OR RENTAL USE:

If this Gas Chain Saw is used for commercial application the warranty is void.

This warranty does NOT cover:

1. Expendable items which become worn during normal use, such as chain, chain bar, starter rope, spark plugs, and filter.
2. Pre-delivery setup, installation of guide bar and chain.
3. Customer neglect; operating Chain Saw without proper fuel mixture or operating Chain Saw without lubrication.

Warranty service is available by returning the Gas Chain Saw to the nearest Sears Service Centre/Department in Canada. This warranty applies only while this product is in use in Canada.

This warranty is in addition to any statutory warranty and does not exclude or limit legal rights you may have but shall run concurrently with applicable provincial legislation. Furthermore, some provinces do NOT allow limitation on how long an implied warranty will last so the above limitations may not apply to you.

Sears Canada, Inc., Toronto, Ontario M5B 2B8

IDENTIFICATION OF SYMBOLS



WARNING! This chain saw can be dangerous! Careless or improper use can cause serious or even fatal injury.

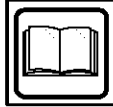

Read and understand the instruction manual before using the chain saw.



Always wear appropriate ear protection, eye protection and head protection.



Measured maximum kick-back value without chain brake for the bar and chain combination on the label.



Always use two hands when operating the chain saw.



WARNING! Contacting the guide bar tip with any object should be avoided; tip contact may cause the guide bar to move suddenly upward and backward, which may cause serious injury.

SAFETY RULES

⚠ WARNING: Always disconnect spark plug wire when making repairs except for carburetor adjustments. Because a chain saw is a high-speed woodcutting tool, special safety precautions must be observed to reduce risk of accidents. Careless or improper use of this tool can cause serious injury.

PLAN AHEAD

- Restrict the use of your saw to adult users who understand and can follow the safety rules, precautions, and operating instructions found in this manual.
- Wear protective gear. Always use steel-toed safety footwear with non-slip soles; snug-fitting clothing; heavy-duty, non-slip gloves; eye protection such as non-fogging, vented goggles or face screen; an approved safety hard hat; and sound barriers (ear plugs or muffs) to protect your hearing. Regular users should have hearing checked regularly as chain saw noise can damage hearing.

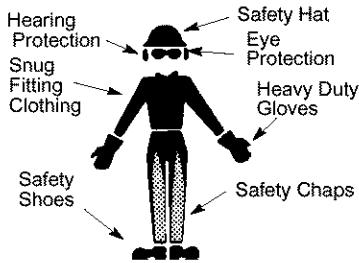

- Secure hair above shoulder length. Do not wear loose clothing or jewelry; they can get caught in moving parts.
- Keep all parts of your body away from the chain when the engine is running.
- Keep children, bystanders, and animals at least 30 feet (10 meters) away from the work area when starting and using the saw.
- Do not handle or operate a chain saw when you are fatigued, ill, or upset, or if you have taken alcohol, drugs, or medication. You must be in good physical condition and mentally alert. If you have any condition that might be aggravated by strenuous work, check with doctor before operating.

- Do not start cutting until you have a clear work area, secure footing, and especially if you are felling a tree, a retreat path.

OPERATE YOUR SAW SAFELY

- Do not operate with one hand. Serious injury to the operator, helpers, or bystanders may result from one-handed operation. A chain saw is intended for two-handed use.
- Operate the chain saw only in a well-ventilated outdoor area.
- Do not operate saw from a ladder or in a tree.
- Make sure the chain will not make contact with any object while starting the engine. Never try to start the saw when the guide bar is in a cut.
- Do not put pressure on the saw, especially at the end of the cut. Doing so can cause you to lose control when the cut is completed.
- Stop engine before setting saw down.
- Hand carry saw only when engine is stopped. Carry with muffler away from body; guide bar & chain projecting behind you; guide bar preferably covered with a scabbard.
- Do not operate a chain saw that is damaged, improperly adjusted, or not completely and securely assembled. Always replace bar, chain, hand guard, chain brake, or other parts immediately if they become damaged, broken, or are otherwise removed.

MAINTAIN YOUR SAW IN GOOD WORKING ORDER

- Have all chain saw service performed by a qualified service dealer except the items listed in the MAINTENANCE section of this manual.
- Make certain the saw chain stops moving when the throttle trigger is released. For correction, refer to CARBURETOR ADJUSTMENTS.
- Keep the handles dry, clean, and free from oil or fuel mixture.
- Keep caps and fasteners securely tightened.
- Nonconforming replacement components or the removal of safety devices may cause damage to the unit and possible injury to the operator or bystanders. Use only Craftsman accessories and replacement parts as recommended. Never modify your saw.

- Maintain chain saw with care.
- Keep unit sharp and clean for better and safer performance.
- Follow instructions for lubricating and changing accessories.
- Check for damaged parts. Before further use of the chain saw, a guard or other part that is damaged should be carefully checked to determine that it will operate properly and perform its intended function. Check for alignment of moving parts, binding of moving parts, breakage of parts, mounting and any other conditions that may affect its operation. A guard or other part that is damaged should be properly repaired or replaced by a Sears Service Centre unless otherwise indicated elsewhere in the instruction manual.
- When not in use, chain saws should be stored in a dry, high or locked-up place out of the reach of children.
- When storing saw, use a scabbard or carrying case.

HANDLE FUEL WITH CAUTION

- Do not smoke while handling fuel or while operating the saw.
- Eliminate all sources of sparks or flame in areas where fuel is mixed or poured.
- Mix and pour fuel in an outdoor area and use an approved, marked container for all fuel purposes. Wipe up all fuel spills before starting saw.
- Move at least 10 feet (3 meters) from fueling site before starting.
- Turn the engine off and let saw cool in a non-combustible area, not on dry leaves, straw, paper, etc. Slowly remove fuel cap and refuel unit.
- Store the unit and fuel in a cool, dry well ventilated space where fuel vapors cannot reach sparks or open flames from water heaters, electric motors or switches, furnaces, etc.

GUARD AGAINST KICKBACK

Follow all safety rules to help avoid kickback and other forces which can result in serious injury.

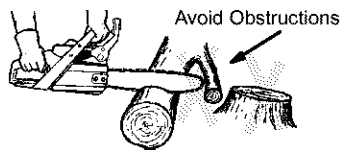
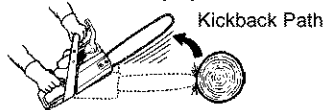

Clear The Working Area

⚠ WARNING: Avoid kickback which can result in serious injury. **Kickback** is the backward, upward or sudden forward motion of the guide bar occurring when the saw chain near the upper tip of the guide bar contacts any object such as a log or branch, or when the wood closes in and pinches the saw chain in the cut. Contacting a foreign object in the wood can also result in loss of chain saw control.

- **Rotational Kickback** can occur when the moving chain contacts an object at the upper tip of the guide bar. This contact can cause the chain to dig into the object, which stops the chain for an instant. The result is a lightning fast, reverse reaction which kicks the guide bar up and back toward the operator.
- **Pinch-Kickback** can occur when the the wood closes in and pinches the moving saw chain in the cut along the top of the guide bar and the saw chain is suddenly stopped. This sudden stopping of the chain results in a reversal of the chain force used to cut wood and causes the saw to move in the opposite direction of the chain rotation. The saw is driven straight back toward the operator.
- **Pull-In** can occur when the moving chain contacts a foreign object in the wood in the cut along the bottom of the guide bar and the saw chain is suddenly stopped. This sudden stopping pulls the saw forward and away from the operator and could easily cause the operator to lose control of the saw.

REDUCE THE CHANCE OF KICKBACK

- Recognize that kickback can happen. With a basic understanding of kickback, you can reduce the element of surprise which contributes to accidents.
- Never let the moving chain contact any object at the tip of the guide bar.

- Keep working area free from obstructions such as other trees, branches, rocks, fences, stumps, etc. Eliminate or avoid any obstruction that your saw chain could hit while cutting.
- When cutting a branch, do not let the guide bar contact another branch or other objects around it.
- Keep saw chain sharp and properly tensioned. A loose or dull chain can increase the chance of kickback. Follow manufacturer's chain sharpening and maintenance instructions. Check tension at regular intervals, but never with engine running. Make sure chain brake nuts are securely tightened.
- Begin and continue cutting at full speed. If the chain is moving at a slower speed, there is greater chance of kickback occurring.
- Use extreme caution when reentering a cut.
- Do not attempt cuts starting with the tip of the bar (plunge cuts).
- Watch for shifting logs or other forces that could close a cut and pinch or fall into chain.
- Use the specified Reduced-Kickback Guide Bar and Low-Kickback Chain.

Avoid Pinch-Kickback:

- Be extremely aware of situations or obstructions that can cause material to pinch the top of or otherwise stop the chain.
- Do not cut more than one log at a time.
- Do not twist saw as bar is withdrawn from an undercut when bucking.

Avoid Pull-In:

- Always begin cutting with the engine at full speed and the saw housing against wood.
- Use wedges made of plastic or wood. Never use metal to hold the cut open.

MAINTAIN CONTROL

Stand to the left of the saw

Thumb on underside of handlebar

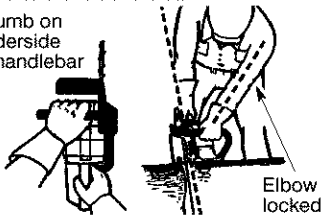

Elbow locked

Never reverse hand positions

- A good, firm grip on the saw with both hands will help you maintain control. Don't let go. Grip the rear

handle with your right hand whether you are right or left handed. Wrap the fingers of your left hand over and around the front handlebar, and your left thumb under the front handlebar. Keep your left arm straight with the elbow locked.

- Position your left hand on the front handlebar so it is in a straight line with your right hand on the rear handle when making bucking cuts. Stand slightly to the left side of the saw to keep your body from being in a direct line with the cutting chain.
- Stand with your weight evenly balanced on both feet.
- Do not overreach. You could be drawn or thrown off balance and lose control.
- Do not cut above shoulder height. It is difficult to maintain control of saw above shoulder height.

KICKBACK SAFETY FEATURES

⚠ WARNING: The following features are included on your saw to help reduce hazard of kickback; however, such features will not totally eliminate this danger. Do not rely only on safety devices. Follow all safety rules to help avoid kickback and other forces which can result in serious injury.

- Front Hand Guard: designed to reduce the chance of your left hand contacting the chain if your hand slips off the front handlebar.
- Position of front and rear handlebars: designed with distance between handles and "in-line" with each other. The spread and "in-line" position of the hands provided by this design work together to give balance and resistance in controlling the pivot of the saw back toward the operator if kickback occurs.
- Reduced-Kickback Guide Bar: designed with a small radius tip which reduces the size of the kickback danger zone. This type bar has been demonstrated to significantly reduce the number and seriousness of kickbacks.

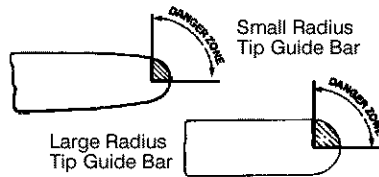

- Low-Kickback Chain: has met kickback performance requirements when tested on a representative sample of chain saws below 3.8 cubic inch displacement.

Low-Kickback Chain

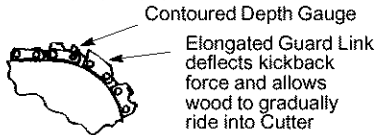

CHAIN BRAKE & CKA ANGLE

- Chain Brake: designed to stop the chain in the event of kickback.

⚠ WARNING: WE DO NOT REPRESENT AND YOU SHOULD NOT ASSUME THAT THE CHAIN BRAKE WILL PROTECT YOU IN THE EVENT OF A KICKBACK. Kickback is a lightning fast action which throws the bar and rotating chain back and up toward the operator. Kickback can be caused by allowing contact of the bar tip in the danger zone with any hard object. Kickback can also be caused by pinching the saw chain along the top of the guide bar. This action may push the guide bar rapidly back toward the operator. Either of these events may cause you to lose control of the saw which could result in serious injury or even death. **DO NOT RELY UPON ANY OF THE DEVICES BUILT INTO YOUR SAW. YOU SHOULD USE THE SAW PROPERLY AND CAREFULLY TO AVOID KICKBACK.** Reduced-kickback guide bars and low-kickback saw chains reduce the chance and magnitude of kickback and are recommended. Your saw has a low kickback chain and bar as original equipment. Repairs on a chain brake should

be made by an authorized Sears Service Centre. Take your unit to the place of purchase or to your nearest Sears Service Centre.

- Tip contact in some cases may cause a lightning fast reverse REACTION, kicking guide bar up and back toward operator.
- Pinching the saw chain along the top of the guide bar may push the guide bar rapidly back toward the operator.
- Either of these reactions may cause you to lose control of the saw which could result in serious injury. Do not rely exclusively upon safety devices built into your saw.

⚠ WARNING: Computed kickback angle (CKA) listed on your saw and listed in the CKA table below represents angle of kickback your bar and chain combinations will have when tested in accordance with CSA (Canadian Standards Association) standards. When purchasing replacement bar and chain, considerations should be given to the lower CKA values. Lower CKA values represent safer angles to the user, higher values indicate more angle and higher kick energies. Computed angle represented indicates total energy and angle associated without activation of the chain brake during kickback. In all cases lower CKA values represent a safer operating environment for the user.

The following guide bar and chain combinations meet kickback requirements of CSA Z62.1 & Z62.3 when used on saws listed in this manual. Use of bar and chain combinations other than those listed is not recommended and may not meet the CKA requirements per standard.

Computed kickback angle (CKA) Table

MODEL	BAR		CHAIN P/N	CKA without chain brake
	P/N	Length		
C944.411364	71-36596	16"	71-3629	19°

SAFETY NOTICE: Exposure to vibrations through prolonged use of gasoline powered hand tools could cause blood vessel or nerve damage in the fingers, hands, and joints of people prone to circulation disorders or abnormal swelling. Prolonged use in cold weather has been linked to blood vessel damage in otherwise healthy people. If symptoms occur such as numbness, pain, loss of strength, change in skin color or texture, or loss of feeling in the fingers, hands, or joints, discontinue the use of this tool and seek medical attention. An anti-vibration system does not guarantee the avoidance of these problems. Users who operate power tools on a continual and regular basis must closely monitor their physical condition and the condition of this tool.

SPARK ARRESTING SCREEN: Your saw is equipped with a temperature limiting muffler and spark arresting screen which meets the requirements of California Codes 4442 and 4443. All U.S. forest land and the states of California, Idaho, Maine, Minnesota, New Jersey, Oregon, and Washington require by law that many internal combustion engines be equipped with a spark arresting screen. If you operate a chain saw in a state or locale where such regulations exist, you are legally responsible for maintaining the operating condition of these parts. Failure to do so is a violation of the law. Refer to CUSTOMER RESPONSIBILITIES TABLE in the MAINTENANCE section.

STANDARDS

CSA Z62.1-03 "Chain Saws – Occupational Health and Safety"

CSA Z62.3-96 "Chain Saw Kickback Occupational Health and Safety"

ASSEMBLY

CARTON CONTENTS

Check carton contents against the following list.

Model C944.411364

- Chain Saw (fully assembled)
- Bar tool
- 2-cycle engine oil (bar oil not included)

Examine parts for damage. Do not use damaged parts.

If you need assistance or find that parts are missing or damaged, please call 1-800-235-5878.

NOTE: It is normal to hear the fuel filter rattle in an empty fuel tank.

Your unit has been factory tested and the carburetor precisely adjusted. As a result you may smell gasoline or find a drop of oil/fuel residue on the muffler when you unpack the unit.

ASSEMBLY

Your saw is fully assembled; no assembly is necessary.

OPERATION

KNOW YOUR SAW

READ THIS INSTRUCTION MANUAL AND SAFETY RULES BEFORE OPERATING YOUR CHAIN SAW. Compare the illustrations with your unit to familiarize yourself with the location of the various controls and adjustments. Save this manual for future reference.

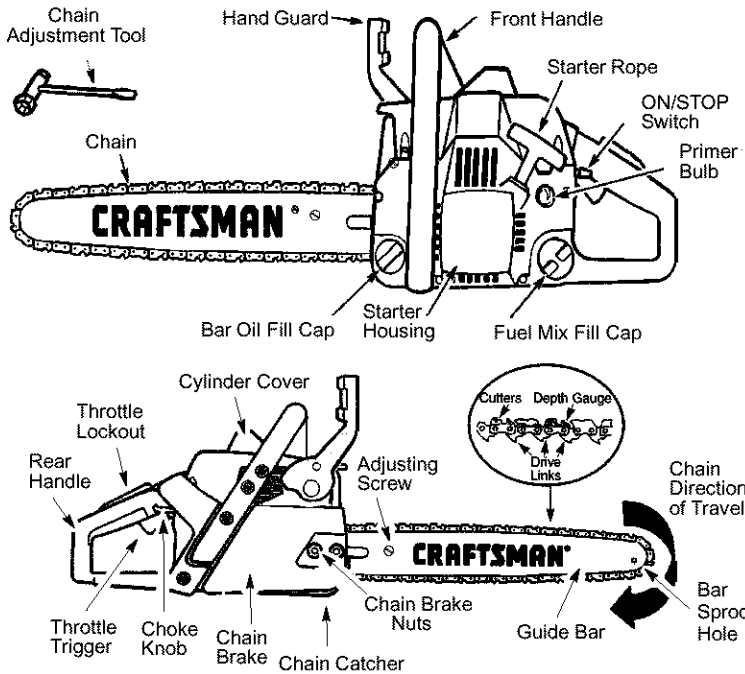

ON/STOP SWITCH

The ON/STOP SWITCH is used to stop the engine.

THROTTLE TRIGGER

The THROTTLE TRIGGER controls engine speed.

THROTTLE LOCK-OUT

The THROTTLE LOCK-OUT must be pressed before you can squeeze the throttle trigger. This feature prevents you from accidentally squeezing the trigger.

CHOKE/FAST IDLE LEVER

The choke and fast idle are set by pulling the CHOKE/FAST IDLE LEVER out fully for cold or after refueling. The choke provides additional fuel to the engine during cold starting.

PRIMER BULB

The PRIMER BULB circulates fuel to the carburetor to provide quicker starting.

CHAIN BRAKE

The CHAIN BRAKE is a device designed to stop the chain if kickback occurs. The chain brake activates automatically in the event of kickback. The chain brake activates manually if the front hand guard is pushed forward. The chain brake is disengaged by pulling the front hand guard back toward the front handle as far as possible.

CHAIN TENSION

It is normal for a new chain to stretch during first 30 minutes of operation. You should check your chain tension frequently. See CHAIN TENSION under the SERVICE AND ADJUSTMENTS section.

⚠ WARNING: Muffler is very hot during and after use. Do not touch the muffler or allow combustible material such as dry grass or fuel to do so.

BEFORE STARTING ENGINE

⚠ WARNING: Be sure to read the fuel handling information in the safety rules section of this manual before you begin. If you do not understand the fuel handling information do not attempt to fuel your unit. Seek help from someone that does understand the information or call the customer assistance help line at 1-800-235-5878.

GUIDE BAR AND CHAIN OIL

The chain oiler provides continuous lubrication to the chain and guide bar. Be sure to fill the bar oil tank when you fill the fuel tank (Capacity = 6.8 fl. oz.). For maximum guide bar and chain life, we recommend you use Craftsman chain saw bar oil. If Craftsman bar oil is not available, you may use a good grade SAE 30 oil until you are able to obtain Craftsman brand. The oil output is automatically metered during operation. Your saw will use approximately one tank of bar oil for every tank of fuel mix. Always fill the bar oil tank when you fill the fuel tank.

FUELING ENGINE

⚠ WARNING: Remove fuel cap slowly when refueling.

This engine is certified to operate on unleaded gasoline. Before operation, gasoline must be mixed with a good quality synthetic 2-cycle air-cooled engine oil. We recommend Craftsman brand synthetic oil. Mix gasoline and oil at a ratio of 40:1. A 40:1 ratio is obtained by mixing 95 ml of oil with 4 litres of unleaded gasoline. Included with this saw is a 95 ml container of Craftsman brand oil. Pour the entire contents of this container into 4 litres of gasoline to achieve the proper fuel mixture. **DO NOT USE** automotive oil or boat oil. These oils will cause engine damage. When mixing fuel follow the instructions printed on the container. Once oil is added to the gasoline, shake container momentarily to assure that the fuel is thoroughly mixed. Always read and follow the safety rules relating to fuel before fueling your unit.

IMPORTANT

Experience indicates that alcohol blended fuels (called gasohol or using ethanol or methanol) can attract moisture which leads to separation and formation of acids during storage. Acidic

gas can damage the fuel system of an engine while in storage.

To avoid engine problems, the fuel system should be emptied before storage for 30 days or longer. Drain the gas tank, start the engine and let it run until the fuel lines and carburetor are empty. Use fresh fuel next season. See STORAGE instructions for additional information.

Never use engine or carburetor cleaner products in the fuel tank or permanent damage may occur.

See the STORAGE section for additional information.

CHAIN BRAKE

Ensure chain brake is disengaged by pulling the front hand guard back toward the front handle as far as possible. The chain brake must be disengaged before cutting with the saw.

⚠ WARNING: The chain must not move when the engine runs at idle speed. If the chain moves at idle speed refer to CARBURETOR ADJUSTMENT within this manual. Avoid contact with the muffler. A hot muffler can cause serious burns.

STOPPING YOUR ENGINE

- Move ON/STOP switch to the STOP position.

STARTING YOUR ENGINE

- To start the engine, hold the saw firmly on the ground as illustrated. Make sure the chain is free to turn without contacting any object.

Starter Rope Handle

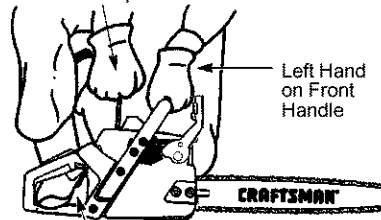

Right Foot Through Rear Handle

Important points to remember

When pulling the starter rope, do not use the full extent of the rope as this can cause the rope to break. Do not let starter rope snap back. Hold the handle and let the rope rewind slowly.

For cold weather starting, start the unit at FULL CHOKE; allow the engine to warm up before squeezing the throttle trigger.

NOTE: DO NOT cut material with the choke/fast idle lever at the FULL CHOKE position.

STARTING A COLD ENGINE (or a warm engine after running out of fuel)

NOTE: In the following steps, when the choke/fast idle lever is pulled out to the full extent, the correct throttle setting for starting is set automatically.

**ON/STOP SWITCH
(SIDE VIEW)**

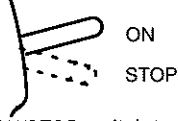

1. Move ON/STOP switch to the ON position.
2. Pull out choke/fast idle to the full extent (to the FULL CHOKE position).
3. Slowly press primer bulb 6 times.
4. Pull the starter rope sharply 5 times with your right hand. Then, proceed to the next step.

NOTE: If the engine sounds as if it is trying to start before the 5th pull, stop pulling and immediately proceed to the next step.

5. Push the choke/fast idle lever in to the HALF CHOKE position.

**CHOKE/FAST IDLE LEVER
(SIDE VIEW)**

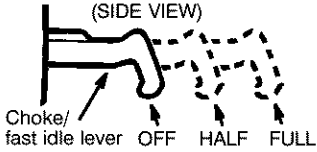

6. Pull the starter rope sharply with your right hand until the engine starts.
7. Allow the engine to run for approximately 5 seconds. Then, squeeze and release throttle trigger to allow engine to return to idle speed.

STARTING A WARM ENGINE

1. Move ON/STOP switch to the ON position.
2. Pull the choke/fast idle lever out to the HALF CHOKE position.
3. Slowly press the primer bulb 6 times.
4. Pull the starter rope sharply with your right hand until the engine starts.
5. Squeeze and release throttle trigger to allow engine to return to idle speed.

DIFFICULT STARTING (or starting a flooded engine)

The engine may be flooded with too much fuel if it has not started after 10 pulls. Flooded engines can be cleared of excess fuel by pushing the choke/fast idle lever in completely (to the OFF CHOKE position) and then following the warm engine starting procedure listed above. Ensure the ON/STOP switch is in the ON position. Starting could require pulling the starter rope handle many times depending on how badly the unit is flooded. If engine fails to start, refer to the TROUBLESHOOTING TABLE or call 1-800-235-5878.

CHAIN BRAKE

WARNING: If the brake band is worn too thin it may break when the chain brake is triggered. With a broken brake band, the chain brake will not stop the chain. The chain brake must be replaced if any part is worn to less than 0.020 inch (0.5 mm) thick. Repairs on a chain brake should be made by your Sears Service Centre. Take your unit to the place of purchase or to the nearest Sears Service Centre.

- This saw is equipped with a chain brake. The brake is designed to stop the chain if kickback occurs.
- The inertia-activated chain brake is activated if the front hand guard is pushed forward, either manually (by hand) or automatically (by sudden movement).
- If the brake is already activated, it is disengaged by pulling the front hand guard back toward the front handle as far as possible.
- When cutting with the saw, the chain brake must be disengaged.

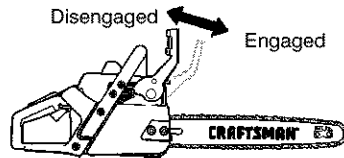

Braking function control

CAUTION: The chain brake must be checked several times daily. The engine must be running when performing this procedure. This is the only instance when the saw should be placed on the ground with the engine running.

Place the saw on firm ground. Grip the rear handle with your right hand and the front handle with your left hand. Apply full throttle by fully depressing the throttle trigger. Activate the chain brake by turning your left wrist against the hand guard without releasing your grip around the front handle. The chain should stop immediately.

Inertia activating function control

⚠ WARNING: When performing the following procedure, the engine must be turned off.

Grip the rear handle with your right hand and the front handle with your left hand. Hold the chain saw approximately 14 inches (35 cm) above a stump or other wooden surface. Release your grip on the front handle and use the weight of the saw to let the tip of the guide bar fall forward and contact the stump. When the tip of the bar hits the stump, the brake should activate.

OPERATING TIPS

- Check chain tension before first use and after 1 minute of operation. See CHAIN TENSION in the MAINTENANCE section.
- Cut wood only. Do not cut metal, plastics, masonry, non-wood building materials, etc.
- Stop the saw if the chain strikes a foreign object. Inspect the saw and repair parts as necessary.
- Keep the chain out of dirt and sand. Even a small amount of dirt will quickly dull a chain and increase the possibility of kickback.
- Practice cutting a few small logs using the following steps. This will help you get the "feel" of using your saw before you begin a major sawing operation.
 - Squeeze the throttle trigger and allow the engine to reach full speed before cutting.
 - Begin cutting with the saw frame against the log.
 - Keep the engine at full speed the entire time you are cutting.
 - Allow the chain to cut for you. Exert only light downward pressure.
 - Release the throttle trigger as soon as the cut is completed, allowing the engine to idle. If you run the saw at full throttle without a cutting load, unnecessary wear can occur.

- To avoid losing control when cut is complete, do not put pressure on saw at end of cut.
- Stop engine before setting saw down.

TREE FELLING TECHNIQUES

⚠ WARNING: Check for broken or dead branches which can fall while cutting causing serious injury. Do not cut near buildings or electrical wires if you do not know the direction of tree fall, nor cut at night since you will not be able to see well, nor during bad weather such as rain, snow, or strong winds, etc.

- Carefully plan your sawing operation in advance.
- Clear the work area. You need a clear area all around the tree so you can have secure footing.
- The chain saw operator should keep on the uphill side of the terrain as the tree is likely to roll or slide downhill after it is felled.
- Study the natural conditions that can cause the tree to fall in a particular direction. These conditions include:
 - The wind direction and speed.
 - The lean of the tree. The lean of a tree might not be apparent due to uneven or sloping terrain. Use a plumb or level to determine the direction of tree lean.
 - Weight and branches on one side.
 - Surrounding trees and obstacles.
- Look for decay and rot. If the trunk is rotted, it can snap and fall toward the operator.
- Make sure there is enough room for the tree to fall. Maintain a distance of 2-1/2 tree lengths from the nearest person or other objects. Engine noise can drown out a warning call.
- Remove dirt, stones, loose bark, nails, staples, and wire from the tree where cuts are to be made.

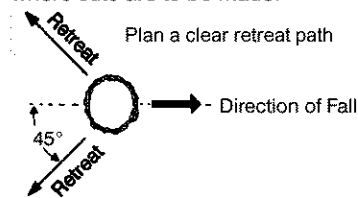

FELLING LARGE TREES

(6 inches in diameter or larger)
 The notch method is used to fell large trees. A notch is cut on the side of the tree in the desired direction of fall. After

a felling cut is made on the opposite side of tree, the tree will tend to fall in the direction of the notch.

NOTE: If tree has large buttress roots, remove them before making the notch. If using saw to remove buttress roots, keep saw chain from contacting ground to prevent dulling of the chain.

NOTCH CUT AND FELLING TREE

- Make notch cut by cutting the top of the notch first. Cut through 1/3 of the diameter of the tree. Next complete the notch by cutting the bottom. See illustration. Once the notch is cut, remove the wedge of wood from tree.

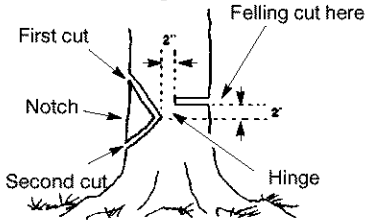

- After removing the wood, make the felling cut on the opposite side of the notch. This is done by making a cut about two inches higher than the Centre of the notch. This will leave enough uncut wood between the felling cut and the notch to form a hinge. This hinge will help prevent the tree from falling in the wrong direction.

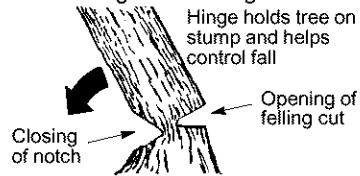

NOTE: Before felling cut is complete, use wedges to open the cut when necessary to control the direction of fall. To avoid kickback and chain damage, use wood or plastic wedges, but never steel or iron wedges.

- Be alert to signs that the tree is ready to fall: cracking sounds, widening of the felling cut, or movement in the upper branches.
- As tree starts to fall, stop saw, put it down, and get away quickly on your planned retreat path.
- DO NOT use your saw to cut down a partially fallen tree. Be extremely cautious with partially fallen trees that may be poorly supported. When a tree doesn't fall completely, set the

saw aside and pull down the tree with a cable winch, block and tackle, or tractor.

CUTTING A FALLEN TREE (BUCKING)

Bucking is the term used for cutting a fallen tree to the desired log size.

WARNING: Do not stand on the log being cut. Any portion can roll causing loss of footing and control. Do not stand downhill of the log being cut.

IMPORTANT POINTS

- Cut only one log at a time.
- Cut shattered wood very carefully; sharp pieces of wood could be flung toward operator.
- Use a sawhorse to cut small logs. Never allow another person to hold the log while cutting and never hold the log with your leg or foot.
- Do not cut in an area where logs, limbs, and roots are tangled. Drag logs into a clear area before cutting them.

BUCKING TECHNIQUES

WARNING: If saw becomes pinched or hung in a log, don't try to force it out. You can lose control of the saw resulting in injury and/or damage to the saw. Stop the saw, drive a wedge of plastic or wood into the cut until the saw can be removed easily. Restart saw and carefully reenter the cut. Do not use a metal wedge. Do not attempt to restart your saw when it is pinched or hung in a log.

Use a wedge to remove pinched saw

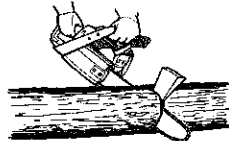

Turn saw OFF and use a plastic or wooden wedge to force cut open.

Overcutting begins on the top side of the log with the bottom of the saw against the log. When overcutting use light downward pressure.



Undercutting involves cutting on the underside of the log with top of saw against the log. When undercutting

use light upward pressure. Hold saw firmly and maintain control. The saw will tend to push back toward you.

⚠ WARNING: Never turn saw upside down to undercut. The saw cannot be controlled in this position.

Always make your first cut on the compression side of the log. The compression side of the log is where the pressure of the log's weight is concentrated.

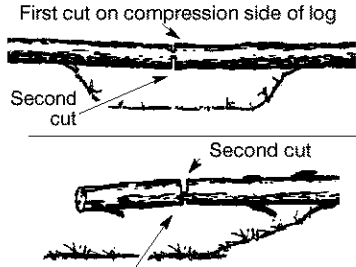

BUCKING WITHOUT A SUPPORT

- Overcut through 1/3 of the diameter of the log.
- Roll the log over and finish with a second overcut.
- Watch for logs with a compression side. See illustrations for cutting logs with a compression side.

BUCKING USING A LOG OR SUPPORT STAND

- Remember your first cut is always on the compression side of the log. (Refer to the illustrations below for your first and second cut).
- Your first cut should extend 1/3 of the diameter of the log.
- Finish with your second cut.

Using a log for support

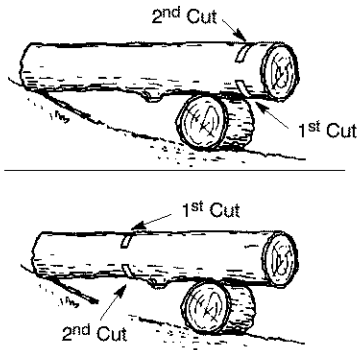

Using a support stand

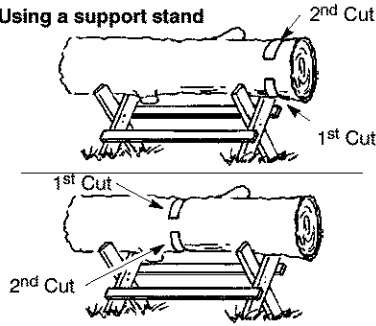

LIMBING AND PRUNING

⚠ WARNING: Be alert for and guard against kickback. Do not allow the moving chain to contact any other branches or objects at the nose of the guide bar when limbing or pruning. Allowing such contact can result in serious injury.

⚠ WARNING: Never climb into a tree to limb or prune. Do not stand on ladders, platforms, a log, or in any position which can cause you to lose your balance or control of the saw.

IMPORTANT POINTS

- Watch out for springpoles. Springpoles are small size limbs which can whip toward you, or pull you off balance. Use extreme caution when cutting small size limbs.
- Be alert for springback. Watch out for branches that are bent or under pressure. Avoid being struck by the branch or the saw when the tension in the wood fibers is released.
- Frequently clear branches out of the way to avoid tripping over them.

LIMBING

- Limb a tree only after it is cut down.
- Leave the larger limbs underneath the felled tree to support the tree as you work.
- Start at the base of the felled tree and work toward the top, cutting branches and limbs. Remove small limbs with one cut.
- Keep the tree between you and the chain.
- Remove larger, supporting branches with the cutting techniques described in BUCKING WITHOUT A SUPPORT.
- Always use an overcut to cut small and freely hanging limbs. Undercutting could cause limbs to fall and pinch the saw.

PRUNING

⚠ WARNING: Limit pruning to limbs shoulder height or below. Do not cut if branches are higher than your shoulder. Get a professional to do the job.

- Make your first cut 1/3 of the way through the bottom of the limb. This cut will make the limb sag so that it falls easily on the second cut.
- Next make a second cut an overcut **all the way through the limb.**
- Finish the pruning operation by using an overcut so that the stump of the limb protrudes 1 to 2 inches from the trunk of the tree.

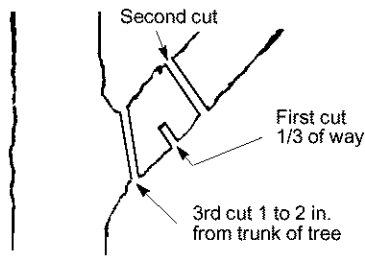

MAINTENANCE

CUSTOMER RESPONSIBILITIES

⚠ WARNING: Disconnect the spark plug before performing maintenance except for carburetor adjustments.

Fill in dates as you complete regular service	Before Use	After Use	Every 5 hrs.	Every 25 hrs.	Yearly	Service Dates
Check for damaged/worn parts	✓					
Check for loose fasteners/parts	✓					
Check chain tension	✓					
Check chain sharpness	✓					
Check guide bar	✓					
Check fuel mixture level	✓					
Check guide bar and chain oil	✓					
Inspect and clean unit & decals		✓				
Check chain brake			✓			
Clean guide bar groove			✓			
Clean air filter			✓			
Clean/inspect muffler and spark arresting screen				✓		
Replace spark plug and fuel filter					✓	

GENERAL RECOMMENDATIONS

The warranty on this unit does not cover items that have been subjected to operator abuse or negligence. To receive full value from the warranty, the operator must maintain unit as instructed in this manual. Various adjustments will need to be made periodically to properly maintain your unit.

- Once a year, replace the spark plug, air filter element, and check guide bar and chain for wear. A new spark plug and air filter element assures proper

air-fuel mixture and helps your engine run better and last longer.

CHECK FOR DAMAGED OR WORN PARTS

Contact Sears Service Centre for replacement of damaged or worn parts.

NOTE: It is normal for a small amount of oil to appear under the saw after engine stops. Do not confuse this with a leaking oil tank.

- ON/STOP Switch - Ensure ON/STOP switch functions properly by moving

the switch to the STOP position. Make sure engine stops; then restart engine and continue.

- Fuel Tank – Do not use saw if fuel tank shows signs of damage or leaks.
- Oil Tank – Do not use saw if oil tank shows signs of damage or leaks.

CHECK FOR LOOSE FASTENERS AND PARTS

- Chain Brake Nuts
- Chain
- Muffler
- Cylinder Shield
- Air Filter
- Handle Screws
- Vibration Mounts
- Starter Housing
- Front Hand Guard

CHECK CHAIN TENSION

⚠ WARNING: Wear protective gloves when handling chain. The chain is sharp and can cut you even when it is not moving.

Chain tension is very important. Chains stretch during use. This is especially true during the first few times you use your saw. Always check chain tension each time you use and refuel your saw.

1. Use the screwdriver end of the chain adjustment tool (bar tool) to move chain around guide bar to ensure kinks do not exist. The chain should rotate freely.

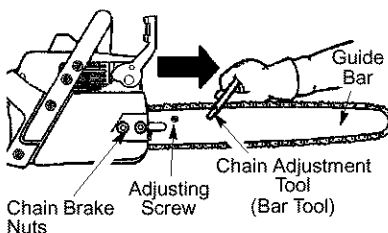

2. Loosen chain brake nuts until they are finger tight against the chain brake.
3. Turn adjusting screw clockwise until chain solidly contacts bottom of guide bar rail.

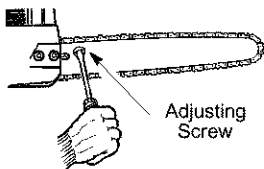

4. Using bar tool, roll chain around guide bar to ensure all links are in bar groove.
5. Lift up tip of guide bar to check for sag. Release tip of guide bar, then turn adjusting screw until sag does not exist.
6. While lifting tip of guide bar, tighten chain brake nuts securely with the bar tool.

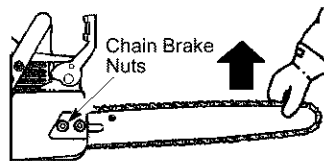

7. Use the screwdriver end of the bar tool to move chain around guide bar.
8. If chain does not rotate, it is too tight. Slightly loosen chain brake nuts and loosen chain by turning the adjusting screw counterclockwise. Retighten chain brake nuts.
9. If chain is too loose, it will sag below the guide bar. DO NOT operate the saw if the chain is loose.

⚠ WARNING: If the saw is operated with a loose chain, the chain could jump off the guide bar and result in serious injury.

CHECK CHAIN SHARPNESS

A sharp chain makes wood chips. A dull chain makes a sawdust powder and cuts slowly. See CHAIN SHARPENING in the SERVICE AND ADJUSTMENTS section.

CHECK GUIDE BAR

Conditions which require guide bar maintenance:

- Saw cuts to one side or at an angle.
- Saw has to be forced through the cut.
- Inadequate supply of oil to bar/chain.

Check the condition of guide bar each time chain is sharpened. A worn guide bar will damage the chain and make cutting difficult.

After each use, ensure ON/STOP switch is in the STOP position, then clean all sawdust from the guide bar and sprocket hole.

To maintain guide bar:

- Move ON/STOP switch to STOP.
- Loosen and remove chain brake nuts and chain brake. Remove bar and chain from saw.
- Clean the oil holes and bar groove after each 5 hours of operation.

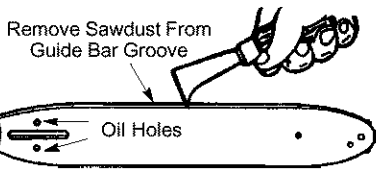

- Burring of guide bar rails is a normal process of rail wear. Remove these burrs with a flat file.
- When rail top is uneven, use a flat file to restore square edges and sides.

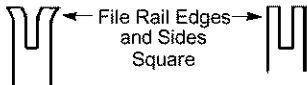

Replace guide bar when the groove is worn, the guide bar is bent or cracked, or when excess heating or burring of the rails occurs. If replacement is necessary, use only the guide bar specified for your saw in the repair parts list or on the decal located on the chain saw.

CHECK FUEL MIXTURE LEVEL

- See FUELING ENGINE under the OPERATION section.

LUBRICATION

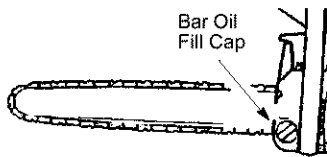

- See GUIDE BAR AND CHAIN OIL under the OPERATION section.

INSPECT AND CLEAN UNIT AND DECALS

- After each use, inspect complete unit for loose or damaged parts. Clean the unit and decals using a damp cloth with a mild detergent.
- Wipe off unit with a clean dry cloth.

CHECK CHAIN BRAKE

- See CHAIN BRAKE in the OPERATION section.

CLEAN AIR FILTER

A dirty air filter decreases the life and performance of the engine and increases fuel consumption and harmful emissions. Always clean your air filter after 15 tanks of fuel or 5 hours of operation, whichever comes first. Clean more frequently in dusty conditions. A used air filter can never be completely

cleaned. It is advisable to replace your air filter with a new one after every 50 hours of operation, or annually, whichever comes first. To clean filter:

1. Loosen 3 screws on cylinder cover.
2. Remove cylinder cover.
3. Remove air filter.
4. Clean the air filter using hot soapy water. Rinse with clean cool water. Air dry completely before reinstalling.
5. Lightly oil air filter before installing to improve the efficiency of air filter. Use 2-cycle engine oil or motor oil (SAE 30). Squeeze excess oil from filter.
6. Reinstall air filter.
7. Reinstall cylinder cover and 3 screws. Tighten securely.

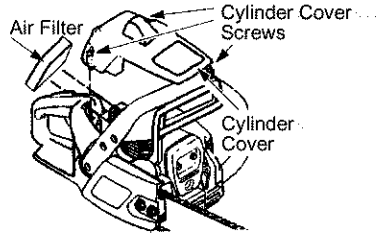

INSPECT MUFFLER AND SPARK ARRESTING SCREEN

As the unit is used, carbon deposits build up on the muffler and spark arresting screen, and must be removed to avoid creating a fire hazard or affecting engine performance. Replace the spark arresting screen if breaks occur.

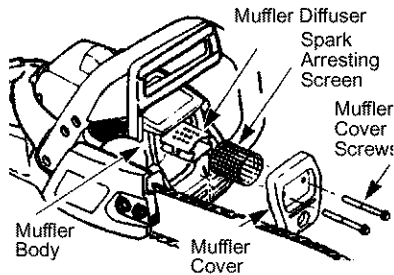

CLEANING THE SPARK ARRESTING SCREEN

Cleaning is required every 25 hours of operation or annually, whichever comes first.

1. Loosen and remove the 2 muffler cover screws.
2. Remove the muffler cover (cover snaps off muffler body).

3. Remove muffler diffuser and spark arresting screen assembly. Notice the orientation of parts for reassembly.
4. Clean the spark arresting screen with a wire brush. Replace screen if breaks are found.
5. Replace any broken or cracked muffler parts.
6. Reinstall diffuser and spark arresting screen assembly with round holes facing up.
7. Reinstall muffler cover and 2 screws. Tighten securely.

REPLACE SPARK PLUG

The spark plug should be replaced each year to ensure the engine starts easier and runs better. Ignition timing is fixed and nonadjustable.

1. Loosen 3 screws on cylinder cover.
2. Remove the cylinder cover.
3. Pull off the spark plug boot.
4. Remove spark plug from cylinder and discard.

5. Replace with Champion CJ-7Y spark plug and tighten securely with a 3/4 inch socket wrench. Spark plug gap should be 0.025 in.
6. Reinstall the spark plug boot.
7. Reinstall the cylinder cover and 3 screws. Tighten securely.

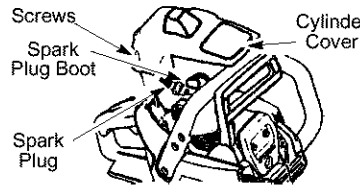

REPLACE FUEL FILTER

To replace the fuel filter, drain your unit by running it dry of fuel. Remove fuel cap and its connected retainer from tank. Pull filter from tank and remove from line. Replace and reassemble.

SERVICE AND ADJUSTMENTS

⚠ WARNING: Disconnect the spark plug before performing maintenance, service, or adjustments except for carburetor adjustments.

CHAIN SHARPENING

Chain sharpening requires special tools. You can purchase sharpening tools at Sears or go to a professional chain sharpener.

CHAIN REPLACEMENT

⚠ WARNING: Wear protective gloves when handling chain. The chain is sharp and can cut you even when it is not moving.

It is normal for a new chain to stretch during the first 15 minutes of operation. You should recheck your chain tension frequently and adjust the chain tension as required. See CHAIN TENSION section.

Replace the old chain when it becomes worn or damaged. Use only the Low-Kickback replacement chain specified in the repair parts list. The correct replacement bar and chain is also specified on a decal located on the chain saw.

See your Sears Service Centre to replace and sharpen individual cutters on your chain.

TO REPLACE CHAIN:

1. Move ON/STOP switch to the STOP position.
2. Remove chain brake nuts.
3. Remove chain brake.

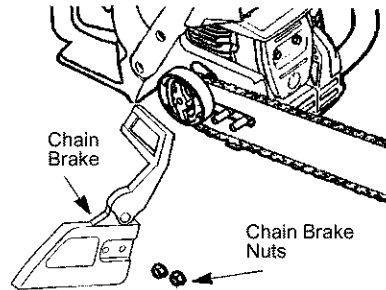

4. Turn adjusting screw on bar counterclockwise to move the tensioning rack as far as it will go toward the front of the bar.

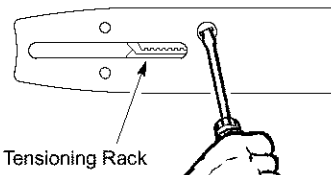

5. Slide guide bar behind clutch drum until guide bar stops against clutch drum sprocket.

6. Remove the old chain.
7. Carefully remove new chain from package. Hold chain with the drive links as shown.

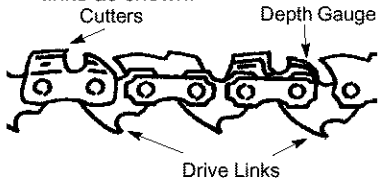

8. Place chain over and behind clutch, fitting the drive links into the clutch drum sprocket.
9. Fit bottom of drive links between the teeth in the sprocket in the nose of the guide bar.
10. Fit chain drive links into bar groove.
11. Pull guide bar forward until chain is snug in the guide bar groove. Ensure all drive links are in the bar groove.
12. Install the chain brake.
13. Install chain brake nuts; finger tighten only. Do not tighten any further at this point. Proceed to CHAIN ADJUSTMENT.

CHAIN ADJUSTMENT

See CHAIN TENSION in MAINTENANCE section.

CARBURETOR ADJUSTMENT

⚠ WARNING: The chain will be moving during most of this procedure. Wear your protective equipment and observe all safety precautions. The chain must not move at idle speed. The carburetor has been carefully set at the factory. Adjustments may be necessary if you notice any of the following conditions:

- Chain moves at idle. See IDLE SPEED-T adjusting procedure.
- Saw will not idle. See IDLE SPEED-T adjusting procedure.

Idle Speed-T

Allow engine to idle. If the chain moves, idle is too fast. If the engine stalls, idle is too slow. Adjust speed until engine runs without chain movement (idle too fast) or stalling (idle too slow). The idle speed screw is located in the area above the primer bulb and is labeled T.

- Turn idle screw (T) clockwise to increase engine speed.
- Turn idle screw (T) counterclockwise to decrease engine speed.

If you require further assistance or are unsure about performing this procedure, contact your Sears Service Center or call our customer assistance help line at 1-800-235-5878.

STORAGE

⚠ WARNING: Perform the following steps after each use:

- Allow the engine to cool, and secure the unit before storing or transporting.
- Store chain saw and fuel in a well ventilated area where fuel vapors cannot reach sparks or open flames from water heaters, electric motors or switches, furnaces, etc.
- Store chain saw with all guards in place and position chain saw so that any sharp object cannot accidentally cause injury.
- Store chain saw well out of the reach of children.

SEASONAL STORAGE

Prepare your unit for storage at the end of the season or if it will not be used for 30 days or more.

If your chain saw is to be stored for a period of time:

- Clean saw thoroughly before storage.
- Store in a clean dry area.
- Lightly oil external metal surfaces and guide bar.
- Oil the chain and wrap it in heavy paper or cloth.

FUEL SYSTEM

Under FUELING ENGINE in the OPERATION section of this manual, see message labeled **IMPORTANT** regarding the use of gasohol in your chain saw.

Fuel stabilizer is an acceptable alternative in minimizing the formation of fuel gum deposits during storage. Add stabilizer to the gasoline in the fuel tank or fuel storage container. Follow the mix instructions found on stabilizer containers. Run engine at least 5 minutes after adding stabilizer.

Craftsman 40:1, 2-cycle engine oil (air cooled) is especially blended with fuel stabilizer. If you do not use this Sears oil, you can add a fuel stabilizer to your fuel tank.

ENGINE

- Remove spark plug and pour 1 teaspoon of 40:1, 2-cycle engine oil (air cooled) through the spark plug opening. Slowly pull the starter rope 8 to 10 times to distribute oil.
- Replace spark plug with new one of recommended type and heat range.
- Clean air filter.
- Check entire unit for loose screws, nuts, and bolts. Replace any damaged, broken, or worn parts.
- At the beginning of the next season, use only fresh fuel having the proper gasoline to oil ratio.

OTHER

- Do not store gasoline from one season to another.
- Replace your gasoline can if it starts to rust.

TROUBLESHOOTING TABLE

⚠ WARNING: Always stop unit and disconnect spark plug before performing all of the recommended remedies below except remedies that require operation of the unit.

TROUBLE	CAUSE	REMEDY
Engine will not start or will run only a few seconds after starting.	<ol style="list-style-type: none"> 1. ON/STOP switch in STOP position. 2. Engine flooded. 3. Fuel tank empty. 4. Spark plug not firing. 5. Fuel not reaching carburetor. 6. Carburetor requires adjustment. 7. None of the above. 	<ol style="list-style-type: none"> 1. Move ON/STOP switch to ON. 2. See "Difficult Starting" in the Operation Section. 3. Fill tank with correct fuel mixture. 4. Install new spark plug. 5. Check for dirty fuel filter; replace. Check for kinked or split fuel line; repair or replace. 6. Contact Sears Service (see back cover). 7. Contact Sears Service (see back cover).
Engine will not idle properly.	<ol style="list-style-type: none"> 1. Idle speed set too high or too low. 2. Low Speed Mixture requires adjustment. 3. Crankshaft seals worn. 4. Compression low. 5. None of the above. 	<ol style="list-style-type: none"> 1. See "Carburetor Adjustment" in the Service and Adjustments Section. 2. Contact Sears Service (see back cover). 3. Contact Sears Service (see back cover). 4. Contact Sears Service (see back cover). 5. Contact Sears Service (see back cover).
Engine will not accelerate, lacks power, or dies under a load.	<ol style="list-style-type: none"> 1. Air filter dirty. 2. Spark plug fouled. 3. Carburetor requires adjustment. 4. Exhaust ports or muffler outlets plugged. 5. Compression low. 6. Chain brake engaged. 7. None of the above. 	<ol style="list-style-type: none"> 1. Clean or replace air filter. 2. Clean or replace plug and regap. 3. Contact Sears Service (see back cover). 4. Contact Sears Service (see back cover). 5. Contact Sears Service (see back cover). 6. Disengage chain brake. 7. Contact Sears Service (see back cover).
Engine smokes excessively.	<ol style="list-style-type: none"> 1. Choke partially on. 2. Fuel mixture incorrect. 3. Air filter dirty. 4. High Speed Mixture requires adjustment. 5. Crankcase leak. 	<ol style="list-style-type: none"> 1. Adjust choke. 2. Empty fuel tank and refill with correct fuel mixture. 3. Clean or replace air filter. 4. Contact Sears Service (see back cover). 5. Contact Sears Service (see back cover).
Engine runs hot.	<ol style="list-style-type: none"> 1. Fuel mixture incorrect. 2. Spark plug incorrect. 3. High Speed Mixture set too lean. 4. Exhaust ports or muffler outlets plugged. 5. Carbon build-up on spark arresting screen. 6. Starter housing dirty. 7. None of the above. 	<ol style="list-style-type: none"> 1. See "Fueling Engine" in the Operation section. 2. Replace with correct plug. 3. Contact Sears Service (see back cover). 4. Contact Sears Service (see back cover). 5. Clean spark arresting screen. 6. Clean starter housing area. 7. Contact Sears Service (see back cover).

TROUBLESHOOTING TABLE - Continued

TROUBLE	CAUSE	REMEDY
Oil inadequate for bar and chain lubrication.	<ol style="list-style-type: none"> 1. Oil tank empty. 2. Oil pump or oil filter clogged. 3. Guide bar oil hole blocked. 	<ol style="list-style-type: none"> 1. Fill oil tank. 2. Contact Sears Service (see back cover). 3. Remove bar and clean.
Chain moves at idle speed.	<ol style="list-style-type: none"> 1. Idle speed requires adjustment. 2. Clutch requires repair. 	<ol style="list-style-type: none"> 1. See "Carburetor Adjustment" in the Service and Adjustments Section. 2. Contact Sears Service (see back cover).
Chain does not move when engine is accelerated.	<ol style="list-style-type: none"> 1. Chain tension too tight. 2. Carburetor requires adjustment. 3. Guide bar rails pinched. 4. Clutch slipping. 5. Chain brake engaged. 	<ol style="list-style-type: none"> 1. See "Check Chain Tension" in the Maintenance Section. 2. Contact Sears Service (see back cover). 3. Repair or replace. 4. Contact Sears Service (see back cover). 5. Disengage chain brake.
Chain clatters or cuts roughly.	<ol style="list-style-type: none"> 1. Chain tension incorrect. 2. Cutters damaged. 3. Chain worn. 4. Cutters dull, improperly sharpened, or depth gauges too high. 5. Sprocket worn. 6. Chain installed backwards. 	<ol style="list-style-type: none"> 1. See "Check Chain Tension" in the Maintenance Section. 2. Contact Sears Service (see back cover). 3. Resharpener or replace chain. 4. See "Chain Sharpening" in the Service and Adjustments Section. 5. Contact Sears Service (see back cover). 6. Install chain in right direction.
Chain stops within the cut.	<ol style="list-style-type: none"> 1. Chain cutter tops not filed flat. 2. Guide bar burred or bent; rails uneven. 3. Clutch slipping. 	<ol style="list-style-type: none"> 1. See "Chain Sharpening" in the Service and Adjustments Section. 2. Repair or replace guide bar. 3. Contact Sears Service (see back cover).
Chain cuts at an angle.	<ol style="list-style-type: none"> 1. Cutters damaged on one side. 2. Chain dull on one side. 3. Guide bar bent or worn. 	<ol style="list-style-type: none"> 1. See "Chain Sharpening" in the Service and Adjustments Section. 2. See "Chain Sharpening" in the Service and Adjustments Section. 3. Replace guide bar.

If situations occur which are not covered in this manual, use care and good judgement. If you need assistance, contact Sears Service or the CUSTOMER ASSISTANCE HELPLINE at 1-800-235-5878.

**U.S. EPA / ENVIRONMENT CANADA
EMISSION CONTROL WARRANTY STATEMENT**

YOUR WARRANTY RIGHTS AND OBLIGATIONS: The U. S. Environmental Protection Agency/Environment Canada and Sears Canada, Inc., are pleased to explain the emissions control system warranty on your year 2002-2004 small off-road engine. Sears Canada must warrant the emission control system on your small off-road engine for the periods of time listed below provided there has been no abuse, neglect, or improper maintenance of your small off-road engine. Your emission control system includes parts such as the carburetor and the ignition system. Where a warrantable condition exists, Sears Canada will repair your small off-road engine at no cost to you. Expenses covered under warranty include diagnosis, parts and labor. **MANUFACTURER'S WARRANTY COVERAGE:** If any emissions related part on your engine (as listed under Emissions Control Warranty Parts List) is defective or a defect in the materials or workmanship of the engine causes the failure of such an emission related part, the part will be repaired or replaced by Sears Canada. **OWNER'S WARRANTY RESPONSIBILITIES:** As the small off-road engine owner, you are responsible for the performance of the required maintenance listed in your instruction manual. Sears Canada recommends that you retain all receipts covering maintenance on your small off-road engine, but Sears Canada cannot deny warranty solely for the lack of receipts or for your failure to ensure the performance of all scheduled maintenance. As the small off-road engine owner, you should be aware that Sears Canada may deny you warranty coverage if your small off-road engine or a part of it has failed due to abuse, neglect, improper maintenance, unapproved modifications, or the use of parts not made or approved by the original equipment manufacturer. You are responsible for presenting your small off-road engine to a Sears Canada authorized repair center as soon as a problem exists. Warranty repairs should be completed in a reasonable amount of time, not to exceed 30 days. If you have any

questions regarding your warranty rights and responsibilities, you should contact your nearest authorized service center or call Sears Canada at 1-800-665-4455. **WARRANTY COMMENCEMENT DATE:** The warranty period begins on the date the small off-road engine is purchased. **LENGTH OF COVERAGE:** This warranty shall be for a period of two years from the initial date of purchase. **WHAT IS COVERED: REPAIR OR REPLACEMENT OF PARTS.** Repair or replacement of any warranted part will be performed at no charge to the owner at an approved Sears Canada servicing center. If you have any questions regarding your warranty rights and responsibilities, you should contact your nearest authorized service center or call Sears Canada at 1-800-665-4455. **WARRANTY PERIOD:** Any warranted part which is not scheduled for replacement as required maintenance, or which is scheduled only for regular inspection to the effect of "repair or replace as necessary" shall be warranted for 2 years. Any warranted part which is scheduled for replacement as required maintenance shall be warranted for the period of time up to the first scheduled replacement point for that part. **DIAGNOSIS:** The owner shall not be charged for diagnostic labor which leads to the determination that a warranted part is defective if the diagnostic work is performed at an approved Sears Canada servicing center. **CONSEQUENTIAL DAMAGES:** Sears Canada may be liable for damages to other engine components caused by the failure of a warranted part still under warranty. **WHAT IS NOT COVERED:** All failures caused by abuse, neglect, or improper maintenance are not covered. **ADD-ON OR MODIFIED PARTS:** The use of add-on or modified parts can be grounds for disallowing a warranty claim. Sears Canada is not liable to cover failures of warranted parts caused by the use of add-on or modified parts. **HOW TO FILE A CLAIM:** If you have any questions regarding your warranty rights and responsibilities, you should contact your nearest authorized service center or call Sears Canada at

1-800-665-4455. **WHERE TO GET WARRANTY SERVICE:** Warranty services or repairs shall be provided at all Sears Canada service centers. Call 1-800-665-4455. **MAINTENANCE, REPLACEMENT AND REPAIR OF EMISSION RELATED PARTS:** Any Sears Canada approved replacement part used in the performance of any warranty maintenance or repair on emis-

sion related parts will be provided without charge to the owner if the part is under warranty. **EMISSION CONTROL WARRANTY PARTS LIST:** Carburetor, Ignition System: Spark Plug (covered up to maintenance schedule), Ignition Module. **MAINTENANCE STATEMENT:** The owner is responsible for the performance of all required maintenance as defined in the instruction manual.

The information on the product label indicates which standard your engine is certified. Example: (Year) EPA Phase 1 or Phase 2 and/or CALIFORNIA.

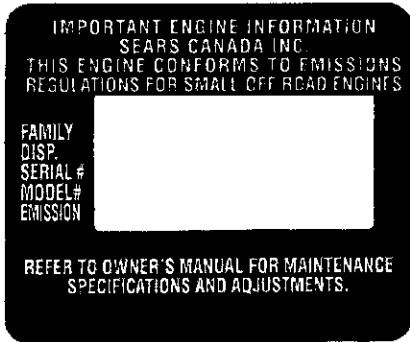

This engine is certified to be emissions compliant for the following use:

- Moderate (50 hours)
- Intermediate (125 hours)
- Extended (300 hours)

Dear Customer,
in manufacturing this product, many steps have been taken to provide you with the highest quality. Unfortunately, errors or omissions occasionally occur. In the event that you find a missing or defective part, please contact your nearest Sears store.

SERVICE AND REPAIR PARTS
CALL 1-800-665-4455*

Keep this number handy should you require a service call or need to order repair parts. If ordering parts make sure you have the name, make and model no. of the merchandise and the name and number of the part you wish to order.

* If calling locally, please use one of the following numbers:

Regina - 566-5124	Montreal - 333-5740
Toronto - 744-4900	Halifax - 454-2444
Kitchener - 894-7590	Ottawa - 738-4440
Vancouver - 420-8211	