



HOW TO MAKE A HOME RUN.™

Use And Care

G U I D E

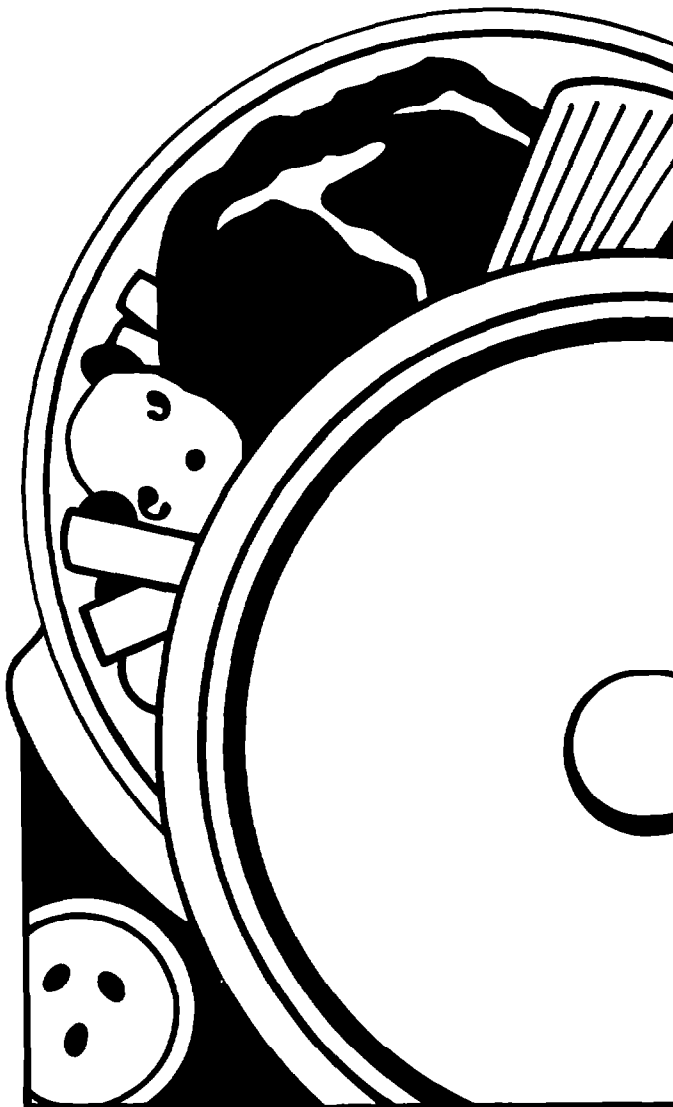

Table of Contents (complete)	2
A Note to You	3
Microwave Oven Safety	4
Installation Instructions	9
Getting to Know Your Microwave Oven	11
Using Your Microwave Oven	18
Caring for Your Microwave Oven	27
Cooking Guide	28
Questions and Answers	31
Troubleshooting	32
Requesting Assistance or Service	34
Index	35
Warranty	36

1-800-253-1301

Call us with questions or comments.

MICROWAVE OVEN

MODELS MT7076XD MT7078XD
MT7116XD MT7118XD

Table of Contents

A Note to You	3	Cooking at different cook powers	19
Microwave Oven Safety	4	Cooking with more than one cook cycle	21
Important safety instructions	4	Using BAKED POTATOES	22
Precautions to avoid possible exposure to excessive microwave energy	6	Using POPCORN	23
Operating safety precautions	7	Using FROZEN ENTREE	24
Installation Instructions	9	Using DEFROST	25
Getting to Know Your Microwave Oven	11	Defrosting Tips	26
How your microwave oven works	11	Caring for Your Microwave Oven	27
Microwave oven features	13	Cooking Guide	28
Control panel features	14	Reheating tips	28
Setting the clock	16	Microwave cooking tips	29
Using ADD MINUTE	17	Questions and Answers	31
Using Your Microwave Oven	18	Troubleshooting	32
Getting the best cooking results	18	Requesting Assistance or Service	34
Cooking at high cook power	18	Index	35
		Warranty	36

A Note to You

Thank you for buying a WHIRLPOOL® appliance.

Because your life is getting busier and more complicated, WHIRLPOOL microwave ovens are easy to use, save time, and help you manage your home better. To ensure that you enjoy years of trouble-free operation, we developed this Use and Care Guide. It is full of valuable information about how to operate and maintain your appliance properly and safely. Please read it carefully.

Also, please complete and mail in the Ownership Registration Card provided with your appliance. The card helps us notify you about any new information on your appliance.

Please record your model's information.

Whenever you call to request service for your appliance, you need to know your complete model number and serial number. You can find this information on the model and serial number plate (see diagram on page 13 for location of plate).

Please also record the purchase date of your appliance and your dealer's name, address, and telephone number.

Model Number _____

Serial Number _____

Purchase Date _____

Dealer Name _____

Dealer Address _____

Dealer Phone _____

Keep this book and the sales slip together in a safe place for future reference.

**Our Consumer Assistance Center
number is toll-free 24 hours a day.**

1-800-253-1301

Microwave Oven Safety

Your safety is important to us.

This guide contains safety statements under warning symbols. Please pay special attention to these symbols and follow any instructions given. Here is a brief explanation of the use of the symbol.

⚠ WARNING

This symbol will help alert you to such dangers as fire, electrical shock, burns, and personal injury.

IMPORTANT SAFETY INSTRUCTIONS

Microwave ovens have been thoroughly tested for safe and efficient operation. However, as with any appliance, there are special installation and safety precautions which must be followed to ensure safe and satisfactory operation and prevent damage to the unit.

⚠ WARNING

To reduce the risk of fire, electrical shock, burns, injury to persons, exposure to excessive microwave energy, or damage when using the microwave oven, follow basic precautions, including the following:

- Read all instructions before using the microwave oven.
- Read and follow the specific "PRECAUTIONS TO AVOID POSSIBLE EXPOSURE TO EXCESSIVE MICROWAVE ENERGY" found on page 6.
- This appliance must be grounded. Connect only to properly grounded outlet. See "GROUNDING INSTRUCTIONS" found on page 10.
- Install or locate this appliance only in accordance with the provided Installation Instructions found on page 9.
- Some products such as whole eggs in the shell and sealed containers – for example, closed glass jars – could explode and should not be heated in this oven.
- Do not heat, store, or use flammable materials in or near the oven. Fumes could create a fire hazard or explosion.
- Use this appliance only for its intended use as described in this manual. Do not use corrosive chemicals or vapors in this appliance. This type of oven is specifically designed to heat or cook food. It is not designed for industrial or laboratory use.
- As with any appliance, close supervision is necessary when used by children.
- Do not operate this appliance if it has a damaged cord or plug, if it is not working properly, or if it has been damaged or dropped. Electrical shock, fire, or other hazards could result.
- This appliance should be serviced only by qualified service personnel. Call an authorized Whirlpool service company for examination, repair, or adjustment.
- Do not cover or block any opening on the appliance. Fire could result.
- Do not store or use this appliance outdoors. Do not use this product near water – for example, near a kitchen sink, in a wet basement, or near a swimming pool, and the like.
- Do not immerse cord or plug in water.
- Keep cord away from heated surfaces.
- Do not let cord hang over edge of table or counter.
- See door surface and interior cleaning instructions on page 27.

MICROWAVE OVEN SAFETY

• To reduce the risk of fire in the oven cavity:

- Do not overcook food. Carefully attend appliance if paper, plastic, or other combustible materials are placed inside the oven to facilitate cooking. Paper could char or burn, and some plastics could melt if used when heating foods.
- Do not deep fry in oven. Microwavable utensils are not suitable and it is difficult to maintain appropriate deep frying temperatures.

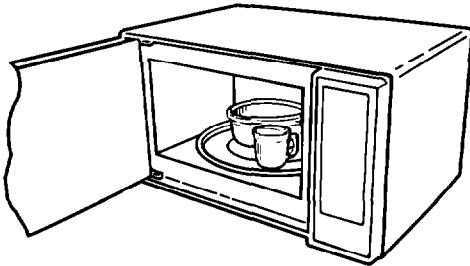

- **Test dinnerware or cookware before using.** To test a dish for safe use, put it into the oven with a cup of water beside it. Cook at 100% cook power for one minute. **If the dish gets hot and water stays cool, do not use it.** Some dishes (melamine, some ceramic dinnerware, etc.) absorb microwave energy, becoming too hot to handle and slowing cooking times. Cooking in metal containers not designed for microwave use could damage the oven, as could containers with hidden metal (twist-ties, foil lining, staples, metallic glaze or trim).
- Remove wire twist-ties from paper or plastic bags before placing bag in oven.

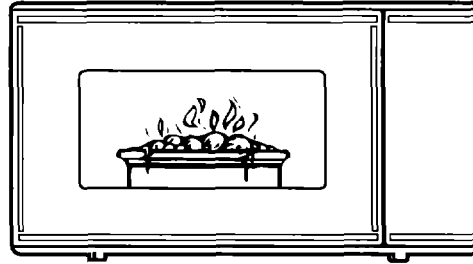

- If materials inside the oven should ignite, keep oven door closed, turn oven off, and disconnect the power cord or shut off power at the fuse or circuit breaker panel.

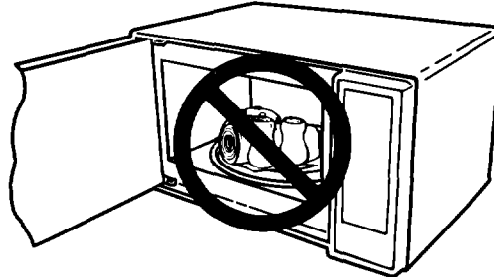

- Do not use the cavity for storage purposes. Do not leave paper products, cooking utensils, or food in the cavity when not in use.
 - Do not operate any heating or cooking appliance beneath this appliance.
 - Do not mount unit over or near any portion of a heating or cooking appliance.
 - Do not mount over a sink.
 - Do not store anything directly on top of the appliance when appliance is in operation.
- Read and follow "Operating safety precautions" starting on page 7.
1. A short power-supply cord is provided to reduce the risks resulting from becoming entangled in or tripping over a longer cord.
 2. Longer cord sets or extension cords are available and may be used if care is exercised in their use.

continued on next page

MICROWAVE OVEN SAFETY

3. If a long cord or extension cord is used temporarily, (a) the marked electrical rating of the cord set or extension cord should be at least as great as the electrical rating of the appliance, (b) the extension cord must be a grounding-type, 3-wire cord that has a 3-blade grounding plug and a 3-slot receptacle that will accept the plug on the appliance, and (c) the longer cord should be arranged so that it will not drape over the countertop or table-top where it can be pulled on by children or tripped over accidentally.
4. A qualified electrician must install a properly grounded and polarized 3-prong receptacle near the appliance.

– SAVE THESE INSTRUCTIONS –

PRECAUTIONS TO AVOID POSSIBLE EXPOSURE TO EXCESSIVE MICROWAVE ENERGY...

Do not attempt to operate this oven with the door open since open-door operation can result in harmful exposure to microwave energy. It is important not to defeat or tamper with the safety interlocks.

Do not place any object between the oven front face and the door or allow soil or cleaner residue to accumulate on sealing surfaces.

Do not operate the oven if it is damaged. It is particularly important that the oven door close properly and that there is no damage to the:

- (1) Door (bent),
- (2) Hinges and latches (broken or loosened),
- (3) Door seals and sealing surfaces.

Do not operate the microwave oven if the door window is broken.

The microwave oven should be checked for microwave leakage by qualified service personnel after a repair is made.

The oven should not be adjusted or repaired by anyone except properly qualified service personnel.

Do not operate the microwave oven with the outer cabinet removed.

Operating safety precautions

⚠ WARNING

To reduce the risk of fire, electrical shock, burns, injury to persons, or damage when using the microwave oven, follow the precautions on pages 7-8.

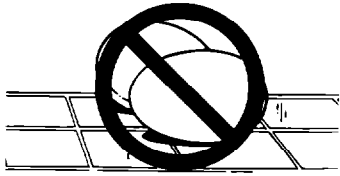

Never cook or reheat a whole egg inside the shell. Steam buildup in whole eggs may cause them to burst and burn you, and possibly damage the oven. **Slice** hard-boiled eggs before heating. In rare instances, poached eggs have been known to explode. **Cover** poached eggs and **allow** a standing time of one minute before cutting into them.



Stir before heating

For best results, stir any liquid several times before heating or reheating. Liquids heated in certain containers (especially cylindrical containers) may become overheated. The liquid may splash out with a loud noise during or after heating or when adding ingredients (coffee granules, tea bags, etc.) resulting in harm to the oven and possible personal injury.



Never lean on the door or allow a child to swing on it when the door is open. Injury could result.

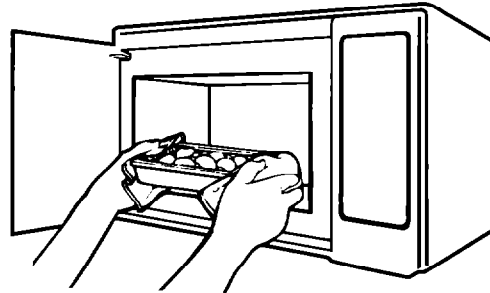

Use hot pads. Microwave energy does not heat containers, but the hot food does.

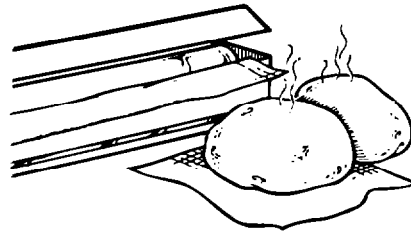

Do not overcook potatoes. Fire could result. At the end of the recommended cooking time, potatoes should be slightly firm because they will continue cooking during standing time. **After microwaving, wrap** potatoes in foil and **set aside** for 5 minutes. They will finish cooking while standing.

continued on next page

MICROWAVE OVEN SAFETY

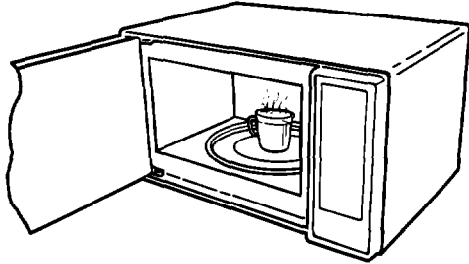

Do not start a microwave oven when it is empty. Product life may be shortened. If you practice programming the oven, **put** a container of water in the oven.

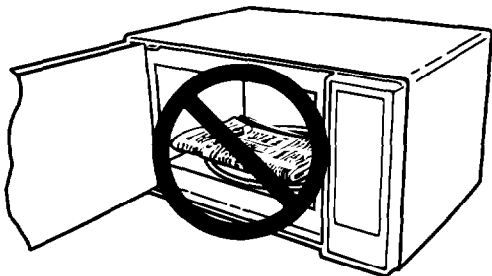

Do not use newspaper or other printed paper in the oven. Fire could result. **Do not** dry flowers, fruit, herbs, wood, paper, gourds, or clothes in the oven. Fire could result.



Do not try to melt paraffin wax in the oven. Paraffin wax will not melt in a microwave oven because it allows microwaves to pass through it.

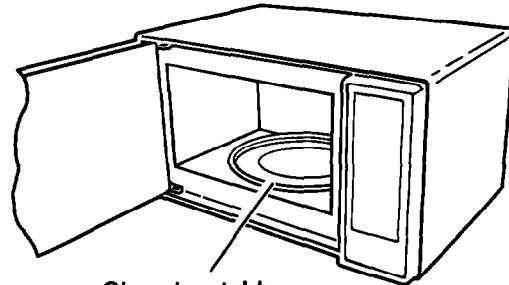

Glass turntable

Do not operate in the microwave mode unless the glass turntable is securely in place and can rotate freely. The turntable can rotate in either direction.

Make sure the turntable is correct-side up in oven. **Carefully place** cookware on turntable to avoid possible breakage.

Handle turntable with care when removing from oven to avoid possible breakage. If turntable cracks or breaks, contact your Whirlpool dealer for a replacement.

When you use a browning dish, the browning dish bottom must be at least $\frac{3}{16}$ inch above the turntable. Follow directions supplied with browning dish.

General information

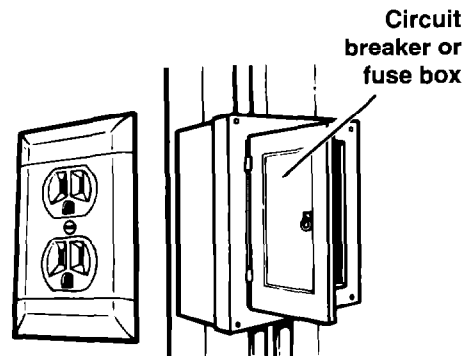

If your electric power line or outlet voltage is less than 110 volts, cooking times may be longer. Have a qualified electrician check your electrical system.

Installation Instructions

Before you begin operating the oven, carefully read the following instructions.

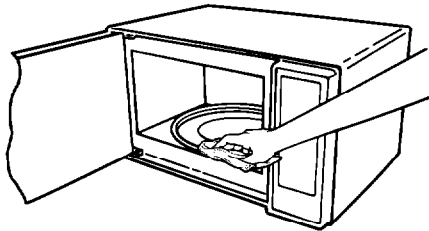

1. **Empty** the microwave oven and **clean** inside it with a soft, damp cloth. **Check** for damage such as misaligned door, damage around the door, or dents inside the oven or on the exterior. If there is any damage, do not operate the unit until it has been checked by an authorized Whirlpool service technician and any repairs made.

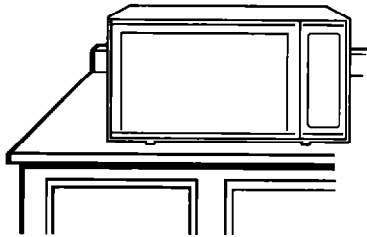

2. **Put** the oven on a cart, counter, table, or shelf that is strong enough to hold the oven and the food and utensils you put in it. **(The control side of the unit is the heavy side. Use care when handling.)** The weight of Models MT7076XD and MT7078XD is about 34 lbs. The weight of Models MT7116XD and MT7118XD is about 44 lbs. The microwave oven should be at a temperature above 50°F (10°C) for proper operation.

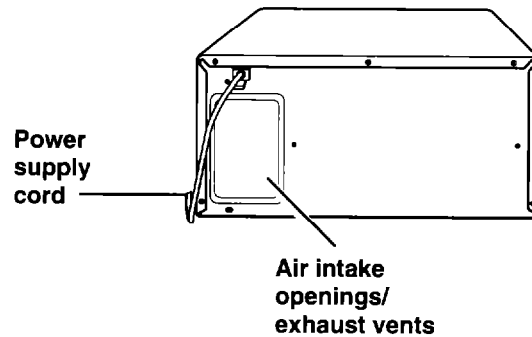

NOTE: Do not block the exhaust vents or rear air intake openings. Allow a few inches of space at back of oven where intake openings are located. Blocking the air intake openings and exhaust vents could cause damage to the oven and poor cooking results. Make sure the microwave oven legs are in place to ensure proper airflow. If vents are blocked, a sensitive thermal safety device automatically turns the oven off. The oven will not work until it has cooled enough.

⚠ WARNING

Fire Hazard

Do not install the oven next to or over a heat source (for example, a cooktop or range). Also, do not install oven in any area where excessive heat and steam are generated.

Failure to follow the above could result in fire, electrical shock, other personal injury, excessive exposure to microwave energy, or damage to the outside of the cabinet.

continued on next page

INSTALLATION INSTRUCTIONS

3. Electrical requirements

Observe all governing codes and ordinances. A 120 Volt, 60 Hz, AC only, 15 amp fused electrical supply is required.

(Time-delay fuse is recommended.) It is recommended that a separate circuit serving only this appliance be provided.

4. GROUNDING INSTRUCTIONS

⚠ WARNING

Electrical Shock Hazard

Improper use of the grounding plug can result in a risk of electrical shock. **DO NOT, UNDER ANY CIRCUMSTANCES, REMOVE THE POWER SUPPLY CORD GROUNDING PRONG.**

5. For your personal safety, this appliance must be grounded. In the event of an electrical short circuit, grounding reduces the risk of electrical shock by providing an escape wire for the electric current. This appliance is equipped with a polarized 3-prong grounding plug. It must be plugged into a correctly polarized mating 3-prong grounding type wall receptacle, properly installed and grounded in accordance with the National Electrical Code and local codes and ordinances. If a mating wall receptacle is not available or if you are not sure if the wall receptacle is properly grounded and polarized, have it checked by a qualified electrician.

3-prong grounding
type wall receptacle

3-prong grounding
plug

Power
supply cord

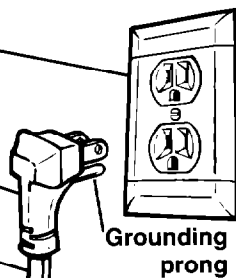

It is the personal responsibility and obligation of the customer to have a properly grounded and correctly polarized 3-prong wall receptacle installed by a qualified electrician.

Consult a qualified electrician if the grounding instructions are not completely understood, or if doubt exists as to whether the appliance is properly grounded.

It is not recommended to use an extension cord with your microwave oven, but if you find it necessary to do so temporarily (until a properly grounded and polarized, 3-prong receptacle is installed), use only a heavy duty, UL listed, 3-wire grounding type extension cord containing three 16-gauge (minimum) copper wires. It must not be longer than 10 feet (cords longer than 10 feet may affect the cooking performance of your microwave oven). The plug on the extension cord must fit into a 3-prong grounding type wall receptacle (as shown on this page) and the receptacle end of the extension cord must accept the 3-prong grounding plug of the microwave oven.

6.  To test the oven, plug it into the proper electrical outlet. Put about one cup (250 mL) of cold water in a glass container in the oven. Close the door. Make sure it latches. Follow the directions on page 18 to set the oven to cook for 2 minutes. When the time is up, the water should be heated.

7. **This microwave oven is designed for use in the household only and must not be used for commercial purposes.**

Do not remove the door, control panel, or cabinet at any time. The unit is equipped with high voltage and should be serviced by an authorized Whirlpool service technician.

- SAVE THESE INSTRUCTIONS -

Getting to Know Your Microwave Oven

This section discusses the concepts behind microwave cooking and introduces you to the basics you need to know to operate your microwave oven. Please read this information before use.

How your microwave oven works

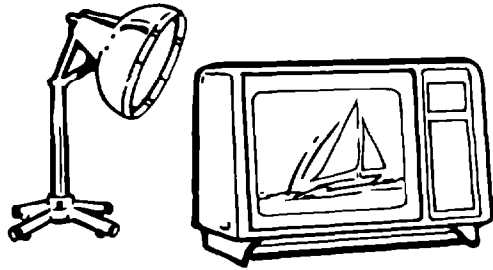

Microwave ovens are safe. Microwave energy is not hot. It causes food to make its own heat, and it's this heat that cooks the food.

Microwaves are like TV waves or light waves. You cannot see them, but you can see what they do.

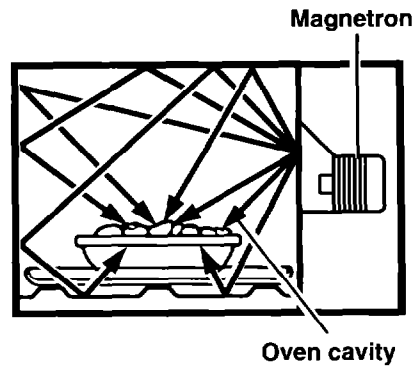

A magnetron in the microwave oven produces microwaves. The microwaves move into the oven where they contact food as it turns on the turntable.

GETTING TO KNOW YOUR MICROWAVE OVEN

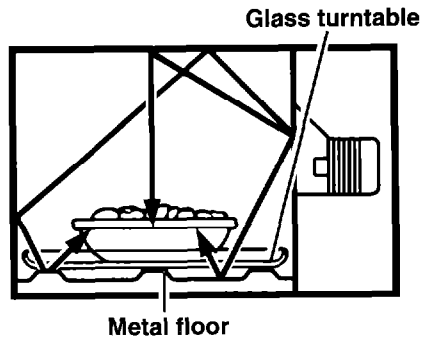

The **glass turntable** of your microwave oven lets microwaves pass through. Then they bounce off a metal floor, back through the glass turntable, and are absorbed by the food.

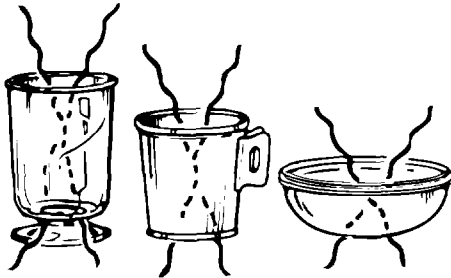

Microwaves pass through most glass, paper, and plastics without heating them so food absorbs the energy. Microwaves bounce off metal containers so food does not absorb the energy.

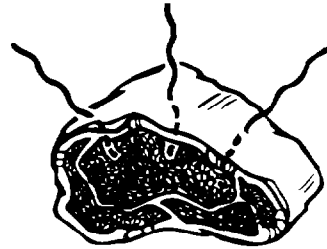

Microwaves may not reach the center of a roast. The heat spreads to the center from the outer, cooked areas just as in regular oven cooking. This is one of the reasons for letting some foods (for example, roasts or baked potatoes) stand for a while after cooking, or for stirring some foods during the cooking time.

The microwaves disturb water molecules in the food. As the molecules bounce around bumping into each other, heat is made, like rubbing your hands together. This is the heat that does the cooking.

Radio interference

Operation of the microwave oven may cause interference to your radio, TV, or similar equipment. When there is interference, it may be reduced or eliminated by taking the following measures:

- **Clean** door and sealing surfaces of the oven.
- **Adjust** the receiving antenna of radio or television.
- **Move** the receiver away from the microwave oven.
- **Plug** the microwave oven into a different outlet so that the microwave oven and receiver are on different branch circuits.

Microwave oven features

(Models MT7076XD and MT7116XD shown - your model may have different styling)

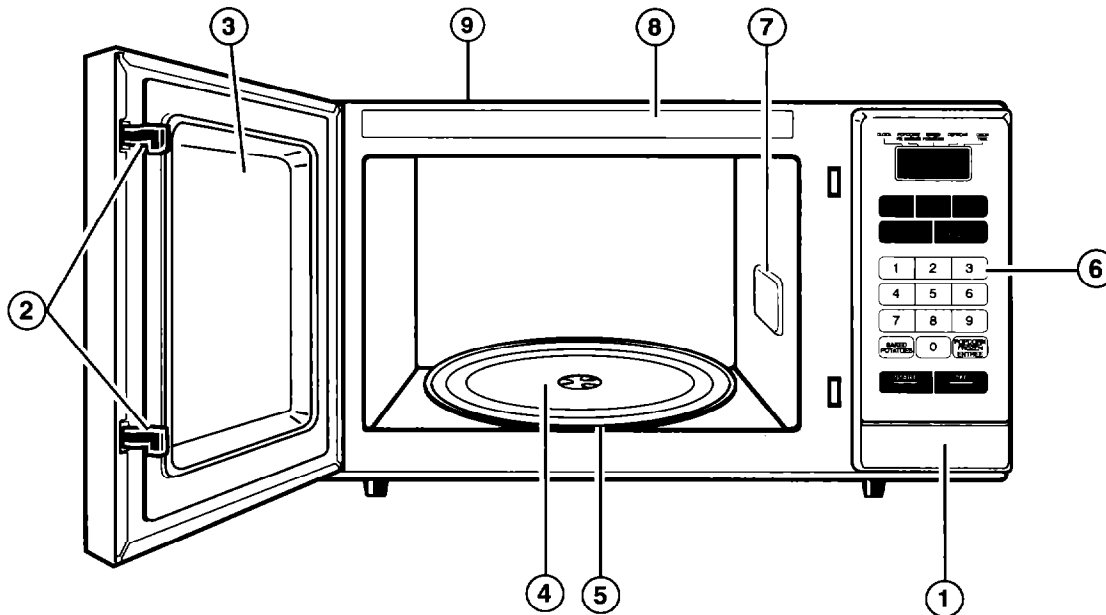

Your microwave oven is designed to make your cooking experience as enjoyable and productive as possible. To get you up and running quickly, the following is a list of the oven's basic features:

1. **One-Touch Door Open Button.** Push to open door.
2. **Door Safety Lock System.** The oven will not operate unless the door is securely closed.
3. **Window with Metal Shield.** Shield prevents microwaves from escaping. It is designed as a screen to allow you to view food as it cooks.
4. **Glass Turntable.** This turntable turns food as it cooks for more even cooking. It must be in the oven during operation for best cooking results. See pages 8, 12, and 27 for more details.
5. **Turntable Support** (under turntable).
6. **Control Panel.** Touch pads on this panel to perform all functions. See pages 14 and 15 for more information.
7. **Light.** Automatically turns on when door is opened or when oven is operating.
8. **Cooking Guide Label.**
9. **Model and Serial Number Plate** (on back).

Control panel features

Your microwave oven control panel lets you select the desired cooking function quickly and easily. All you have to do is touch the necessary Command Pad. The following is a list of all the Command and Number Pads located on the control panel. For more information, see pages 16-25.

1. **Display.** This display includes a clock and indicators to tell you time of day, cooking time settings, and cooking functions.
2. **COOK TIME.** Touch this pad followed by Number Pads to enter cooking times. See pages 18, 20, or 21 for more information.
3. **COOK POWER.** Touch this pad followed by a Number Pad to set the amount of microwave energy released to cook the food. The higher the number, the higher the power or "cooking speed." See page 19 for more information.
4. **CLOCK.** Touch this pad to enter the correct time of day. See page 16 for more information.
5. **DEFROST.** Touch this pad followed by Number Pads to thaw frozen food. See page 25 for more information.
6. **ADD MINUTE.** Touch this pad to cook for one minute at 100% cook power or to add an extra minute to your cooking cycle. See page 17 for more information.
7. **Number Pads.** Touch Number Pads to enter cooking times and cook information.
8. **BAKED POTATOES.** Touch this pad to cook 2 or 3 baking potatoes (up to 16 oz total weight) in your microwave oven. The oven will automatically cook for a preset time at a preset cook power. See page 22 for more information.

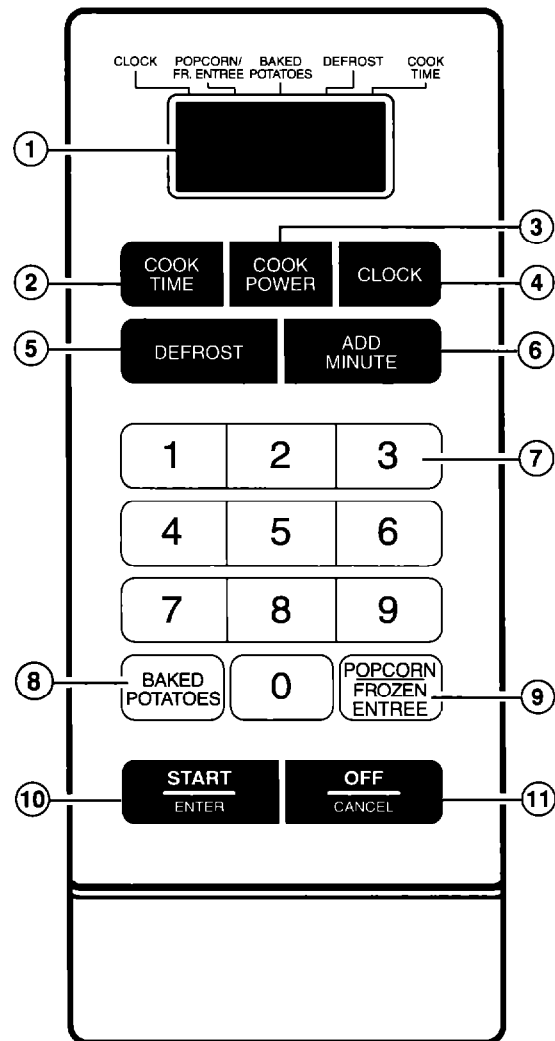

(Models MT7076XD and MT7116XD shown – your model may have different styling)

GETTING TO KNOW YOUR MICROWAVE OVEN

9. **POPCORN/FROZEN ENTREE.** Touch this pad to pop a 3.5 oz bag of commercially packaged microwave popcorn or to cook an 8 to 12 oz frozen entree in your microwave oven. See pages 23 and 24 for more information.
10. **START/ENTER.** Touch this pad to start a function that you have set. If you open the door after the oven begins to cook, retouch START/ENTER.
11. **OFF/CANCEL.** Touch this pad to erase an incorrect command or to cancel a program during cooking. This pad will not erase time of day.

NOTES:

- **If you touch** two Command Pads for the same cycle (for example, BAKED POTATOES and POPCORN), the second command will cancel the first.
- **If you attempt** to enter unacceptable instructions, "Erro" will appear on the Display. Touch OFF/CANCEL and re-enter the instructions.

Audible signals

Audible signals are available to guide you when setting and using your oven:

- **A programming tone will sound** each time you touch a pad.
- **Five tones** signal the end of a cooking cycle.

Interrupting cooking

You can stop the oven during a cycle by opening the door. The oven stops heating and the fan stops, but the light stays on.

To restart cooking, close the door and

TOUCH

A rectangular button with a white background. The word "START" is written in bold black text at the top, and "ENTER" is written in smaller black text below it, separated by a thin horizontal line.

If you do not want to continue cooking:

- **Close** the door and the light goes off.

OR

- **TOUCH**

A rectangular button with a white background. The word "OFF" is written in bold black text at the top, and "CANCEL" is written in smaller black text below it, separated by a thin horizontal line.

NOTE: Before setting a function, touch OFF/CANCEL to make sure no other function is on.

Setting the clock

When your microwave oven is first plugged in, or after a power failure, the Display will show "88:88". If a time of day is not set, "88:88" will stay on the Display until you set the cooking time.

NOTES:

- **You can** only set the clock if the oven is not cooking food.
- **If you enter** an incorrect time, "Erro" will appear on the Display. Touch CLOCK and enter the correct time.
- **If you touch** OFF/CANCEL while setting the clock, the clock will be cleared and the Display will go blank.
- **The colon ":"** will blink once the time of the day is set.

To set time:

1. Choose setting.

TOUCH

YOU SEE



CLOCK

":0"

2. Enter time of day.

Example for 5:30:

TOUCH

YOU SEE



5

"5:30"



3



0

3. Touch clock.

TOUCH

YOU SEE



CLOCK

"5:30"

Using ADD MINUTE

ADD MINUTE lets you cook food for one minute at 100% cook power or add an extra minute to your current cooking cycle. You can also use it to extend cooking time in multiples of one minute, up to 99 minutes.

NOTES:

- **To extend** cooking time in multiples of one minute, touch ADD MINUTE repeatedly during cooking.
- **You cannot use** ADD MINUTE with the POPCORN/FROZEN ENTREE or BAKED POTATOES pads.
- **If you touch** ADD MINUTE during cooking, the oven will cook at the currently selected cook power.

1. Make sure food is in oven and door is closed.

2. Choose setting.

TOUCH

YOU SEE



ADD
MINUTE

“1:00”

once for one
minute

TOUCH

YOU SEE



ADD
MINUTE

“2:00”

a second time for
two minutes

TOUCH

YOU SEE



ADD
MINUTE

“3:00”

a third time for
three minutes

3. Start oven.

TOUCH

YOU SEE



START
ENTER

“3:00”
(example for 3 minutes)

Using Your Microwave Oven

This section gives you instructions for operating each microwave function. Please read these instructions carefully.

Getting the best cooking results

- **ALWAYS** cook food for the minimum recommended cooking time. If necessary, touch ADD MINUTE while the oven is operating (see page 17). Then **check** for doneness to avoid overcooking the food.
- **Stir, turn over, or rearrange food** being cooked about halfway through the cook time for most even doneness with all recipes.
- **If a glass cover is not available, use** wax paper, paper towels, or microwave-approved plastic wrap. **Turn back** a corner to vent steam during cooking.
- **Although a new rating method*** rates this oven at 850 watts, you may use a reliable cookbook and recipes developed for microwave ovens previously rated at 700-800 watts.

*IEC-705 Test Procedure. The IEC-705 Test Procedure is an internationally recognized method of rating microwave wattage output and does not represent an actual change to output power or cooking performance.

Cooking at high cook power

1. Put food in oven and close door.

2. Set cooking time.

TOUCH



YOU SEE

“:0”

Example for 1 minute, 30 seconds:

TOUCH

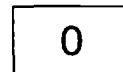
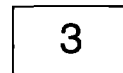
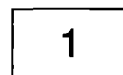

YOU SEE

“1:30”

3. Start oven.

TOUCH



YOU SEE

cooking time
counting down

At end of cooking time:
Five tones will sound.

YOU SEE

“END”
followed by
time of day

Cooking at different cook powers

For best results, some recipes call for different cook powers. The lower the cook power, the slower the cooking. Each Number Pad also stands for a different percentage of cook power. Many microwave cookbook recipes tell you by number, percent, or name which cook power to use.

The following chart gives the percentage of cook power each Number Pad stands for, and the cook power name usually used. It also tells you when to use each cook power. Follow recipe or food package instructions if available.

NOTE: Refer to a reliable cookbook for cooking times and power levels.

COOK POWER	NAME	WHEN TO USE IT
Automatic 100% of full power	High	<ul style="list-style-type: none"> • Quick heating many convenience foods and foods with high water content, such as soups and beverages • Cooking tender cuts of meat, ground meat, poultry pieces, fish fillets, and vegetables
9=90% of full power		<ul style="list-style-type: none"> • Heating cream soups
8=80% of full power		<ul style="list-style-type: none"> • Heating rice, pasta, or casseroles
7=70% of full power	Medium-High	<ul style="list-style-type: none"> • Cooking and heating foods that need a cook power lower than high (for example, whole fish and meat loaf) or when food is cooking too fast • Reheating a single serving of food
6=60% of full power		<ul style="list-style-type: none"> • Cooking requiring special care, such as cheese and egg dishes, pudding, and custards • Finishing cooking casseroles
5=50% of full power	Medium	<ul style="list-style-type: none"> • Cooking ham, whole poultry, and pot roasts • Melting chocolate
4=40% of full power		<ul style="list-style-type: none"> • Simmering stews • Heating pastries
3=30% of full power	Medium-Low, Defrost	<ul style="list-style-type: none"> • Defrosting foods, such as bread, fish, meats, poultry, and precooked foods
2=20% of full power		<ul style="list-style-type: none"> • Softening butter, cheese, and ice cream
1=10% of full power	Low	<ul style="list-style-type: none"> • Keeping food warm • Taking chill out of fruit

USING YOUR MICROWAVE OVEN

1. Put food in oven and close door.

2. Set cooking time.

TOUCH



YOU SEE

“:0”

Example for 7 minutes, 30 seconds:

TOUCH

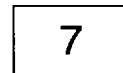

YOU SEE

“7:30”

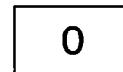
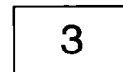

3. Set cook power.

TOUCH



YOU SEE

“P-10”

Example for 50% cook power:

TOUCH

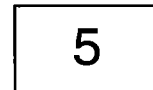

YOU SEE

“P-5”

4. Start oven.

TOUCH



YOU SEE

cooking time
counting down

At end of cooking time:
Five tones will sound.

YOU SEE

“END”
followed by
time of day

**To see cook power during
cooking:**

TOUCH



YOU SEE

“P-5”
(example for 50%
cook power)

Cooking with more than one cook cycle

For best results, some recipes call for one cook power for a certain length of time, and another cook power for another length of time. Your oven can be set to change from one to another automatically, for up to 4 cycles.

NOTE: Refer to a reliable cookbook for cooking times and power levels.

1. Put food in oven and close door.

2. Set cooking time for first cycle.

TOUCH

YOU SEE



“:0”

Example for 7 minutes, 30 seconds:

TOUCH

YOU SEE

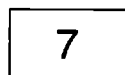

“7:30”

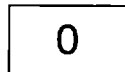
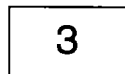

3. Set cook power for first cycle.

TOUCH

YOU SEE



“P-10”

Example for 50% cook power:

TOUCH

YOU SEE

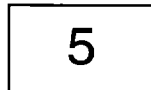

“P-5”

4. Repeat Steps 2 and 3 to set cooking time and cook power for each additional cycle.

continued on next page

USING YOUR MICROWAVE OVEN

5. Start oven.

TOUCH

START
ENTER

YOU SEE

cooking time counting down for first cycle followed by cooking time for next cycle(s)

At end of cooking time:

Five tones will sound.

YOU SEE

“END” followed by time of day

Changing instructions

You can change times or cook power for a cycle any time after that cycle starts by repeating Steps 2 and/or 3.

Using BAKED POTATOES

Your microwave oven cooks 2 or 3 baking potatoes (up to 16 oz total weight) by automatically choosing baking time and cook power. Before baking, remember to pierce potato with a fork several times. After cooking, let potato stand 5 minutes wrapped in foil.

NOTE: If more time is needed do not touch the BAKED POTATOES pad again. Set a short cooking time. (See page 18.)

1. Put pierced potatoes on paper towel in oven and close door.

2. Choose setting.

TOUCH

BAKED
POTATOES

YOU SEE

“PO”

3. Start oven.

TOUCH

START
ENTER

YOU SEE

“7:00”

At end of cooking time:

Five tones will sound.

YOU SEE

“END” followed by time of day

Using POPCORN

POPCORN lets you pop a 3.5 oz bag of commercially packaged microwave popcorn by touching just two pads. Pop only one package at a time. If you are using a microwave popcorn popper, follow manufacturer's instructions. Cooking performance may vary with brand. Try several brands to decide which gives best popping results. For best results, use fresh bags of popcorn.

NOTES:

- **DO NOT unfold** bag when popping 3.0 to 3.5 oz bags of popcorn because in small size oven cavity, bag can become stuck between turntable and oven wall.
- **To pop** a 3.0 oz (light) bag of popcorn, do not use the POPCORN/FROZEN ENTREE pad. Cook at high power for approximately 2:00 minutes.
- **To pop** a 1.5 to 1.75 oz bag of popcorn, do not use the POPCORN/FROZEN ENTREE pad. Cook at high power for approximately 1:30 minutes.

1. Place bag in center of turntable and close door.

⚠ WARNING

Fire Hazard

Do not repop unpopped kernels and do not reuse popcorn bags.

If you remove the turntable right after popping popcorn, use oven mitts.

Failure to follow the above could result in fire or burns.

2. Choose setting.

TOUCH	YOU SEE
	<p>"PC" (for popcorn)</p>
once	

3. Start oven.

TOUCH	YOU SEE
	<p>"2:30"</p>
	<p>YOU SEE</p> <p>"END" followed by time of day</p>

At end of popping time:
Five tones will sound.

Using FROZEN ENTREE

FROZEN ENTREE lets you cook a frozen entree between 8 and 12 oz by touching the POPCORN/FROZEN ENTREE pad twice.

NOTES:

- **If more time is needed** do not touch the POPCORN/FROZEN ENTREE pad again. Set a short cooking time. (See page 18.)
- **Follow** manufacturer's guidelines for preparation of the frozen entree.

1. Place frozen entree on turntable and close door.

2. Choose setting.

TOUCH



twice

YOU SEE

"PI"
(for frozen entree)

3. Start oven.

TOUCH



YOU SEE

"5:00"

At end of cooking time:
Five tones will sound.

YOU SEE

"END"
followed by
time of day

Using DEFROST

Your microwave oven lets you defrost food by simply entering defrosting time. A 30% cook power is preset.

NOTE: Refer to a reliable cookbook for defrosting times and power levels.

1. Put frozen food in oven and close door.

2. Choose setting.

TOUCH

YOU SEE

DEFROST

“:0”

3. Enter defrosting time.

TOUCH

YOU SEE

1	0
0	0

“10:00”

4. Start oven.

TOUCH

YOU SEE

START
ENTER

defrosting time
counting down

At end of defrosting time:
Five tones will sound.

YOU SEE
“END”
followed by
time of day

Defrosting tips

- **Before starting**, make sure you have removed any of the metal twist-ties which often come with frozen food bags, and replace them with strings or elastic bands.
- **Open containers** such as cartons before they are placed in the oven.
- **Always slit** or pierce plastic pouches or packaging.
- **If food is foil wrapped**, remove foil and place it in a suitable container.
- **Slit** the skins, if any, of frozen food such as sausage.
- **Bend** plastic pouches of food to ensure even defrosting.
- **Always underestimate** defrosting time. If defrosted food is still icy in the center, return it to the microwave oven for more defrosting.
- **The length** of defrosting time varies according to how solidly the food is frozen.
- **The shape of the package** alters the defrosting time. Shallow, rectangular packets defrost more quickly than a deep block.
- **Separate pieces** as they begin to defrost. Separated pieces defrost more easily.
- **You can use small pieces** of aluminum foil to shield foods like chicken wings, leg tips, and fish tails, but the foil must not touch the side of the oven. Foil can damage the oven lining.
- **Shield areas of food** with small pieces of foil if they start to become warm.
- **For better results**, let food stand after defrosting. (For more information on standing time, see "Microwave cooking tips" on page 29.)
- **Turn over** food during defrosting or standing time.

Caring for Your Microwave Oven

To make sure your microwave oven looks good and works well for a long time, you should maintain it properly. For proper care, please follow these instructions carefully.

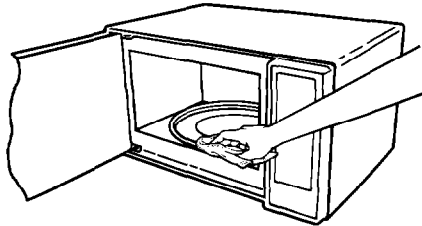

For interior surfaces: Wipe often with warm, sudsy water and a sponge or soft cloth. Use only mild, nonabrasive soaps or a mild detergent. Be sure to keep the areas clean where the door and oven frame touch when closed. Wipe well with clean water.

For exterior surfaces and control panel: Use a soft cloth with spray glass cleaner. Apply spray glass cleaner to soft cloth; do not spray directly on oven.

NOTE: Abrasive cleansers, steel-wool pads, gritty wash cloths, some paper towels, etc., can damage the control panel and the interior and exterior oven surfaces.

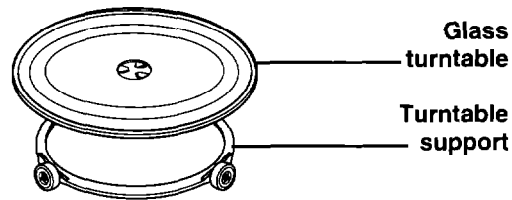

To clean turntable and turntable support, wash in mild, sudsy water; for heavily soiled areas use a mild cleanser and scouring sponge. The turntable and turntable support are dishwasher-safe.

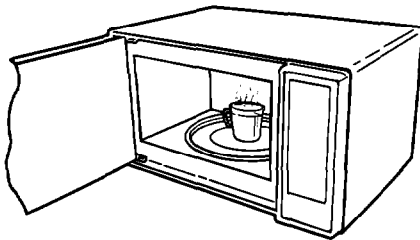

For stubborn soil, **boil** a cup of water in the oven for 2 or 3 minutes. Steam will soften the soil. To get rid of odors inside the oven, **boil** a cup of water with lemon juice or vinegar.

Cooking Guide

Reheating tips

- **Cooked food and leftovers** can be reheated quickly and efficiently without spoiling their freshness and taste.
- **Always place** the dense food at the outer edges and the more porous food towards the center.
- **To keep food moist** during reheating, cover the food with a microwave-safe lid or plastic wrap. Covering the food keeps heat in the food, speeds heating, and prevents spatters.
- **Wrap sandwiches and rolls** loosely in paper towels to absorb moisture and prevent sogginess.
- **Spread food** in a shallow dish if possible.
- **Stir and turn** food as needed.
- **Always underestimate** reheating time until you are used to the microwave oven.

Microwave cooking tips

Amount of food

- **The more food** you prepare, the longer it takes. A rule of thumb is that a double amount of food requires almost double the time. If one potato takes four minutes to cook, you need about seven minutes to cook two potatoes.

Starting temperature of food

- **The lower the temperature** of the food being put into the microwave oven, the longer it takes to cook. Food at room temperature will be reheated more quickly than food at refrigerator temperature.

Composition of food

- **Food with a lot of fat and sugar** will be heated faster than food containing a lot of water. Fat and sugar will also reach a higher temperature than water in the cooking process.
- **The more dense the food**, the longer it takes to heat. "Very dense" food like meat takes longer to reheat than lighter, more porous food like sponge cakes.

Size and shape

- **Smaller pieces of food** will cook faster than larger pieces and same-shaped pieces of food cook more evenly than irregularly shaped foods.
- **With unevenly shaped foods**, the thinner parts will cook faster than the thicker areas. **Place** the thinner parts of chicken wings and legs in the center of the dish.

Stirring, turning foods

- **Stirring and turning foods** distributes heat quickly to the center of the dish and avoids overcooking at the outer edges of the food.

Covering food

Cover food to:

- **Reduce** splattering
- **Shorten** cooking times
- **Retain** food moisture

All coverings that allow microwaves to pass through are suitable.

Releasing pressure in foods

- **Several foods** (for example: baked potatoes, sausages, egg yolks, and some fruits) are tightly covered by a skin or membrane. This can cause the food to burst from steam building up in them during cooking. To relieve the pressure and to prevent bursting, **prick** these foods before cooking with a fork, cocktail pick, or toothpick.

Using standing time

- **Always allow food to stand** for a while after cooking. Standing time after defrosting, cooking, or reheating always improves the result since the temperature will then be evenly distributed throughout the food.
- **The length of the standing time** depends on the volume and density of the food. Sometimes it can be as short as the time it takes you to remove the food from the oven and take it to the serving table. However, with larger, denser food, the standing time may be as long as 10 minutes.

Arranging food

For best results, distribute food evenly on the plate. You can do this in several ways:

- **If you are cooking several items of the same food**, such as baked potatoes, **place** them in a ring pattern for uniform cooking.
- **When cooking foods of uneven shapes or thickness**, **place** the smaller or thinner area of the food towards the center of the dish where it will be heated last.
- **Arrange uneven foods**, such as chicken breasts, with the thicker part to the outer edge.
- **If you are saving a meal in the refrigerator** or “plating” a meal for reheating, **arrange** the thicker, denser foods to the outside of the plate and the thinner or less dense foods in the middle.
- **Place thin slices of meat** on top of each other or interlace them.
- **Place thicker slices of meat**, such as meat loaf and sausages, close to each other.
- **Reheat gravy or sauce** in a separate container.
- **When you cook or reheat whole fish**, **score** the skin – this prevents cracking.
- **Shield the tail and head of whole fish** with small pieces of foil to prevent overcooking and ensure the foil does not touch the sides of the oven.
- **Do not** let food or container touch the top or sides of the oven. This will prevent possible arcing.

Using aluminum foil

Metal containers should not be used in a microwave oven. There are, however, some exceptions. If you have purchased food which is prepackaged in an aluminum foil container, then refer to the instructions on the package. When using aluminum foil containers, cooking times may be longer because microwaves will only penetrate the top of the food.

If you use aluminum containers without package instructions, follow these guidelines:

- **Place** container in a glass bowl and add some water so that it covers the bottom of the container, not more than ¼" high. This ensures even heating of the container bottom.
- **Always remove** the lid to avoid damage to the oven.
- **Use only** undamaged containers.
- **Do not use** containers taller than ¾".
- **Container must be** half filled.
- **To avoid arcing**, there must be a minimum ¼" between the aluminum container and the walls of the oven and also between two aluminum containers.
- **Always place** container on turntable.
- **Reheating food** in aluminum foil containers usually takes up to double the time compared to reheating in plastic, glass, china, or paper containers. The time when food is ready will vary a great deal.
- **Let food stand** for 2-3 minutes after heating so that heat is spread evenly throughout container.

Cooking you should not do in your microwave oven

- **Do not** do canning of foods in the oven. Closed glass jars may explode, resulting in damage to the oven or possible personal injury.
- **Do not** use the microwave oven to sterilize objects (baby bottles, etc.). It is difficult to maintain the high temperature required for safe sterilization.

Questions and Answers

QUESTIONS	ANSWERS
Can I operate my microwave oven without the turntable or turn the turntable over to accommodate a large dish?	No. If you remove or turn over the turntable, you will get poor cooking results. Dishes used in your oven must fit on the turntable.
Can I use a rack in my microwave oven so that I may reheat or cook on two levels at a time?	You can use a rack only if rack is supplied with your microwave oven. Use of any rack not supplied with the microwave oven can result in poor cooking performance and/or arcing.
Can I use either metal or aluminum pans in my microwave oven?	Useable metal includes aluminum foil for shielding (use small, flat pieces), small skewers, and shallow foil trays (if tray is $\frac{3}{4}$ inch deep and half filled with food to absorb microwave energy). Never allow metal to touch walls or door. (For more information, see page 30.)
Is it normal for the turntable to turn in either direction?	Yes. The turntable rotates clockwise or counterclockwise, depending on the rotation of the motor when the cooking cycle begins.
Sometimes the door of my microwave oven appears wavy. Is this normal?	This appearance is normal and does not affect the operation of your oven.
What are the humming noises that I hear when my microwave oven is operating?	You hear the sound of the transformer when the magnetron tube cycles on.
Why does the dish become hot when I microwave food in it? I thought that this should not happen.	As the food becomes hot it will conduct the heat to the dish. Be prepared to use hot pads to remove food after cooking.
What does "standing time" mean?	"Standing time" means that food should be removed from the oven and covered for additional time to allow it to finish cooking. This frees the oven for other cooking.
Can I pop popcorn in my microwave oven? How do I get the best results?	Yes. Pop packaged microwave popcorn following manufacturer's guidelines or use the preprogrammed Popcorn pad for 3.5 oz bags only. Do not use regular paper bags. Use the "listening test" by stopping the oven as soon as the popping slows to a "pop" every one or two seconds. Do not repop unpopped kernels. Do not pop popcorn in glass utensils. Do not unfold bag when popping 3.0 to 3.5 oz bags of popcorn, because in small size oven cavity, bag can become stuck between turntable and oven wall.
Why does steam come out of the air exhaust vent?	Steam is normally produced during cooking. The microwave oven has been designed to vent this steam out the rear vents.

Troubleshooting

Most cooking problems often are caused by little things you can find and fix without tools of any kind. Check the lists below and on the next page before calling for assistance or service. If you still need help, see "Requesting Assistance or Service" on page 34.

If nothing operates, check the following:

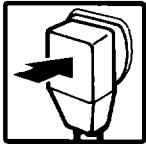

Is the microwave oven plugged into a live outlet with the proper voltage?
(See Installation Instructions.)



Have you blown a household fuse or tripped a circuit breaker?



Has the electric company experienced a power failure?

Other possible problems and their causes:

PROBLEM	CAUSE
The microwave oven will not run	<ul style="list-style-type: none"> • The door is not firmly closed and latched. • You did not touch START/ENTER. • You did not follow directions exactly. • An operation that was programmed earlier is still running. • You have not entered numbers after touching COOK TIME.
Microwave cooking times seem too long	<ul style="list-style-type: none"> • The electric supply to your home or wall outlets is low or lower than normal. Your electric company can tell you if the line voltage is low. Your electrician or service technician can tell you if the outlet voltage is low. • The cook power is not at the recommended setting. • Larger amounts of food need longer cooking times.

TROUBLESHOOTING

PROBLEM	CAUSE
The turntable will not turn	<ul style="list-style-type: none">• The turntable is not correctly in place. Make sure the turntable is correct-side up and is sitting securely on center shaft.• The support is not operating correctly. Remove turntable and restart oven. If turntable support does not move, call an authorized Whirlpool service technician for repair. Cooking without the turntable can give you poor results.
The Display shows a time counting down but the oven is not cooking	<ul style="list-style-type: none">• The oven door is not closed completely.• You have set the controls as a kitchen timer. Touch OFF/CANCEL to cancel the Minute Timer.
You do not hear the Programming Tone	<ul style="list-style-type: none">• The command is not correct.
The fan seems to be running slower than usual	<ul style="list-style-type: none">• The oven has been stored in a cold area. The fan will run slower until the oven warms up to normal room temperature.
The Display shows "88:88"	<ul style="list-style-type: none">• There has been a power interruption. Reset the clock.

If none of these items was causing your problem, see "Requesting Assistance or Service" on page 34.

Requesting Assistance or Service

Before calling for assistance or service, please check "Troubleshooting" on pages 32-33. It may save you the cost of a service call. If you still need help, follow the instructions below.

1. If you need assistance* ...

Call the Whirlpool Consumer Assistance Center telephone number.



Dial toll-free from anywhere in the U.S.A.:

1-800-253-1301

and talk with one of our trained consultants. The consultant can instruct you in how to obtain satisfactory operation from your appliance or, if service is necessary, recommend a qualified service company in your area.

If you prefer, write to:

Mr. William Clark
Consumer Assistance Representative
Whirlpool Corporation
2000 North M-63
Benton Harbor, MI 49022-2692

Please include a daytime phone number in your correspondence.

2. If you need service* ...

Whirlpool has a nationwide network of



authorized Whirlpool service companies. Whirlpool service technicians are trained to fulfill the product warranty and provide after-warranty service,

anywhere in the United States. To locate the authorized Whirlpool service company in your area, call our Consumer Assistance Center telephone number (see Step 1) or look in your telephone directory Yellow Pages under:

• APPLIANCE-HOUSEHOLD-MAJOR, SERVICE & REPAIR

- See: Whirlpool Appliances or Authorized Whirlpool Service
(Example: XYZ Service Co.)

• WASHING MACHINES & DRYERS, SERVICE & REPAIR

- See: Whirlpool Appliances or Authorized Whirlpool Service
(Example: XYZ Service Co.)

3. If you are not satisfied with how the problem was solved ...

- Contact the Major Appliance Consumer Action Program (MACAP). MACAP is a group of independent consumer experts that voices consumer views at the highest levels of the major appliance industry.
- Contact MACAP only when the dealer, authorized servicer, and Whirlpool have failed to resolve your problem.

Major Appliance Consumer Action Program
20 North Wacker Drive
Chicago, IL 60606

- MACAP will in turn inform us of your action.

*When asking for help or service:

Please provide a detailed description of the problem, your appliance's complete model and serial numbers, and the purchase date. (See page 3.) This information will help us respond properly to your request.

Index

This index is alphabetical. It contains all the topics included in this manual, along with the page(s) on which you can find each topic.

TOPIC	PAGE	TOPIC	PAGE
ALUMINUM FOIL	30	PARTS AND FEATURES	
AUDIBLE SIGNALS	15	Cooking guide label	13
CARING FOR YOUR MICROWAVE		Door open button	13
OVEN	27	Door safety lock system	13
CONTROL PANEL	14-15	Light	13
ADD MINUTE	17	Magnetron	11, 31
BAKED POTATOES	22	Model and serial number plate	13
CLOCK	16	Turntable	8, 12, 13, 27, 31
Cooking at different cook powers	19	Vents (exhaust & air intake openings)	9
Cooking at high cook power	18	Window	13
COOK POWER	20, 21	QUESTIONS AND ANSWERS	31
COOK TIME	18, 20, 21	RACK	31
DEFROST	25	RADIO INTERFERENCE	12
Display	14	REQUESTING ASSISTANCE	
Interrupting cooking	15	OR SERVICE	34
Multi-cycle cooking	21	SAFETY	4-8
Number pads	14	STANDING TIME	26, 29, 31
OFF/CANCEL	15	TIPS	
POPCORN/FROZEN ENTREE	23, 24	Cooking	29
START/ENTER	15	Defrosting	26
ERROR SIGNALS	15	Reheating	28
GROUNDING INSTRUCTIONS	10	TROUBLESHOOTING	32-33
HOW YOUR MICROWAVE		WARRANTY	36
OVEN WORKS	11-12	WATTAGE	18
INSTALLATION INSTRUCTIONS	9		

WHIRLPOOL®

Microwave Oven Warranty

LENGTH OF WARRANTY	WHIRLPOOL WILL PAY FOR
FULL ONE-YEAR WARRANTY From Date of Purchase	FSP® replacement parts and repair labor to correct defects in materials or workmanship. Service must be provided by an authorized Whirlpool service company.
LIMITED SEVEN-YEAR WARRANTY Second Through Eighth Year From Date of Purchase	FSP replacement magnetron tube on microwave ovens if defective in materials or workmanship.
WHIRLPOOL WILL NOT PAY FOR	
<p>A. Service calls to:</p> <ol style="list-style-type: none"> 1. Correct the installation of your microwave oven. 2. Instruct you how to use your microwave oven. 3. Replace house fuses or correct house wiring. 4. Replace owner-accessible light bulbs. <p>B. Repairs when your microwave oven is used in other than normal, single-family household use.</p> <p>C. In-home service. Your microwave oven must be taken to an authorized Whirlpool service company.</p> <p>D. Damage to your microwave oven caused by accident, misuse, fire, flood, acts of God, or use of products not approved by Whirlpool.</p> <p>E. Any labor costs during limited warranty.</p> <p>F. Repairs to parts or systems caused by unauthorized modifications made to the appliance.</p>	

2/95

WHIRLPOOL CORPORATION SHALL NOT BE LIABLE FOR INCIDENTAL OR CONSEQUENTIAL DAMAGES. Some states do not allow the exclusion or limitation of incidental or consequential damages, so this exclusion or limitation may not apply to you. This warranty gives you specific legal rights, and you may also have other rights which vary from state to state.

Outside the United States, a different warranty may apply. For details, please contact your authorized Whirlpool distributor or military exchange.

If you need service, first see the "Requesting Assistance or Service" section of this book. After checking "Requesting Assistance or Service," additional help can be found by calling our Consumer Assistance Center telephone number, **1-800-253-1301**, from anywhere in the U.S.A.