

# FRIGIDAIRE

All about the

# Use & Care

of your Built-In Range

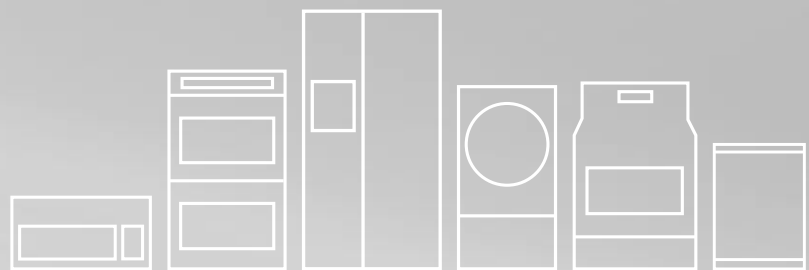

## TABLE OF CONTENTS

Welcome & Congratulations .....	2	Setting Oven Controls.....	14
Important Safety Instructions.....	3	Setting Keep Warm Drawer Control.....	30
Features at a Glance.....	7	Care & Cleaning (Cleaning Chart) .....	31
Before Setting Surface Burners.....	9	Care & Cleaning .....	32
Setting Surface Burners .....	10	Before You Call .....	35
Before Setting Oven Controls .....	11	Major Appliance Warranty .....	38

# WELCOME & CONGRATULATIONS

## Product Registration Register Your Product

The **PRODUCT REGISTRATION CARD** should be filled in completely, signed and returned to Electrolux Home Products.

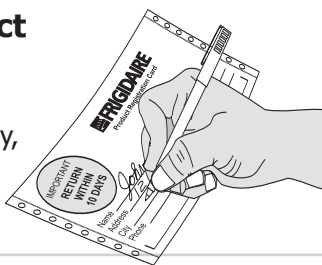

Congratulations on your purchase of a new appliance! At **Electrolux Home Products**, we are very proud of our product and are completely committed to providing you with the best service possible. Your satisfaction is our number one priority.

We know you'll enjoy your new appliance and **Thank You** for choosing our product. We hope you consider us for future purchases.

## PLEASE CAREFULLY READ AND SAVE THESE INSTRUCTIONS

This Use & Care Manual contains general operating instructions for your appliance and feature information for several models. Your product **may not** have all the described features. The graphics shown are representative. The graphics on your appliance may not look exactly like those shown. These instructions are not meant to cover every possible condition and situation that may occur. Common sense and caution must be practiced when installing, operating and maintaining any appliance.

## Serial Plate Location

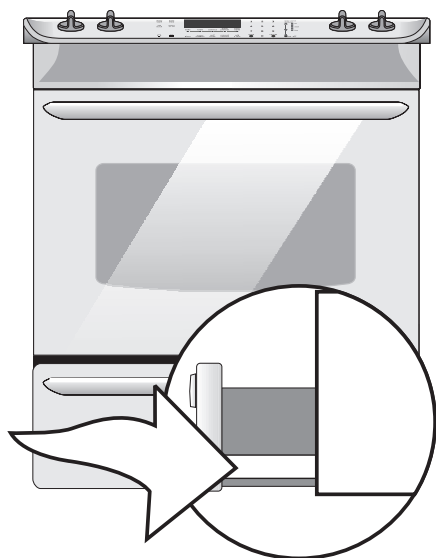

**Please record your model and serial numbers below for future reference.**

Model Number: \_\_\_\_\_

Serial Number: \_\_\_\_\_

Purchase Date: \_\_\_\_\_

## NOTE

Please attach sales receipt here for future reference.



# IMPORTANT SAFETY INSTRUCTIONS

Read all instructions before using this appliance.  
Save these instructions for future reference.

## WARNING

If the information in this manual is not followed exactly, a fire or explosion may result causing property damage, personal injury or death.

### FOR YOUR SAFETY

- Do not store or use gasoline or other flammable vapors and liquids in the vicinity of this or any other appliance.
- **WHAT TO DO IF YOU SMELL GAS:**
  - Do not try to light any appliance.
  - Do not touch any electrical switch; do not use any phone in your building.
  - Immediately call your gas supplier from a neighbor's phone. Follow the gas supplier's instructions.
  - If you cannot reach your gas supplier, call the fire department.
- Installation and service must be performed by a qualified installer, servicer or the gas supplier.

### DEFINITIONS

 This is the safety alert symbol. It is used to alert you to potential personal injury hazards. Obey all safety messages that follow this symbol to avoid possible injury or death.

## WARNING

This symbol will help alert you to situations that may cause serious bodily harm, death or property damage.

## CAUTION

This symbol will help alert you to situations that may cause bodily injury or property damage.

## IMPORTANT

IMPORTANT indicates installation, operation or maintenance information which is important but not hazard-related.

## WARNING



- All appliance can tip.
- Injury to persons could result.
- Install anti-tip bracket packed with your appliance.
- See Installation Instructions.



To reduce the risk of tipping, the appliance must be secured by properly installed anti-tip bracket provided with the unit. Refer to the Installation Instructions for proper anti-tip bracket installation.

- Remove all tape and packaging wrap before using the appliance. Destroy the carton and plastic bags after unpacking the appliance. Never allow children to play with packaging material. Do not remove the wiring label and other literature attached to the appliance. Do not remove model/serial number plate.
- Proper Installation. Be sure your appliance is properly installed and grounded by a qualified technician in accordance with the Canadian Standards CAN/CGA B149.1, and CAN/CGA B149.2, and Canadian Electrical Code, part 1, and local code requirements. Install only per installation instructions provided in the literature package for this range.  

Ask your dealer to recommend a qualified technician and an authorized repair service. Know how to disconnect the electrical power to the appliance at the circuit breaker or fuse box in case of an emergency.
- User Servicing. Do not repair or replace any part of the appliance unless specifically recommended in the manuals. All other servicing should be done only by a qualified technician to reduce the risk of personal injury and damage to the appliance.
- Never modify or alter the construction of an appliance by removing leveling legs, panels, wire covers, anti-tip brackets/screws, or any other part of the product.

## WARNING

Stepping, leaning, sitting or pulling down on the door or the drawer of this appliance can result in serious injuries and also cause damage to the appliance. Do not allow children to climb or play around the appliance. The weight of a child on an open door may cause the appliance to tip, resulting in serious burns or other injury.

## IMPORTANT SAFETY INSTRUCTIONS

### WARNING

Do not use the oven or warm & serve drawer (if equipped) for storage.

### CAUTION

Do not store items of interest to children in the cabinets above the appliance. Children climbing on the cooktop to reach items could be seriously injured.

### WARNING

NEVER use this appliance as a space heater to heat or warm the room. Doing so may result in carbon monoxide poisoning and overheating of the oven.

- **Storage in or on Appliance. Flammable materials should not be stored in an oven, near surface burners or in the warm & serve drawer (if equipped).** This includes paper, plastic and cloth items, such as cookbooks, plastic ware and towels, as well as flammable liquids. Do not store explosives, such as aerosol cans, on or near the appliance. Flammable materials may explode and result in fire or property damage.
- **Do not leave children alone. Children should not be left alone or unattended in the area where an appliance is in use.** They should never be allowed to sit or stand on any part of the appliance.
- **DO NOT TOUCH SURFACE BURNERS, AREAS NEAR THESE BURNERS, OVEN BURNERS OR INTERIOR SURFACES OF THE OVEN.** Both surface burners and oven burners may be hot even though flames are not visible. Areas near surface burners may become hot enough to cause burns. During and after use, do not touch, or let clothing or other flammable materials touch these areas until they have had sufficient time to cool. Among these areas are the cooktop, surfaces facing the cooktop, the oven vent openings and the surfaces near these openings, oven door and window.
- **Wear Proper Apparel. Loose-fitting or hanging garments should never be worn while using the appliance.** Do not let clothing or other flammable materials contact hot surfaces.
- **Do Not Use Water or Flour on Grease Fires. Smother the fire with a pan lid, or use baking soda, a dry chemical or foam-type extinguisher.**
- **When heating fat or grease, watch it closely.** Fat or grease may catch fire if allowed to become too hot.

### WARNING

In case of fire or gas leak, be sure to turn off the main gas shutoff valve.

- **Use Only Dry Pot holders. Moist or damp pot holders on hot surfaces may result in burns from steam.** Do not let the pot holders touch hot surface units. Do not use a towel or other bulky cloth instead of a pot holder.
- **Do Not Heat Unopened Food Containers. Buildup of pressure may cause the container to burst and result in injury.**
- **Remove the oven door from any unused appliance if it is to be stored or discarded.**

### IMPORTANT

Do not attempt to operate the appliance during a power failure. If the power fails, always turn off the unit. If the unit is not turned off and the power resumes, the appliance will not operate and an error message will be displayed. Once the power resumes, reset the clock and the oven function.

### CAUTION

Electronic controllers can be damaged by cold temperatures. When you use your appliance for the first time, or if it has not been used for a long period of time, make sure that it has been exposed to a temperature above 0°C/32°F for at least 3 hours before connecting it to the power supply.

## IMPORTANT INSTRUCTIONS FOR USING YOUR COOKTOP

### WARNING

**Use Proper Flame Size**—Adjust flame size so it does not extend beyond the edge of the utensil. The use of undersized utensils will expose a portion of the burner flame to direct contact and may result in ignition of clothing. Proper relationship of utensil to flame will also improve efficiency.

- **Use Proper Pan Size**—This appliance is equipped with one or more surface burners of different sizes. Select utensils having flat bottoms large enough to cover the surface burner. The use of undersized utensils will expose a portion of the burner flame to direct contact and may result in ignition of clothing. Proper relationship of utensil to flame will also improve efficiency.

## IMPORTANT SAFETY INSTRUCTIONS

- **Know which knob controls each surface burner.** Place pan of food on the burner before turning it on, and turn the burner off before removing the pan.
- **Do not use Searing Grill on the cooktop**—The Searing grill is not designed for use on the cooktop. Doing so may result in a fire.

### **WARNING**

**Do not use stove top grills on your sealed gas burners. If you use a stove top grill on a sealed gas burner, it will cause incomplete combustion and can result in exposure to carbon monoxide levels above allowable current standards. This can be hazardous to your health.**

- **Always turn the knob to the full LITE position when igniting top burners.** Visually check that the burner has lit. Then adjust the flame so it does not extend beyond the edge of the utensil.
- **Utensil Handles Should Be Turned Inward and Not Extend Over Adjacent Surface Burners**—To reduce the risk of burns, ignition of flammable materials, and spillage due to unintentional contact with the utensil, the handle of the utensil should be positioned so that it is turned inward, and does not extend over adjacent surface burners.
- **Never Leave Surface Burners Unattended at High Heat Settings**—Boilovers cause smoking and greasy spillovers that may ignite, or a pan that has boiled dry may melt.
- **Protective Liners**—Do not use aluminum foil to line surface burner pans. Protective liners or aluminum foil may interfere with heat and air distribution, and combustion. Damage to the cooktop or personal injury may result.
- **Glazed Cooking Utensils**—Only certain types of glass, glass/ceramic, ceramic, earthenware, or other glazed utensils are suitable for cooktop service without breaking due to the sudden change in temperature. Check the manufacturer's recommendations for cooktop use.
- **Do Not Use Decorative Surface Burner Covers.** If a burner is accidentally turned on, the decorative cover will become hot and possibly melt. You will not be able to see that the burner is on. Burns will occur if the hot covers are touched. Damage may also be done to the cooktop or burners because the covers may cause overheating. Air will be blocked from the burner and cause combustion problems.

## IMPORTANT SAFETY INSTRUCTIONS FOR USING YOUR OVEN

- **Use Care When Opening Oven Door or Warm & Serve Drawer (if equipped)**—Stand to the side of the appliance when opening the door/drawer of a hot appliance. Let hot air or steam escape before you remove or replace food in the oven/drawer.
- **Keep Oven Vent Ducts Unobstructed.** The oven is vented at the center of the cooktop. Touching the surfaces in this area when the oven is operating may cause severe burns. Also, do not place plastic or heat-sensitive items on or near the oven vent. These items could melt or ignite.

### **WARNING**

**NEVER cover any slots, holes or passages in the oven bottom or cover an entire rack with materials such as aluminum foil.** Doing so blocks air flow through the oven and may cause carbon monoxide poisoning. Aluminum foil linings may trap heat, causing a fire hazard.

- **Placement of Oven/Warm & Serve Drawer (if equipped) Racks.** Always place oven/Warm & Serve Drawer (if equipped) racks in desired location while appliance is cool. Remove all utensils from the rack before removing rack. If rack must be moved while oven is hot, use extreme caution. Use pot holders and grasp the rack with both hands to reposition. Do not let pot holders contact the hot oven burner or interior of the oven.
- **Do not use a broiler pan without its insert.** Broiler pan and grid allow dripping fat to drain and be kept away from the high heat of the broiler.
- **Do not cover the broiler grid or oven bottom with aluminum foil.** Exposed fat and grease could ignite.
- **Do not touch a hot oven light bulb with a damp cloth.** Doing so could cause the bulb to break. Disconnect the appliance or shut off the power to the appliance before removing and replacing the bulb.

## IMPORTANT SAFETY INSTRUCTIONS FOR CLEANING YOUR OVEN

- **Clean the appliance regularly to keep all parts free of grease that could catch fire.** Exhaust fan ventilation hoods and grease filters should be kept clean. Do not allow grease to accumulate. Greasy deposits in the fan could catch fire. Refer to the hood manufacturer's instructions for cleaning.

## IMPORTANT SAFETY INSTRUCTIONS

- **Cleaners/Aerosols**—Always follow the manufacturer's recommended directions for use. Be aware that excess residue from cleaners and aerosols may ignite causing damage and/or injury.
- **Clean in the self-cleaning cycle only the parts of the appliance listed in this Owner's Guide.** Before using the self-cleaning cycle of the appliance, remove all utensils stored in the appliance.
- **Do not clean the oven door gasket.** The door gasket is essential for a good seal. Care should be taken not to rub, damage or move the gasket.
- **Do not use oven cleaners.** No oven cleaner or oven liner protective coating of any kind should be used in or around any part of the appliance.
- **Remove oven racks.** Oven racks color will change if left in the oven during a self-cleaning cycle.

### CAUTION

The health of some birds is extremely sensitive to the fumes given off during the self-clean cycle of any wall oven. Move birds to another well ventilated room.

## CONVERSION TO LIQUEFIED PETROLEUM GAS (OR L.P. GAS)

This natural gas range is designed to allow for conversion to Liquefied Petroleum (L.P.) Gas.

If L.P. conversion is needed, contact the service center for assistance. The L.P. Conversion Kit is provided with this cooktop and is located in the literature envelope. Before installing the kit be sure to follow the L.P. Installation Instructions carefully.

### WARNING

Personal injury or death from electrical shock may occur if the range is not installed by a qualified installer or electrician.

### CAUTION

Any additions, changes or conversions required in order for this appliance to satisfactorily meet the application needs must be made by an authorized Service Center.

## SAVE THESE INSTRUCTIONS

## FEATURES AT A GLANCE - MODEL A

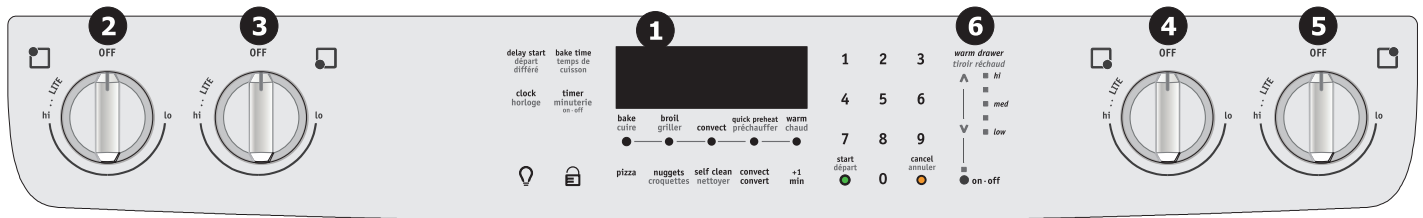

### Your built-in range Features:

1. Electronic oven control with kitchen timer.
2. Left rear burner control.
3. Left front burner control.
4. Right front burner control.
5. Right rear burner control.
6. Warm & serve drawer control.
7. Automatic oven door light switch.
8. Self-clean door latch.
9. Oven vent.
10. Broil element.
11. 1 or 2 Oven interior light with removable cover.
12. Self-cleaning oven interior.
13. Convection bake cooking system fan.
14. Adjustable interior oven rack(s).
15. Large 1-piece oven door handle.
16. Full width oven door with window.
17. Warm & serve drawer.
18. 15000 BTU surface burner.
19. 5000 BTU surface burner.
20. 9500 BTU surface burner.
21. 17000 BTU surface burner.
22. Cast iron side grate.
23. Cast iron center grate.
24. Easy to clean porcelain cooktop.

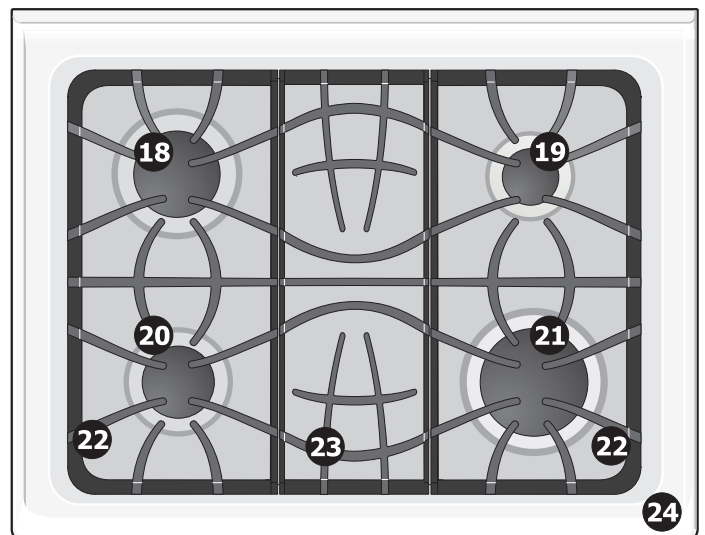
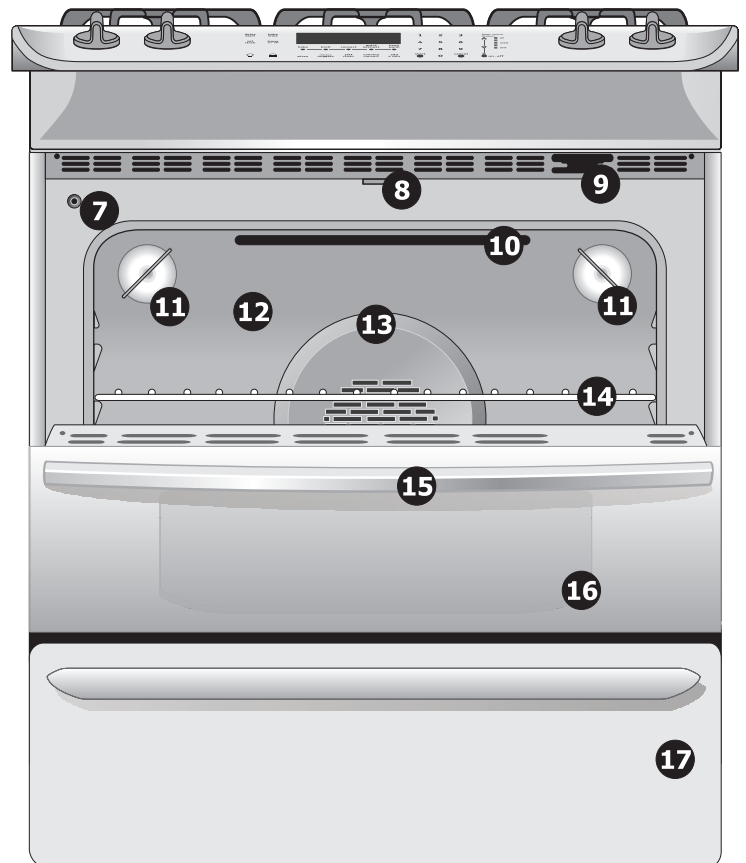

### NOTE

The features shown for your appliance may vary according to model type & color.



## FEATURES AT A GLANCE - MODEL B

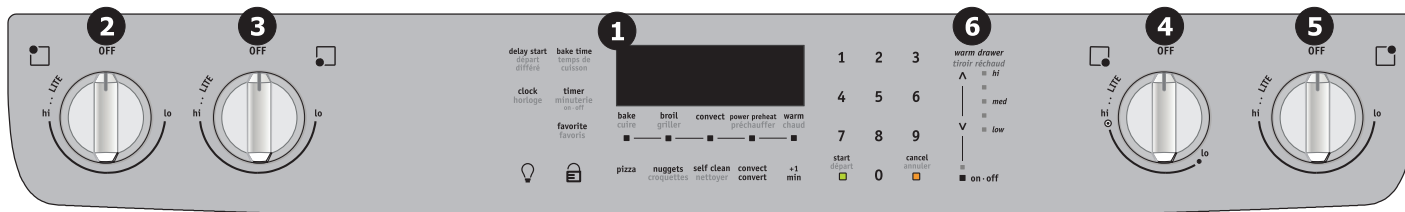

### Your built-in range Features:

1. Electronic oven control with kitchen timer.
2. Left rear burner control.
3. Left front burner control.
4. Right front dual burner control.
5. Right rear burner control.
6. Warm & serve drawer control.
7. Automatic oven door light switch.
8. Self-clean door latch.
9. Oven vent.
10. 2 Oven interior light with removable cover.
11. Self-cleaning oven interior.
12. Broil element.
13. Convection bake cooking system fan.
14. Adjustable interior oven rack(s).
15. Large 3-piece oven door handle.
16. Stainless steel oven door with window.
17. Warm & serve drawer.
18. 15000 BTU surface burner.
19. 5000 BTU surface burner.
20. 9500 BTU surface burner.
21. 17000 BTU Dual surface burner.
22. Cast iron side grate.
23. Cast iron center grate.
24. Easy to clean porcelain cooktop.

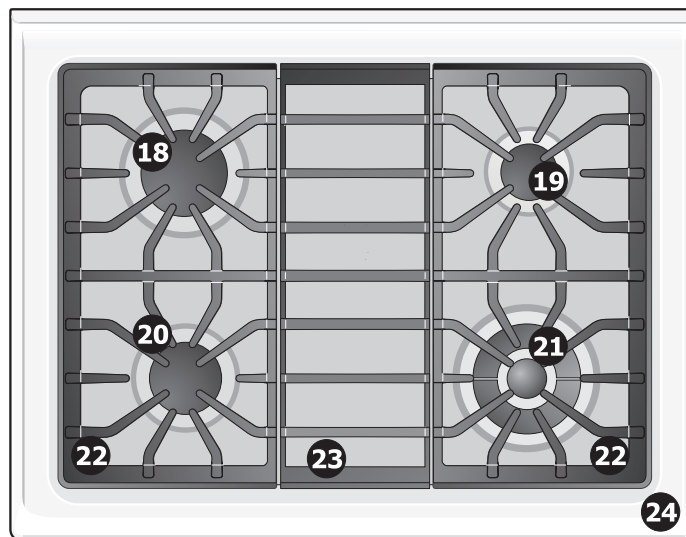
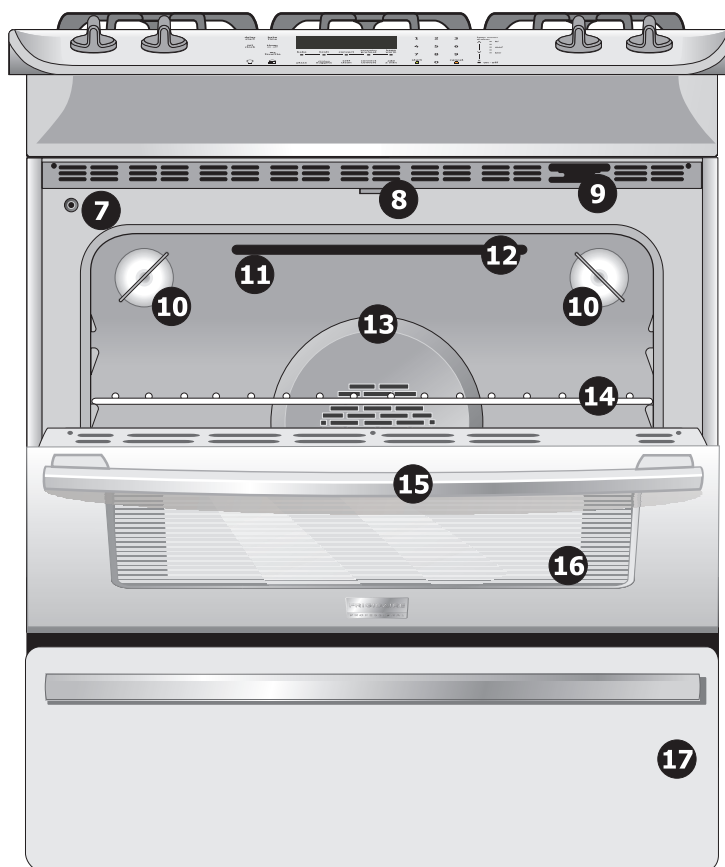

### NOTE

The features shown for your appliance may vary according to model type & color.



## BEFORE SETTING SURFACE BURNERS

### Control locations of the gas surface burners

Your built-in range is equipped with gas surface burners with different BTU ratings. The ability to heat food quicker and in larger volumes increases as the burner size increases.

The small SIMMER burner is best used for simmering delicate sauces, etc. This burner is located at the right rear burner position on the cooktop (see Figures 1 & 2).

The STANDARD burner can be used for most surface cooking needs. The standard burner is located at the left front position on the cooktop (see Figures 1 & 2).

The POWER burners are best used for bringing large quantities of liquid rapidly up to temperature or when preparing larger quantities of food. The POWER burners are located at the right front and left rear burner positions on the cooktop (see Figures 1 & 2).

Regardless of size, always select cookware that is suitable for the amount and type of food being prepared. Select a burner and flame size appropriate to the pan. Never allow flames to extend beyond the outer edge of the pan.

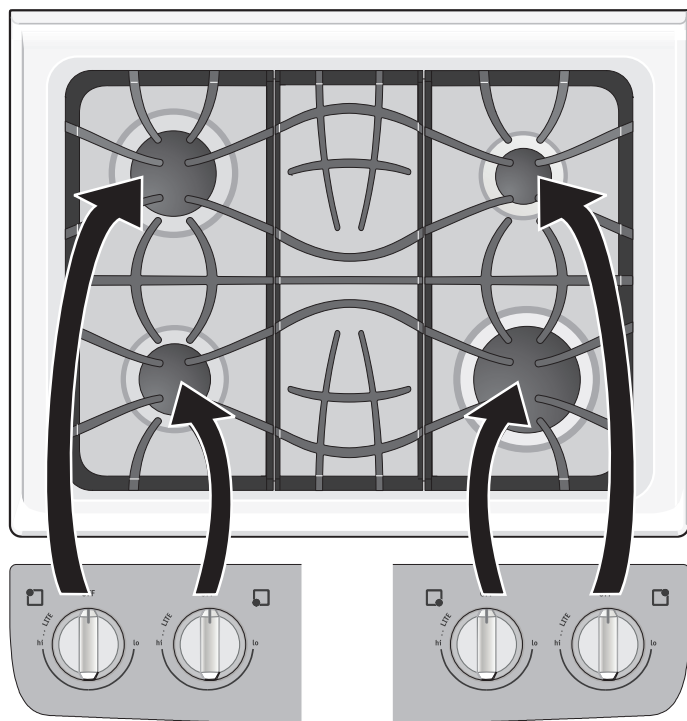

Figure 1 - Model A

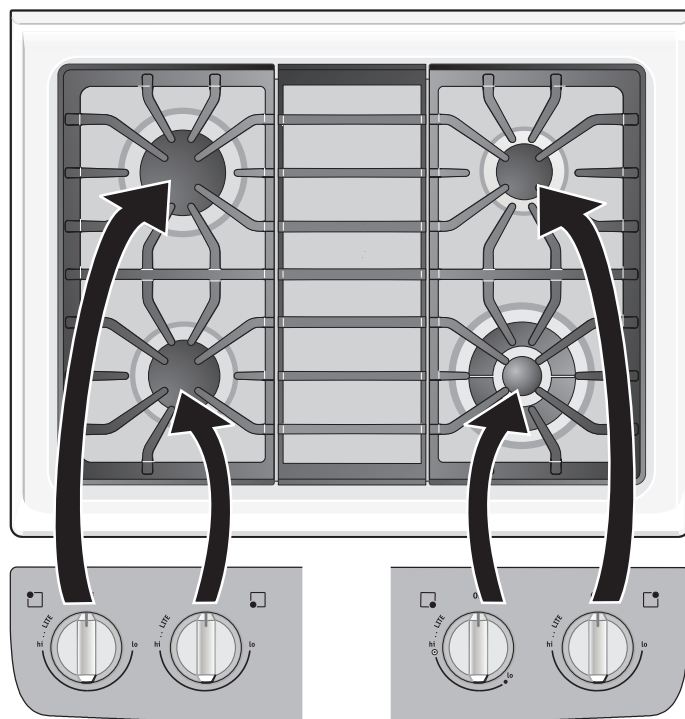

Figure 2 - Model B

### Assembly of the surface burner caps and burner grates

It is very important to make sure that all of the Surface Burner Caps and Surface Burner Grates are installed correctly and at the correct locations.

1. Remove all packing material from cooktop area.
2. Discard all packing material (if applicable).
3. Unpack Burner Grates and position on the cooktop.

**REMEMBER — DO NOT ALLOW SPILLS, FOOD, CLEANING AGENTS OR ANY OTHER MATERIAL TO ENTER THE GAS ORIFICE HOLDER OPENING.**

Always keep the Burner Caps and Burner Heads in place whenever the surface burners are in use.

## SETTING SURFACE BURNERS

### Operating the gas surface controls

1. Place cooking utensil on surface burner.
2. Push the surface control knob down and turn **counterclockwise** out of the OFF position.
3. Release the knob and rotate to the LITE position (see figures 1 & 2). Note: All four electronic surface igniters will spark at the same time. However, only the burner you are turning on will ignite.
4. Visually check that the burner has a flame.
5. Turn the control knob **counterclockwise** to the desired flame size. The control knobs do not have to be set at a particular setting. Use the knob indicator settings to adjust the flame as needed. **DO NOT** cook with the surface control knob in the LITE position. (The electronic ignitor will continue to spark if the knob is left in the LITE position.)

### CAUTION

**Do not place plastic items such as salt and pepper shakers, spoon holders or plastic wrappings on top of the range when it is in use.** These items could melt or ignite. Pot holders, towels or wood spoons could catch fire if placed too close to a flame.

### CAUTION

**Do not operate the burner for an extended period of time without cookware on the grate.** The finish on the grate may chip without cookware to absorb the heat.

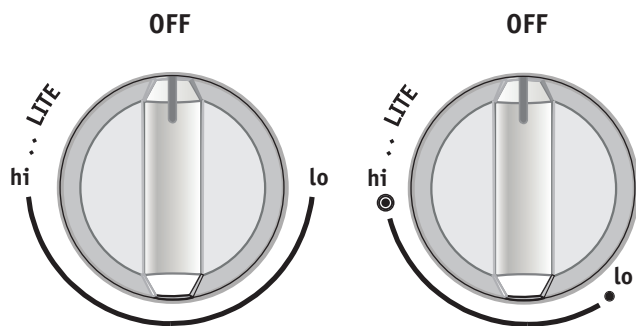

**Figure 1**  
(All models)

**Figure 2**  
(Model B only)

### IMPORTANT

In the event of an electrical power outage, the surface burners can be lit manually. To light a surface burner, hold a lit match to the burner head, then slowly turn the surface control knob to LITE. After burner lights turn the knob to desired setting. Use caution when lighting surface burners manually.

### Setting proper surface burner flame size

**For most cooking** - start on the highest control setting and then turn to a lower one to complete the process. Use the recommendations below as a guide for determining proper flame size for various types of cooking. The size and type of utensil used and the amount of food being cooked will influence the setting needed.

**For deep fat frying** - use a thermometer and adjust the surface control knob accordingly. If the fat is too cool, the food will absorb the fat and be greasy. If the fat is too hot, the food will brown so quickly that the center will be undercooked. Do not attempt to deep fat fry too much food at once as the food will neither brown nor cook properly.

*Flame Size	Type of Cooking
High Flame (Hi)	Start most foods; bring water to a boil; pan broiling.
Medium Flame (Med)	Maintain a slow boil; thicken sauces, gravies; steaming.
Low Flame (Lo)	Keep foods cooking; poach; stewing.

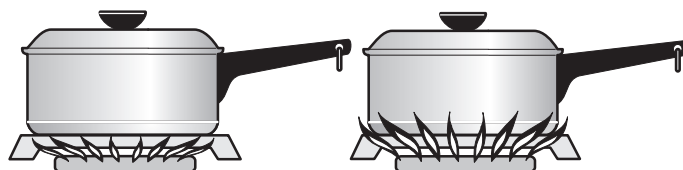

**Correct**

**Incorrect**

### IMPORTANT

Never extend the flame beyond the outer edge of the utensil. A higher flame simply wastes heat and energy, and increases the risk of being burned by the gas flame.

### NOTE

**\*Note: Settings are based on using medium-weight metal or aluminum pans. Settings may vary when using other types of pans.** The color of the flame is the key to proper burner adjustment. A good flame is clear, blue and hardly visible in a well-lit room. Each cone of flame should be steady and sharp. Clean burner if flame is yellow-orange.

## BEFORE SETTING OVEN CONTROLS

### Oven vent location

The oven is vented **at the center rear of the cooktop**. When the oven is on, warm air is released through the vent. This venting is necessary for proper air circulation in the oven and good baking results. **DO NOT BLOCK OVEN VENT**. Never close off the openings with aluminium foil or any other material.

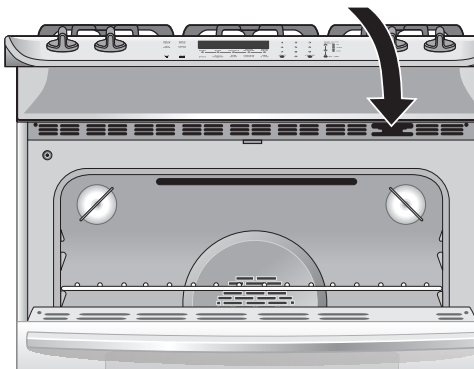

(Model B shown only)

### CAUTION

Some models are equipped with a blower which runs in baking and self-cleaning mode to keep all internal components at a cool temperature. The blower may keep running even if the oven has been turned off, until the components have cooled down.

### Air circulation in the oven

If using 1 rack, place in center of oven. If using multiple racks, stagger cookware as shown.

For best air circulation and baking results allow 2-4" (5,1 -10,2 cm) around the cookware for proper air circulation and be sure pans and cookware do not touch each other, the oven door, sides or back of the oven cavity. The hot air must circulate around the pans and cookware in the oven for even heat to reach around the food.

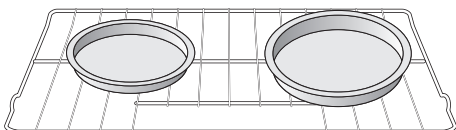

Single Oven Rack

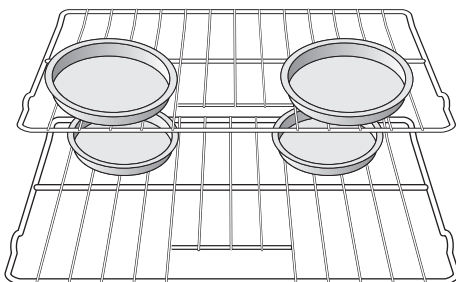

Multiple Oven Racks

### Arranging oven racks

ALWAYS ARRANGE OVEN RACKS WHEN THE OVEN IS COOL (PRIOR TO OPERATING THE OVEN). Always use oven mitts when using the oven.

**To remove an oven rack**, pull the rack forward until it stops. Lift up front of rack and slide out.

**To replace an oven rack**, fit the rack onto the guides on the oven walls. Tilt the front of the rack upward and slide the rack back into place.

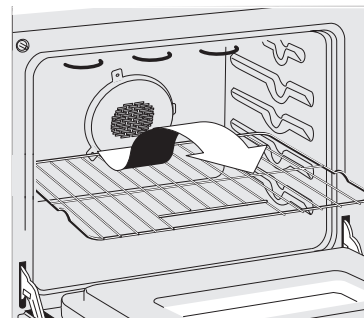

### Recommended rack positions

Food	Rack Position
Broiling meats, chicken or fish	2 or 4
Cookies, cakes, pies, biscuits & muffins	
Using a single rack	2 or 3
Using 2 racks	2 and 4
Using 3 racks	2, 3 and 4
Frozen pies, angel food cake, yeast, bread, 1 or 2 casseroles, small cuts of meat or poultry	1 or 2
Turkey, roast or ham	1

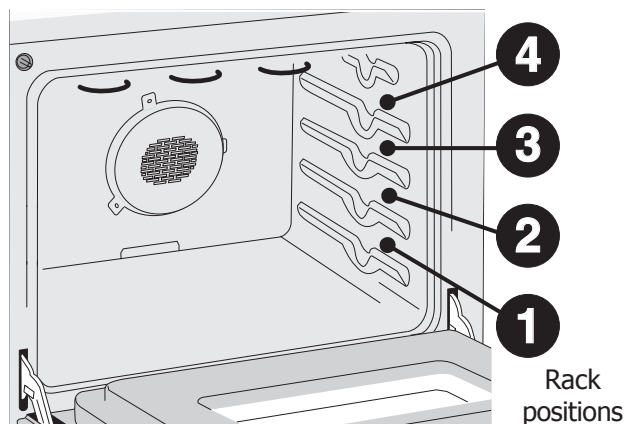

Rack positions

### NOTE

Always use caution when removing food from the oven.

# BEFORE SETTING OVEN CONTROLS

## Types of oven racks

Your built-in range may be equipped with one or more of the oven racks styles shown;

- **Flat handle oven rack** (Figure 1).
- **Flat oven half rack** (Figure 2 & 3 - Some models).
- **Effortless™ oven rack** (Figure 4 - Some models).

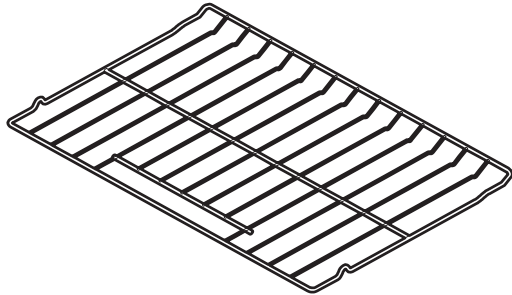

**Figure 1**  
Flat handle oven rack

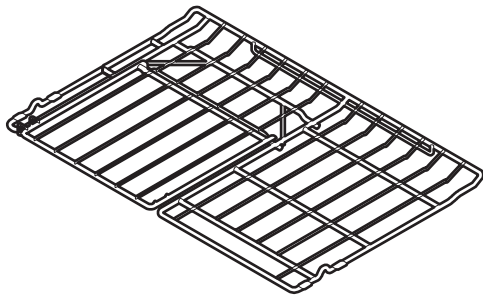

**Figure 2**  
Flat half oven rack - Closed position

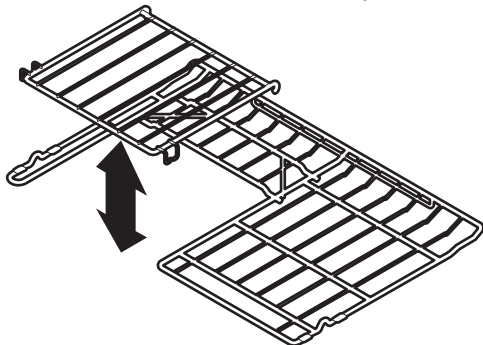

**Figure 3**  
Flat half oven rack - Open position

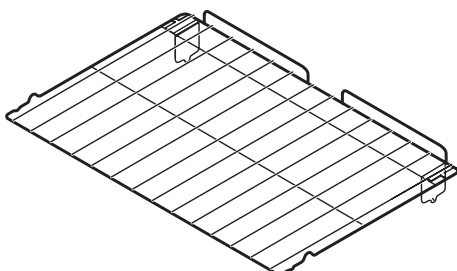

**Figure 4**  
Effortless™ oven rack

## CAUTION

Always use pot holders or oven mitts when adjusting the oven racks. Wait until the oven has completely cooled if possible. Oven racks may be HOT and may cause burns.

The **Flat Oven Handle Rack** has an handle to facilitate the sliding of the rack when large amount of foods weight on it.

The **Flat Oven Half Rack** has a removable insert that can provide extra space for larger food items. The right half rack portion may still be used for other food items like a casserole dish (See Figure 2 & 3). To remove the insert, squeeze on the left front insert side (See Figure 5) of the rack and tilt out clockwise. To reinstall, insert rear hooks at back of insert (See figure 5) and lay insert down. Make sure both insert front hooks snap into rack (See figure 6).

**Do not use** cookware that extends beyond the edge of the Flat Half Rack. For best results, allow 2 inches between the pan placed on the rack and oven side or rear walls.



**Figure 5**

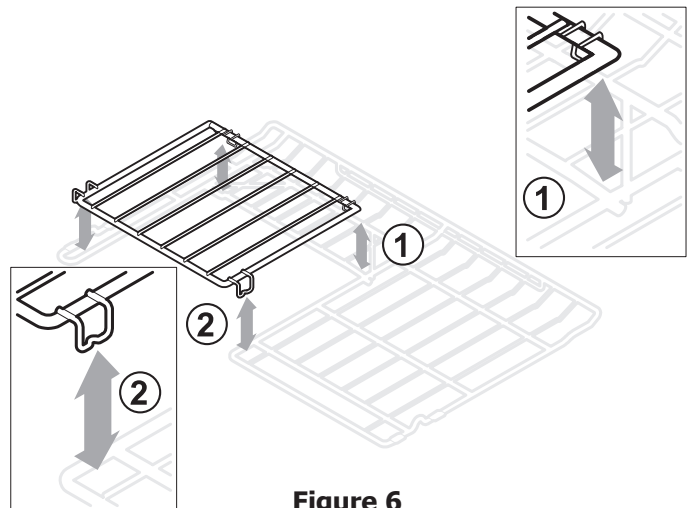

**Figure 6**

## BEFORE SETTING OVEN CONTROLS

### The Effortless™ oven rack system

Some models are equipped with a special oven rack system that automatically partially extends the oven rack from the interior oven glides to assist in easier access to your food items. This feature works whenever the oven door is opened or closed.

#### To assemble the Effortless™ Oven Rack system:

1. Locate all required parts. You will need the supplied oven rack (Effortless™ Oven Rack is a flat rack with a special dark coating on the left and right rack sides) and the 2 supplied chrome connector arms.
2. Open the oven door. Be sure the oven is completely cool before proceeding.
3. Place the oven rack in positions 1, 2 or 3 only (see previous page to verify positions). Be sure the rack connector brackets are at the rear of the range and pointing towards oven bottom (See Figure 2).
4. Assemble one connector arm at a time. With the oven door open and the oven rack in place, install one end of the connector arm to the hole in the door connector bracket (Figure 1) and the other end in the hole in the rack connector bracket (Figure 2 and as in Figure 3). The oven rack may need to be adjusted in or out in the rack position to match the length of the connector arm.
5. While holding the connector arm in place, twist the connector arm so the ends of the connector arm point upwards (See Figures 4 & 5). The connector arm should now be locked into position.
6. Repeat steps 4 and 5 for the other connector arm.
7. Once both connector arms are properly in place, be sure to test the oven rack operation by gently closing the oven door. The oven rack should move in and out of the oven freely when the door is opened or closed.

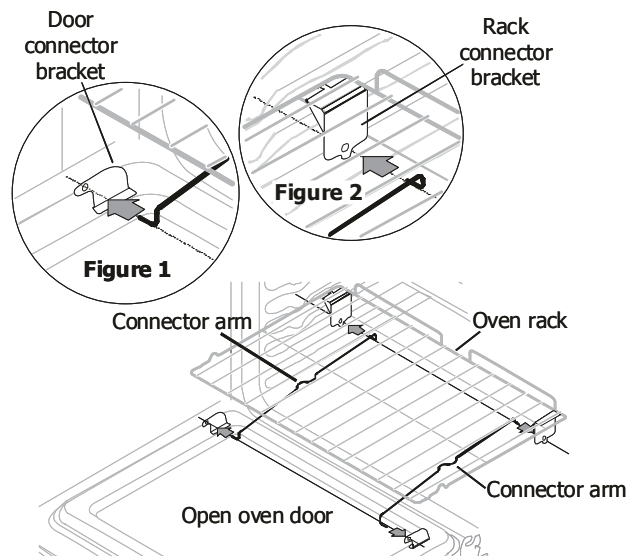

Figure 3 - Assembly of the Effortless™ oven rack

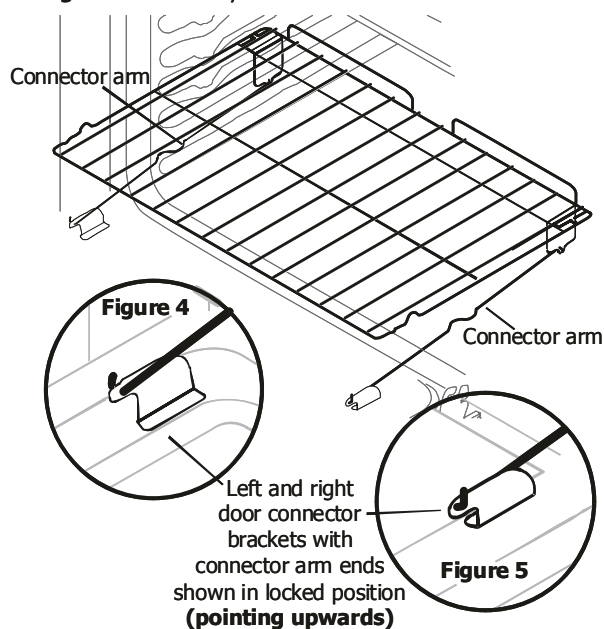

Figure 6 - Effortless™ oven rack after assembly

### CAUTION

**REMOVE ALL OVEN RACKS and parts before starting a self-clean cycle.** If the oven racks are left in the oven during the self-clean cycle, the glide ability of the Effortless Oven Rack system will be damaged and will cause all oven racks to lose their shiny finish and or turn blue. Remove **ALL** oven racks and clean according to instructions provided in the Care & Cleaning section of this manual.

Make sure the oven and oven racks are COMPLETELY cooled and safe to touch before attempting to assemble or disassemble the Effortless™ Oven Rack system.

**Never pick up hot oven rack parts.**



# SETTING OVEN CONTROLS

## Control pad features

**READ THE INSTRUCTIONS CAREFULLY BEFORE USING THE OVEN.** For satisfactory use of your oven, become familiar with the various features and functions of the oven as described below. **Detailed instructions for each feature and function follow later in this Use & Care Guide.**

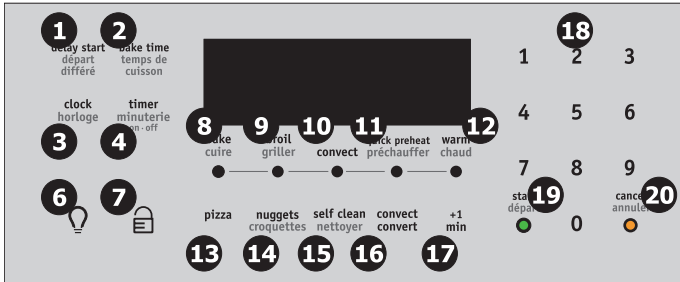

Figure 1 - Model A

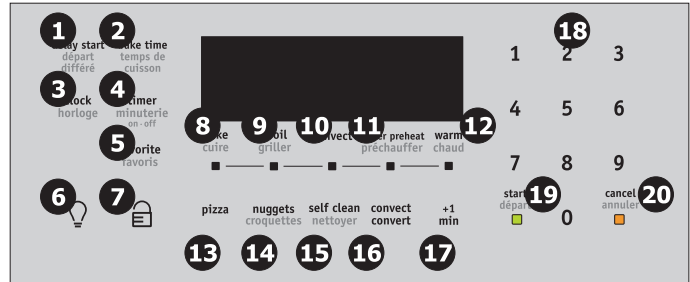

Figure 2 - Model B

- 1. Delay start pad**—Use to program a Delayed Timed Bake or Delay Self-Cleaning cycle start time.
- 2. Bake time pad**—Use to enter the length of the baking time.
- 3. Clock pad**—Use to set the time of day.
- 4. Timer on-off pad**—Use to set or cancel the Timer. The Timer does not start or stop cooking.
- 5. Favorite pad (some models)**—Use to record a temperature setting for a cooking feature.
- 6. Oven light pad**—Use to turn the oven light ON and OFF.
- 7. Oven lockout pad**—Use to lock the oven door and the control panel pads.
- 8. Bake pad**—Use to select the bake cooking feature.
- 9. Broil pad**—Use to select the broil cooking feature.
- 10. Convection pad**—Use to select between the Convection Bake, Convection Roast and Convection Broil (model B only) cooking features.
- 11. Quick preheat or power preheat pad**—Use to quickly raise oven to cooking temperature.

- 12. Warm pad**—Use to keep the dishes and food warm until served.
- 13. Pizza pad (some models)**—Use to select the pizza cooking feature.
- 14. Nuggets pad**—Use to select the chicken nuggets cooking feature.
- 15. Self-Clean pad**—Use to select the self cleaning feature.
- 16. Convection convert pad**—Use to convert a regular recipe temperature to a convection temperature.
- 17. +1 min pad**—Use to add a minute to the timer feature.
- 18. Numeric pad**—Use to enter temperatures and times.
- 19. Start pad**—Use to start all oven features (not used with Oven Light).
- 20. Cancel pad**—Use to cancel any oven feature previously entered except the time of day and minute timer.

## IMPORTANT THINGS TO KNOW BEFORE SETTING ANY OVEN COOKING FEATURE

This appliance has been factory pre-set to start any **BAKE, CONVECTION BAKE, CONVECTION ROAST** or **PREHEAT** feature with the oven set temperature automatically set for 350°F. The **BROIL** or **CONVECTION BROIL** features are pre-set at 550°F. However if desired, the oven set temperature may be adjusted at any time during the cooking process. You may also choose to add a **BAKE TIME** or **DELAY START** with most of the functions listed above, unless specified in their corresponding section.

## TEMPERATURE VISUAL DISPLAY

Your oven is equipped with a temperature visual display. When a cooking mode is set, the actual temperature will be shown in the display and will rise as the unit preheat. When the unit has reached its target temperature, a chime will sound to remind you to place the food in the oven. This feature will be active with some cooking modes; **BAKE, CONVECTION BAKE, CONVECTION ROAST** and **PIZZA**.

### NOTE

The lowest temperature that can be displayed is 100°F.

# SETTING OVEN CONTROLS

## MINIMUM AND MAXIMUM CONTROL PAD SETTINGS

All of the features listed below have minimum and maximum time or temperature settings that may be entered into the control. An ENTRY acceptance beep will sound each time a control pad is touched (the acceptance beep on the Oven Lockout pad is delayed 3 seconds).

An ENTRY ERROR tone (3 short beeps) will sound if the entry of the temperature or time is below the minimum or above the maximum settings for the feature.

FEATURE		MINIMUM TEMP. /TIME	MAXIMUM TEMP. /TIME
PREHEAT		170°F/77°C	550°F/288°C
BAKE		170°F/77°C	550°F/288°C
BROIL		400°F/205°C	550°F/288°C
CONVECTION BAKE		170°F/77°C	550°F/288°C
CONVECTION ROAST		170°F/77°C	550°F/288°C
CONVECTION BROIL		400°F/205°C	550°F/288°C
PIZZA		170°F/77°C	550°F/288°C
NUGGETS		170°F/77°C	550°F/288°C
TIMER	12 Hr. Mode	0:01 Min.	11:59 Hr./Min.
	24 Hr. Mode	0:01 Min.	11:59 Hr./Min.
CLOCK TIME	12 Hr. Mode	1:00 Hr./Min.	12:59 Hr./Min.
	24 Hr. Mode	0:00 Hr./Min.	23:59 Hr./Min.
DELAY START	12 Hr. Mode	1:00 Hr./Min.	12:59 Hr./Min.
	24 Hr. Mode	0:00 Hr./Min.	23:59 Hr./Min.
BAKE TIME	12 Hr. Mode	0:01 Min.	5:59 Hr./Min.
	24 Hr. Mode	0:01 Min.	5:59 Hr./Min.
SELF CLEAN TIME		2 hours	4 hours

## SETTING THE CLOCK

The **CLOCK** pad is used to set the clock. The clock may be set for 12 or 24 hour time of day operation. The clock has been preset at the factory for the 12 hour operation. When the range is first plugged in, or when the power supply to the range has been interrupted, the timer in the display will flash.

**To set the clock** (example below for 1:30)

1. Press **CLOCK**. "CLO" will appear in the display.
2. Press **1 3 0** pads to set the time of day to 1:30. "CLO" will stay in the display.
3. Press **START**. "CLO" will disappear and the clock will start.

## CHANGING BETWEEN 12 OR 24 HOUR TIME OF DAY DISPLAY

1. Press and hold **CLOCK** for 6 seconds. "CLO" will appear in the display.
2. **CONTINUE** holding the pad until "12Hr dAY" or "24Hr dAY" appears in the display and the control beeps once.
3. Press **SELF CLEAN** to switch between the 12 and 24 hour time of day display. The display will show either "12Hr dAY" or "24Hr dAY".
4. Press **START** to accept the change or press **CANCEL** to reject the change.
5. Reset the correct time as described in **To set the Clock** above. Please note that if the 24 hour time of day mode was chosen, the clock will now display time from 0:00 through 23:59 hours.



## SETTING OVEN CONTROLS

### SETTING CONTINUOUS BAKE OR 6 HOUR ENERGY SAVING

The **TIMER** and **SELF CLEAN** pads control the Continuous Bake or 6 Hour Energy Saving features. The oven control has a factory preset built-in 6 Hour Energy Saving feature that will shut off the oven if the oven control is left on for more than 6 hours. The oven can be programmed to override this feature for Continuous Baking.

#### To set the control for Continuous Bake or 6 Hour Energy Saving features

1. Press and hold **TIMER** for 6 seconds. After 6 seconds "**6Hr OFF**" or "**StAY On**" will appear in the display and the control will beep once.
2. Press **SELF CLEAN** to switch between the 6 Hour Energy Saving and continuous bake features.

Note: "**6Hr OFF**" in the display indicates the control is set for the 6 Hour Energy Saving mode and "**StAY On**" indicates the control is set for the Continuous Bake feature.

3. Press **START** to accept the change (display will return to time of day) or press **CANCEL** to reject the change.

### SETTING TEMPERATURE DISPLAY — FAHRENHEIT OR CELSIUS:

The **BROIL** and **SELF CLEAN** pads control the Fahrenheit or Celsius temperature display modes. The oven control can be programmed to display temperatures in Fahrenheit or Celsius. The oven has been preset at the factory to display in Fahrenheit.

#### To change display from Fahrenheit to Celsius or Celsius to Fahrenheit

1. To tell if the display is set for Fahrenheit or Celsius press **BROIL** and hold it for 6 seconds; "**550°**" will appear and "**BROIL**" will flash in the display and a beep will sound. If "**FAhrnht**" appears, the display is set to show temperatures in Fahrenheit. If "**CELSIUS**" appears, the display is set to show temperatures in Celsius.
2. Press **SELF CLEAN** to switch between Fahrenheit or Celsius display modes. The display will show either "**FAhrnht**" or "**CELSIUS**".
3. Press **START** to accept the change or press **CANCEL** to reject the change.

### SETTING SILENT CONTROL OPERATION

The **DELAY START** and **SELF CLEAN** pads control the Silent Control operation feature. The Silent Control operation feature allows the oven control to be operated without sounds or beeps whenever necessary. If desired the control can be programmed for silent operation and later returned to operating with all the normal sounds and beeps.

#### To change control from normal sound operation to silent control operation

1. To tell if your range is set for normal or silent operation press and hold **DELAY START**. "-- --" will appear and "**DELAY**" will flash in the display. After 6 seconds "**bEEP On**" or "**bEEP OFF**" will appear in the display.
2. Press **SELF CLEAN** to switch between normal sound operation and silent operation mode. The display will show either "**bEEP On**" or "**bEEP OFF**".

Note: If "**bEEP On**" appears, the control will operate with normal sounds and beeps. If "**bEEP OFF**" appears, the control is in the silent operation mode.

3. Press **START** to accept the change or press **CANCEL** to reject the change.

**Note:** The control will always beep at the end of a minute timer and will beep when a set temperature has been reached, even if the control is set to silent operation.

# SETTING OVEN CONTROLS

## SETTING MINUTE TIMER

The **TIMER ON-OFF** pad controls the Minute Timer feature. The Minute Timer serves as an extra timer in the kitchen that will beep when the set time has run out. It does not start or stop cooking. The Minute Timer feature can be used during any of the other oven control functions. Refer to "Minimum and Maximum Control Pad Settings" for time amount settings.

**To set the Minute Timer** (example for 5 minutes)

1. Press **TIMER ON-OFF**. "-- --" will appear and "Timer" will flash in the display.
2. Press the number pads to set the desired time in the display.
3. Press **START**. The time will begin to count down with "5:00" and "Timer" will stay in the display.

Note: If **START** is not pressed the timer will return to the time of day after 25 seconds.

4. When the set time has run out, "End" and "Timer" will show in the display. The clock will sound with 3 beeps every 5 seconds until **TIMER ON-OFF** is pressed.

**To cancel the Minute Timer before the set time has run out**

1. Press **TIMER ON-OFF**. The display will return to the time of day.

## SETTING + 1 MINUTE FEATURE

The **+1 MIN** pad is used to set the +1 Min feature. When the **+1 MIN** pad is pressed, 1 minute is added to the Minute Timer feature if this feature is already active. If the Minute Timer feature is not active and the **+1 MIN** pad is pressed, the Minute Timer feature will become active and will begin counting down from 1 minute.



## SETTING OVEN LOCKOUT FEATURE

The  pad controls the Oven Lockout feature. The Oven Lockout feature automatically locks the oven door and prevents the oven from being turned on. It does not disable the Minute Timer or the interior oven lights.

**To activate the Oven Lockout feature**

1. Press and hold  for 3 seconds.
2. After 3 seconds "door Loc" will appear, a beep will sound and "DOOR" and  will flash in the display. Once the oven door is locked the "DOOR" and  indicators will stop flashing and remain on along with the "Loc".

**To reactivate normal oven operation:**

1. Press and hold  for 3 seconds. After 3 seconds "door OPn" will appear and a beep will sound. The "DOOR" and  will flash in the display until the oven door has completely unlocked
2. The oven is again fully operational.

## SETTING OVEN CONTROLS

### SETTING QUICK OR POWERPLUS™ PREHEAT

Use the preheat feature when using **single rack baking** to quickly heat the oven to bake temperatures. Use this feature only for standard baking. A reminder tone will sound indicating when to place the food in the oven.

When the oven is finished preheating quick preheat will become just like the bake feature and continue to bake until cancelled.

#### To set the Preheat temperature for 375°F

1. Arrange the interior oven racks.
2. Press **PREHEAT**. "350" will appear in the display. If a preheat of 350°F is needed, press **START**.
3. Press **3 7 5**.
4. Press **START**. "PRE" will be displayed while the oven is preheating.

#### NOTE

While in preheat mode, the convection fan will be activated during the first rise of temperature to allow the oven to reach its target temperature faster. The Bake, Broil and Convection elements will also cycle for a better heat distribution.

### SETTING BAKE

The **BAKE** pad controls normal baking. If a rapid preheating is preferred, refer to the **POWERPLUS™ PREHEAT** feature for instructions. The oven can be programmed to bake at any temperature from 170°F to 550°F (77°C to 288°C).

#### Baking Tips:

- Preheat your oven before using the bake mode.
- During preheat, the 3 elements and the convection fan are used in cycle to quickly heat the oven.
- Use only one rack and center the pans as much as possible on rack 2 or 3.
- If using two racks, place the oven racks in positions 2 and 4.
- Allow 2" to 4" (5,1 to 10,2cm) around the utensil(s) for proper air circulation.
- Be sure the pans do not touch each other, the door, sides or back of the oven.

#### To set the Bake Temperature to 375°F

1. Arrange interior oven racks.
2. Press **BAKE**, "350" will appear in the display. If a bake of 350°F is needed, press **START**.
3. Press **3 7 5**.
4. Press **START**. The actual temperature will be displayed. A beep will sound once the oven temperature reaches 375°F and the display will show "375°".
5. Place food in the oven.

#### NOTE

Pressing **CANCEL** will stop the feature at any time.

#### To change the Bake Temperature (example: changing from 375°F to 425°F)

1. After the oven has already been set to bake at 375°F and the oven temperature needs to be changed to 425°F, press **BAKE** and "375" will appear in the display.
2. Press **4 2 5**.
3. Press **START**.

#### NOTE

During the first rise of temperature, the convection fan will be activated to allow the oven to reach its target temperature faster. The Bake, Broil and Convection elements will also cycle for a better heat distribution.

## SETTING OVEN CONTROLS

### SETTING CONVECTION BAKE

This mode of cooking enables you to obtain the best culinary results when baking with multiple pans and racks. Multiple rack baking may slightly increase cook time for some foods but the overall result is time saved. Some food may cook faster and more evenly with Convection Bake. Convection baking uses the three elements and a fan to circulate the oven's heat evenly and continuously within the oven. The oven can be programmed for Convection baking at any temperature between 170°F to 550°F (77°C to 288°C) with a default temperature of 350°F.

#### Convection Baking Tips:

- Always preheat your oven before using the Convection Bake mode.
- During preheat, the 3 elements and the convection fan are used in cycle to quickly heat the oven.
- If your recipe cooking temperature has already been converted for convection baking there is no need to reduce your oven temperature. If your recipe has not had the temperature converted for convection baking you can easily reduce using the Convection Convert feature. Please see Convection Convert section on next page for further instruction on temperature conversion.
- Use tested recipes with times adjusted for convection baking when using this mode. Time reductions will vary depending on the amount and type of food to be cooked.
- When using Convection Bake with a single rack, place oven rack in position 2 or 3. If cooking on multiple racks, place the oven racks in positions 2 and 4; 1, 3 (offset rack) and 4 or 2, 3 and 4 if there is no offset rack supplied
- Most bakeries (except cakes) should be baked on pans with no sides or very low sides to allow heated air to circulate around the food.
- Food baked on pans with a dark finish will cook faster.

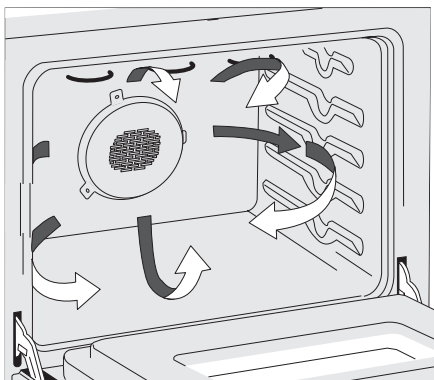

**Air circulation during Convection Bake**  
Figure 1

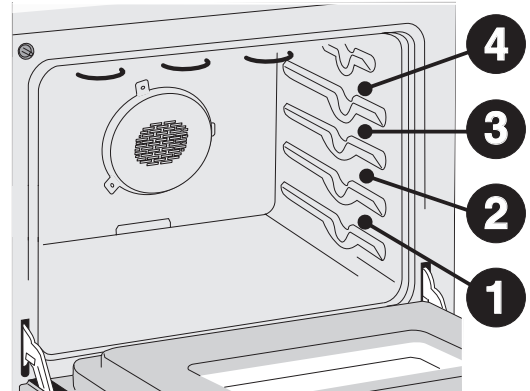

**Oven Rack Positions**  
Figure 2

#### To set the oven for Convection Bake and temperature to 375°F

1. Arrange interior oven racks.
2. Press **CONVECT**. "**CONVECT**" and "**BAKE**" will flash and "**350**" will appear in the display. If a Convection Bake of 350°F is needed, press **START**.
3. Press **3 7 5**. "**CONVECT**" and "**BAKE**" will keep flashing and "**375**" will appear in the display.
4. Press **START**. The actual oven temperature and the fan icon will be displayed. A beep will sound once the oven temperature reaches 375°F and the display will show "**375°**", "**CONVECT**", "**BAKE**" and the fan icon.
5. Place food in the oven.

#### **NOTE**

Pressing **CANCEL** will stop the feature at any time.

#### **Benefits of Convection Bake:**

- Multiple rack baking.
- Some foods cook faster, saving time and energy.
- No special pans or bakeware needed.

#### **NOTE**

The convection fan will start **AS SOON AS** the oven is set for Convection Bake. The display will show an icon of rotating fan within a square. This rotating fan icon indicates when the Convection Fan is operating. The Bake, Broil and Convection elements will also cycle for a better heat distribution.

## SETTING OVEN CONTROLS

### SETTING CONVECTION CONVERT

The **Convect Convert** pad is used to automatically convert a standard baking recipe for convection baking. When set properly, this feature is designed to display the actual converted (reduced) temperature in the display. Convect Convert may ONLY be used with a Convection Bake cooking mode. It can be used with the features Delay Start and Bake Time (see their sections for directions). If convection conversion is used with the Bake Time and Delay Start features, "**CF**" (check food) will be displayed when 75% of the bake time complete. At this time the oven control will sound 3 long beeps at regular intervals until baking has finished. When the bake time has completely finished the control will display "**End**" and beep at regular interval until the **CANCEL** pad is pressed.

#### NOTE

To use this feature with the **BAKE TIME** option, the **BAKE TIME** pad must be pressed before the **CONVECT CONVERT** pad.

#### To set the oven for Convection Bake with a standard baking recipe temperature of 400°F:

1. Arrange interior oven racks.
2. Press **CONVECT**. "**CONVECT**" and "**BAKE**" will flash and "**350**" will appear in the display.
3. Press **400**. "**CONVECT**" and "**BAKE**" will keep flashing and "**400**" will appear in the display.
4. Press **CONVECT CONVERT**. As soon as the convection convert pad is pressed, the oven will start heating. The temperature displayed will be 25°F lower than what it used to be. The actual oven temperature and the fan icon will be displayed. A beep will sound once the oven temperature reaches 375°F and the display will show "**375**", "**CONVECT**", "**BAKE**" and the fan icon.
5. Place food in the oven.

#### NOTE

When using a Bake Time under 20 minutes, the Convect Convert will not beep and display the "**CF**" message.

### SETTING CONVECTION ROAST

This mode is best for cooking tender cuts of beef, lamb, park and poultry. Use this mode when cooking speed is desired. The Convection Roasting gently browns the exterior and seals in the juices. Convection roasting uses the hidden bake element, the hidden convection element, the broil element and a fan to circulate the oven's heat evenly and continuously within the oven. The oven can be programmed for Convection Roasting at any temperature between 170°F to 550°F (77°C to 288°C) with a default temperature of 350°F.

#### Convection Roasting Tips:

- Use a broiler pan and grid, and a roasting rack (available by mail order). The broiler pan will catch grease spills and the grid will help prevent spatters. The roasting rack will hold the meat.
- Place an oven rack on rack position 1 (offset rack, if available).
- No preheat is needed in convection roast.
- Make sure the roasting rack is securely seated on the grid in the broiler pan. The roasting rack fits on the grid allowing the heated air to circulate under the food for even cooking and helps to increase browning on the underside (available by mail order only).
- There is no need to reduce the convection temperature or to use the Convection Convert feature with this cooking mode.
- **DO NOT** use the broiler pan without the grid or cover the grid with aluminum foil (available by mail order).
- Always pull the rack out to the stop position before removing food.
- Position food (fat side up) on the roasting rack.

#### To set a Convection Roast Temperature of 375°F:

1. Arrange oven racks and place food in the oven.
2. Press **CONVECT**; "**350**" will be displayed; "**CONVECT**" and "**BAKE**" will flash.
3. Press **CONVECT** again; "**350**" will be displayed; "**CONVECT**" and "**ROAST**" will flash.
4. Enter the desired roasting temperature using the number pads **3 7 5**.
5. Press **START**; The actual oven temperature will be displayed, "**CONVECT**", "**ROAST**" and the fan icon will be displayed. The Bake, Broil and Convection elements will also cycle for a better heat distribution.

#### NOTE

Pressing **CANCEL** will stop the feature at any time.

# SETTING OVEN CONTROLS

## SETTING CONVECTION BROIL

Use this mode for thicker cuts of meat, fish and poultry. The Convection Broiling gently browns the exterior and seals in the juices. Convection broiling uses the broil element and a fan to circulate the oven's heat evenly and continuously within the oven. The oven can be programmed for Convection Broiling at any temperature between 300°F to 550°F (204°C to 288°C) with a default temperature of 550°F.

### Convection Broiling Tips:

- For optimum browning, preheat the broil element for 5 minutes.
- Broil one side until the food is browned; turn and cook on the second side. Season and serve.
- Always pull the rack out to the "stop" position before turning or removing food.
- Always use a broiler pan and its grid when broiling (available by mail order). It allows the dripping grease to be kept away from the high heat of the broil element.
- **DO NOT** use the broil pan without the insert (available by mail order). **DO NOT cover the broil pan insert with foil.** The exposed grease could catch fire.
- If using a Searing Grill (available by mail order), preheat the grill for 5 to 10 minutes before placing your meat.
- Convection broiling is generally faster than conventional broiling. Check for doneness at the minimum recommended time.

### WARNING

Should an oven fire occur, leave the oven door closed and turn off the oven. If the fire continues, throw baking soda on the fire or use a fire extinguisher. **DO NOT** put water or flour on the fire. Flour may be explosive and water can cause a grease fire to spread and cause personal injury.

### To set a Convection Broil Temperature of 500°F:

1. Arrange oven racks.
2. Press **CONVECT**; "350" will be displayed; "CONVECT" and "BAKE" will flash.
3. Press **CONVECT** again; "350" will be displayed; "CONVECT" and "ROAST" will flash.
4. Press **CONVECT** again; "550" will be displayed; "CONVECT" and "BROIL" will flash.
5. Enter the desired roasting temperature using the number pads **5 0 0**.
6. Press **START**; "550", "CONVECT", "BROIL" and the fan icon will be displayed.
7. After **5** minutes of preheat, place food in the oven.

### NOTE

Pressing **CANCEL** will stop the feature at any time.

Accessories available via the enclosed brochure:

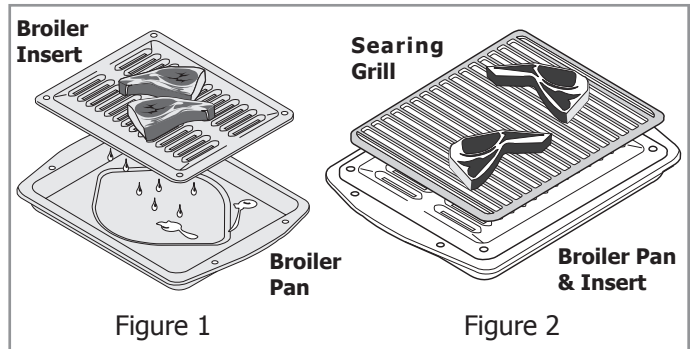

### CAUTION

Always use this cooking mode with the oven door **closed** or the convection fan will not turn on.

## Electric Oven Convection Broiling Table Recommendations

Food Item	Rack Position	Temperature Setting	Cook Time		Doneness
			1st side	2nd side	
Steak 1" thick	4th	550° F	6:00	4:00	Rare
	4th	550° F	7:00	5:00	Medium
Pork Chops 3/4" thick	4th	550° F	8:00	6:00	Well
Chicken - Bone In	3rd	450° F	20:00	10:00	Well
Chicken - Boneless	4th	450° F	8:00	6:00	Well
Fish	3rd	500° F	13:00	-	Well
Shrimp	3rd	550° F	5:00	-	Well
Hamburger 1" thick	4th	550° F	9:00	7:00	Medium
	4th	550° F	10:00	8:00	Well



# SETTING OVEN CONTROLS

## SETTING BAKE TIME

Bake Time allows the oven to be set to cook for a specific length of time and shut off automatically.

The oven will shut off and will beep when the countdown is finished. This feature can be used with Bake, Convection Bake, Convection Roast, Pizza and Chicken Nuggets cooking modes.

**To program the oven to begin baking immediately and to shut off automatically (example: BAKE at 350°F for 30 minutes):**

1. Be sure the clock is set for the correct time of day.
2. Arrange interior oven rack(s) and place the food in the oven.
3. Press **BAKE**, "350" will appear in the display.
4. Press **START**. The actual oven temperature will appear in the display.
5. Press **BAKE TIME**. "-- --" will appear in the display.
6. Enter the desired baking time by pressing **3 0**.
7. Press **START**. Once the Timed Bake feature has started, the current time of day will appear in the display.

### NOTE

Baking time can be set for any amount of time between 1 minute to 6 hours.

Press **CANCEL** when baking has finished or at any time to cancel the Timed Bake feature. A Bake Time of "0" minute can also be entered to cancel the Bake Time feature and keep the oven in its current cooking mode.

### NOTE

After the Timed Bake feature has activated, press **BAKE TIME** to display the bake time remaining in the Bake Time mode. Once Bake Time has started baking, a beep will sound when the oven temperature reaches the set temperature.

### **When the timed bake finishes:**

1. "End" and the time of day will show in display. The oven will shut off automatically.
2. The control will beep 3 times. The control will continue to beep 3 times every 30 seconds until **CANCEL** is pressed.

### CAUTION

Use caution with the **DELAY START** features. Use the automatic timer when cooking cured or frozen meats and most fruits and vegetables. Foods that can easily spoil such as milk, eggs, fish, meat or poultry, should be chilled in the refrigerator first. Even when chilled, they should not stand in the oven for more than 1 hour before cooking begins, and should be removed promptly when cooking is completed.

## SETTING DELAY START

The **BAKE, CONVECTION BAKE, BAKE TIME** and **DELAY START** pads control the Delayed Timed Bake feature. The automatic timer of the Delayed Timed Bake will turn the oven **on and off** at the time you select in advance.

### NOTE

If your clock is set for normal 12 hour display mode the Delayed Start can never be set to start more than 12 hours in advance. To set for Delayed Start 12-24 hours in advance, set the control for the 24 hour time of day display mode.

**To program the oven for a delayed BAKE start time (example: baking at 375°F starting at 5:30):**

1. Be sure that the clock is set with the correct time of day.
2. Arrange interior oven rack and place the food in the oven.
3. Press **BAKE**. "350" will appear in the display.
4. Enter the desired temperature; pressing **3 7 5**.
5. Press **START**. The actual oven temperature will appear in the display.
6. Press **DELAY START**.
7. Enter the desired start time; pressing **5 3 0**.
8. Press **START**. When Delayed Time Bake starts, the set oven temperature will appear, "DELAY", "BAKE" and the current time of day will appear in the display.

### NOTE

If it is desired to have the oven shut off automatically after a set time; enter a **BAKE TIME** at this step.

9. When the desired start time is reached, the actual oven temperature appears in display and "DELAY" disappears. Oven starts to bake at the previously selected temperature.

Press **CANCEL** when baking has completed or at any time to cancel the Delayed Time Bake feature.



# SETTING OVEN CONTROLS

## SETTING WARM

This mode is best for keeping oven baked foods warm for serving after cooking has finished. The **WARM** pad turns ON the Warm feature and will maintain an oven temperature of 170°F (77°C). The Warm feature will keep oven baked foods warm for serving up to 3 hours after cooking has finished.

**After 3 hours the Warm feature will shut the oven OFF.** The Warm feature may be used without any other cooking operations or can be set to turn ON automatically after a **BAKE TIME** or **DELAYED BAKE TIME**.

### Warm Tips:

- Always start with hot food.
- Do not use the Warm feature to heat cold food.
- Food in heat-safe glass and glass ceramic containers may need higher temperature settings compared to food in regular containers.
- Avoid repeated openings of the oven, it will allow hot air to escape and the food to cool.
- Aluminum foil may be used to cover food to increase moisture content.

### To set Warm:

1. Arrange interior oven racks and place food in oven.
2. Press **WARM**. "Hld" will appear in the display.  
Note: If no pad is touched within 25 seconds the request to turn ON Warm feature will be cancelled.
3. Press **START**. The oven icon will appear in the display.
4. To turn OFF the WARM at any time press **CANCEL**.

### To set Warm to turn ON automatically:

1. Arrange interior oven racks and place food in oven. Set the oven properly for **Bake Time or Delayed Bake Time**. (See their respective sections for more details).
2. Press **WARM**.  
Note: If no pad is touched within 25 seconds, the request to turn ON Warm feature will be cleared.
3. Press **START**. "Hld" will disappear and the temperature will be displayed. The Warm mode is set to turn ON automatically after Timed Bake has finished.
4. To turn the Warm feature OFF at any time press **CANCEL**.

## NOTE

Pressing **CANCEL** will stop the feature at any time.

## SETTING PIZZA

The **PIZZA** pad has been designed to give optimum cooking performance when cooking your favorite pizza. The Pizza pad let you choose a preset between a frozen pizza (425°F) and a fresh pizza (400°F). If needed, a different target temperature than the presets can be entered. Some fresh pizza request using a broil feature for a few minutes, but this is not part of the Pizza pad presets.

### Pizza Tips:

- Follow the instructions on the box for preheating and baking times.
- For optimum cooking results, only bake one pizza at once on rack position 2.
- Check the pizza at 75% of the maximum cook time listed on the package.

### To set Pizza for a frozen pizza:

1. Arrange interior oven racks.
2. Press **PIZZA** pad. "Fro" will appear in the display. If a different temperature than 425°F is needed, enter the temperature now, using the keypad digits.
3. Press **START**. The fan icon and the actual oven temperature will appear in the display.
4. Place the pizza in the oven when the beep is heard.
5. If needed, enter a **BAKE TIME** (see its section for further details).
6. To turn OFF the Pizza feature at any time press **CANCEL**.

### To set Pizza for a fresh pizza:

1. Arrange interior oven racks.
2. Press **PIZZA** pad **twice**. "Frh" will appear in the display. If a different temperature than 400°F is needed, enter the temperature now, using the keypad digits.
3. Press **START**. The fan icon and the actual oven temperature will appear in the display.
4. Place the pizza in the oven when the beep is heard.
5. If needed, enter a **BAKE TIME** (see its section for further details).
6. To turn OFF the Pizza feature at any time press **CANCEL**.

## SETTING OVEN CONTROLS

### SETTING CHICKEN NUGGETS

The **NUGGETS** pad has been designed to give optimum cooking performance when cooking your favorite chicken nuggets. The Nuggets pad is preset for a Convection Bake at (400°F) with a Bake Time of 18 minutes, ending with a Keep Warm setting. If needed, a different target temperature or Bake Time than the presets can be entered.

#### Chicken Nuggets Tips:

- For most type of chicken nuggets, preheating is not required and the preset baking time of the feature will give you optimum results.
- For larger chicken tenders, follow the preheating and baking instructions on the box and only use a single rack.
- For a single rack, use rack position 2.
- For multiple racks, use rack positions 2 and 4.

#### To set Nuggets:

1. Arrange interior oven racks and place food in oven.
2. Press **NUGGETS** pad. "CHI" will appear in the display. If a different temperature than 400°F is needed, enter the temperature now, using the keypad digits. If a different Bake Time than 18 minutes is required, press **BAKE TIME** and enter the desired time (or 0 for an untimed baking).
3. Press **START**. The fan icon will appear in the display.
4. To turn OFF the Nuggets feature at any time press **CANCEL**.

#### NOTE

The Nuggets feature is automatically programmed to activate the Keep Warm feature when the cooking is finished. "HLD" will be displayed for a maximum of 3 hours. See the Keep Warm feature for more information.

### SETTING FAVORITE (some models)

The Favorite setting allow you to save your most frequently used or most complex cooking sequence. This feature will save the cooking mode, the target temperature and the bake time (if any). The oven can recall a cooking sequences from its internal memory, which is easily accessible from a one touch button. This function can be used with Bake, Convection Bake, Convection Roast and Preheat.

**To save a Favorite** (example is a 450°F Bake for 30 minutes):

1. Press **BAKE**. The default temperature will appear in the display.
2. Enter temperature needed; **4 5 0**.
3. Press **START**.
4. Press **BAKE TIME**.
5. Enter time needed; **3 0**.
6. Press **START**.
7. Press and hold for 3 seconds **FAVORITE** pad. The ♥ icon will be shown to confirm your setting has been saved.

#### To recall a Favorite:

1. Press **FAVORITE** pad.
2. Press **START**.

#### NOTE

Recalling a Favorite can only be done when the oven is not currently in operation.

#### To overwrite a Favorite:

1. To overwrite Favorite simply start a new cooking sequence and save it as shown in example above. The new Favorite settings will overwrite the old ones.

#### To delete a Favorite:

1. Press the **FAVORITE** pad to delete for **3 seconds** while the oven is not in operation and no cooking mode has been set. The ♥ icon will disappear.

# SETTING OVEN CONTROLS

## SETTING BROIL

This mode is best for meats, fish and poultry up to 1" thick. Broiling is a method of cooking tender cuts of meat by direct heat under the broil element of the oven. The high heat cooks quickly and gives a rich, brown outer appearance. The **BROIL** pad controls the Broil feature. An optional Searing Grill, Broiler Pan and Insert are available via the enclosed accessories brochure (Figure 2 & 3). The optional broil pan and broil pan insert used together allow dripping grease to drain and be kept away from the high heat of the oven broiler. The oven can be programmed to broil at any temperature from 400°F to 550°F with a default temperature of 550°F.

### Broiling Tips:

- For optimum browning, preheat the broil element for 5 minutes.
- Broil one side until the food is browned; turn and cook on the second side. Season and serve.
- Always pull the rack out to the "stop" position before turning or removing food.
- Always use the broiler pan and its cover when broiling. It allows the dripping grease to be kept away from the high heat of the broil element (see Figure 2).
- For best broiling results, broil with the oven door in the broil stop position (see Figure 1).
- If using a Searing Grill (available by mail order), preheat the grill for 5 to 10 minutes before placing your meat.
- **DO NOT** use the broil pan without the insert. **DO NOT cover the broil pan insert with foil.** The exposed grease could catch fire.

Accessories available via the enclosed brochure:

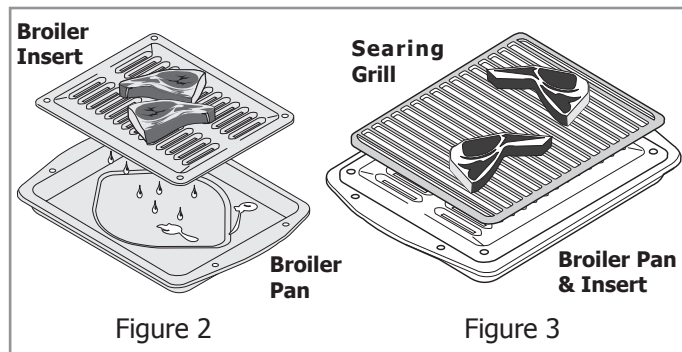

### To set a Broil of 500°F:

1. Place the broiler pan insert on the broiler pan. Then place the food on the broiler pan insert. **DO NOT** use the broiler pan without the insert. **DO NOT** cover the broiler insert with foil. The exposed grease could ignite.
2. Arrange the interior oven rack.
3. Press **BROIL**. "550" will appear in the display.
4. Press **5 0 0**. If a lower broil temperature is desired (minimum broil temperature setting is 400°F), press the desired temperature before continuing to step 5.
5. Press **START**. The oven will begin to broil. "500°" will appear in the display.
6. Preheat for 5 minutes before broiling.
7. Place the broiler pan on the rack. Be sure to center the broiler pan directly under the broiler element. **Make sure the oven door is in the broil stop position (See Figure 1).**
8. See broiling tips.
9. To stop broiling press **CANCEL**.

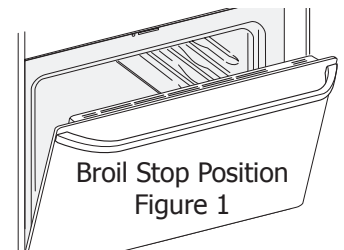

### NOTE

To assure your electronic controls safety when broiling with the oven door in broil position, a high speed cooling fan will blow air through the trims above the door(s).

### WARNING

Should an oven fire occur, leave the oven door closed and turn off the oven. If the fire continues, throw baking soda on the fire or use a fire extinguisher. **DO NOT** put water or flour on the fire. Flour may be explosive and water can cause a grease fire to spread and cause personal injury.

### Electric Oven Broiling Table Recommendations

Food Item	Rack Position	Temperature Setting	Cook Time		Doneness
			1st side	2nd side	
Steak 1" thick	4th	550° F	6:00	4:00	Rare
	4th	550° F	7:00	5:00	Medium
Pork Chops 3/4" thick	4th	550° F	8:00	6:00	Well
Chicken - Bone In	3rd	450° F	20:00	10:00	Well
Chicken - Boneless	4th	450° F	8:00	6:00	Well
Fish	3rd	500° F	13:00	-	Well
Shrimp	3rd	550° F	5:00	-	Well
Hamburger 1" thick	4th	550° F	9:00	7:00	Medium
	4th	550° F	10:00	8:00	Well

## SETTING OVEN CONTROLS

### SETTING THE SABBATH FEATURE (for use on the Jewish Sabbath & Holidays)

The **BAKE TIME** and **DELAY START** pads are used to set the Sabbath feature. The Sabbath feature may only be used with the **BAKE** pad. The oven temperature may be set higher or lower after setting the Sabbath feature (the oven temperature adjustment feature should be used only during Jewish Holidays), however the display will not visibly show or provide any audible tones indicating whether the change occurred correctly. Once the oven is properly set using Bake with the Sabbath feature active, the oven will remain continuously ON until cancelled. This will override the factory preset 6-Hour Energy Saving feature.

If the oven light will be needed during the Sabbath, press **OVEN LIGHT**  before activating the Sabbath feature. Once the oven light is turned ON and the Sabbath feature is active, the oven light will remain ON until the Sabbath feature is turned OFF. If the oven light needs to be OFF, be sure to turn the oven light OFF before activating the Sabbath feature.

### To Program the Oven to Begin Baking Immediately & activate the Sabbath feature (example: baking at 350°F)

1. Be sure that the clock is set with the correct time of day.
2. Place the food in the oven.
3. Press **BAKE**. "350°" appears in the display.
4. Press **START**. The actual oven temperature appears in the display.
5. If you desire to set the oven control for a **Bake Time** or **Delayed Bake Time** do so at this time. If not, skip this step and continue to step 7. Refer to the **Bake Time / Delay Start** section for complete instructions. Remember the oven will shut down after using **Bake Time** or **Delay Start** and therefore may only be used once during the Sabbath/Jewish Holidays.
7. Press and hold both the **BAKE TIME** and **DELAY START** pads for at least **3 seconds**. "Sab" will appear in the display. Once "Sab" appears in the display the oven control will no longer beep or display any further changes and the oven is properly set for the Sabbath feature.
8. The oven may be turned OFF at any time by first pressing **CANCEL** pad (this will turn the oven OFF only). To turn OFF the Sabbath feature press and hold both the **BAKE TIME** and **DELAY START** pads for at least **3 seconds**. "Sab" will disappear from the display.

### IMPORTANT

It is not advised to attempt to activate any other program feature other than **BAKE** while the Sabbath feature is active. ONLY the following key pads will function after setting the Sabbath feature; **0 to 9, BAKE, START & CANCEL**. All other keypads should not be used once the Sabbath feature is properly activated.

### NOTE

You may change the oven temperature once baking has started by pressing **BAKE**, the numeric key pads for the temperature you want (example for 425°C press **4 2 5**) and then pressing **START twice** (for Jewish Holidays only). Remember that **the oven control will no longer beep or display any further changes** once the oven is set for the Sabbath feature.

Should you experience a power failure or interruption, the oven will shut off. When power is returned, "SF" (Sabbath Failure) will be shown in the oven display. The oven will not turn back on automatically. If your food was nearly fully cooked, you may allow the trapped heat in the oven to finish the cooking process. Otherwise, you should remove the food when the power failure occurs, because you may only start the oven once during the Sabbath/Jewish Holidays. After the Sabbath observance, turn OFF the Sabbath feature and be sure that all the control knobs are at the OFF position. The appliance may be used again with all normal functions. After the Sabbath observance turn OFF the Sabbath feature. Press and hold both the **BAKE TIME** and **DELAY** pads for at least **3 seconds**. "Sab" will disappear from the display and the oven may be used with all normal functions. For further assistance, guidelines for proper usage, and a complete list of models with the Sabbath feature, please visit the web at <http://www.star-k.org>.

### ADJUSTING OVEN TEMPERATURE

The temperature in the oven has been pre-set at the factory. When first using the oven, be sure to follow recipe times and temperatures. If you think the oven is cooking too hot or too cool for the temperature you select, you can adjust the actual oven temperature to be more or less than what is displayed. Before adjusting, test a recipe by using a temperature setting that is higher or lower than the recommended temperature. The baking results should help you to decide how much of an adjustment is needed.

#### NOTE

The oven temperature adjustments made with this feature will not change the Self-Clean cycle temperature or the Broil temperature.

#### To adjust the oven temperature higher

1. Press **BAKE** for 6 seconds. "**UPO 0**" (offset temperature setting, 0 by default) will appear in the display.
2. To increase the temperature use the number pads to enter the desired change (Example 30°F) **3 0**. The temperature may be increased as much as 35°F (19°C).
3. Press **START** to accept the temperature change and the display will return to the time of day. Press **CANCEL** to reject the change if necessary.

#### To adjust the oven temperature lower

1. Press **BAKE** for 6 seconds. "**UPO 0**" (offset temperature setting, 0 by default) will appear in the display.
2. To decrease the temperature use the number pads to enter the desired change (Example -30°F) **3 0** and then press **SELF CLEAN** to toggle the minus sign. The temperature may be decreased as much as 35°F (19°C).
3. Press **START** to accept the temperature change and the display will return to the time of day. Press **CANCEL** to reject the change if necessary.

#### NOTE

The oven temperature adjustments are permanent and will stay forever in the unit memory unless you manually change it again. Even a power outage will not reset these changes. Follow the same procedure again if you wish to change it to a different setting.

### OVEN LIGHT

The oven is equipped with 2 oven lights. The oven lights will turn on automatically, when the oven door is opened. The oven light may be turned on when the door is closed by using the oven light pad located on the control panel. The oven light key will toggle the lights at full intensity.

#### To toggle the Oven Lights ON and OFF:

1. Press **OVEN LIGHT** .

The interior oven lights are covered with a glass shield held by a wire holder. The glass shield must be in place whenever the oven is in use.

To change the interior oven lights, see "Changing the oven light" in the **Care & Cleaning** section.



# SETTING OVEN CONTROLS

## SELF-CLEANING

A self-cleaning oven cleans itself with high temperatures (well above normal cooking temperatures) which eliminate soils completely or reduces them to a fine powdered ash you can wipe away with a damp cloth.

### ➔ IMPORTANT

Adhere to the following cleaning precautions:

- **DO NOT** use oven cleaners or oven protective coatings in or around any part of the oven interior.
- **DO NOT** clean the oven door gasket. The woven material of the oven door gasket is essential for a good seal. Care should be taken not to rub, damage or remove the gasket.
- **DO NOT** use any cleaning materials on the oven door gasket. Doing so could cause damage.
- **Remove the broiler pan and insert, all utensils and ANY ALUMINUM FOIL. These items cannot withstand high cleaning temperatures and will melt.**
- **Completely remove ALL OVEN RACKS and ANY ACCESSORIES. If the oven racks are not removed, they will lose their special coating properties and will no longer slide in and out of the oven cavity effortlessly.**
- **Remove any excessive spillovers** in the oven cavity **before** starting the Self-Cleaning cycle. To clean, use hot, soapy water and a cloth. Large spillovers can cause heavy smoke or fire when subjected to high temperatures. **DO NOT** allow food spills with a high sugar or acid content (such as milk, tomatoes, sauerkraut, fruit juices or pie filling) to remain on the surface as they may leave a dull spot even after cleaning.
- Clean any soil from the oven frame, the door liner outside the oven door gasket and the small area at the front center of the oven bottom. These areas heat sufficiently to burn soil on. Clean with soap and water.



## What to Expect during Cleaning

While the oven is in operation, the oven heats to temperatures much higher than those used in normal cooking. Sounds of metal expansion and contraction are normal. Odor is also normal as the food soil is being removed. Smoke may appear through the oven vent.

If heavy spillovers are not wiped up before cleaning, they may flame and cause more smoke and odor than usual. This is normal and safe and should not cause alarm. If available, use an exhaust fan during the self-cleaning cycle.

### ! CAUTION

To avoid possible burns use care when opening the oven door after the Self-Cleaning cycle. Stand to the side of the oven when opening the door to allow hot air or steam to escape.

During the Self-Cleaning cycle, the outside of the range can become very hot to the touch. **DO NOT** leave small children unattended near the appliance.

The health of some birds is extremely sensitive to the fumes given off during the Self-Cleaning cycle of any range. Move birds to another well-ventilated room.

**DO NOT** line the oven walls, racks, bottom or any other part of the range with **aluminum foil**. Doing so will destroy heat distribution, produce poor baking results and cause permanent damage to the oven interior (aluminum foil will melt to the interior surface of the oven).

**DO NOT** force the oven door open. This can damage the automatic door locking system. Use caution when opening the door after the Self-Cleaning cycle is completed. The oven may still be **VERY HOT**.

### 📌 NOTE

See additional cleaning information for the oven door in the **General Care & Cleaning** section.

# SETTING OVEN CONTROLS

## SETTING SELF-CLEAN CYCLE TIME LENGTH

The **SELF CLEAN** pad controls the Self-Cleaning feature. If you are planning to use the oven directly after a self-clean cycle remember to allow time for the oven to cool down and the oven door to unlock. This normally takes about one hour. So a 3 hour self-clean cycle will actually take about 4 hours to complete.



\*It is recommended to use a 2 hour self-clean cycle for **light soils**, a 3 hour cycle for **average soils**, and a 4 hour cycle for **heavy soils** (to assure satisfactory results).

### To set the controls for a 3 hour Self-Cleaning cycle to start immediately and shut off automatically

1. Be sure the clock is set with the correct time of day and the oven door is closed.
2. Press **SELF CLEAN**. "CLn" and "3:00" HR will show in the display. The control will automatically clean for a 3 hour period (default self-cleaning cycle time).

### NOTE



If a 2 or 4 hour clean time is desired, press **SELF CLEAN** multiple times to toggle between 2, 3 or 4 hours.

3. Press **START**. "door Loc" will appear, a beep will sound and "DOOR" and  icon will flash; the letters "CLn" will appear in the display as soon as the door is locked.
4. As soon as the control is set, the motor driven oven door lock will begin to close automatically. Once the door has been locked the "DOOR" indicator light and  icon will stop flashing and remain on. Also, the oven icon will appear in the display.

### NOTE

Allow about 15 seconds for the oven door lock to close.

### When the Self-Clean Cycle is Completed

1. "HOT" will appear in the display. The time of day, "DOOR" and  icon will remain in the display.
2. Once the oven has cooled down for approximately 1 HOUR, "door OPn" will appear and "DOOR" and  icon will flash until the door is unlocked, the oven door can then be opened and the timer will revert back to the time of the day.

### Stopping or Interrupting a Self-Cleaning Cycle

If it becomes necessary to stop or interrupt a self-cleaning cycle due to excessive smoke or fire in the oven:

1. Press **CANCEL**.
2. The oven door can only be opened after the oven has cooled down for approximately 1 HOUR, "door OPn" will appear and the "DOOR" and  icon will flash until the door is unlocked, the oven door can then be opened and the timer will revert back to the time of the day.



The **SELF CLEAN** and **DELAY START** pads controls the Delayed Self-Clean operation. The automatic timer will turn the oven **on and off** at the time you select in advance.

### To set the control for the Self-Cleaning Cycle to start at a delayed time and shut off automatically (example: 3 hour self-clean cycle to start at 4:30)



1. Be sure the clock is set with the correct time of day and the oven door is closed.
2. Press **SELF CLEAN**. "CLn" and "3:00" HR will show in the display. The control will automatically clean for a 3 hour period.

### NOTE

If a 2 or 4 hour clean time is desired, press **SELF CLEAN** multiple times to toggle between 2, 3 or 4 hours.

3. Press **START**. "door Loc" will appear, a beep will sound and the "DOOR" and  icon will flash; the letters "CLn" will appear in the display as soon as the door is locked.
4. Press **DELAY START**. Enter the desired start time using the number pads **4 3 0**.
5. Press **START**. "DELAY", "DOOR" and  will remain on.
6. As soon as the control is set, the motor driven oven door lock will begin to close automatically. Once the door has been locked the "DOOR" and  icon indicator light will quit flashing and remain on.
7. The control will start the self-cleaning at the set start time, for the period of time previously selected. At that time, the icon "DELAY" will go out; "CLn" and oven icon will appear in the display.

### When the Self-Clean Cycle is Completed

1. "HOT" will appear in the display. The time of day, the "DOOR" and  icon will remain in the display.
2. Once the oven has cooled down for approximately 1 HOUR, "door OPn" will appear and the "DOOR" and  icon will flash until the door is unlocked, the oven door can then be opened and the timer will revert back to the time of the day.

### Stopping or Interrupting a Self-Cleaning Cycle

If it becomes necessary to stop or interrupt a self-cleaning cycle due to excessive smoke or fire in the oven:

1. Press **CANCEL**.
2. The oven door can only be opened after the oven has cooled down for approximately 1 HOUR, "door OPn" will appear and the "DOOR" and  icon will flash until the door is unlocked, the oven door can then be opened and the timer will revert back to the time of the day.



# SETTING KEEP WARM DRAWER CONTROL

## Keep warm drawer rack positions

The rack can be used in 2 ways:

- In the **upright position** (Figure 1) to allow low profile food items to be placed both under and on top of the rack (for example, rolls or biscuits on top of the rack and a casserole dish underneath).
- In the **downward position** (Figure 2) to allow you to place light weight food items and empty dishware (for example, rolls or pastries and dinner plates) on the rack.

Set the keep warm drawer rack in either position.

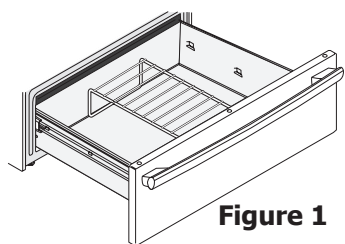

Figure 1

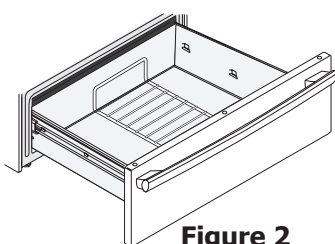

Figure 2

## Operating the keep warm drawer

The purpose of the keep warm drawer is to keep hot cooked foods at serving temperature. Always start with hot food. It is not recommended to heat cold food in the keep warm drawer. All food placed in the keep warm drawer should be covered with a lid or aluminum foil to maintain quality. Do not use plastic wrap to cover food. Plastic may melt onto the drawer and be very difficult to clean. Use only utensils and cookware recommended for oven use in the keep warm drawer.

### CAUTION

Always use potholders or oven mitts when removing food from the keep warm drawer as cookware and plates will be hot and you can be burned.

## To set the keep warm drawer controls

The control and indicator lights for the keep warm drawer features are located on the control panel. The temperatures are approximate, and are designated by HI (high), MED (medium) and LO (low).

1. Touch the **on•off** pad (see Figure 6) at the keep warm drawer control position. The keep Warm drawer indicator light will flash. Note: If no further pads are touched within 25 seconds the request to power the keep warm drawer ON will clear.
2. Set the desired power level. Touch **▲** once to turn ON the power level for HI (see Figure 3) or **▼** to turn ON the power level for LO (see Figure 5). The keep warm drawer indicator light located beside the **on•off** pad will turn ON steady.
3. Each touch of the **▼** or **▲** pads will decrease or increase through 5 power levels from HI (see Figure 3) to MED (see Figure 4) to LO (see Figure 5).

**Note:** For best results, preheat the keep warm drawer before adding the food. An empty drawer will preheat in approximately 15 minutes.

4. When the food is ready for removal, touch the **on•off** pad once to turn the keep warm drawer OFF. The keep warm drawer indicator light will turn OFF.



Figure 3

Figure 4

Figure 5



Figure 6

### NOTE

The keep warm drawer is inoperable during the self-clean cycle.

The keep warm drawer is equipped with a latch which may require extra force when opening and closing the drawer.

## Keep warm drawer temperature selection

Recommended keep warm drawer settings table is shown below. If a particular food is not listed, start with the MED setting. If more crispness is desired, remove the lid or aluminum foil from the food. Most foods can be kept at serving temperatures on the MED setting. When a combination of foods are to be kept warm (for instance, meat with 2 vegetables and rolls), use the HI setting. To avoid heat loss, do not open the keep warm drawer while in use.



Keep warm drawer recommended food settings table

Food Item	Setting
Bacon, Hamburger Patties	HI
Poultry, Pork Chops	HI
Fried Foods, Pizza	HI
Gravies, Casseroles	MED
Vegetables, Eggs	MED
Roasts (Beef, Pork, Lamb)	MED
Biscuits, Pastries	MED
Rolls, hard	MED
Rolls (soft)	LO
Empty Dinner Plates	LO

## CARE & CLEANING (Cleaning Chart)

### Cleaning various parts of your appliance

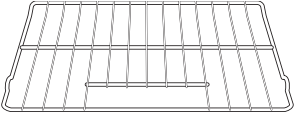
Before cleaning any part of the appliance, be sure all controls are turned off and the appliance is COOL. REMOVE SPILLOVERS AND HEAVY SOILING AS SOON AS POSSIBLE. REGULAR CLEANING WILL REDUCE THE NUMBER OF MAJOR CLEANING LATER.

Surfaces	How to Clean
Aluminum (trim pieces) & Vinyl	Use hot, soapy water and a cloth. Dry with a clean cloth.
Glass, Painted and Plastic Body Parts, Control Knobs & Decorative Trim Pieces	Using a soft cloth, clean with mild dish detergent and water or a 50/50 solution of vinegar and water. Follow by rinsing the area with clean water; dry and polish with a soft cloth. Glass cleaners may be used if sprayed on a soft cloth first. DO NOT spray liquids directly on the control pad and display area. Do not use large amounts of water on the control panel - excess water on the control area may cause damage to the appliance. Do not use other liquid cleaners, abrasive cleaners, scouring pads, or paper towels - they will damage the finish. To remove control knobs, turn to the OFF position; grasp firmly and pull straight off the shaft. To replace knobs after cleaning, line up the flat sides of both the knob and the shaft; then push the knob into place.
Control Panels	Before cleaning the control panel, turn all controls to OFF and remove the control knobs. To remove, pull each knob straight off the shaft. Clean as instructed above. Squeeze excess water from the cloth before wiping the panel; especially when wiping around the controls. Excess water in or around the controls may cause damage to the appliance. To replace knobs after cleaning, line up the flat sides of both the knob and the shaft; then push the knob into place.
Porcelain Enamel Burner Grates, Cooktop Surface, Below Cooktop, Broiler Pan & Insert (some models), Door Liner, Oven Bottom & Burner Drip Pans	Clean burner grates, broiler pan and insert (some models) in the dishwasher and dry upon removal. If soils are not removed, follow the cooktop cleaning instructions below.  Gentle scouring with a soapy scouring pad will remove most spots. Rinse with a 1:1 solution of clear water and ammonia. If necessary, cover difficult spots with an ammonia-soaked paper towel for 30 to 40 minutes. Rinse with clean water and a damp cloth, then scrub with a soap-filled scouring pad. Rinse and wipe dry with a clean cloth. Remove all cleaners or the porcelain may become damaged during future heating. DO NOT use spray oven cleaners on the cooktop.
Easy Care™ Stainless Steel (some models) Oven Door & Drawer Front Panel and Decorative Trim	Your range finish is may be made with Easy Care™ Stainless Steel (some models). Clean the stainless with warm soapy water using a clean sponge or cloth. Rinse with clean water and dry with a soft clean cloth. DO NOT use ANY store bought cleaners like Stainless Steel cleaners or any other types of cleaners containing any abrasive, chlorides, chlorines or ammonia. It is recommended to use mild dish soap and water or a 50/50 solution of water and vinegar.
Oven Racks 	Remove racks. See "To remove and to replace an oven rack" under Oven vent(s) and racks. Use a mild, abrasive cleaner, following manufacturer's instructions. Rinse with clean water and dry. After cleaning the racks, rub the sides of the racks with wax paper or a cloth containing a small amount of baby oil or salad oil (this will make the racks glide easier into the rack positions).
Oven Door 	Use soap & water to thoroughly clean the top, sides and front of the oven door. Rinse well. You may use a glass cleaner on the outside glass of the oven door. DO NOT immerse the door in water. DO NOT spray or allow water or the glass cleaner to enter the door vents. DO NOT use oven cleaners, cleaning powders or any harsh abrasive cleaning materials on the outside of the oven door.  DO NOT clean the oven door gasket. The oven door gasket is made of a woven material, on Self-Cleaning models, which is essential for a good seal. Care should be taken not to rub, damage or remove this gasket.

## CARE & CLEANING

### Cleaning the cooktop, burner caps & grates

The cooktop is designed to make cleaning easier. Because the gas Burners are sealed, cleanups are easy when spillovers are cleaned up immediately.

The cooktop, Burner Heads and Caps should be routinely cleaned. Keeping the Burner Head Ports clean will prevent improper ignition and an uneven flame. Refer to the following instructions:

#### IMPORTANT

**THE COOKTOP IS NOT REMOVABLE.** Do not attempt to remove or lift the cooktop.

#### CAUTION

Pay attention to not damage electrodes. Damaged electrodes may cause a delayed ignition or prevent the burner from igniting.

#### CAUTION

Any additions, changes or conversions required in order for this appliance to perform satisfactorily must be made by an authorized Service Center.

**Do not remove any parts from the cooktop until they have completely cooled and are safe to handle. Do not operate the surface Burners without the Burner Caps and Burner Heads properly in place.**

**To Clean the surface Burner Caps and Burner Heads-** Use a soap-filled scouring pad or a mild abrasive cleanser to clean the surface Burner Caps. The ports (or slots) around the Burner Heads must be routinely checked. If residue remains in these ports (or slots), use a small-gauge wire or needle to clean the slots or holes. For proper flow of gas and ignition of the burner—**DO NOT ALLOW SPILLS, FOOD, CLEANING AGENTS OR ANY OTHER MATERIAL TO ENTER THE GAS ORIFICE HOLDER OPENING. ALWAYS** keep the surface Burner Caps in place whenever the gas Burners are in use or not.

**To Clean the Burner Grates- Be sure burners and grates are cool** before you place your hand, a pot holder, cleaning cloths or other material on them. The cast iron burner grates can be washed in hot soapy water. Rinse thoroughly and dry the grates with a cloth - don't put them on the cooktop while still wet. Be sure the grates are positioned securely over the burners.

To remove burned on food, place the grates in a covered container or plastic bag. Add 1/4 cup ammonia and soak for 30 minutes. Wash, rinse well and dry. An abrasive cleaner can be used for stubborn stains.

**To Clean the Cooktop and contoured areas of the cooktop-** If a spill occurs on the porcelain cooktop, blot up spill with an absorbent cloth. Rinse with a clean, damp cloth and wipe dry. Do not use harsh abrasive cleaners on the cooktop. They can scratch the porcelain. Completely rinse any mild cleaners used from the surface or the porcelain cooktop may become damaged during future heating. DO NOT use spray oven cleaners on the cooktop.

### Care and cleaning of stainless steel (Stainless Steel models only)

Some models are equipped with stainless steel exterior parts. Special care and cleaning are **required** for maintaining the appearance of stainless parts. Please refer to the table provided at the beginning of the **General Care & Cleaning** section in this Use & Care Guide.

## Removing and replacing the lift-off oven door

### CAUTION

The door is heavy. For safe, temporary storage, lay the door flat with the inside of the door facing down.

#### To Remove Oven Door:

1. Open oven door completely (horizontal with floor - See Figure 1) and remove connector arms (Effortless rack) from door (See page 12).
2. Pull the door hinge locks on both left and right door hinges down from the oven frame completely towards the oven door (See Figure 2). A tool such as a small flat-blade screwdriver may be required.
3. Firmly grasp both sides of oven door along the door sides (Do not use the oven door handle - See Figure 3).
4. Close the door to the broil stop position (the oven door will stop into this position just before fully closing).
5. With the oven door in the broil stop position, lift the oven door hinge arms over the roller pins located on each side of the oven frame (See Figure 4).

#### To Replace Oven Door:

1. Firmly grasp both sides of oven door along the door sides (Do not use the oven door handle - See Figure 3).
2. Holding the oven door at the same angle as the removal position, seat the hook of the hinge arm over the roller pins located on each side of the oven door frame (See Figure 4). The hook of the hinge arms must be fully seated onto the roller pins.
3. Fully open the oven door (horizontal with floor - See Figure 1).
4. Push the door hinge locks up towards and into the oven frame on both left and right oven door hinges (See Figure 2) to the locked position.
5. Close the oven door and reconnect connector arms (Effortless rack) from door (See page 12).

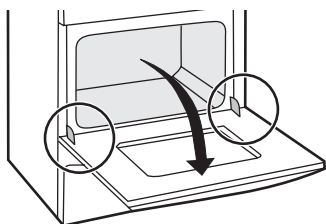

Door Hinge locations with oven door fully open

Figure 1

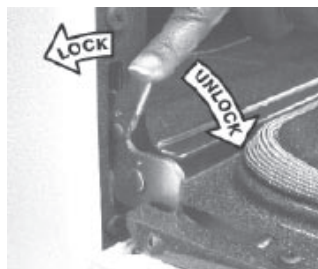

Figure 2

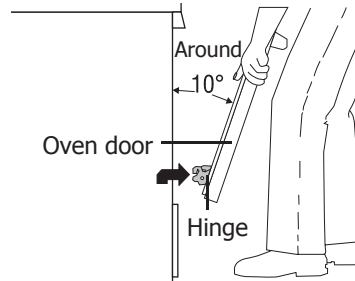

Figure 3

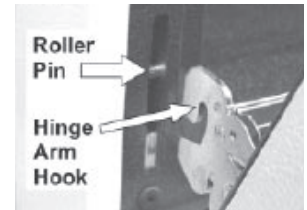

Figure 4

### Special door care instructions - Most oven doors contain glass that can break.

Read the following recommendations:

1. Do not close the oven door until all the oven racks are fully in place.
2. Do not hit the glass with pots, pans, or any other object.
3. Scratching, hitting, jarring or stressing the glass may weaken its structure causing an increased risk of breakage at a later time.

## Changing oven light

### CAUTION

Be sure the oven is unplugged and all parts are COOL before replacing the oven light bulb. Do not turn the oven light on during a self-cleaning cycle. High temperature will reduce lamp life.

On some models an interior oven light will turn on automatically when the oven is opened. The oven light may be turned on when the door is closed by using the oven light switch located on the Electronic Oven control. The oven light bulb is covered with a glass shield held in place by a wire holder. THIS GLASS SHIELD MUST ALWAYS BE IN PLACE WHEN THE OVEN IS IN USE.

### CAUTION

**BE SURE OVEN IS COOL**

#### To Replace the Light Bulb:

1. Turn the power off at the main source.
2. Wear a leather-faced glove for protection against possible broken glass.
3. Replace bulb with a 40 Watt appliance bulb only.
4. For self-cleaning oven, press wire holder to one side to release glass shield, change bulb and be sure to replace glass shield.



## CARE & CLEANING

### To remove and replace keep warm drawer

#### **WARNING**

Turn power off before removing the warmer drawer.

#### To remove keep warmer drawer

1. Open the drawer to the fully opened position.
2. Locate the latches on both sides of the keep warm drawer.
3. Pull up on the left glide latch and push down on the right glide latch.
4. Pull the drawer away from the appliance.
5. To clean keep warm drawer, gently scour with a soapy scouring pad, this will remove most spots. Rinse with a 1:1 solution of clear water and ammonia. If necessary, cover difficult spots with an ammonia-soaked paper towel for 30 to 40 minutes. Rinse with clean water and a damp cloth. Remove all cleaners or the porcelain may become damaged during future heating. **DO NOT** use spray oven cleaners on the cooktop.

#### To replace keep warm drawer

1. Align the glide latches on both sides of the drawer with the slots on the drawer.
2. Push the drawer back into the appliance.

#### **WARNING**

Turn the keep warm drawer control knob to OFF before removing the drawer. **DO NOT** touch the keep warm drawer element. The element may still be hot enough to cause burns, even if it is dark in color.

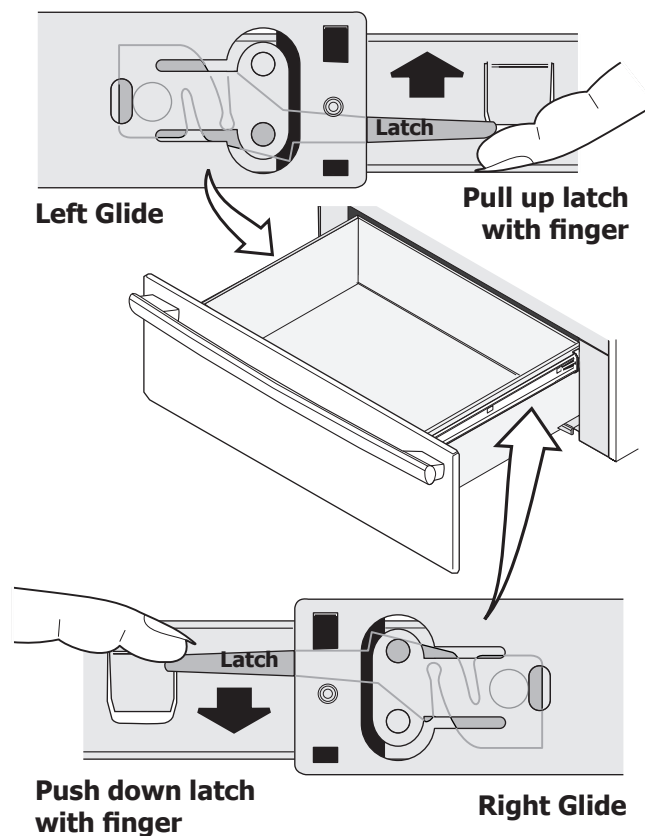

#### **WARNING**



**Electrical Shock Hazard** can occur and result in serious injury or death. Disconnect appliance from electric power before cleaning and servicing the keep warm drawer.







## BEFORE YOU CALL (Solutions to Common Problems)

### Oven baking

For best cooking results, heat the oven before baking cookies, breads, cakes, pies or pastries, etc. There is no need to preheat the oven for roasting meat or baking casseroles.

The cooking times and temperatures needed to bake a product may vary slightly from your previously owned appliance.

**Baking Problems and Solutions Chart**

Baking Problems	Causes	Corrections
<p><b>Cookies and biscuits burn on the bottom.</b></p> 	<ul style="list-style-type: none"> <li>• Cookies and biscuits put into the oven before the preheating time is completed.</li> <li>• Oven rack overcrowded.</li> <li>• Dark pan absorbs heat too fast.</li> </ul>	<ul style="list-style-type: none"> <li>• Allow oven to preheat to the selected temperature before placing food in oven.</li> <li>• Choose pan sizes that will permit 5.1cm to 10.2cm (2" to 4") of air space on all sides when placed in the oven.</li> <li>• Use a medium-weight aluminum baking sheet.</li> </ul>
<p><b>Cakes too dark on top or bottom.</b></p> 	<ul style="list-style-type: none"> <li>• Cakes put into the oven before preheating time is completed.</li> <li>• Rack position too high or low.</li> <li>• Oven too hot.</li> </ul>	<ul style="list-style-type: none"> <li>• Allow oven to preheat to the selected temperature before placing food in the oven.</li> <li>• Use proper rack position for baking needs.</li> <li>• Set oven temperature 25°F/12°C lower than recommended.</li> </ul>
<p><b>Cakes not done in the center.</b></p> 	<ul style="list-style-type: none"> <li>• Oven too hot.</li> <li>• Incorrect pan size.</li> <li>• Pan not centered in oven.</li> </ul>	<ul style="list-style-type: none"> <li>• Set oven temperature 25°F/12°C lower than recommended.</li> <li>• Use pan size suggested in recipe.</li> <li>• Use proper rack position and place pan so there is 5.1cm to 10.2cm (2" to 4") of space on all sides of pan.</li> </ul>
<p><b>Cakes not level.</b></p> 	<ul style="list-style-type: none"> <li>• Range not level.</li> <li>• Pan too close to oven wall or rack overcrowded.</li> <li>• Pan warped.</li> </ul>	<ul style="list-style-type: none"> <li>• Place a marked glass measuring cup filled with water on the center of the oven rack. If the water level is uneven, refer to the installation instructions for leveling the range.</li> <li>• Be sure to allow 5.1cm to 10.2cm (2" to 4") of clearance on all sides of each pan in the oven.</li> <li>• Do not use pans that are dented or warped.</li> </ul>
<p><b>Foods not done when cooking time is up.</b></p> 	<ul style="list-style-type: none"> <li>• Oven too cool.</li> <li>• Oven overcrowded.</li> <li>• Oven door opened too frequently.</li> </ul>	<ul style="list-style-type: none"> <li>• Set oven temperature 25°F/12°C higher than suggested and bake for the recommended time.</li> <li>• Be sure to remove all pans from the oven except the ones to be used for baking.</li> <li>• Open oven door only after shortest recommended baking time.</li> </ul>

## BEFORE YOU CALL (Solutions to Common Problems)

### IMPORTANT

**Before you call for service,** review this list. It may save you time and expense. The list includes common occurrences that are not the result of defective workmanship or materials in this appliance.

OCCURRENCE	POSSIBLE CAUSE/SOLUTION
<b>Range is not level.</b>	<p>Poor installation. Place oven rack in center of oven. Place a level on the oven rack. Adjust leveling legs at base of range until the rack is level. When range is level, cooktop may appear out of alignment if countertop is not level.</p> <p>Weak, unstable floor. Be sure floor is level and can adequately support range. If floor is sagging or slopping, contact a carpenter to correct the situation.</p> <p>Kitchen cabinet misalignment may make range appear to be unlevel. Be sure cabinets are square and have sufficient room for range clearance.</p>
<b>Cannot move appliance easily. Appliance must be accessible for service.</b>	<p>Cabinets not square or are built in too tight. Contact a cabinet maker to correct the problem.</p> <p>Contact builder or installer to make appliance accessible.</p> <p>Carpet interferes with range. Provide sufficient space so range can be lifted over carpet.</p> <p>Gas line is hard-plumbed. Have a flexible C.S.A international approved metal appliance connector installed.</p>
<b>Entire range or oven does not operate.</b>	<p>Make sure cord/plug is plugged tightly into outlet.</p> <p>Service wiring is not complete. Call an authorized servicer.</p> <p>Electrical power outage. Check house lights to be sure. Call your local electric company for service.</p>
<b>Oven control beeps and displays any F code error (ex.: F11)</b>	<p>Electronic control has detected a fault condition. Press <b>Cancel</b> to clear the display and stop beeping. Reprogram oven. If fault recurs, record fault number. Press <b>Cancel</b> and call an authorized servicer for assistance.</p>
<b>Oven light does not work.</b>	<p>Replace or tighten bulb. See Changing Oven Light section in this Use &amp; Care Guide.</p> <p>Electrical power outage. Check house lights to be sure. Call your local electric company for service.</p>
<b>Surface burners do not light.</b>	<p>Surface Control knob has not been completely turned to LITE. Push in and turn the Surface Control knob to LITE until burner ignites and then turn control to desired flame size.</p> <p>Be sure gas supply valve is open.</p> <p>Burner ports or slots are clogged. With the burner off, use a small-gauge wire or needle to clean ports or slots.</p> <p>Power cord is disconnected from outlet (electric ignition models). Be sure cord is plugged securely into outlet.</p> <p>Electrical power outage (electric ignition models). Burners can be lit manually. See Setting Surface Controls in this Owner's Guide.</p>
<b>Surface burner flame burns half way around.</b>	<p>Burner ports or slots are clogged. With the burner off, clean ports with a small-gauge wire or needle to clean ports or slots.</p> <p>Moisture is present after cleaning. Lightly fan the flame and allow burner to operate until flame is full. Dry the burners thoroughly following instructions under General Cleaning.</p>
<b>Surface burner flame is orange.</b>	<p>Dust particles in main line. Allow the burner to operate a few minutes until flame turns blue.</p> <p>In coastal areas, a slightly orange flame is unavoidable due to salt air.</p>
<b>Poor baking results.</b>	<p>Many factors affect baking results. Make sure the proper rack position is used. Center food in the oven and space pans to allow air to circulate. Allow the oven to preheat to the set temperature before placing food in the oven. Try adjusting the recipes' recommended temperature or baking time. If you feel the oven is too hot or cool, see "Adjusting Your Oven Temperature" section in the Electronic Oven Control Guide.</p>
<b>Fan noise during cooking operation.</b>	<p>A cooling fan may automatically turn on and off to cool internal parts. It is normal, and the fan may continue to run even after oven is turned off.</p>



## BEFORE YOU CALL (Solutions to Common Problems)

OCCURRENCE	POSSIBLE CAUSE/SOLUTION
<b>Flames inside oven or smoking from vent.</b>	Excessive spillovers in oven. Set self-clean cycle for a longer cleaning time.
	Excessive spillovers in oven. This is normal, especially for pie spillovers or large amounts of grease on the oven bottom. Wipe up excessive spillovers before starting the self-clean cycle. If flames or excessive smoke are present, stop the self-clean cycle and follow the steps under "Stopping or Interrupting the Self-Cleaning Cycle" in the Electronic Oven Control Guide.
<b>Oven smokes excessively during broiling.</b>	Control(s) not set properly. Follow instructions under "Setting Oven Controls".
	Make sure oven is opened to Broil Stop Position.
	Meat too close to the element. Reposition the rack to provide proper clearance between the meat and the element. Preheat broil element. Preheat broil element for searing.
	Grid on broiler pan wrong side up and grease not draining. Always place grid on the broiler pan with ribs up and slots down to allow grease to drip into pan.
	Grease has built up on oven surfaces. Regular cleaning is necessary when broiling frequently. Old grease or food spatters cause excessive smoking.
Control(s) not set properly. Follow instructions under "Oven Cleaning" in the Electronic Oven Control Guide.	
<b>Self-cleaning cycle does not work.</b>	Control(s) not set properly. Follow instructions under "Oven Cleaning" in the Electronic Oven Control Guide.
	Self-cleaning cycle was interrupted. Stop time must be 2 to 4 hours past the start time. Follow steps under "Stopping or Interrupting the Self-Cleaning Cycle" in the Electronic Oven Control Guide.
<b>Soil not completely removed after self-cleaning cycle.</b>	Set Self-Clean cycle for a longer cleaning time.
	Failure to clean bottom front, top of oven or door areas outside oven seal. These areas are not in the Self-Cleaning area, but get hot enough to burn on food residue. Clean these areas before starting the Self-Clean cycle. Burned-on residue may be cleaned with a stiff nylon brush and water or nylon scrubber. Be careful not to damage the oven gasket.

### AVOID TRANSPORTATION DAMAGE TO YOUR RANGE

If you have to move your range into/out or your residence or when moving to a new home, it is suggested that you take the following precautions:

1. Screw in the levelling legs under the range.
2. Remove the racks and other utensils from the oven, and from the lower drawer.
3. Use adhesive tape to firmly secure the door and the drawer to the side panels. Also attach the electric power cord in the same manner.
4. Use a two-wheeled trolley with strap and fasten the range to it. Cover the appliance with a heavy blanket to prevent scratches and dents.
5. Avoid pulling or pushing on the control panel when moving the appliance.

## MAJOR APPLIANCE WARRANTY

Your appliance is covered by a one year limited warranty. For one year from your original date of purchase, Electrolux will pay all costs for repairing or replacing any parts of this appliance that prove to be defective in materials or workmanship when such appliance is installed, used and maintained in accordance with the provided instructions.

**Exclusions This warranty does not cover the following:**

1. Products with original serial numbers that have been removed, altered or cannot be readily determined.
2. Product that has been transferred from its original owner to another party or removed outside the USA or Canada.
3. Rust on the interior or exterior of the unit.
4. Products purchased "as-is" are not covered by this warranty.
5. Food loss due to any refrigerator or freezer failures.
6. Products used in a commercial setting.
7. Service calls which do not involve malfunction or defects in materials or workmanship, or for appliances not in ordinary household use or used other than in accordance with the provided instructions.
8. Service calls to correct the installation of your appliance or to instruct you how to use your appliance.
9. Expenses for making the appliance accessible for servicing, such as removal of trim, cupboards, shelves, etc., which are not a part of the appliance when it is shipped from the factory.
10. Service calls to repair or replace appliance light bulbs, air filters, water filters, other consumable, or knobs, handles, or other cosmetic parts.
11. Surcharges including, but not limited to, any after hour, weekend, or holiday service calls, tolls, ferry trip charges, or mileage expense for service calls to remote areas, including the state of Alaska.
12. Damages to the finish of appliance or home incurred during installation, including but not limited to floors, cabinets, walls, etc.
13. Damages caused by: services performed by unauthorized service companies; use of parts other than genuine Electrolux parts or parts obtained from persons other than authorized service companies; or external causes such as abuse, misuse, inadequate power supply, accidents, fires, or acts of God.

**DISCLAIMER OF IMPLIED WARRANTIES; LIMITATION OF REMEDIES**

Customer's sole and exclusive remedy under this limited warranty shall be product repair or replacement as provided herein. Claims based on implied warranties, including warranties of merchantability or fitness for particular purpose, are limited to one year or the shortest period allowed by law, but not less than one year. Electrolux shall not be liable for consequential or incidental damages such as property damage and incidental expenses resulting from any breach of this written limited warranty or any implied warranty. Some states and provinces do not allow the exclusion or limitation of incidental or consequential damages, or limitations on the duration of implied warranties, so these limitations or exclusions may not apply to you. This written warranty gives you specific legal rights. You may also have other rights that vary from state to state.

**If You  
Need  
Service**

Keep your receipt, delivery slip, or some other appropriate payment record to establish the warranty period should service be required. If service is performed, it is in your best interest to obtain and keep all receipts. Service under this warranty must be obtained contacting Electrolux at the addresses or phone numbers below.

This warranty only applies in the USA and Canada. In the USA, your appliance is warranted by Electrolux Major Appliances North America, a division of Electrolux Home Products, Inc. In Canada, your appliance is warranted by Electrolux Canada Corp. Electrolux authorizes no person to change or add to any obligations under this warranty. Obligations for service and parts under this warranty must be performed by Electrolux or an authorized service company. Product features or specifications as described or illustrated are subject to change without notice.

**USA**  
**1.800.944.9044**  
**Electrolux Home Products, Inc.,**  
**10200 David Taylor Drive**  
**Charlotte, NC 28262**



**Canada**  
**1.800.265.8352**  
**Electrolux Canada Corp.**  
**5855 Terry Fox Way**  
**Mississauga, Ontario, Canada**  
**L5V 3E4**