

Model
KCMS135

USE & CARE GUIDE

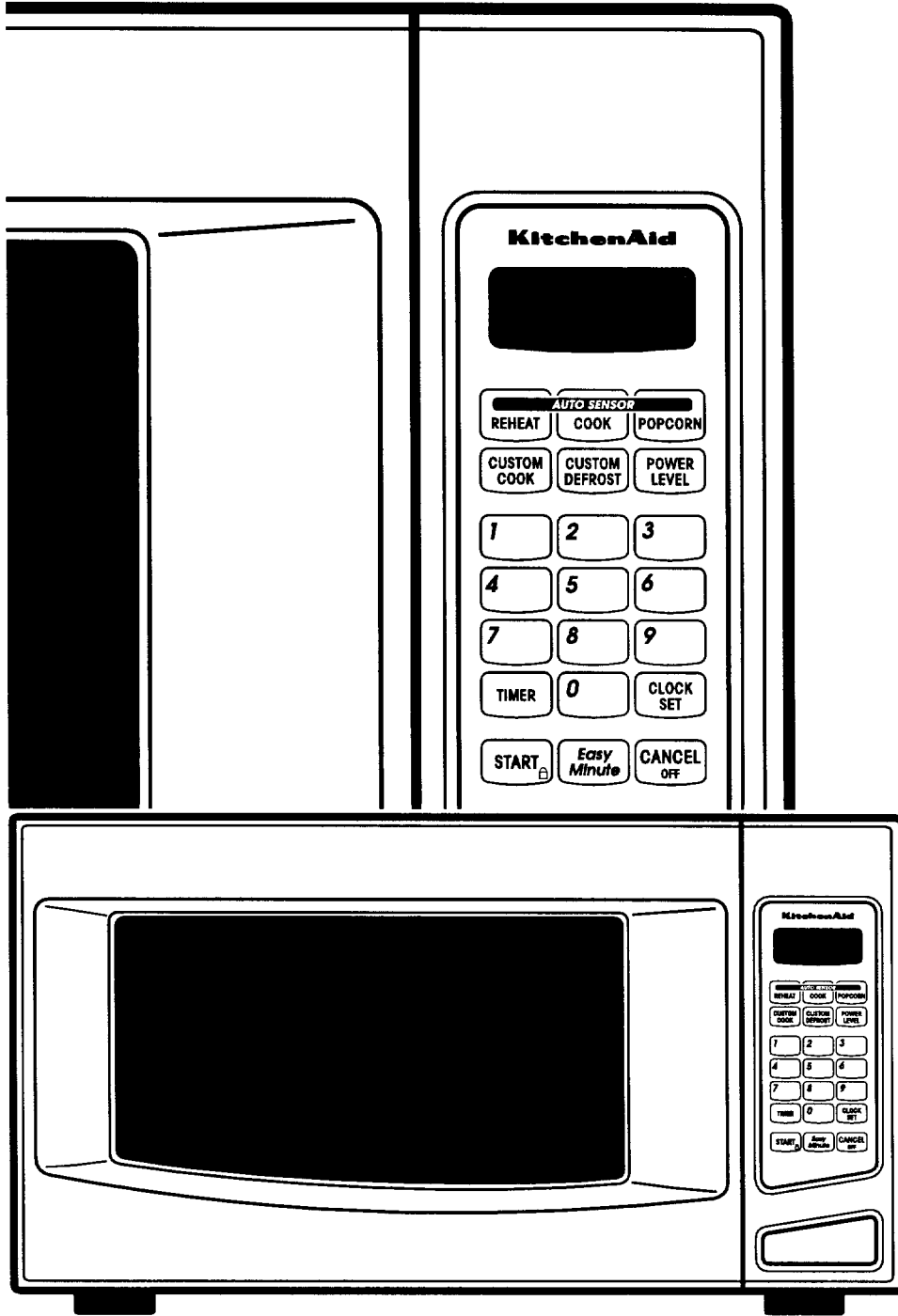

KitchenAid

Microwave Oven

A Note to You	2
Microwave Oven Safety	3-4
Installation Instructions	5
Getting to Know Your Microwave Oven	7
Standard Microwave Cooking	18
Auto Sensor Cooking ...	27
Caring for Your Microwave Oven	30
Cooking Guide	31
Questions and Answers	39
Troubleshooting	40
Requesting Assistance or Service	42
Index	43
Warranty	44

1-800-422-1230

Call us with questions
or comments.

PART NO. 3828W5A0618/4359627

5-98

A NOTE TO YOU

Thank you for buying a KITCHENAID® appliance!

KitchenAid designs the best tools for the most important room in your house. To ensure that you enjoy many years of trouble-free operation, we developed this Use and Care Guide. It contains valuable information concerning how to operate and maintain your new appliance properly and safely. Please read it carefully.

Also, please complete and mail the enclosed Product Registration Card.

For assistance or service

Call the Consumer Assistance Center toll free **1-800-422-1230**

If you need assistance or service, first see the "Troubleshooting" section of this book. After checking "Troubleshooting," additional help can be found by checking the "Requesting Assistance or Service" section, or by calling the telephone number above.

When calling, you will need to know your appliance's complete model number and serial number. You can find this information on the model and serial number label/plate (see diagram in the "Getting to Know" section.)

Keep this book and the sales slip together in a safe place for future reference. **You must provide proof of purchase or installation date for in-warranty service.**

Model Number _____	Builder/Dealer Name _____
Serial Number _____	Address _____
Date Installed _____	Phone _____

MICROWAVE OVEN SAFETY

Your safety and the safety of others is very important.

We have provided many important safety messages in this manual and on your appliance. Always read and obey all safety messages.



This is the safety alert symbol.

This symbol alerts you to hazards that can kill or hurt you and others.

All safety messages will be preceded by the safety alert symbol and the word "DANGER" or "WARNING." These words mean:

! DANGER

You will be killed or seriously injured if you don't follow instructions.

! WARNING

You can be killed or seriously injured if you don't follow instructions.

All safety messages will identify the hazard, tell you how to reduce the chance of injury, and tell you what can happen if the instructions are not followed.

IMPORTANT SAFETY INSTRUCTIONS

When using electrical appliances basic safety precautions should be followed, including the following:

WARNING – To reduce the risk of burns, electric shock, fire, injury to persons or exposure to excessive microwave energy:

- Read all instructions before using the microwave oven.
- Read and follow the specific "PRECAUTIONS TO AVOID POSSIBLE EXPOSURE TO EXCESSIVE MICROWAVE ENERGY" found in this section.
- The microwave oven must be grounded. Connect only to properly grounded outlet. See "GROUNDING INSTRUCTIONS" found in the "Installation Instructions" section.
- Install or locate the microwave oven only in accordance with the installation instructions.
- Some products such as whole eggs and sealed containers – for example, closed glass jars – may explode and should not be heated in the microwave oven.
- Use the microwave oven only for its intended use as described in this manual. Do not use corrosive chemicals or vapors in the microwave oven. This type of oven is specifically designed to heat, cook, or dry food. It is not designed for industrial or laboratory use.
- As with any appliance, close supervision is necessary when used by children.
- Do not operate the microwave oven if it has a damaged cord or plug, if it is not working properly, or if it has been damaged or dropped.
- The microwave oven should be serviced only by qualified service personnel. Call an authorized service company for examination, repair or adjustment.
- Do not cover or block any openings on the microwave oven.
- Do not store the microwave oven outdoors. Do not use the microwave oven near water – for example, near a kitchen sink, in a wet basement, or near a swimming pool, and the like.
- Do not immerse cord or plug in water.
- Keep cord away from heated surfaces.
- Do not let cord hang over edge of table or counter.
- See door surface cleaning instructions in the "Caring for Your Microwave Oven" section.

– SAVE THESE INSTRUCTIONS –

continued on next page

MICROWAVE OVEN SAFETY

IMPORTANT SAFETY INSTRUCTIONS

- Do not mount over a sink.
- Do not store anything directly on top of the microwave oven surface when the microwave oven is in operation.
- To reduce the risk of fire in the oven cavity:
 - Do not overcook food. Carefully attend the microwave oven if paper, plastic, or other combustible materials are placed inside the oven to facilitate cooking.
 - Remove wire twist-ties from paper or plastic bags before placing bag in oven.
 - If materials inside the oven should ignite, keep oven door closed, turn oven off, and disconnect the power cord, or shut off power at the fuse or circuit breaker panel.
 - Do not use the cavity for storage purposes. Do not leave paper products, cooking utensils, or food in the cavity when not in use.

– SAVE THESE INSTRUCTIONS –

PRECAUTIONS TO AVOID POSSIBLE EXPOSURE TO EXCESSIVE MICROWAVE ENERGY

- (a)** Do not attempt to operate this oven with the door open since open-door operation can result in harmful exposure to microwave energy. It is important not to defeat or tamper with the safety interlocks.
- (b)** Do not place any object between the oven front face and the door or allow soil or cleaner residue to accumulate on sealing surfaces.
- (c)** Do not operate the oven if it is damaged. It is particularly important that the oven door close properly and that there is no damage to the:
 - (1) door (bent),
 - (2) hinges and latches (broken or loosened),
 - (3) door seals and sealing surfaces.
- (d)** The oven should not be adjusted or repaired by anyone except properly qualified service personnel.

INSTALLATION INSTRUCTIONS

Before you begin operating the oven, carefully read the following instructions.

- 1. Empty** the microwave oven and **clean** inside it with a soft, damp cloth. **Check** for damage such as a door that isn't lined up correctly, damage around the door, or dents inside the oven or on the exterior. If there is any damage, do not operate the oven until an authorized service technician has checked it and made any needed repairs.

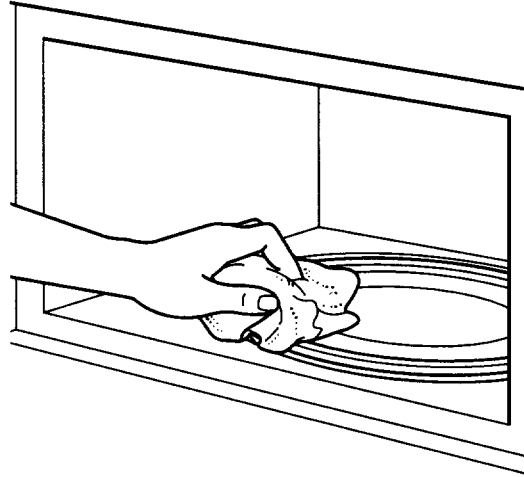

- 2. Put** the oven on a cart, counter, table, or shelf that is strong enough to hold the oven and the food and cookware you put in it. **(The control side of the unit is the heavy side. Use care when handling the oven.)** The microwave oven should be at a temperature above 50°F for proper operation.

NOTE: You can build your microwave oven into a wall or cabinet by using one of the trim kits listed in "Built-in kits" in the "Getting to Know" section.

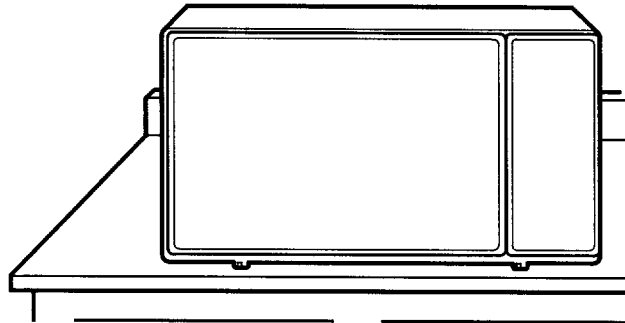

⚠ WARNING



Fire Hazard

Do not install the oven next to or over a heat source without a UL approved trim kit.

Doing so can result in death, fire, or electrical shock.

NOTE: Do not block the exhaust vents or rear air intake openings. Allow a few inches of space at the back of the oven where the intake openings are located. Blocking the air intake openings and exhaust vents could cause damage to the oven and poor cooking results. Make sure the microwave oven legs are in place to ensure proper airflow. If vents are blocked, a sensitive thermal safety device automatically turns the oven off. The oven will not work until it has cooled enough.

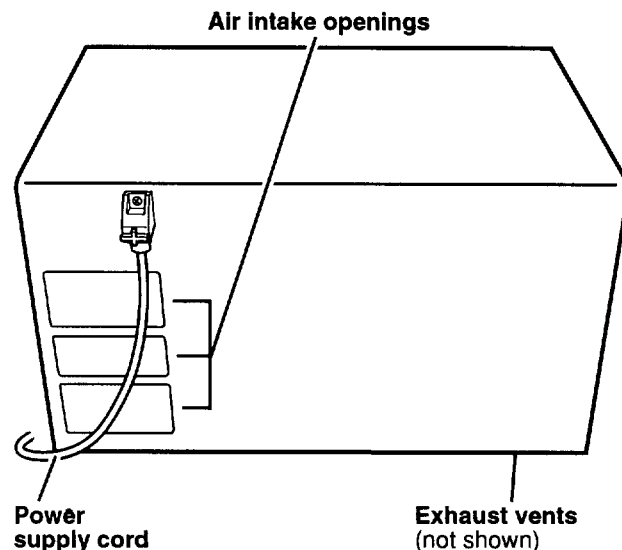

INSTALLATION INSTRUCTIONS

Electrical requirements

Observe all governing codes and ordinances. A 120 Volt, 60 Hz, AC only, 15 or 20 amp fused electrical supply is required. (A time-delay fuse is recommended.) It is recommended that a separate circuit serving only this appliance be provided.

⚠ WARNING



Electrical Shock Hazard

Plug into a grounded 3 prong outlet.

Do not remove ground prong.

Do not use an adapter.

Do not use an extension cord.

Failure to follow these instructions can result in death, fire, or electrical shock.

GROUNDING INSTRUCTIONS

For all cord connected appliances:

The microwave oven must be grounded. In the event of an electrical short circuit, grounding reduces the risk of electric shock by providing an escape wire for the electric current. The microwave oven is equipped with a cord having a grounding wire with a grounding plug. The plug must be plugged into an outlet that is properly installed and grounded.

WARNING – Improper use of the grounding can result in a risk of electric shock.

Consult a qualified electrician or serviceman if the grounding instructions are not completely understood, or if doubt exists as to whether the microwave oven is properly grounded.

Do not use an extension cord. If the power supply cord is too short, have a qualified electrician or serviceman install an outlet near the microwave oven.

For a permanently connected appliance:

The microwave oven must be connected to a grounded, metallic, permanent wiring system, or an equipment grounding conductor should be run with the circuit conductors and connected to the equipment grounding terminal or lead on the microwave oven.

GETTING TO KNOW YOUR MICROWAVE OVEN

This section discusses the concepts behind microwave cooking. It also shows you the basics you need to know to operate your microwave oven. Please read this information before you use your oven.

How your microwave oven works

Microwave ovens are safe. Microwave energy is not hot. It causes food to make its own heat, and it's this heat that cooks the food.

Microwaves are like TV waves or light waves. You cannot see them, but you can see what they do.

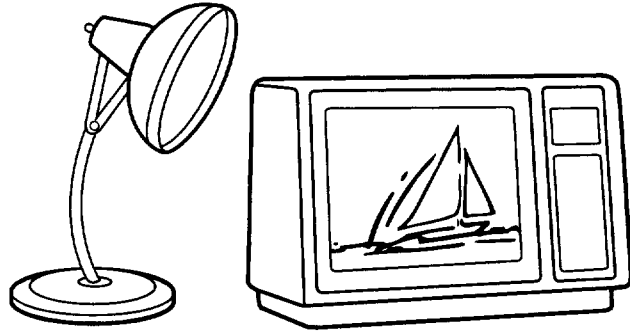

A magnetron in the microwave oven produces microwaves. The microwaves move into the oven where they contact food as it turns on the turntable.

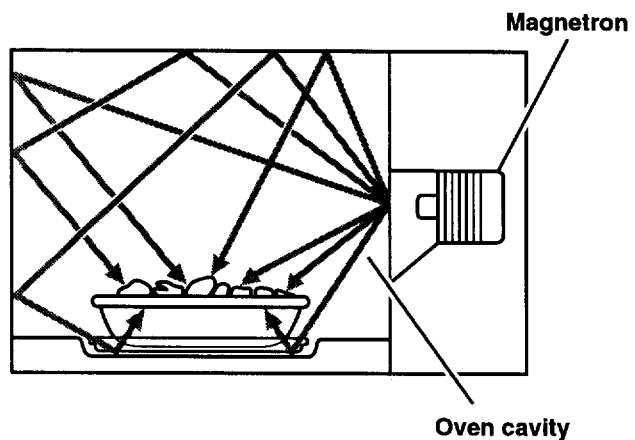

The glass turntable of your microwave oven lets microwaves pass through. Then they bounce off a metal floor, back through the glass turntable, and are absorbed by the food.

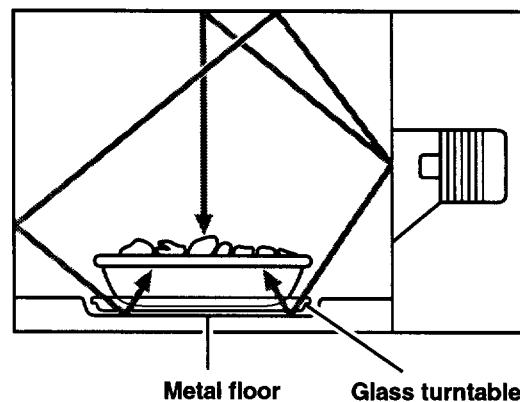

continued on next page

GETTING TO KNOW YOUR MICROWAVE OVEN

How your microwave oven works (cont.)

Microwaves pass through most glass, paper, and plastics without heating them so food absorbs the energy. Microwaves bounce off metal containers so food does not absorb the energy.

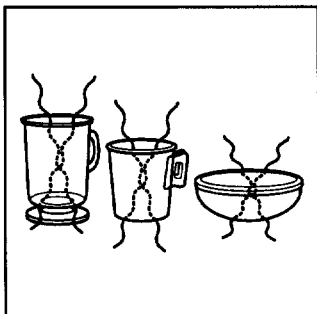

The microwaves disturb water molecules in the food. As the molecules bounce around bumping into each other, heat is made, like rubbing your hands together. This is the heat that does the cooking.

NOTE: Do not deep fry in the oven. Microwavable cookware is not suitable and it is difficult to maintain appropriate deep-frying temperatures.

Microwaves may not reach the center of a roast.

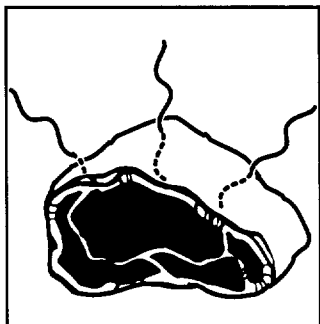

The heat spreads to the center from the outer, cooked areas just as in regular oven cooking. This is one of the reasons for letting some foods (for example, roasts or baked potatoes) stand for a while after cooking, or for stirring some foods during the cooking time.

For the best cooking results

- Always cook food for the shortest cooking time recommended. Check to see how the food is cooking. If needed, touch EASY MINUTE while the oven is operating or after the cooking cycle is over (see "Using EASY MINUTE" later in this section).
- To help make sure the food is evenly cooked, stir, turn over, or rearrange the food being cooked about halfway through the cooking time for all recipes.
- If you do not have a cover for a dish, use wax paper, or microwave-approved paper towels or plastic wrap. Remember to turn back a corner of the plastic wrap to vent steam during cooking.

GETTING TO KNOW YOUR MICROWAVE OVEN

Radio interference

Using your microwave oven may cause interference to your radio, TV, or similar equipment. When there is interference, you can reduce it or remove it by:

- Cleaning the door and sealing surfaces of the oven.
- Adjusting the receiving antenna of the radio or television.
- Moving the radio or TV away from the microwave oven.
- Plugging the microwave oven into a different outlet so that the microwave oven and radio or TV are on different branch circuits.

Testing your microwave oven

To test the oven, put about 1 cup of cold water in a glass container in the oven. Close the door and make sure it latches. Follow the directions in "Cooking at high cook power" in the "Standard Microwave Cooking" section to set the oven to cook for 2 minutes. When the time is up, the water should be heated.



Testing your dinnerware or cookware

Test dinnerware or cookware before using.

To test a dish for safe use, put it into the oven with a cup of water beside it. Cook at 100% cook power for 1 minute. **If the dish gets hot and water stays cool, do not use it.** Some dishes (melamine, some ceramic dinnerware, etc.) absorb microwave energy, becoming too hot to handle and slowing cooking times. Cooking in metal containers not designed for microwave use could damage the oven, as could containers with hidden metal (twist-ties, foil lining, staples, metallic glaze or trim).

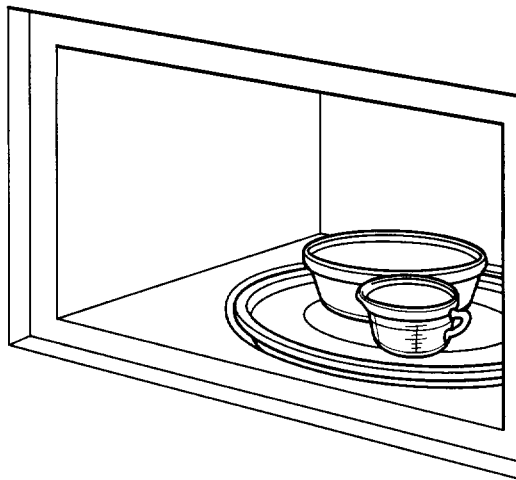

GETTING TO KNOW YOUR MICROWAVE OVEN

Operating safety precautions

Never cook or reheat a whole egg inside the

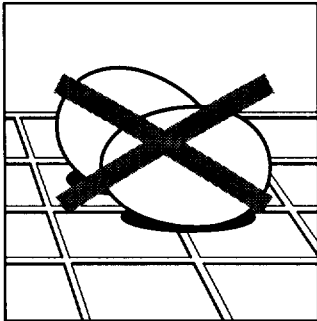

shell. Steam buildup in whole eggs may cause them to burst and burn you, and possibly damage the oven. **Slice** hard-boiled eggs before heating. In rare cases, poached eggs have been known to explode. **Cover** poached eggs and **allow** a standing

time of 1 minute before cutting into them.

For best results, stir any liquid several times during heating or reheating.

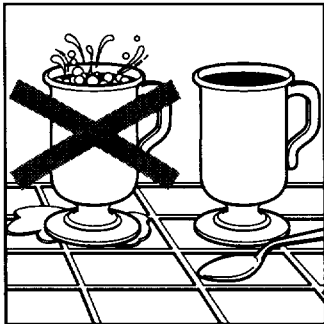

Liquids heated in certain containers (especially containers shaped like cylinders) may become overheated. The liquid may splash out with a loud noise during or after heating or when adding ingredients

(coffee granules, tea bags, etc.). This can harm the oven and possibly injure someone.

Never lean on the door or allow a child to swing on it when the door is open. Injury could result.

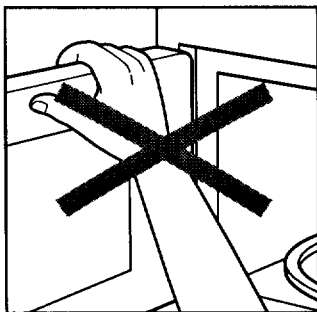

Use hot pads. Microwave energy does not heat

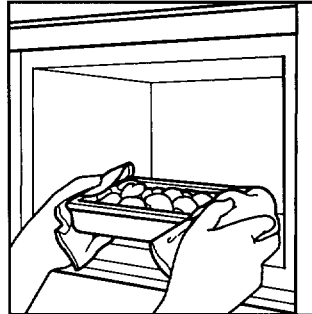

containers, but the heat from the food can make the container hot.

Do not overcook potatoes. Fire could result. At

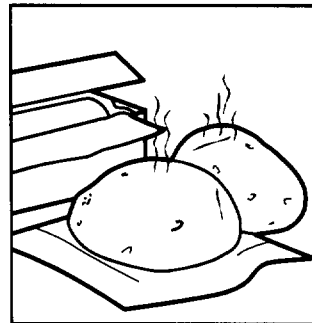

the end of the recommended cooking time, potatoes should be slightly firm because they will continue cooking during standing time. **After microwaving,** let potatoes stand for 5 minutes. They will finish cooking while standing.

Do not start a microwave oven when it is empty.

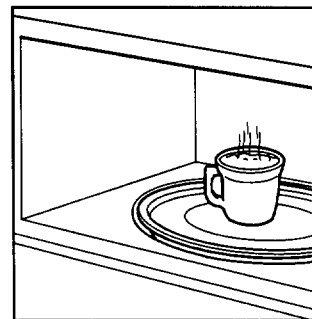

Product life may be shortened.

If you practice programming the oven, **put** a container of water in the oven. It is normal for the oven door to look wavy after the oven has been running for a while.

GETTING TO KNOW YOUR MICROWAVE OVEN

Operating safety precautions (cont.)

Do not use newspaper or other printed paper in the oven. Fire could result.

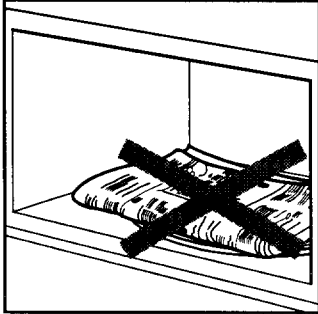

Do not dry flowers, fruit, herbs, wood, paper, gourds, or clothes in the oven. Fire could result.

Do not operate the microwave oven unless the glass turntable is securely in place and can rotate freely.

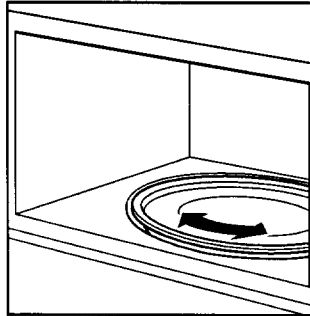

The turntable can rotate in either direction. **Make sure** the support base is all the way on the shaft in the oven cavity floor.

Make sure the rollers are completely inside the center circle of the turntable; this will let the turntable rotate properly.

Make sure the turntable is correct-side up in the oven. **Carefully place** the cookware on your turntable to avoid possibly breaking it.

Handle your turntable with care when removing it from the oven to avoid possibly breaking it. If your turntable cracks or breaks, contact your dealer for a replacement.

When you use a browning dish, the browning dish bottom must be at least $\frac{3}{16}$ inch above the turntable. Follow the directions supplied with the browning dish.

Do not try to melt paraffin wax in the oven. Paraffin wax will not melt in a microwave oven because it allows microwaves to pass through it.

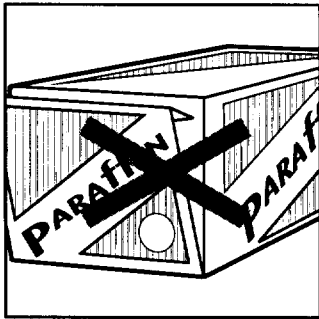

Electrical connection

If your electric power line or outlet voltage is less than 110 volts, cooking times may be longer. Have a qualified electrician check your electrical system.

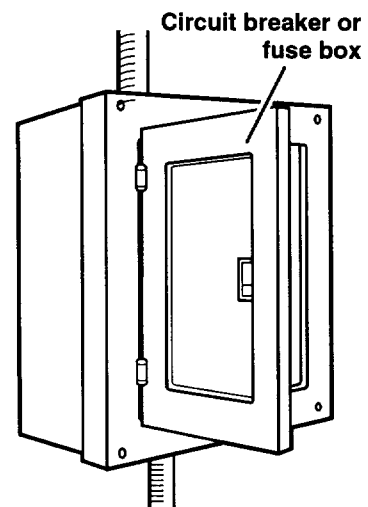
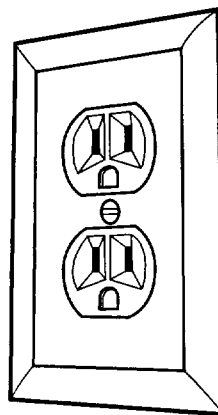

GETTING TO KNOW YOUR MICROWAVE OVEN

Microwave oven features

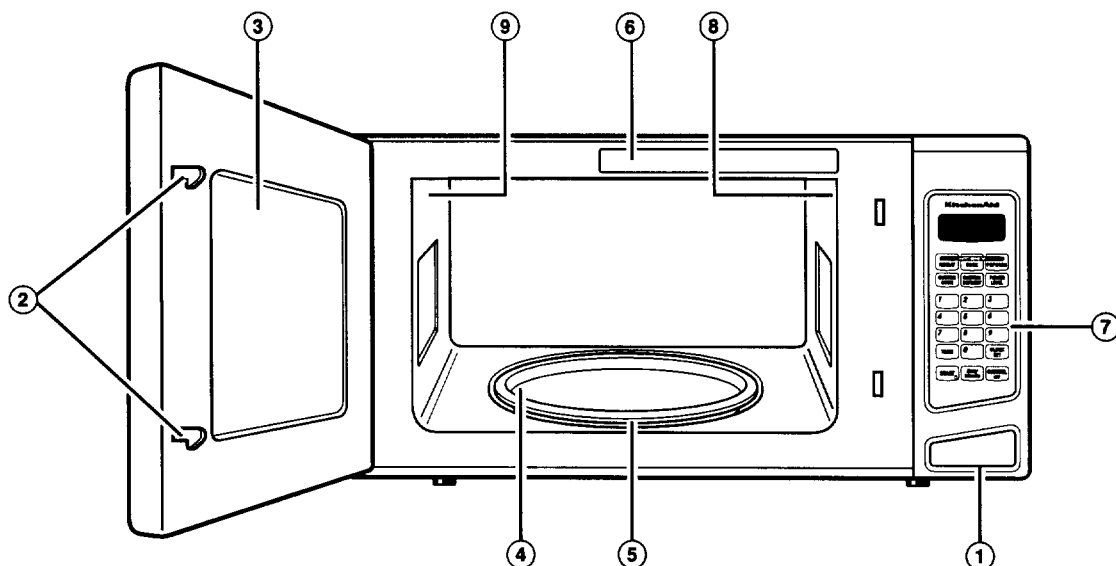

Your microwave oven is designed to make your cooking experience enjoyable and productive. To help get you up and running quickly, the following is a list of the oven's basic features:

- 1. One-Touch Door Open Button.** Push this button to open the door.
- 2. Door Safety Lock System.** The oven will not work unless the door is securely closed.
- 3. Window with Metal Shield.** The shield prevents microwaves from escaping. It is designed as a screen to allow you to view food as it cooks.
- 4. Glass Turntable.** This turntable turns food as it cooks for more even cooking. It must be in the oven during operation for best cooking results. The turntable is sunken into the cavity floor to give you more cooking space and better cooking results. See pages 7, 11, 30, and 39 for more details.

5. Removable Turntable Support (under turntable).

6. Cooking Guide Label.

7. Control Panel. Touch pads on this panel to perform all functions. See pages 13-14 for more information.

8. Light. The light automatically turns on when the door is opened or when the oven is running.

9. Model and Serial Number Plate.

NOTE: This microwave oven is available in both Stainless Steel and DESIGNER WHITE™ models.

GETTING TO KNOW YOUR MICROWAVE OVEN

Control panel features

Your microwave oven control panel lets you choose the cooking function you want quickly and easily. All you have to do is touch the necessary command and number pads located on the control panel. For more information, see pages 15-29.

- 1. Display.** This display includes a clock and indicators to tell you the time of day, cooking time settings, quantities, and cooking functions you chose.
- 2. AUTO SENSOR REHEAT.** Touch this pad to reheat food, without entering a cook power or time. The oven's sensor will tell the oven how long to reheat depending on the amount of humidity it detects from the food. See page 29 for more information.
- 3. AUTO SENSOR COOK.** Touch this pad to cook food without entering a cook power or cook time. The oven's sensor will tell the oven how long to cook depending on the amount of humidity it detects from the food. See page 27 for more information.
- 4. AUTO SENSOR POPCORN.** Touch this pad to pop popcorn, without entering a cook power or time. The oven's sensor will tell the oven how long to cook depending on the amount of humidity it detects from the popcorn. See page 29 for more information.
- 5. CUSTOM COOK.** Touch this pad to cook foods, without entering a cook power or time. See page 22 for more information.
- 6. CUSTOM DEFROST.** Touch this pad to thaw frozen food by weight. See page 23 for more information.
- 7. POWER LEVEL.** Touch this pad, after the cooking time has been set, followed by a Number pad to set the amount of microwave energy released to cook the food. The higher the number, the higher the power or faster the "cooking speed." See page 19 for more information. See the "Microwave cooking chart" on page 32 for specific cook powers to use for the foods you are cooking.
- 8. Number pads.** Touch number pads to enter cooking times, cook powers, quantities, or weights.
- 9. TIMER.** Touch this pad to set the Minute Timer. See page 16 for more information.
- 10. CLOCK SET.** Touch this pad to enter the correct time of day. See page 15 for more information.
- 11. START.** Touch this pad to start a function you have set.

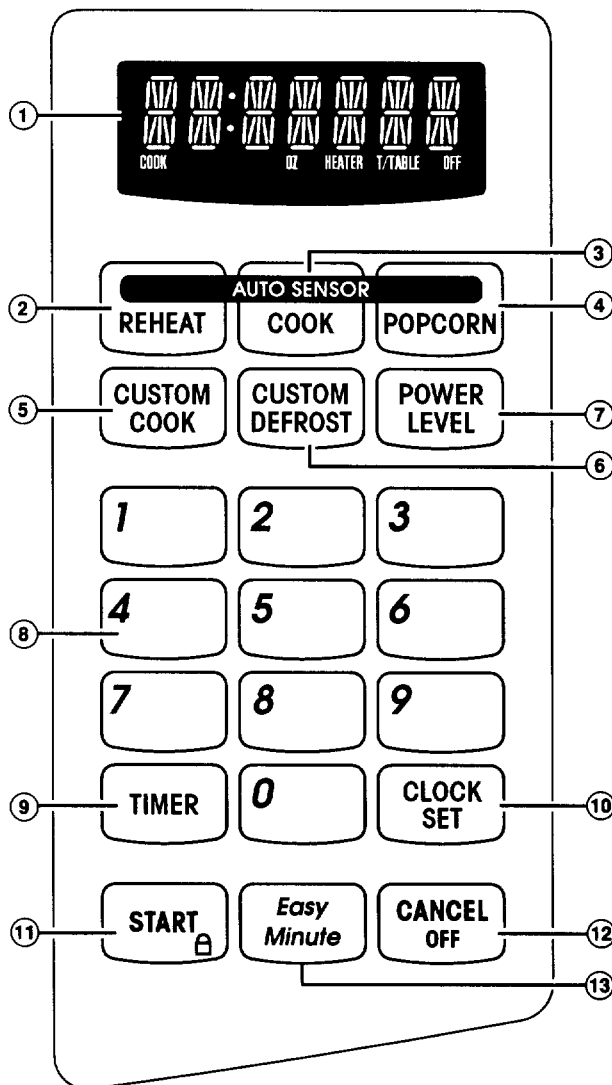

continued on next page

GETTING TO KNOW YOUR MICROWAVE OVEN

Control panel features (cont.)

12. EASY MINUTE. Touch this pad to cook for 1 minute at 100% cook power or to add an extra minute to your cooking cycle (see page 17 for more information).

13. CANCEL/OFF. Touch this pad to erase an incorrect command or to cancel a program during cooking. This pad will not erase the time of day.

NOTE: If you try to enter unacceptable instructions, "ERROR" will appear on the display. Touch CANCEL/OFF and re-enter the instructions.

Audible signals

Your microwave oven comes with audible signals that can guide you when setting and using your oven:

- A programming tone will sound each time you touch a pad.
- Three tones signal the end of a cooking cycle or Minute Timer function.

Interrupting cooking

You can stop the oven during a cycle by opening the door. The oven stops heating and the fan stops, but the light stays on. To restart cooking, close the door and

TOUCH



If you do not want to continue cooking:

- Close the door and the light goes off.

OR

- **TOUCH**



NOTE: Before setting a function, touch CANCEL/OFF to make sure no other function is on.

Using the Child Lock

The Child Lock locks the control panel so children cannot use the microwave when you do not want them to.

To lock the control panel:

TOUCH



until **LOCKED** appears and 2 tones sound (about 5 seconds)

"LOCKED" will appear on the display if a pad is touched.

To unlock the control panel:

TOUCH



until **LOCKED** disappears and 2 tones sound (about 5 seconds)

GETTING TO KNOW YOUR MICROWAVE OVEN

Built-in kits

You can build in your microwave oven by using one of the following trim kits.* These kits are available from your dealer. If your dealer does not stock the kit you can order it, by kit part number, by calling **1-800-422-1230** and following the instructions and telephone prompts you hear.

SIZE	COLOR	KIT MODEL NO.	FOR INSTALLATION OVER KITCHENAID OVEN MODEL	
24"	Stainless Steel	MK1134XGS	KEBI141D	KEBS147D
27"	Stainless Steel	MK1137XGS	KEBI171D	KEBS177D
30"	Stainless Steel	MK1130XGS	KEBI101D	KEBS107D
24"	White	MK1134XGQ	KEBI141D	KEBS147D
27"	White	MK1137XGQ	KEBI171D	KEBS177D
30"	White	MK1130XGQ	KEBI101D	KEBS107D
24"	Black	MK1134XGB	KEBI141D	KEBS147D
27"	Black	MK1137XGB	KEBI171D	KEBS177D
30"	Black	MK1130XGB	KEBI101D	KEBS107D

* KitchenAid-approved, electric single ovens only

Setting the clock

When you first plug in your microwave oven, the display tells you to "PLEASE SET TIME OF DAY" then the display shows ":". If the electric power ever goes off, the display will repeat this message when the power comes back on.

NOTE:

- You can cook without setting the clock, but the display will not show the correct time of day after cooking.

1. Choose the setting.

TOUCH



YOU SEE

display scrolls the words "AM ENTER TIME OF DAY"

NOTE: You can switch between AM and PM by touching CLOCK SET.

2. Enter the time of day.

Example for 3:25:

TOUCH



YOU SEE

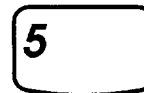
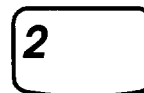

3. Complete your entry.

TOUCH



YOU SEE



GETTING TO KNOW YOUR MICROWAVE OVEN

Using the Minute Timer

You can use your microwave oven as a kitchen timer. Use the Minute Timer for timing up to 99 minutes, 99 seconds.

NOTES:

- To see the time of day while the Minute Timer is counting down, touch CLOCK SET.
- If you want to use other command pads while the Minute Timer is counting down, touch CANCEL/OFF to cancel the Minute Timer.

1. Touch TIMER.

TOUCH



YOU SEE

display scrolls the words
"ENTER TIME IN MIN AND SEC"

2. Enter the time to be counted down.
Example for 3 minutes:

TOUCH

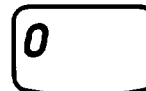
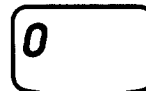
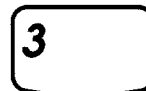

YOU SEE



display scrolls the words
"TOUCH START"

3. Start the countdown.

TOUCH



YOU SEE



(display counts down
set time)

4. When the set time ends, a long tone will sound.

YOU SEE



The display will show the time of day when you touch CANCEL/OFF.

TOUCH



YOU SEE



(time of day)

GETTING TO KNOW YOUR MICROWAVE OVEN

Using EASY MINUTE

EASY MINUTE lets you cook food for 1 minute at 100% cook power or add an extra minute to your cooking cycle. You can also use it to extend cooking time in one-minute amounts.

NOTES:

- Each time you touch EASY MINUTE, it will add 1 minute.
- You can enter EASY MINUTE only after closing the door, after touching CANCEL/OFF, or during cooking.

- If you touch EASY MINUTE during cooking, the oven will cook at the cook power you have set. If you touch EASY MINUTE after cooking, the oven will cook at 100% cook power.
- You can use EASY MINUTE only with timed cooking and CUSTOM COOK.
- You can only use EASY MINUTE to start the oven if no other cooking function is running.

1. Make sure your food is in the oven.

2. Touch EASY MINUTE.

Example when cooking for 1 minute:

TOUCH



once

YOU SEE



3. When the cooking time ends, 3 tones will sound and the oven will stop.

YOU SEE



The display will show the time of day when you touch CANCEL/OFF.

YOU SEE



(time of day)

STANDARD MICROWAVE COOKING

This section gives you instructions for standard microwave cooking. Please read these instructions carefully.

Cooking at high cook power

NOTE: If you use full power for more than 3 hours, the oven will stop on its own.

1. Put your food in the oven and close the door.

2. Set the cooking time.

Example for 1 minute, 30 seconds:

TOUCH

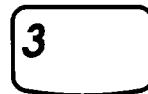

YOU SEE



display scrolls the words
"TOUCH START OR POWER"

3. Start the oven.

TOUCH



YOU SEE



(display counts down
cooking time)

4. When the cooking time ends, 3 tones will sound and the oven will stop.

YOU SEE



The display will show the time of day when you touch CANCEL/OFF.

YOU SEE



(time of day)

STANDARD MICROWAVE COOKING

Cooking at different cook powers

For best results, some recipes call for different cook powers. The lower the cook power, the slower the cooking. Each number pad also stands for a different percentage of cook power. Many microwave cookbook recipes tell you by number, percent, or name which cook power to use.

The following chart gives the percentage of cook power each number pad stands for, and the cook power name usually used. It also tells you when to use each cook power. Follow recipe or food package instructions if available.

NOTE: Refer to a reliable cookbook for cooking times.

COOK POWER	NAME	WHEN TO USE IT
10=100% of full power (automatic)	High	<ul style="list-style-type: none"> • Quick heating many convenience foods and foods with high water content, such as soups and beverages • Cooking small tender pieces of meat, ground meat, poultry pieces, fish fillets, and most vegetables
9=90% of full power	Medium-High	• Heating cream soups
8=80% of full power		• Heating rice, pasta, or stirrable casseroles
7=70% of full power		<ul style="list-style-type: none"> • Cooking and heating foods that need a cook power lower than high (for example, whole fish and meat loaf) or when food is cooking too fast • Reheating a single serving of food
6=60% of full power	Medium	<ul style="list-style-type: none"> • Cooking sensitive foods, such as cheese and egg dishes, pudding, and custards • Cooking non-stirrable casseroles (i.e., lasagna)
5=50% of full power		<ul style="list-style-type: none"> • Cooking ham, whole poultry, and pot roasts • Melting chocolate
4=40% of full power	Medium-Low, Defrost	<ul style="list-style-type: none"> • Simmering stews • Heating pastries
3=30% of full power		<ul style="list-style-type: none"> • Defrosting foods, such as bread, fish, meats, poultry, and precooked foods
2=20% of full power	Low	• Softening butter, cheese, and ice cream
1=10% of full power		<ul style="list-style-type: none"> • Keeping food warm • Taking chill out of fruit

STANDARD MICROWAVE COOKING

Cooking at different cook powers (cont.)

1. Put your food in the oven and close the door.

2. Set the cooking time.

Example for 7 minutes, 30 seconds:

TOUCH



YOU SEE



display scrolls the words
"TOUCH START OR POWER"

3. Set the cook power.

TOUCH



YOU SEE

display scrolls the words
"ENTER POWER LEVEL 1 TO 10"

Example for 50% cook power:

TOUCH



YOU SEE



STANDARD MICROWAVE COOKING

Cooking at different cook powers (cont.)

4. Start the oven.

TOUCH



YOU SEE



(display counts down cooking time)

5. When the cooking time ends, 3 tones will sound and the oven will stop.

YOU SEE



The display will show the time of day when you touch CANCEL/OFF.

YOU SEE



(time of day)

STANDARD MICROWAVE COOKING

Using CUSTOM COOK

CUSTOM COOK lets you cook common microwave-prepared foods without needing to set times and cook powers. CUSTOM COOK has preset times and cook powers for 6 types of food: Bacon, Frozen Roll/Muffin, Fresh Roll/Muffin, Beverage, Chicken Pieces, and Hot Cereal.

All you do is touch CUSTOM COOK, then enter the number of items being heated. Your microwave oven does the rest.

NOTES:

- If you want to cook by entering a time and cook power, see "Microwave cooking chart" in the "Cooking Guide" section.
- For the food settings available see the "Custom cook chart" below or the Cooking Guide Label on the frame behind the door.

To use CUSTOM COOK:

1. Put your food in the oven and close the door.

2. Touch



3. Touch one of these Number pads to choose the type of food.

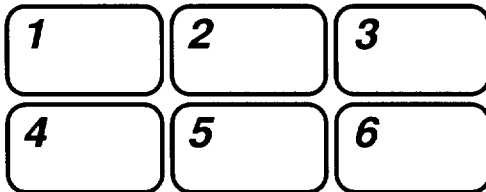

4. Touch one of more of these Number pads to enter the amount.

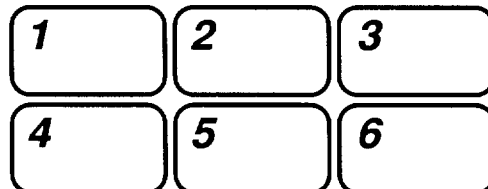

This chart tells you how to choose a food type and what amounts you can cook.

NUMBER PAD	FOOD	INSTRUCTIONS	AMOUNT
1	Bacon	Place bacon strips on a paper plate or dinner plate lined with paper towels or on a microwave bacon rack.	2 to 6 slices
2	Frozen Roll/Muffin	Remove from the package and place on a plate. If baked good size is over 3 oz each, enter serving size as "2".	1 to 6 each (2 to 3 ounces each)
3	Fresh Roll/Muffin	Remove from the package and place on a plate. If baked good size is over 3 oz each, enter serving size as "2".	1 to 6 each (2 to 3 ounces each)
4	Beverage	Stir liquid several times during heating. Be careful when removing the beverage. It will be very hot.	1 to 2 cups
5	Chicken Pieces	Place the fresh chicken pieces in a microwavable container. Cover with plastic wrap and vent.	½ to 2.0 lbs
6	Hot Cereal	Prepare as directed on the package and cook. Stir before eating. Use only instant hot cereal.	1 to 6 servings

STANDARD MICROWAVE COOKING

Using CUSTOM DEFROST

You can defrost food by choosing a category and setting a weight. CUSTOM DEFROST has preset times and cook powers for 3 categories: Meat, Poultry, and Fish.

To use CUSTOM DEFROST, follow the steps below:

1. Touch



2. Touch one of three Number pads to choose the type of food.

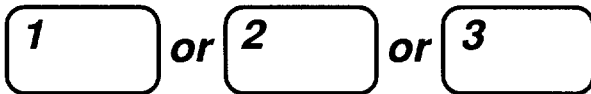

3. Touch Number pad(s) to enter the weight.

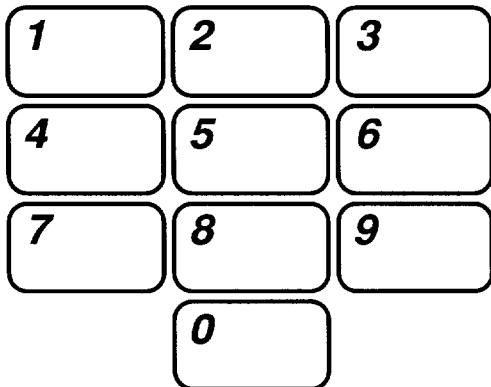

4. Touch



NOTES:

- See the "Custom defrost chart" later in this section for defrosting directions for each food.
- To defrost items not listed in the "Custom defrost chart," use 30% cook power. Refer to a reliable cookbook for defrosting information.
- Twice during defrosting, the display will ask you to turn food over. After you do so, close the door and touch START to continue defrosting. See the "Custom defrost chart" later in this section for instructions on what to do when you see this message.

This chart shows you how to choose a type of food and the weights you can set for each type.

FOOD	TOUCH NUMBER PAD	WEIGHTS YOU CAN SET (tenths of a pound)
Meat	1	.1 to 6.0
Poultry	2	.1 to 6.0
Fish	3	.1 to 6.0

STANDARD MICROWAVE COOKING

Custom defrost chart

I. Meat setting

FOOD	WHEN YOU SEE MESSAGE	SPECIAL INSTRUCTIONS
Beef		Meat of irregular shape and large, fatty cuts of meat should have the narrow or fatty areas shielded with foil at the beginning of a defrost cycle.
Ground Beef, Bulk	Remove thawed portions with fork. Turn over. Return remainder to oven.	Do not defrost less than ¼ lb.
Ground Beef, Patties	Separate and rearrange.	Do not defrost less than two 4 oz patties.
Round Steak	Turn over. Cover warm areas with aluminum foil.	Place on a microwavable roasting rack.
Tenderloin Steak	Turn over. Cover warm areas with aluminum foil.	Place on a microwavable roasting rack.
Stew Beef	Remove thawed portions with fork. Separate remainder. Return remainder to oven.	Place in a microwavable baking dish.
Pot Roast, Chuck Roast	Turn over. Cover warm areas with aluminum foil.	Place on a microwavable roasting rack.
Rib Roast	Turn over. Cover warm areas with aluminum foil.	Place on a microwavable roasting rack.
Rolled Rump Roast	Turn over. Cover warm areas with aluminum foil.	Place on a microwavable roasting rack.
Lamb		
Cubes for Stew	Remove thawed portions with fork. Return remainder to oven.	Place in a microwavable baking dish.
Chops (1 inch thick)	Separate and rearrange.	Place on a microwavable roasting rack.
Pork		
Chops (½ inch thick)	Separate and rearrange.	Place on a microwavable roasting rack.
Hot Dogs	Separate and rearrange.	Place on a microwavable roasting rack.
Spareribs, Country-Style Ribs	Turn over. Cover warm areas with aluminum foil.	Place on a microwavable roasting rack.
Sausage, Links	Separate and rearrange.	Place on a microwavable roasting rack.
Sausage, Bulk	Remove thawed portions with fork. Turn over. Return remainder to oven.	Place in a microwavable baking dish.
Loin Roast, Boneless	Turn over. Cover warm areas with aluminum foil.	Place on a microwavable roasting rack.

STANDARD MICROWAVE COOKING

Custom defrost chart (cont.)

2. Poultry setting

FOOD	WHEN YOU SEE MESSAGE	SPECIAL INSTRUCTIONS
Chicken		
Whole	Turn over (finish defrosting breast-side down). Cover warm areas with aluminum foil.	Place chicken breast-side up on a microwavable roasting rack. Finish defrosting by immersing in cold water. Remove giblets when chicken is partially defrosted.
Cut Up	Separate pieces and rearrange. Turn over. Cover warm areas with aluminum foil.	Place on a microwavable roasting rack. Finish defrosting by immersing in cold water.
Cornish Hens		
Whole	Turn over. Cover warm areas with aluminum foil.	Place on a microwavable roasting rack. Finish defrosting by immersing in cold water.
Turkey		
Breast	Turn over. Cover warm areas with aluminum foil.	Place on a microwavable roasting rack. Finish defrosting by immersing in cold water.

3. Fish setting

FOOD	WHEN YOU SEE MESSAGE	SPECIAL INSTRUCTIONS
Fish		
Fillets	Turn over. Separate fillets when partially thawed.	Place in a microwavable baking dish. Carefully separate fillets under cold water.
Steaks	Separate and rearrange.	Place in a microwavable baking dish. Run cold water over to finish defrosting.
Whole	Turn over.	Place in a microwavable baking dish. Cover head and tail with foil; do not let foil touch sides of microwave oven. Finish defrosting by immersing in cold water.
Shellfish		
Crabmeat	Break apart. Turn over.	Place in a microwavable baking dish.
Lobster Tails	Turn over and rearrange.	Place in a microwavable baking dish.
Shrimp	Separate and rearrange.	Place in a microwavable baking dish.
Scallops	Separate and rearrange.	Place in a microwavable baking dish.

STANDARD MICROWAVE COOKING

Defrosting tips

- When using CUSTOM DEFROST, you need to enter the net weight (the weight of the food minus the container). Enter the weight to the nearest $\frac{1}{10}$ lb.
- Only use CUSTOM DEFROST for raw food. CUSTOM DEFROST gives best results when the food to be thawed is completely frozen. If the food is partially defrosted, always set a lower food weight (for a shorter defrosting time) to prevent cooking the food.
- The shape of the package affects how quickly food will defrost. Shallow packages will defrost more quickly than a deep block.
- As food begins to defrost, separate the pieces. Separated pieces defrost more evenly.
- Use small pieces of aluminum foil to shield parts of food such as chicken wings, leg tips, fish tails, or areas that start to get warm. Make sure the foil does not touch the sides, top, or bottom of the oven.
- For better results, a preset standing time is included in the defrosting time. This may make the defrosting time seem longer than expected. (For more information on standing time, see "Microwave cooking tips" in the "Cooking Guide" section.)

Weight conversion chart

You are probably used to food weights as being in pounds and ounces that are fractions of a pound (for example 4 ounces equals $\frac{1}{4}$ pound). However, in order to enter food weight in CUSTOM DEFROST, you must specify pounds and tenths of a pound.

If the weight on the food package is in fractions of a pound, you can use the following chart to convert the weight to decimals.

DECIMAL WEIGHT	EQUIVALENT OUNCE WEIGHT	EQUIVALENT GRAM WEIGHT
.10	1.6	45
.20	3.2	91
.25 One-Quarter Pound	4.0	113
.30	4.8	136
.40	6.4	181
.50 One-Half Pound	8.0	227
.60	9.6	272
.70	11.2	318
.75 Three-Quarters Pound	12.0	340
.80	12.8	363
.90	14.4	408
1.00 One Pound	16.0	454

AUTO SENSOR COOKING

Your microwave oven has a sensor that detects the humidity released by the food. The amount of humidity detected tells the oven how long to cook or heat your food. The sensor is used by three special functions: AUTO SENSOR COOK, AUTO SENSOR REHEAT, and AUTO SENSOR POPCORN. The simple instructions for these functions are on the following pages.

Using AUTO SENSOR COOK

AUTO SENSOR COOK has preset cook powers for cooking 10 different types of food.

To use AUTO SENSOR COOK:

1. Put the food in the oven and close the door.

2. Touch



3. Touch a Number pad to choose the type of food.

NOTE: See the chart below for the types of food to choose from.

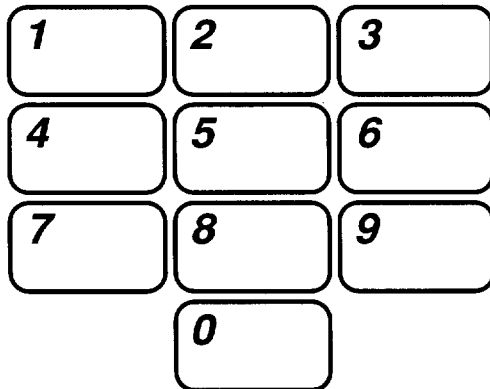

NOTES:

- If you want to cook by entering a time and cook power, see "Microwave cooking chart" in the "Cooking Guide" section.
- The oven should be plugged in at least 5 minutes before sensor cooking.
- Room temperature should not exceed 95°F.
- Be sure the exterior of the cooking container and the interior of the oven are dry. Wipe off each with a paper towel.
- The oven will not generate microwave energy for approximately 28 seconds at the beginning of the sensor cooking cycle.

This chart tells you how to choose a food type and what amounts you can cook.

NUMBER PAD	FOOD	INSTRUCTIONS	AMOUNT
1	Potato	Pierce each potato 3 times with a fork and place on the oven tray around the edge, at least 1 inch apart.	1 to 4, about 10 to 13 oz each
2	Fresh Vegetable	Place moist vegetables in a microwavable container. Cover with plastic wrap and vent.	1 to 6 cups
3	Frozen Vegetable	Remove from package. Place vegetables in a microwavable container. Cover with plastic wrap and vent.	5 to 16 oz

continued on next page

AUTO SENSOR COOKING

Using AUTO SENSOR COOK (cont.)

NUMBER PAD	FOOD	INSTRUCTIONS	AMOUNT
4	Frozen Entrée	Remove from outer package. Loosen cover on three sides. If entrée is not in a microwave-safe container, place it on a plate, cover with plastic wrap and vent.	Works best if entrée is 10 to 21 oz.
5	Rice	Follow measurements on package for ingredient amounts. Place rice and liquid (water or chicken or vegetable stock) in a microwavable dish. Cover with plastic wrap. When cooking is complete, allow rice to stand 5 minutes or until liquid is absorbed. Stir rice.	½ to 2 cups of dry rice Use medium or long grain rice. Cook instant rice according to directions on the package.
6	Casserole	Combine the ingredients per the recipe in a 1- to 2-quart casserole. Cover with plastic wrap and vent. After cooking is complete, allow 5 minutes standing time.	1 to 3 cups
7	Ground Meat	Crumble meat into a microwavable container. Season and cover with plastic wrap. Vent cover for well-done meat.	¼ to 2 lbs
8	Fish, Seafood	Place the food around the sides of a microwave-safe container. Season and add ¼- to ½-cup liquid (wine, water, salsa, etc.) if desired. Cover with plastic wrap, vented.	¼ to 2 lbs
9	Eggs, Scrambled	Break eggs into a 4-cup measuring cup or 1-quart casserole. Add 1 tablespoon milk or water per egg and beat. Cover with plastic wrap, vented. When cooking is complete, remove from oven, stir, and allow 1 to 2 minutes standing time.	1 to 5 eggs
0	Frozen Pizza	Follow package directions.	1 to 2 servings

AUTO SENSOR COOKING

Using AUTO SENSOR REHEAT

AUTO SENSOR REHEAT has preset cook powers for 3 different types of food.

NOTE: If you want to reheat by entering a time and cook power, see the "Reheating chart" in the "Cooking Guide" section.

To use AUTO SENSOR REHEAT:

1. Put the food in the oven and close the door.
2. Touch



3. Touch one of three Number pads to choose the type of food.

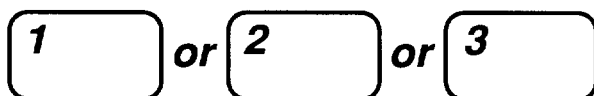

This chart tells you how to choose a food type and what amounts you can reheat.

NUMBER PAD	FOOD	INSTRUCTIONS	AMOUNT
1	Dinner Plate	Place food to be heated on a dinner plate or similar dish. Cover with plastic wrap and vent.	about 8 to 16 oz
2	Soup/Sauce	Place food to be heated in a microwave container. Cover with plastic wrap and vent.	1 to 4 cups
3	Casserole	Place food to be heated in a microwave container. Cover with plastic wrap and vent.	1 to 2 cups

Using AUTO SENSOR POPCORN

AUTO SENSOR POPCORN lets you pop commercially packaged microwave popcorn by touching just 1 pad.

NOTES:

To use SENSOR POPCORN:

1. Place the bag in the center of the turntable and close the door.
2. Touch



- Pop only 1 package at a time.
- If you are using a microwave popcorn popper, follow manufacturer's instructions.
- How well your popcorn cooks will depend on the brand of popcorn and how much fat it has in it. Try several brands to decide which pops the best. For best results, use fresh bags of popcorn.

CARING FOR YOUR MICROWAVE OVEN

To make sure your microwave oven looks good and works well for a long time, you should maintain it properly. For proper care, please follow these instructions carefully.

For interior surfaces: Wash often with warm, sudsy water and a sponge or soft cloth. Use only mild, nonabrasive soaps or a mild detergent. Be sure to keep the areas clean where the door and oven frame touch when closed. Wipe well with clean water. Over time, stains can occur on the surfaces as the result of food particles spattering during cooking. This is normal.

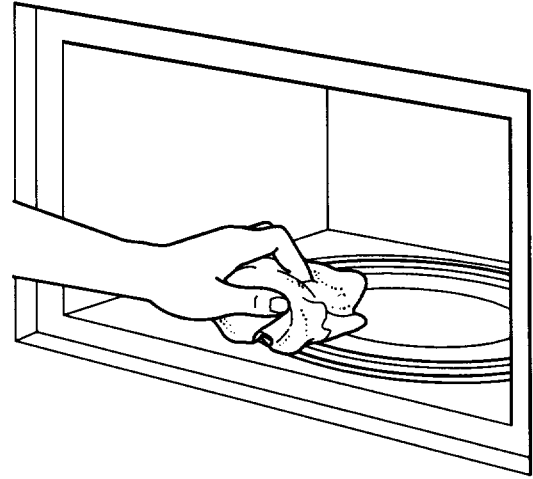

For stubborn soil, **boil** a cup of water in the oven for 2 or 3 minutes. Steam will soften the soil. To get rid of odors inside the oven, **boil** a cup of water with lemon juice or vinegar in it.

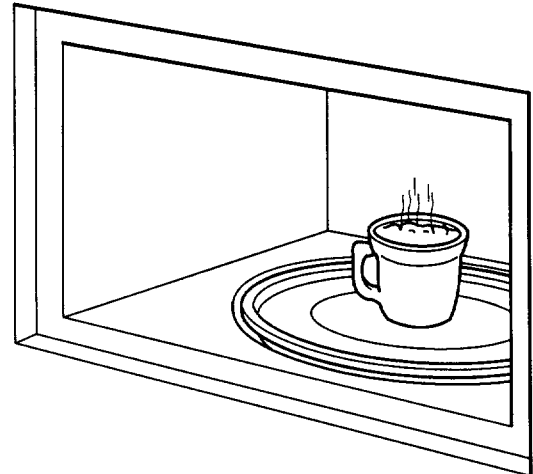

For exterior surfaces and control panel: Use a soft cloth with spray glass cleaner. Apply the spray glass cleaner to the soft cloth; do not spray directly on the oven.

NOTE: Abrasive cleansers, steel-wool pads, gritty wash cloths, some paper towels, etc., can damage the control panel and the interior and exterior oven surfaces.

To clean turntable and turntable support, wash in mild, sudsy water; for heavily soiled areas use a mild cleanser and scouring sponge. The turntable and turntable support are dishwasher safe.

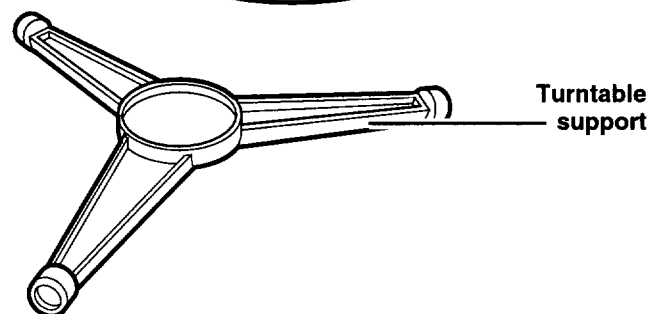
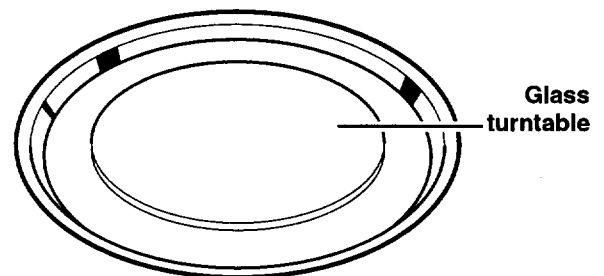

COOKING GUIDE

Reheating chart

Times are approximate and may need to be adjusted to individual taste.

NOTE: See "Using AUTO SENSOR REHEAT" in the "Auto Sensor Cooking" section for instructions on how to reheat without cook time and cook power.

ITEM	STARTING TEMPERATURE	MICROWAVE TIME	INSTRUCTIONS
Plate of Food		MEDIUM - HIGH (70%)	
1 serving of meat	Room temp.	1½ to 2¾ min.	Meaty portion and bulky vegetables to outside. Cover with wax paper.
2 servings of vegetables	Refrigerated	2¾ to 4 min.	
Meat (Chicken pieces, chops, hamburgers, meat loaf slices)		MEDIUM - HIGH (70%)	Cover loosely with wax paper.
1 serving	Refrigerated	1 to 2 min.	
2 servings	Refrigerated	2 to 4 min.	
Meat Slices (Beef, ham, pork, turkey)		MEDIUM (50%)	Cover with gravy or wax paper. Check after 30 sec. per serving.
1 or more servings	Room temp.	1 to 1¼ min. per serving	
	Refrigerated	1½ to 2½ min. per serving	
Stirrable Casseroles and Main Dishes		HIGH (100%)	Cover with plastic wrap. Stir after half the time.
1 serving	Refrigerated	2¾ to 3½ min.	
2 servings	Refrigerated	5 to 6¾ min.	
4 to 6 servings	Refrigerated	9 to 10 min.	
Non-stirrable Casseroles and Main Dishes		MEDIUM (50%)	Cover with wax paper.
1 serving	Refrigerated	4½ to 7½ min.	
2 servings	Refrigerated	7½ to 11 min.	
4 to 6 servings	Refrigerated	12 to 15 min.	
Soup, Cream		MEDIUM (50%)	Cover. Stir after half the time.
1 cup	Refrigerated	2 to 5½ min.	
1 can (10¾ oz.)	Room temp.	5 to 7½ min.	
Soup, Clear		HIGH (100%)	Cover. Stir after half the time.
1 cup	Refrigerated	2 to 3 min.	
1 can (10¾ oz.)	Room temp.	3½ to 7 min.	
Pizza		HIGH (100%)	Place on paper towel on microwave-safe rack.
1 slice	Room temp.	15 to 25 sec.	
1 slice	Refrigerated	25 to 35 sec.	
2 slices	Room temp.	25 to 35 sec.	
2 slices	Refrigerated	55 to 60 sec.	
Vegetables		HIGH (100%)	Cover. Stir after half the time.
1 serving	Refrigerated	¾ to 1¼ min.	
2 servings	Refrigerated	1½ to 2 min.	
Baked Potato		HIGH (100%)	Cut potato lengthwise and then several times crosswise. Cover with wax paper.
1	Refrigerated	1 to 2½ min.	
2	Refrigerated	2½ to 3 min.	

continued on next page

COOKING GUIDE

Reheating chart (cont.)

ITEM	STARTING TEMPERATURE	MICROWAVE TIME	INSTRUCTIONS
Breads (Dinner or breakfast roll)		HIGH (100%)	Wrap single roll, bagel, or muffin in paper towel. To reheat several, line plate with paper towel; cover with another paper towel.
1 roll	Room temp.	10 to 15 sec.	
2 rolls	Room temp.	15 to 20 sec.	
4 rolls	Room temp.	25 to 30 sec.	
Pie		HIGH (100%)	Place on microwave-safe dish. Do not cover.
1 slice	Refrigerated	30 sec. to 1 min.	
2 slices	Refrigerated	1 to 1½ min.	

NOTE: After reheating, food should be very hot. If possible, stir food, cover, and allow to stand 2 to 3 minutes before serving.

Microwave cooking chart

Times are approximate and may need to be adjusted to individual taste.

NOTE: See "Using CUSTOM COOK" in the "Standard Microwave Cooking" section for instructions on how to cook without cooking time and cook power.

Meat roasting chart

CUT	COOKING PREPARATION	MICROWAVE INSTRUCTIONS	INTERNAL TEMP. AT REMOVAL	INTERNAL TEMP. AFTER STANDING
Beef				
Chuck or Pot Roast (cook in ½ cup liquid) (2 to 3 lbs)	Large covered casserole. Turn over halfway through cooking time.	MEDIUM (50%) 21 to 24 min. per lb 27 to 30 min. per lb	150° F	160° F
Without vegetables With 3 to 4 cups cut-up vegetables				
Eye of Round (2 to 3 lbs)	Rack. Cover with plastic wrap. Turn over halfway through cooking time.	MEDIUM (50%) Rare: 5 to 8 min. per lb Med: 7 to 10 min. per lb Well: 9 to 11 min. per lb	120° F	130° F
Ground Meat (to brown for casserole)			135° F	145° F
			150° F	160° F
Hamburgers (¼ lb. each)	Rack. Cover with wax paper. Turn over halfway through cooking time.	HIGH (100%) 3½ to 5 min. per lb.	155° F	160° F
2 patties 4 patties				

COOKING GUIDE

Meat roasting chart (cont.)

CUT	COOKING PREPARATION	MICROWAVE INSTRUCTIONS	INTERNAL TEMP. AT REMOVAL	INTERNAL TEMP. AFTER STANDING
Pork				
Loin Roast	Meat roasting rack. Cover with plastic wrap.	MEDIUM - HIGH (70%) 7 to 11 min. per lb.	160° F	170° F
Boneless	Turn over halfway through cooking time.	MEDIUM (50%) 12 to 14 min. per lb	160° F	170° F
Smoked Ham	Casserole. Cover with plastic wrap. Turn over halfway through cooking time. Drain and shield if necessary.	MEDIUM (50%) 5 to 8 min. per lb	130° F	135° F
Canned		8 to 11 min. per lb	130° F	135° F
Butt Shank				

Poultry roasting chart

CUT	COOKING PREPARATION	MICROWAVE INSTRUCTIONS	INTERNAL TEMP. AT REMOVAL	INTERNAL TEMP. AFTER STANDING
Chicken				
Whole	Breast side down on rack. Cover with plastic wrap. Turn over halfway through cooking time.	MEDIUM - HIGH (70%) 5 to 8 min. per lb	170° F	180° F
Pieces	Rack. Cover with plastic wrap. Turn over halfway through cooking time.	HIGH (100%) 5 to 7½ min. per lb	170° F	180° F
Bone-in Boneless		4 to 7 min. per lb	160° F	170° F
Turkey				
Whole (up to 10 lbs.)	Breast side down on rack. Cover with plastic wrap. Turn over halfway through cooking time.	MEDIUM (50%) 10 to 14 min. per lb	170° F	180° F
Breast	Rack. Cover with plastic wrap. Turn over halfway through cooking time.	MEDIUM (50%) 11 to 15 min. per lb	160° F	170° F
Bone-in Boneless		14 to 18 min. per lb	160° F	170° F

Fish and seafood cooking chart

CUT	COOKING PREPARATION	MICROWAVE INSTRUCTIONS	STANDING TIME
Filletts	Pie plate or casserole. Cover with plastic wrap.	POWER LEVEL (80%) 4 to 6 min. per lb	3 min.
Steaks	Pie plate or casserole. Cover with plastic wrap. Turn over halfway through cooking time.	POWER LEVEL (80%) 5 to 8 min. per lb	3 min.

continued on next page

COOKING GUIDE

Fish and seafood cooking chart (cont.)

CUT	COOKING PREPARATION	MICROWAVE INSTRUCTIONS	STANDING TIME
Shrimp & Scallops	Pie plate or casserole. Cover with plastic wrap. Turn over halfway through cooking time.	POWER LEVEL (80%) 4 to 8 min. per lb	1 to 2 min.

Vegetable cooking chart

VEGETABLE	AMOUNT	COOKING INSTRUCTIONS	MICROWAVE TIME AT HIGH (100%)	STANDING TIME, COVERED
Artichokes				
Fresh	2 medium	Trim and rinse. 2-qt. casserole. 2 tbsp. water. Cover with plastic wrap.	5 to 8 min.	5 min.
Asparagus				
Fresh Spears	1 lb	2-qt. casserole. 2 tbsp. water. Cover. Rearrange after 3 min.	4 to 7 min.	2 min.
Frozen Spears	10-oz pkg.	1-qt. casserole. 1 tbsp. water. Cover. Rearrange after 3 min.	7 to 9 min.	2 min.
Beans				
Fresh, Green and Wax	1 lb	1½-inch pieces. 2-qt. casserole. ¼ cup water. Cover. Stir twice.	9 to 13 min.	2 min.
Frozen, Green	10-oz pkg.	1-qt. casserole. 1 tbsp. water. Cover. Stir after 3 min.	5 to 7 min.	2 min.
Frozen, Lima	10-oz pkg.	1-qt. casserole. 1 tbsp. water. Cover. Stir once.	6 to 9 min.	2 min.
Beets				
Fresh, Whole	5 medium	Wash. Leave 1 inch of tops. 2-qt. casserole. ¼ cup water. Cover. Stir every 5 min.	12 to 18 min.	3 min.
Broccoli				
Fresh, Spears	1 lb	Wash. 2-qt. casserole. Add no water. Cover. Rearrange after 3 min. Uncover during stand.	6 to 8 min.	3 min., uncovered
Fresh, Pieces	1 lb	Wash. 2-qt. casserole. Add no water. Cover. Stir after 3 min. Uncover during stand.	5 to 7 min.	2 min., uncovered
Frozen, Spears, Cuts, Chopped	10-oz pkg.	1-qt. casserole. 2 tbsp. water. Cover. Stir after 3 min. Uncover during stand.	5 to 7 min.	2 min., uncovered

COOKING GUIDE

Vegetable cooking chart (cont.)

VEGETABLE	AMOUNT	COOKING INSTRUCTIONS	MICROWAVE TIME AT HIGH (100%)	STANDING TIME, COVERED
Brussels Sprouts				
Fresh	4 cups	2-qt. casserole. ¼ cup water. Cover. Stir after 2 min.	6 to 8 min.	3 min.
Frozen	10-oz pkg.	1-qt. casserole. 2 tbsp. water. Cover. Stir after 3 min.	6 to 8 min.	3 min.
Cabbage				
Shredded	1 lb	2-qt. casserole. 2 tbsp. water. Cover. Stir after 4 min.	8 to 12 min.	2 min.
Wedges	1 lb	2-qt. casserole. 2 tbsp. water. Cover. Rearrange after 5 min.	12 to 14 min.	3 min.
Carrots				
Fresh, Slices	2 cups	1-qt. casserole. 2 tbsp. water. Cover. Stir after 3 min.	4 to 8 min.	3 min.
Frozen, Slices	2 cups	1-qt. casserole. 1 tbsp. water. Cover. Stir after 3 min.	5 to 8 min.	3 min.
Cauliflower				
Fresh, Flowerets	2 cups	1-qt. casserole. 1 tbsp. water. Cover. Stir after 2 min.	3 to 5 min.	2 min.
Fresh, Whole	1½ lbs	Remove leaves and core center. 2-qt. casserole. 2 tbsp. water. Cover.	7 to 9 min.	3 min.
Frozen, Flowerets	10-oz pkg.	1-qt. casserole. 1 tbsp. water. Cover. Stir after 3 min.	4 to 6 min.	2 min.
Corn				
Fresh, on Cob	2 ears	9-in. pie plate. 2 tbsp. water. Cover. Rearrange after 4 min.	6 to 9 min.	5 min.
	4 ears	2-qt. oval or rectangular casserole. ¼ cup water. Cover.	12 to 14 min.	5 min.
Frozen, on Cob	2 ears	9-in. pie plate. 2 tbsp. water. Cover. Rearrange after 4 min.	6 to 8 min.	5 min.
	4 ears	2-qt. oval or rectangular casserole. ¼ cup water. Cover.	10 to 12 min.	5 min.
Frozen, Whole Kernel	10-oz pkg.	1-qt. casserole. 1 tbsp. water. Cover. Stir after 2 min.	4 to 6 min.	2 min.
Okra				
Fresh, Whole	¾ lb	1½ to 2-qt. casserole. ¼ cup water. Cover. Stir after 3 min.	8 to 10 min.	3 min.
Frozen, Whole or Slices	10-oz pkg.	1½ to 2-qt. casserole. 2 tbsp. water. Cover. Stir after 3 min.	6 to 8 min.	3 min.
Peas, Black-Eyed				
Frozen	10-oz pkg.	2-qt. casserole. ¼ cup water. Cover. Stir after 4 min.	8 to 10 min.	3 min.

continued on next page

COOKING GUIDE

Vegetable cooking chart (cont.)

VEGETABLE	AMOUNT	COOKING INSTRUCTIONS	MICROWAVE TIME AT HIGH (100%)	STANDING TIME, COVERED
Peas, Green				
Fresh	2 cups	1-qt. casserole. ¼ cup water. Cover. Stir after 3 min.	4 to 6 min.	3 min.
Frozen	10-oz pkg.	1-qt. casserole. 1 tbsp. water. Cover. Stir after 3 min.	6 to 8 min.	3 min.
Potatoes				
Baked	2 medium	Pierce. Place on paper towels. Let stand, foil wrapped.	7 to 9 min.	5 to 10 min.
	4 medium		11 to 13 min.	5 to 10 min.
Boiled	4 medium	Peel and quarter potatoes. Add ½ cup of water. 2-qt. casserole. Cover. Stir after 5 min.	9 to 12 min.	3 min.
Spinach				
Fresh	1 lb	Wash and trim. Add no water. 3-qt. casserole. Cover. Stir after 3 min.	5 to 7 min.	2 min.
Frozen, Leaf or Chopped	10-oz pkg.	1-qt. casserole. Add no water. Cover. Stir after 3 min.	6 to 8 min.	2 min.
Squash				
Fresh, Acorn	1 whole	Pierce. Place on paper towel. Turn over after 4 min.	7 to 10 min.	5 min.
Fresh, Sliced Zucchini	2 cups	1-qt. casserole. Add no water. Cover. Stir after 2 min.	2 to 4 min.	1 min.
Frozen, Mashed	10-oz pkg.	1-qt. casserole. Add no water. Cover. Break apart and stir after 3 min.	6 to 8 min.	2 min.
Sweet Potatoes				
Baked	2 medium	Pierce. Place on paper towels. Let stand, foil wrapped.	5 to 9 min.	5 min.
	4 medium		10 to 13 min.	5 min.
Tomatoes				
Fresh	2 medium	Halve tomatoes. Round dish. Cover. Rearrange once.	2 to 4 min.	2 min.
	4 medium		5 to 8 min.	2 min.
Vegetables, Canned	15 to 16 oz	1-qt. casserole. Drain all but 2 tbsp. liquid. Stir once.	2 to 4 min.	2 min.

COOKING GUIDE

Microwave cooking tips

Amount of food

- **If you increase or decrease** the amount of food you prepare, the time it takes to cook that food will also change. For example, if you double a recipe, add a little more than half the original cooking time. Check for doneness and, if necessary, add more time in small increments.

Starting temperature of food

- **The lower the temperature** of the food being put into the microwave oven, the longer it takes to cook. Food at room temperature will be reheated more quickly than food at refrigerator temperature.

Composition of food

- **Food with a lot of fat and sugar** will be heated faster than food containing a lot of water. Fat and sugar will also reach a higher temperature than water in the cooking process.
- **The more dense the food**, the longer it takes to heat. "Very dense" food like meat takes longer to reheat than lighter, more porous food like sponge cakes.

Size and shape

- **Smaller pieces of food** will cook faster than larger pieces. Also, same-shaped pieces cook more evenly than different-shaped pieces.
- **With foods that have different thicknesses**, the thinner parts will cook faster than the thicker parts. **Place** the thinner parts of chicken wings and legs in the center of the dish.

Stirring, turning foods

- **Stirring and turning foods** spreads heat quickly to the center of the dish and avoids overcooking at the outer edges of the food.

Covering food

Cover food to:

- **Reduce** splattering
- **Shorten** cooking times
- **Keep** food moist

You can use any covering that lets microwaves pass through.

Releasing pressure in foods

- **Several foods** (for example: baked potatoes, sausages, egg yolks, and some fruits) are tightly covered by a skin or membrane. Steam can build up under the membrane during cooking, causing the food to burst. To relieve the pressure and to prevent bursting, **pierce** these foods before cooking with a fork, cocktail pick, or toothpick.

Using standing time

- **Always allow food to stand** after cooking. Standing time after defrosting and cooking allows the temperature to evenly spread throughout the food, improving the cooking results.
- **The length of the standing time** depends on how much food you are cooking and how dense it is. Sometimes it can be as short as the time it takes you to remove the food from the oven and take it to the serving table. However, with larger, denser food, the standing time may be as long as 10 minutes.

continued on next page

COOKING GUIDE

Microwave cooking tips (cont.)

Arranging food

For best results, place food evenly on the plate. You can do this in several ways:

- **If you are cooking several items of the same food**, such as baked potatoes, **place** them in a ring pattern for uniform cooking.
- **When cooking foods of uneven shapes or thickness, such as chicken breasts**, **place** the smaller or thinner area of the food towards the center of the dish where it will be heated last.
- **Layer thin slices of meat** on top of each other.
- **When you cook or reheat whole fish**, **score** the skin – this prevents cracking.
- **Do not** let food or a container touch the top or sides of the oven. This will prevent possible arcing.

Using aluminum foil

Metal containers should not be used in a microwave oven. There are, however, some exceptions. If you have purchased food which is prepackaged in an aluminum foil container, refer to the instructions on the package. When using aluminum foil containers, cooking times may be longer because microwaves will only penetrate the top of the food.

If you use aluminum containers without package instructions, follow these guidelines:

- **Place** the container in a glass bowl and add some water so that it covers the bottom of the container, not more than ¼ inch high. This ensures even heating of the container bottom.
- **Always remove** the lid to avoid damage to the oven.
- **Use only** undamaged containers.
- **Do not use** containers taller than ¾ inch.
- **Container must be** at least half filled.
- **To avoid arcing**, there must be a minimum ¼ inch between the aluminum container and the walls of the oven and also between two aluminum containers.
- **Always place** the container on the turntable.
- **Reheating food** in aluminum foil containers usually takes up to double the time compared to reheating in plastic, glass, china, or paper containers. The time when food is ready will vary depending upon the type of container you use.
- **Let food stand** for 2 to 3 minutes after heating so that heat is spread evenly throughout container.

Cooking you should not do in your microwave oven

- **Do not** do canning of foods in the oven. Closed glass jars may explode, resulting in damage to the oven or possible personal injury.
- **Do not** use the microwave oven to sterilize objects (baby bottles, etc.). It is difficult to keep the oven at the high temperature needed for safe sterilization.

QUESTIONS AND ANSWERS

QUESTIONS	ANSWERS
Can I operate my microwave oven without the turntable or turn the turntable over to hold a large dish?	No. If you remove or turn over the turntable, you will get poor cooking results. Dishes used in your oven must fit on the turntable.
Can I use a rack in my microwave oven so that I may reheat or cook on two levels at a time?	You can use a rack only if the rack is supplied with your microwave oven. If you use a rack not supplied with the microwave oven, you can get poor cooking performance and/or arcing.
Can I use either metal or aluminum pans in my microwave oven?	You can use aluminum foil for shielding (use small, flat pieces), small skewers, and shallow foil trays (if tray is not taller than $\frac{3}{4}$ inch deep and half filled with food to absorb microwave energy). Never allow metal to touch walls or door. (For more information, see "Using aluminum foil" in the "Cooking Guide" section.)
Is it normal for the turntable to turn in either direction?	Yes. The turntable rotates clockwise or counter-clockwise, depending on the rotation of the motor when the cooking cycle begins.
Sometimes the door of my microwave oven appears wavy. Is this normal?	This appearance is normal and does not affect the operation of your oven.
What are the humming noises that I hear when my microwave oven is operating?	You may hear the sound of the transformer when the magnetron tube cycles on.
Why does the dish become hot when I microwave food in it? I thought that this should not happen.	As the food becomes hot it will conduct the heat to the dish. Be prepared to use hot pads to remove food after cooking.
What does "standing time" mean?	"Standing time" means that food should be removed from the oven and covered for additional time to allow it to finish cooking. This frees the oven for other cooking.
Why does steam come out of the air exhaust vent?	Steam is normally produced during cooking. The microwave oven has been designed to vent this steam out the vent.
Can I pop popcorn in my microwave oven? How do I get the best results?	Yes. Pop packaged microwave popcorn following manufacturer's guidelines or use the preset AUTO SENSOR POPCORN pad. Do not use regular paper bags. Use the "listening test" by stopping the oven as soon as the popping slows to a "pop" every 1 or 2 seconds. Do not repop unpopped kernels. Do not pop popcorn in glass cookware.

TROUBLESHOOTING

Most cooking problems often are caused by little things you can find and fix without tools of any kind. Check the lists below and on the next page before calling for assistance or service. If you still need help, see the "Requesting Assistance or Service" on page 42.

Microwave oven does not work

PROBLEM	CAUSE
Nothing works.	<ul style="list-style-type: none">• The power supply cord is not plugged into a live circuit with the proper voltage. (See the "Electrical requirements" on page 6 and "Electrical connection" on page 11.)• A household fuse has blown or a circuit breaker has tripped.• The electric company has had a power failure.
The microwave oven will not run.	<ul style="list-style-type: none">• You are using the oven as a timer. Touch CANCEL/OFF to cancel the Minute Timer.• The door is not firmly closed and latched.• You did not touch START.• You did not follow directions exactly.• An operation that you set earlier is still running. Touch CANCEL/OFF to cancel that operation.

Cooking times

PROBLEM	CAUSE
Food is not cooked enough.	<ul style="list-style-type: none">• The electric supply to your home or wall outlets is low or lower than normal. Your electric company can tell you if the line voltage is low. Your electrician or service technician can tell you if the outlet voltage is low.• The cook power is not at the recommended setting. Check the "Microwave cooking chart" on pages 32-36.• You have not allowed enough cooking time for the amount of food being cooked. Larger amounts of food need longer cooking times.
The display shows a time counting down but the oven is not cooking.	<ul style="list-style-type: none">• You have set the controls as a Minute Timer. Touch CANCEL/OFF to cancel the Minute Timer.

TROUBLESHOOTING

Turntable

PROBLEM	CAUSE
The turntable will not turn.	<ul style="list-style-type: none">• The turntable is not correctly in place. It should be correct-side up.• The support is not operating correctly. Remove the turntable and restart the oven. If the support still does not move, call an authorized service technician for repair. Cooking without the turntable can give you poor results.

Tones

PROBLEM	CAUSE
You do not hear the programming or end-of-cycle tone.	<ul style="list-style-type: none">• You have not entered the correct command.

Fan problems

PROBLEM	CAUSE
The fan seems to be running slower than usual.	<ul style="list-style-type: none">• The oven has been stored in a cold area. The fan will run slower until the oven warms up to normal room temperature.

Display messages

PROBLEM	CAUSE
The display is scrolling "PLEASE SET TIME OF DAY".	<ul style="list-style-type: none">• There has been a power interruption. Reset the clock. (See the "Setting the clock" on page 15.)

If none of these items are causing your problem, see "Requesting Assistance or Service" on page 42.

REQUESTING ASSISTANCE OR SERVICE

To avoid unnecessary service calls, please check the "Troubleshooting" section. It may save you the cost of a service call. If you still need help, follow the instructions below.

If you need assistance or service

Call the KitchenAid Consumer Assistance



Center toll free at
1-800-422-1230.

When calling:

Please provide KitchenAid with the purchase date, and the complete model and serial number of your appliance (see the "A Note to You" section). This information will help us better respond to your request.

Our consultants provide assistance with:

- Features and specifications on our full line of appliances
- Installation information

- Use and maintenance procedures
- Accessory and repair parts sales
- Specialized customer assistance (Spanish speaking, hearing impaired, limited vision, etc.)
- Referrals to local dealers, service companies, and repair parts distributors

KitchenAid service technicians are trained to fulfill the product warranty and provide after-warranty service anywhere in the United States.

To locate the authorized KitchenAid service company in your area, you can also look in your telephone directory Yellow Pages.

For further assistance

If you need further assistance, you can write to KitchenAid with any questions or concerns at:

KitchenAid Brand Home Appliances
Consumer Assistance Center
c/o Correspondence Dept.
2000 North M-63
Benton Harbor, MI 49022-2692

Please include a daytime phone number in your correspondence.

INDEX

This index is alphabetical. It contains all the topics included in this manual, along with the page(s) on which you can find each topic.

TOPIC	PAGE	TOPIC	PAGE
ALUMINUM FOIL	38	GROUNDING INSTRUCTIONS	6
AUDIBLE SIGNALS	14	HOW YOUR MICROWAVE OVEN WORKS	7, 8
BUILT-IN KITS	15	INSTALLATION INSTRUCTIONS	5, 6
CARING FOR YOUR MICROWAVE OVEN	30	PARTS AND FEATURES	
CHARTS		Cooking guide label	12
Auto sensor cook	27	Door open button	12
Custom cook	22	Door safety lock system	12
Custom defrost	24	Light	12
Microwave cooking	32	Magnetron	7, 39
Reheating	31	Model and serial number plate	12
CONTROL PANEL	13, 14	Turntable	7, 11, 12, 30, 39
Audible signals	14	Vents (exhaust & air intake openings)	5
AUTO SENSOR COOK	27	Window	12
AUTO SENSOR POPCORN	29	QUESTIONS AND ANSWERS	39
AUTO SENSOR REHEAT	29	RACK	39
CANCEL/OFF	13	RADIO INTERFERENCE	9
Child lock	14	REQUESTING ASSISTANCE OR SERVICE	42
CUSTOM COOK	22	SAFETY	3-4, 10-11
CUSTOM DEFROST	23	STANDING TIME	29, 37, 39
Clock set	15	TESTING YOUR DINNERWARE	
Cooking at different cook powers	19	OR COOKWARE	10
Cooking at high cook power	18	TESTING YOUR MICROWAVE OVEN	9
Cook power	18, 19, 20	TIPS	
Cook time	18, 20	Cooking	37
EASY MINUTE	17	Defrosting	26
Interrupting cooking	14	TROUBLESHOOTING	40-41
Minute timer	16	WARRANTY	44
Number pads	13		
START	13		
ERROR SIGNALS	14		

COUNTERTOP MICROWAVE OVEN WARRANTY

LENGTH OF WARRANTY:	KITCHENAID WILL PAY FOR:	KITCHENAID WILL NOT PAY FOR:
ONE-YEAR FULL WARRANTY FROM DATE OF PURCHASE	Replacement parts and repair labor costs to correct defects in materials or workmanship. Service must be provided by an authorized KitchenAid servicing outlet.	A. Service calls to: 1. Correct the installation of the oven. 2. Instruct you how to use the oven. 3. Replace house fuses or correct house wiring. B. Repairs when oven is used in other than normal home use. C. Damage resulting from accident, alteration, misuse, abuse, fire, flood, acts of God, improper installation, or installation not in accordance with local electrical codes. D. Any labor costs during the limited warranty. E. Replacement parts or repair labor costs for units operated outside the United States. F. In-home service. Your microwave oven must be taken to an authorized KitchenAid service company, except when your microwave oven is installed over an approved KitchenAid oven using an approved built-in kit. (See "Built-in kits" in the "Getting to Know" section for a list of approved built-in kits.) G. Repairs to parts or systems resulting from unauthorized modifications made to the appliance.
SECOND-THROUGH FIFTH-YEAR LIMITED WARRANTY FROM DATE OF PURCHASE	Replacement of magnetron tube to correct defects in materials or workmanship.	

12/97

KITCHENAID DOES NOT ASSUME ANY RESPONSIBILITY FOR INCIDENTAL OR CONSEQUENTIAL DAMAGES. Some states do not allow the exclusion or limitation of incidental or consequential damages, so this exclusion or limitation may not apply to you. This warranty gives you specific legal rights and you may also have other rights which may vary from state to state.

Outside the United States, a different warranty may apply. For details, please contact your authorized KitchenAid dealer.

If you need service, first see the "Troubleshooting" section of this book. After checking "Troubleshooting," additional help can be found by checking the "Requesting Assistance or Service" section or by calling our Consumer Assistance Center telephone number, **1-800-422-1230**, from anywhere in the U.S.A.