

KitchenAid®

ULTIMA COOK™ SPEED OVEN

Use & Care Guide

For questions about features, operation/performance, parts accessories or service, call: **1-800-422-1230**

www.kitchenaid.com

Table of Contents 2



TABLE OF CONTENTS

MICROWAVE OVEN SAFETY	3
Electrical Requirements	5
PARTS AND FEATURES	5
Oven Cavity Coating	5
Microwave System.....	5
Turntable	6
Cooking Rack.....	6
Browning Pan and Handle	6
Grill Rack	7
OVEN CONTROL	7
Display/Touch Screen.....	7
Progress Bar.....	8
Start	8
Off/Cancel	8
Clock	8
Tones.....	9
Timer.....	9
Vent Fan	9
Cooktop/Countertop Light.....	9
Hints & Settings.....	9
Child Lock	10
Night Light.....	10
Display Brightness and Contrast	10
Learning Mode	10
Demo Mode.....	10
MICROWAVE OVEN USE	11
Food Characteristics	11
Cooking Guidelines	11
Cookware and Dinnerware	11
Aluminum Foil and Metal	12
Cooking Power.....	12
Cooking	13
Doneness	13
Prepare.....	13
Preset Cooking.....	13
Popcorn	14
Cooking in Stages.....	14
Reheating	14
Defrosting	15
Baked Goods	15
Grill	16
Boil & Simmer.....	17
Browning Pan Feature	18
Soften and Melt.....	19
Keep Warm.....	19
OVEN CARE	20
General Cleaning.....	20
Replacing Filters.....	21
Replacing Cooktop Light	21
Replacing Oven Light.....	21
TROUBLESHOOTING	22
ASSISTANCE OR SERVICE.....	23
Replacement Parts.....	23
WARRANTY	24

MICROWAVE OVEN SAFETY

Your safety and the safety of others are very important.

We have provided many important safety messages in this manual and on your appliance. Always read and obey all safety messages.



This is the safety alert symbol.

This symbol alerts you to potential hazards that can kill or hurt you and others.

All safety messages will follow the safety alert symbol and either the word "DANGER" or "WARNING." These words mean:

! DANGER

You can be killed or seriously injured if you don't immediately follow instructions.

! WARNING

You can be killed or seriously injured if you don't follow instructions.

All safety messages will tell you what the potential hazard is, tell you how to reduce the chance of injury, and tell you what can happen if the instructions are not followed.

IMPORTANT SAFETY INSTRUCTIONS

When using electrical appliances basic safety precautions should be followed, including the following:

WARNING: To reduce the risk of burns, electric shock, fire, injury to persons, or exposure to excessive microwave energy:

- Read all instructions before using the microwave oven.
- Read and follow the specific "PRECAUTIONS TO AVOID POSSIBLE EXPOSURE TO EXCESSIVE MICROWAVE ENERGY" found in this section.
- The microwave oven must be grounded. Connect only to properly grounded outlet. See "GROUNDING INSTRUCTIONS" found in this section and in the provided Installation Instructions.
- Install or locate the microwave oven only in accordance with the provided Installation Instructions.
- Some products such as whole eggs in the shell and sealed containers – for example, closed glass jars – are able to explode and should not be heated in the microwave oven.
- Use the microwave oven only for its intended use as described in this manual. Do not use corrosive chemicals or vapors in the microwave oven. This type of oven is specifically designed to heat, cook, or dry food. It is not designed for industrial or laboratory use.
- As with any appliance, close supervision is necessary when used by children.
- Do not operate the microwave oven if it has a damaged cord or plug, if it is not working properly, or if it has been damaged or dropped.
- The microwave oven should be serviced only by qualified service personnel. Call an authorized service company for examination, repair, or adjustment.
- See door surface cleaning instructions in the "Microwave Oven Care" section.
- To reduce the risk of fire in the oven cavity:
 - Do not overcook food. Carefully attend the microwave oven when paper, plastic, or other combustible materials are placed inside the oven to facilitate cooking.
 - Remove wire twist-ties from paper or plastic bags before placing bags in oven.
 - If materials inside the oven ignite, keep oven door closed, turn oven off, and disconnect the power cord, or shut off power at the fuse or circuit breaker panel.
 - Do not use the cavity for storage purposes. Do not leave paper products, cooking utensils, or food in the cavity when not in use.

SAVE THESE INSTRUCTIONS

IMPORTANT SAFETY INSTRUCTIONS

- Liquids, such as water, coffee, or tea are able to be overheated beyond the boiling point without appearing to be boiling. Visible bubbling or boiling when the container is removed from the microwave oven is not always present. **THIS COULD RESULT IN VERY HOT LIQUIDS SUDDENLY BOILING OVER WHEN THE CONTAINER IS DISTURBED OR A SPOON OR OTHER UTENSIL IS INSERTED INTO THE LIQUID.**
To reduce the risk of injury to persons:
 - Do not overheat the liquid.
 - Stir the liquid both before and halfway through heating it.
 - Do not use straight-sided containers with narrow necks.
 - After heating, allow the container to stand in the microwave oven for a short time before removing the container.
 - Use extreme care when inserting a spoon or other utensil into the container.
- Suitable for use above both gas and electric cooking equipment.
- Intended to be used above ranges with maximum width of 36 inches.
- Clean Ventilating Hoods Frequently - Grease should not be allowed to accumulate on hood or filter.
- Oversized foods or oversized metal utensils should not be inserted in the microwave oven as they may create a fire or risk of electric shock.
- Do not clean with metal scouring pads. Pieces can burn off the pad and touch electrical parts involving a risk of electric shock.
- Do not use paper products when appliance is operated in the “PAN BROWN” mode (on models with this feature).
- Do not store any materials, other than manufacturer’s recommended accessories, in this oven when not in use.
- Do not store anything directly on top of the microwave oven when the microwave oven is in operation.
- When flaming foods under the hood, turn the fan on.
- Use care when cleaning the vent-hood filter. Corrosive cleaning agents, such as lye-based oven cleaners, may damage the filter.
- Do not cover or block any openings on the microwave oven.
- Do not store this microwave oven outdoors. Do not use the microwave oven near water - for example, near a kitchen sink, in a wet basement, or near a swimming pool, or similar locations.
- Do not immerse cord or plug in water.
- Keep cord away from heated surfaces.
- Do not let cord hang over edge of table or counter.
- Do not mount over a sink.
- Do not cover racks or any other part of the oven with metal foil. This will cause overheating of the oven.

SAVE THESE INSTRUCTIONS

PRECAUTIONS TO AVOID POSSIBLE EXPOSURE TO EXCESSIVE MICROWAVE ENERGY

- (a) Do not attempt to operate this oven with the door open since open-door operation can result in harmful exposure to microwave energy. It is important not to defeat or tamper with the safety interlocks.
- (b) Do not place any object between the oven front face and the door or allow soil or cleaner residue to accumulate on sealing surfaces.
- (c) Do not operate the oven if it is damaged. It is particularly important that the oven door close properly and that there is no damage to the:
 - (1) Door (bent),
 - (2) Hinges and latches (broken or loosened),
 - (3) Door seals and sealing surfaces.
- (d) The oven should not be adjusted or repaired by anyone except properly qualified service personnel.

Electrical Requirements

⚠ WARNING



Electrical Shock Hazard

Plug into a grounded 3 prong outlet.

Do not remove ground prong.

Do not use an adapter.

Do not use an extension cord.

Failure to follow these instructions can result in death, fire, or electrical shock.

Observe all governing codes and ordinances. A 120 Volt, 60 Hz, AC only, 15- or 20-amp fused electrical supply is required. (A time-delay fuse or circuit breaker is recommended.) It is recommended that a separate circuit serving only this appliance be provided.

GROUNDING INSTRUCTIONS

■ **For all cord connected appliances:**

The microwave oven must be grounded. In the event of an electrical short circuit, grounding reduces the risk of electric shock by providing an escape wire for the electric current. The microwave oven is equipped with a cord having a grounding wire with a grounding plug. The plug must be plugged into an outlet that is properly installed and grounded.

WARNING: Improper use of the grounding plug can result in a risk of electric shock. Consult a qualified electrician or serviceman if the grounding instructions are not completely understood, or if doubt exists as to whether the microwave oven is properly grounded.

Do not use an extension cord. If the power supply cord is too short, have a qualified electrician or serviceman install an outlet near the microwave oven.

■ **For a permanently connected appliance:**

This appliance must be connected to a grounded, metallic, permanent wiring system, or an equipment grounding conductor should be run with the circuit conductors and connected to the equipment grounding terminal or lead on the appliance.

SAVE THESE INSTRUCTIONS

This device complies with Part 18 of the FCC Rules.

PARTS AND FEATURES

This manual may cover several different models. The model you have purchased may have some or all of the features shown here. The appearance of your particular model may differ slightly from the illustrations in this manual.

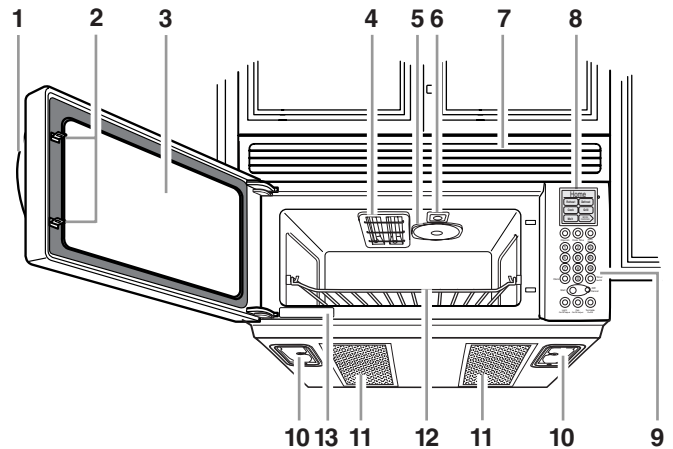

1. Door Handle

2. Door Safety Lock System

3. Metal-Shielded Window

4. Grill Element

5. Microwave Inlet Cover

6. Oven Light

7. Vent Grille

8. Touch Screen Display

9. Control Buttons

10. Cooktop Lights

11. Grease and Charcoal Filters

12. Cooking Rack

13. Model and Serial Number Plate

Parts and Features Not Shown

Turntable

Grill Rack

Browning Pan and Handle

Oven Cavity Coating

The oven has a durable, nonstick coating which resists soil buildup by making cleaning easier than in conventional microwave ovens. For cleaning information, see "General Cleaning" in the "Oven Care" section.

Microwave System

The microwave system delivers a constant stream of microwave power – true high, medium and low power.

Typically, microwave ovens operate on HIGH power only. For example, to achieve a 50% power level ("medium") in a typical microwave oven, the oven operates 50% of the time at HIGH power and 50% of the time OFF.

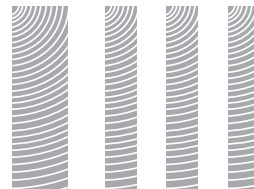

In contrast, microwave ovens utilizing this microwave system deliver the selected power level continuously. This constant stream of microwave power helps to minimize overcooking of foods and messy food spatters.



Additionally, the oven uses a 1,000-watt halogen bulb with a 500-watt quartz bulb together to serve as the grill element for various cooking functions. When this element is in use, it produces a bright light in the oven cavity, and causes the cavity and door to become hot. The use of oven mitts is recommended.

Sensor Cooking

The microwave system features sensor cooking functions. A humidity sensor in the oven cavity detects moisture and humidity emitted from food as it heats. The sensor adjusts cooking times to various types and amounts of food. Sensor cooking takes the guesswork out of microwave cooking.

Turntable

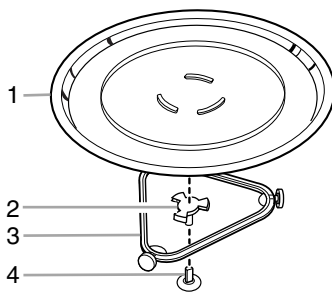

1. Turntable
2. Hub
3. Support
4. Shaft

The turntable can rotate in either direction to help cook food more evenly. Do not operate the oven without the turntable in place. See "Assistance or Service" to reorder any of the parts.

To Install:

1. Remove tape from the hub.
2. Place the support on the oven cavity bottom.
3. Place the turntable on the support.

Fit the raised, curved lines in the center of the turntable bottom between the three spokes of the hub. The rollers on the support should fit inside the turntable bottom ridge.

To Turn Off:

The turntable can be turned off (except during an auto function). This is helpful when cooking with plates that are larger than the turntable or when cooking with two 10¼ in. (26 cm) plates that are side by side.

To Turn Off: Press TURNTABLE ON/OFF button.

"TURNTABLE OFF" will appear in the display. The turntable will turn back on automatically when cooking is over or when OFF/CANCEL is pressed.

Cooking Rack

The rectangular cooking rack is ideal for two-level cooking. It provides extra cavity space for cooking 2 or more containers at the same time. Insert the rack securely into the rack supports on the side walls of the oven. See "Assistance or Service" to order replacement parts.

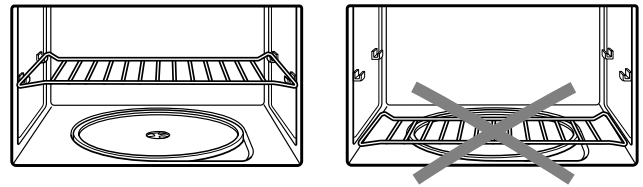

- Rack will become hot. Always use oven mitts or pot holders when handling.
- Do not allow the rack to touch the inside cavity walls, ceiling or floor.
- Do not use metal cookware, utensils, or a browning dish with the rack.
- Do not let food container on rack touch the top or sides of the oven.
- Do not use Browning Pan on rack.
- Remove rack before using Grill function.
- Remove rack before using Popcorn function.
- The rack is designed specifically for this oven. Do not use it in any other oven.
- Do not cook food directly on the rack. Always use a microwave-safe container.
- Use the rack only when cooking on 2 levels. Do not store it in the oven. Damage to the oven could result if someone accidentally turns on the oven.

Browning Pan and Handle

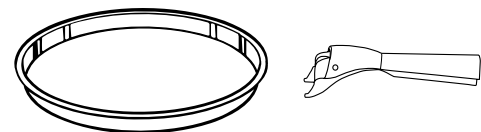

The Browning Pan, with a nonstick surface and detachable handle, has been specially designed for microwave use, and is ideal for pan-frying (pan-browning) foods in the microwave oven. The Browning Pan is also used as a drip pan for grilling.

Use the handle to grasp the pan. Place gripping end on the edge of pan, squeeze handle and lift pan.

See "Assistance or Service" to order replacement parts.

Grill Rack

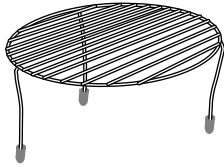

The circular grill rack is for grilling in the microwave oven. Place the grill rack securely on Browning Pan, the Browning Pan on the turntable, and position food on grill rack. See “Assistance or Service” to order replacement parts.

OVEN CONTROL

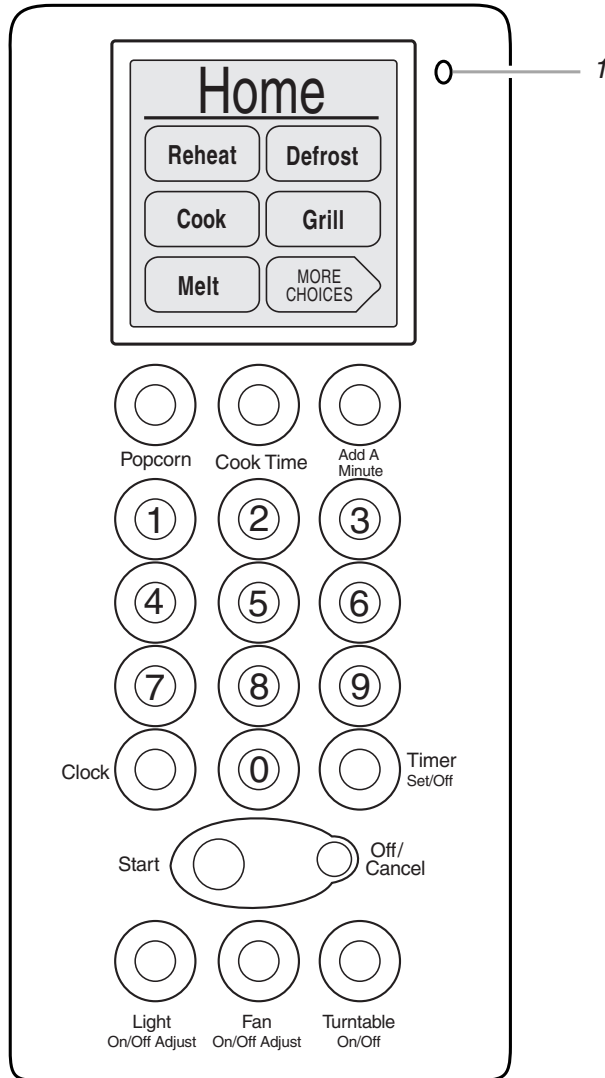

1. Light Sensor

Display/Touch Screen

The display/touch screen functions as both a display and a menu-driven touch screen control.

Display

The display screen shows the time of day and Home screen when the microwave oven is not in use. If the time of day is hidden (see “Clock” section), “Home” will appear in its place.

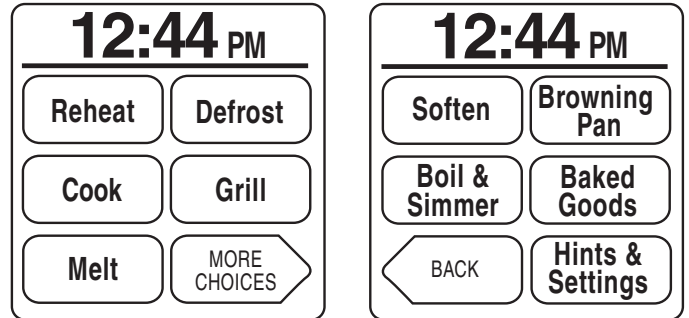

During programming, the display screen displays function menus, servings and weights, preparation instructions, and cooking time/power settings. During a cooking cycle, it counts down the remaining time, and gives prompts to stir or turn food.

Touch Screen

The LCD touch screen is used to input commands. A light- to medium-pressure touch of the fingertip will activate the menu choice. However, sensitivity of the touch screen may vary, and using the tips or backs of fingernails may provide more accuracy when inputting commands.

The following illustrates how the Touch Screen display screens help the navigation through menus. This example shows the display screens and selections when cooking chicken pieces.

1. From Home screen, touch “Cook.” Display shows:

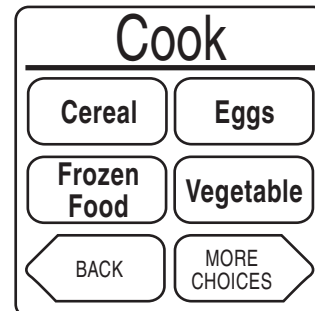

2. Touch “More Choices.” Display shows:

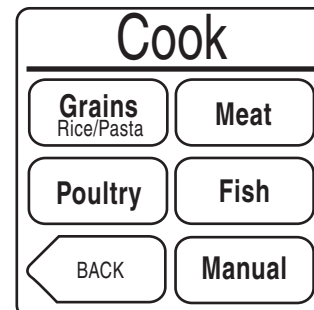

3. Touch "Poultry." Display shows:

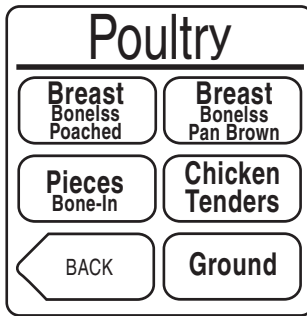

4. Touch "Pieces, Bone-In." Use number pads to enter weight. Display shows:

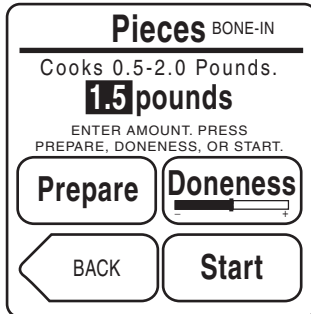

5. Touch "Doneness" if desired. (See "Doneness" in the "Oven Use" section.) Display shows:

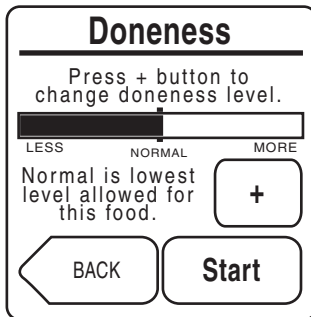

6. Touch "Start." While cooking, Display shows:



When cooking is over, display shows:



See "Learning Mode" section to see how to practice navigating through the menus without turning on the microwave generator. See "Display Brightness and Contrast" section to see how to adjust display settings.

Progress Bar

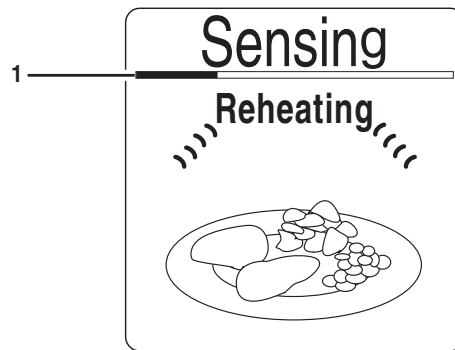

1. Progress bar

The progress bar is a visual picture of the estimated running time of a cooking cycle. It will appear during sensor cooking functions. The line appears below the word "Sensing," and shows progress by the darkening of the line from the left. After the sensor is finished sensing, the remaining cook time replaces the word "Sensing" at the top of the display, but the progress bar continues to be displayed.

Start

The START button will start any function.

If non-sensor cooking is interrupted, touching START will resume the preset cycle.

For added convenience, the "Start" touch pad is also available on some display screens, and provides the same function as the START control button.

Off/Cancel

The OFF/CANCEL button clears any incorrect command and cancels most functions except for the Timer, Child Lock and Learning Mode. It will not erase the time of day.

The oven will also turn off when the door is opened. Close the door and press the START button or touch "Continue" on the display screen to resume the cycle. A sensor cooking cycle may not be resumed if interrupted by opening the door.

Clock

This is a 12-hour clock, showing a.m. and p.m. When power is first supplied to the oven, or after a power failure, the "Home" screen will appear.

To Set Clock: Press CLOCK, and follow directions.

To Hide Clock: Press CLOCK, then press OFF/CANCEL. "Home" will appear in place of the time of day on display screen.

To Display Clock: Press CLOCK, then press START.

Tones

Tones are audible signals, indicating the following:

One tone

- Valid entry (short beep)
- End of Timer countdown (long tone)

Two tones

- Reminder (short beeps), repeat each minute for 15 minutes after the end-of-cycle tones
- Between stages (short beeps)

Three Tones

- Invalid entry (short beeps)

Four tones

- End of cycle (long tones)

To Disable Tones: Turn volume off using the “Hints & Settings” menu.

Timer

The Timer can be set in minutes and seconds, up to 90 minutes, and counts down the set time. The Timer does not start or stop the oven.

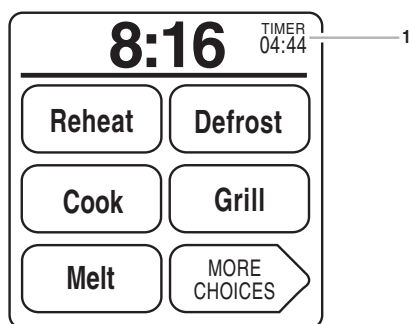

1. Timer countdown

When the Timer is in use, the oven can still operate. During an oven operation, “Timer” will appear in the upper, right-hand corner of the display. The countdown may also be seen by pressing TIMER SET/OFF. Touch “Return” to go back to the previous screen or wait until the timer ends. If the timer ends while oven is still operating, the tone will sound and the display will return to the set operating mode.

To Set: Press TIMER SET/OFF, enter desired time and touch “Start.” The time can be reset during the countdown by pressing TIMER SET/OFF, entering a new time, then pressing START.

To Cancel: Press TIMER SET/OFF twice.

Vent Fan

The vent fan has 4 speeds ranging from Off to High.

To protect the oven, the fan will automatically turn on at high speed if the temperature from the range or cooktop below gets too hot. It may stay on for up to 1 hour to cool the oven. When this occurs, the Fan button will not function.

- A few seconds after the last time the Fan button is pressed, the screen returns to the previous display.
- The first time the vent fan is turned on after power is connected to the oven, the fan will start at high speed. The next time the vent fan is turned on, it will start at the last speed used.

To Turn Fan On/Off: Press the Fan button to turn fan on, then touch “+” or “-” on the display screen to select fan speed. Press the Fan button twice to turn the fan off (or once if the Fan screen is active).

Cooktop/Countertop Light

The cooktop/countertop light has numerous brightness settings ranging from Off to High. The light can be turned on manually, or the Night Light can be programmed to come on automatically when the sensor detects low light level.

To Manually Turn Light On/Off: Press the Light button to turn light on. Touch “+” or “-” on the display screen to set desired brightness level. Press the Light button twice to turn light off (or once if the Light screen is active).

Hints & Settings

Functions can be selected, and displays can be changed by using the Hints & Settings menu.

Option	Setting
Child Lock	Turn on or off.
Display Brightness	Set at full, or reduced or off after 2 minutes of inactivity. See “Display Brightness and Contrast” section.
Keep Warm	Adjust time, if desired and start.
Display Contrast	Set from MIN to MAX.
Hints	Choose from Cleaning, Food, Power (level), Methods (cooking) or Cookware.
Night Light	Turn on or off, and set room light level detection. See “Night Light” section.
Learning Mode	Turn on or off. See “Learning Mode” section.
Demo Mode	Turn on. See “Demo Mode” section.
Volume	Set from OFF to MAX.

1. On “Home” screen, touch “More Choices.”
2. Touch “Hints & Settings.”
3. Touch desired category (touch “More Choices” for more categories), and choose settings.

Child Lock

The Child Lock disables all cooking function controls to prevent unintended use of the oven.

The timer, clock, cooktop light, exhaust fan, and some settings may still be used while the Child Lock is on.



Display with padlock in upper, left-hand corner. Child Lock active.

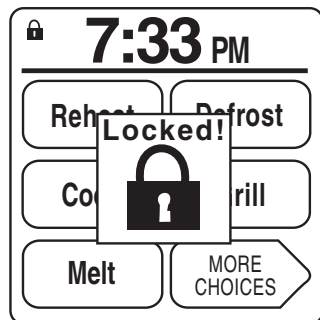

Display when attempt is made to use oven. Child Lock active.

To Activate Child Lock:

The oven must be off.

1. On "Home" screen, touch "More Choices."
2. Touch "Hints & Settings."
3. Touch "Child Lock."
4. Touch "On/Off" to set lock, then touch "Finished."
"Locked!" and a padlock icon will appear in the display screen if any attempt is made to start the oven. As long as the Child Lock is activated, a lock icon will appear and remain in the upper, left-hand corner of the "Home" screen.

Repeat to deactivate Child Lock.

Night Light

The Night Light can be programmed to automatically come on when low light levels are detected.

To Set the Sensor for Night Light:

1. On the "Home" screen, touch "More Choices."
2. Touch "Hints & Settings."
3. Touch "More Choices."
4. Touch "Night Light."
5. On the "Night Light" screen, touch "Set/Off" to set Night Light, then touch "Set Level."
6. On the "Set Level" screen, touch "+" or "-" to set desired Night Light activation level.
The display will show the current room light level as well as the activation level setting. The current room light level will fluctuate based upon current light conditions.
7. Touch "Finished."

Display Brightness and Contrast

The display brightness and contrast may be adjusted to improve display visibility.

Display brightness can be set at full (display backlight is on), reduced (backlight is low and the screen is dim but still visible) or off (display is completely dark) after 2 minutes of inactivity.

Display contrast may be set from MIN to MAX.

To Set Display Brightness or Contrast:

1. On "Home" screen, touch "More Choices."
2. Touch "Hints & Settings."
3. Touch "Display Contrast" or "Display Brightness," and follow directions to set desired levels.

Learning Mode

The Learning Mode is ideal for learning how to use the oven. When set, functions can be entered, with real displays and tones, without actually turning on the microwave generator or grill element. While functions are operating in the Learning Mode, the oven light will come on, the fan will run, and the turntable will rotate (if set ON).

While the Learning Mode is active, the book icon will appear in the upper, left-hand corner of the display.



To Activate Learning Mode:

The oven must be off.

1. On "Home" screen, touch "More Choices."
2. Touch "Hints & Settings."
3. Touch "More Choices."
4. Touch "Learning Mode."
5. Touch "On/Off" to set.
6. Touch "Finished."

Repeat to deactivate Learning Mode.

Demo Mode

The Demo Mode demonstrates the features and capabilities of the oven on the display screen.

To Activate Demo Mode:

1. On the "Home" screen, touch "More Choices."
2. Touch "Hints & Settings."
3. Touch "More Choices."
4. Touch "Demo Mode."
5. Touch "Start."

To deactivate Demo Mode, press OFF/CANCEL.

MICROWAVE OVEN USE

A magnetron in the oven produces microwaves which reflect off the metal floor, walls and ceiling and pass through the turntable and appropriate cookware to the food. Microwaves are attracted to and absorbed by fat, sugar and water molecules in the food, causing them to move, producing friction and heat which cooks the food.

- Never lean on or allow children to swing on the oven door.
- Do not operate microwave oven when it is empty.
- The turntable must be in place and correct side up when oven is in use. Do not use if turntable is chipped or broken. See “Assistance or Service” section to reorder.
- Baby bottles and baby food jars should not be heated in the oven.
- Clothes, flowers, fruit, herbs, wood, gourds, paper, including brown paper bags and newspaper should not be dried in the oven.
- Do not use the microwave oven for canning, sterilizing or deep frying. The oven cannot maintain appropriate temperatures.
- Paraffin wax will not melt in the oven because it does not absorb microwaves.
- Use oven mitts or pot holders when removing containers from oven.
- Do not overcook potatoes. At the end of the recommended cook time, potatoes should be slightly firm. Let potatoes stand for 5 minutes. They will finish cooking while standing.
- Do not cook or reheat whole eggs inside the shell. Steam buildup in whole eggs may cause them to burst. Cover poached eggs and allow a standing time.

Food Characteristics

When microwave cooking, the amount, size and shape, starting temperature, composition and density of the food affect cooking results.

Amount of Food

The more food heated at once, the longer the cook time. Check for doneness and add small increments of time if necessary.

Size and Shape

Smaller pieces of food will cook more quickly than larger pieces, and uniformly shaped foods cook more evenly than irregularly shaped food.

Starting Temperature

Room temperature foods will heat faster than refrigerated foods, and refrigerated foods will heat faster than frozen foods.

Composition and Density

Foods high in fat and sugar will reach a higher temperature and heat faster than other foods. Heavy, dense foods, such as meat and potatoes, require a longer cook time than the same size of a light, porous food, such as cake.

Cooking Guidelines

Covering

Covering food helps retain moisture, shorten cook time and reduce spattering. Use the lid supplied with cookware. If a lid is not available, wax paper, paper towels or plastic wrap approved for microwave ovens may be used. Plastic wrap should be turned back at one corner to provide an opening to vent steam.

Stirring and Turning

Stirring and turning redistributes heat evenly to avoid overcooking the outer edges of food. Stir from outside to center. If possible, turn food over from bottom to top.

Arranging

If heating irregularly shaped or different sized foods, the thinner parts and smaller sizes should be arranged toward the center. If cooking several items of the same size and shape, place them in a ring pattern, leaving the center of the ring empty.

Piercing

Before heating, use a fork or small knife to pierce or prick foods that have a skin or membrane, such as potatoes, egg yolks, chicken livers, hot dogs, and sausage. Prick in several places to allow steam to vent.

Shielding

Use small, flat pieces of aluminum foil to shield the thin pieces of irregularly shaped foods, bones and foods such as chicken wings, leg tips and fish tail. See “Aluminum Foil and Metal” first.

Standing Time

Food will continue to cook by the natural conduction of heat even after the microwave cycle ends. The length of standing time depends on the volume and density of the food.

Cookware and Dinnerware

Cookware and dinnerware must fit on the turntable. Always use oven mitts or pot holders when handling because any dish may become hot from heat transferred from the food. Do not use cookware and dinnerware with gold or silver trim. Use the following chart as a guide, then test before using.

MATERIAL	RECOMMENDATIONS
Aluminum Foil, Metal	See “Aluminum Foil and Metal” section.
Browning Dish	Bottom must be at least $\frac{3}{16}$ in. (5 mm) above the turntable. Follow manufacturer’s recommendations.
Ceramic Glass, Glass	Acceptable for use.
China, Earthenware	Follow manufacturer’s recommendations.
Melamine	Follow manufacturer’s recommendations.

MATERIAL	RECOMMENDATIONS
Paper Towels, Dinnerware, Napkins	Use nonrecycled and those approved by the manufacturer for microwave oven use.
Plastic Wraps, Bags, Covers, Dinnerware, Containers	Use those approved by the manufacturer for microwave oven use.
Pottery and Clay	Follow manufacturer's recommendations.
Styrofoam*	Do not use in oven.
Straw, Wicker, Wooden Containers	Do not use in oven.
Wax Paper	Acceptable for use.

To Test Cookware or Dinnerware for Microwave Use:

- Put cookware or dinnerware in oven with 1 cup (250 mL) of water beside it.
- Cook at 100% cooking power for 1 minute.

Do not use cookware or dinnerware if it becomes hot and the water stays cool.

Aluminum Foil and Metal

Always use oven mitts or pot holders when removing dishes from the microwave oven.

Aluminum foil and some metal can be used in the oven. If not used properly, arcing (a blue flash of light) can occur and cause damage to the oven.

OK for Use

Racks and bakeware supplied with the oven (if supplied), aluminum foil for shielding, and approved meat thermometers may be used with the following guidelines:

- Never allow aluminum foil or metal to touch the inside cavity walls, ceiling or floor.
- Always use the turntable.
- Never allow contact with another metal object during cooking.

Do Not Use

Metal cookware and bakeware, gold, silver, pewter, non-approved meat thermometers, skewers, twist ties, foil liners such as sandwich wrappers, staples and objects with gold or silver trim or a metallic glaze should not be used in the oven.

For Use with Grill Element

When using the grill element for non-grill functions (without grill rack), use the provided pan or oven-proof cookware (glass or ceramic glass).

Cooking Power

Many recipes for microwave cooking specify which cooking power to use by percent, name or number. For example, 70%=7=Medium-High.

Use the following chart as a general guide for the suggested cooking power of specific foods.

PERCENT/ NAME	NUMBER	USE
100%, High (default setting)	10	Quick heating convenience foods and foods with high water content, such as soups, beverages and most vegetables.
90%	9	Cooking small tender pieces of meat, ground meat and poultry pieces. Heating cream soups.
80%	8	Heating rice, pasta or casseroles. Cooking and heating foods that need a cook power lower than high, such as meat loaf.
70%, Medium-High	7	Reheating a single serving of food. Cooking fish fillets.
60%	6	Cooking sensitive foods such as cheese and egg dishes, pudding and custards. Cooking nonstirtable casseroles, such as lasagna.
50%, Medium	5	Cooking ham, whole poultry, whole fish and pot roasts. Simmering stews.
40%	4	Heating bread, rolls and pastries.
30%, Medium-Low, Defrost	3	Defrosting bread, fish, meats, poultry and precooked foods.
20%	2	Melting chocolate, butter and marshmallows. Softening ice cream.
10%, Low	1	Taking chill out of fruit. Softening butter and cheese.

Cooking

To Use the Auto Cooking Functions:

When using preset cooking powers and cook times for selected food types (Cereal, Eggs, Frozen Food, Vegetable, Grains, Meat, Poultry, and Fish), follow the “Cook” menus to select amounts and begin the auto function. See “Display/Touch Screen” section for sample programming.

To Cook Manually:

1. Press COOK TIME.
2. Press number buttons to enter desired cook time.
If using a cooking power other than 100%, touch “Power,” then enter desired cooking power.
3. Press START.
Display will count down the cook time.

When the cooking cycle ends, the “End” screen will appear in the display, 4 end-of-cycle tones will sound, and then reminder tones will sound every minute for 15 minutes.
4. Press OFF/CANCEL or open the door to stop reminder tones and/or clear the display.

To Change Cook Time or Power During a Cooking Cycle:

Cook time and/or power may be changed after cooking begins without interrupting cooking.

1. Touch “Time” or “Power.”
 2. Enter new time or power.
 3. Press START.
-

Doneness

For many cooking functions, the screen displays a “Doneness” bar which can be adjusted by touching “+” or “-.” For most foods, the maximum and minimum doneness settings add to, or subtract from normal cook time.

For Defrost, the controlled percentage depends on food type and weight.

When doneness has been set for a specific food, the “Doneness” bar remembers that setting, and will remain at that setting for all future cooking cycles of that specific food, until it is reset.

Doneness control for Poultry, Pork, Fish, Hamburger and Steak can be set for no less than the default doneness.

Prepare

For many cooking functions, the “Prepare” screen is available. Touch “Prepare” for preparation instructions, as well as additional information about the food item, cookware, etc.

Preset Cooking

Times and cooking power have been preset for many common microwavable foods. Use the following chart as a guide.

CATEGORY	FOOD
Cereal	Instant (All Cereals), Oatmeal (Quick), Grits* (Regular), Grits* (Quick), Hot Wheat
Eggs	Fried**, Omelet**, Poached, Scrambled
Frozen Food	Entrées*, Entrées* (Family Size), Casserole, Pizza** (rising or thin crust), Chicken Nuggets**
Vegetable	Canned Fresh: Baked Potato*, Corn-on-the-Cob*, Green Beans*, Broccoli*, Asparagus*, Carrots*, Leafy Vegetable, Mushroom* (Portabella), Spinach* Frozen*
Grains*	Rice: White (Long Grain, Short Grain, Instant), Brown (Long Grain, Instant) Pasta: Fresh (Tortellini, Linguine, Ravioli), Dried (Spaghetti, Macaroni, Rotini, Penne, Fettuccine) Couscous, Grits (Regular), Grits (Quick)
Meat	Bacon**, Ground, Meat Balls**, Ham Steak**, Ham Slices**, Hamburger Patties**, Roast**, Sausages**
Poultry	Breast (Boneless - Poached), Breast** (Boneless - Pan Brown), Pieces (Bone-in), Chicken Tenders**, Ground
Fish	Fillet*, Steak**, Stick**

*Sensor function.

**Use Browning Pan.

To Use Preset Cooking:

1. On the “Home” screen, touch “Cook.”
2. Touch desired food category or “More Choices.”
3. Follow the menu screens to select the specific food item and quantity to be cooked.

The sensor will determine cook times for most Fresh Vegetables, Frozen Vegetables, Grains, Fish Fillets and Frozen Entrées.

Doneness may be adjusted at this time by touching “Doneness,” and then touching “+” or “-.”

Preparation instructions can be viewed for the specific food by touching “Prepare.”
4. Touch “Start” or press START button.
The display will count down the cook time.

When the cycle ends, the “End” screen will appear in the display, 4 end-of-cycle tones will sound, and then reminder tones will sound every minute.
5. Press OFF/CANCEL or open the door to clear the display and/or stop reminder tones.

Popcorn

Popcorn is a sensor function. The sensor determines the appropriate popping time of commercially packaged microwavable popcorn.

- Remove rectangular cooking rack before use.
- Do not use regular paper bags or glassware.
- Pop only 1 package of popcorn at a time.
- Follow manufacturer's instructions when using a microwave popcorn popper.
- Listen for popping to slow to 1 pop every 1 to 2 seconds, then stop the cycle. Do not repop unpopped kernels.
- Use fresh bags of popcorn for optimal results.
- Cooking results may vary by brand and fat content.

To Use Popcorn: Place popcorn bag on turntable. Press POPCORN. The oven starts the popping cycle automatically.

Cooking in Stages

The oven can be set to cook at different cooking powers for various lengths of time, up to 4 stages. Stage cooking can only be programmed in manual cook settings. Manual Defrost, Custom Grill or Manual Skillette may be used as the first stage, and then additional stages may be added as prompted.

- Oven cavity and door will become very hot during grill element use. The use of oven mitts is recommended.

To Cook in Stages:

1. Press COOK TIME.
2. Enter cook time in minutes and seconds for first stage.
3. Touch "Power," then enter the power level from the Cooking Power Chart.
4. Touch "Add a Stage."
5. Select what type of cooking will be done in the next stage by touching "Microwaves," "Grill," "Combi" (uses both microwaves and the grill element) or "Keep Warm."
6. Adjust cook time and power.
7. Touch "Enter."
8. Touch "Enter" to add another stage
or
Touch "Add a Stage" to program another stage, then repeat from step 5.

The cook time and power of the cycling stage may be changed without interrupting cooking by touching "Adjust Stage," changing the cook time and/or power and then touching "Okay."

Reheating

Times and cooking power have been preset for reheating 8 specific foods, plus manual.

FOOD TO BE REHEATED

Dinner Plates: 1 plate* of food, 2-4 plates of food

Beverage: 1 or 2 cups (250 or 500 mL)

Casserole: 1-4 cups (250 mL-1 L)

Pizza*: 1-3 slices

Muffin: Fresh or Frozen, 1-6 pieces

Roll: Fresh or Frozen, 1-6 pieces

Sauce*: Thin or Thick, 1-4 cups (250 mL-1 L)

Soup: Thin*, Thick* or Frozen, 1-4 cups (250 mL-1 L)

*Sensor function.

To Use:

1. On the "Home" screen, touch "Reheat."
2. Touch desired food category or "More Choices."
3. Follow the menu screens to select the specific food item and quantity to be cooked.

The sensor will determine reheat times for Dinner Plate, Pizza slices, Soups and Sauces.

Doneness may be adjusted at this time by touching "Doneness," and then touching "+" or "-."

4. Touch "Start" or press START button.
The display will count down the reheat time.

When the cycle ends, the "End" screen will appear in the display, 4 end-of-cycle tones will sound, and then reminder tones will sound every minute.

5. Press OFF/CANCEL or open the door to clear the display and/or stop reminder tones.

Two or More Plates

Two 10¼ in. (26 cm) plates may be heated side by side, or one dish larger than the turntable, plus 2 plates on the cooking rack. For best results, halfway through heating, turn the plates (or larger dish) halfway around, and switch plates between top and bottom (if heating more than 2 plates). See "Cooking Rack" section.

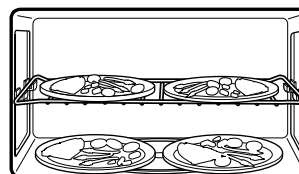

The turntable must be turned off while heating 2 bottom plates or one larger dish. See "Turntable" section.

Defrosting

The auto defrost feature has 3 categories: Meat, Poultry and Fish. It should not be used for food left outside the freezer more than 20 minutes and frozen ready-made food. The microwave oven can also be manually set to defrost.

- Food should be 0°F (-18°C) or colder at defrosting for optimal results. How foods are stored can affect results.
- Unwrap foods and remove lids (from fruit juice) before defrosting.
- Shallow packages will defrost more quickly than deep blocks.
- Separate food pieces as soon as possible during, or at the end of the cycle for more even defrosting.
- Use small pieces of aluminum foil to shield parts of food such as chicken wings, leg tips and fish tails. See “Aluminum Foil and Metal” section first.

To Use Auto Defrost:

1. Place food on turntable.
2. On the “Home” screen, touch “Defrost.”
3. Select food type.
4. Touch number pads to enter weight.
Meats and Poultry can be set from .1 to 6.5 lbs (45 g to 3 kg).
Fish can be set from .1 to 4.5 lbs (45 g to 2 kg).

If weight is not known, touch “Weight Unknown?” and follow the menu to determine approximate amount.

Doneness may be adjusted at this time by touching “Doneness,” and then touching “+” or “-.”
5. Touch “Start” or press START button.
The display will count down the defrost time.

When the cycle ends, the “End” screen will appear in the display, 4 end-of-cycle tones will sound, and then reminder tones will sound every minute.
6. Press OFF/CANCEL or open the door to clear the display and/or stop reminder tones.

To Use Manual Defrost:

1. On “Home” screen, touch “Defrost.”
 2. Touch “Manual.”
 3. Press number buttons to set defrost time.
 4. Press START.
The display will count down the defrost time.

When the cycle ends, the “End” screen will appear in the display, 4 end-of-cycle tones will sound, and then reminder tones will sound every minute.
 5. Press OFF/CANCEL or open the door to clear the display and/or stop reminder tones.
- Manual Defrost may be used as the first stage in stage cooking. See “Cooking in Stages” section.

Baked Goods

The oven has a baking function which uses the grill element in conjunction with the Browning Pan and microwaves. Times and cooking powers have been programmed for 5 baked goods settings.

- The oven cavity and door will become very hot during grill element use. The use of oven mitts is recommended.
- The Browning Pan will become very hot. Use oven mitts to remove pan from oven. Do not place hot Browning Pan directly on heat-sensitive surfaces. Damage may occur.
- Always use the Browning Pan to cook baked goods.
- Place Browning Pan directly on turntable. Never place Browning Pan on rectangular cooking rack.

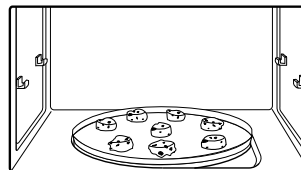

BAKED GOODS

Brownies: One 20 oz. (567 g) package

Cookies: 4, 6 or 8 cookies

Muffins: 4, 6 or 8 muffins

Biscuits*: Regular (5 or 10 biscuits) or Large (5 or 8 biscuits)

Rolls*: Regular (4 or 8 rolls) or Large (5 or 6 rolls)

*Requires preheating of Browning Pan.

To Use Baked Goods:

Some foods require preheating of the Browning Pan. See Baked Goods Chart.

1. Place food in Browning Pan (unless preheating is required), then place pan on turntable.
2. On “Home” screen, touch “More Choices.”
3. On “More Choices” screen, touch “Baked Goods.”
4. Select food item to be baked.
5. Press number buttons to enter amount to be baked.
Doneness may be adjusted at this time by touching “Doneness,” and then touching “+” or “-.”

Preparation instructions can be viewed for the specific food by touching “Prepare.”
6. Touch “Start” or press START button.

If preheating is required for the food, “Preheating Pan” will appear on the display. When Browning Pan is preheated, 2 short tones will sound, and “Place food in pan.” will appear on the display. Open door, place food in Browning Pan, close door and touch “Continue.”

If preheating is not required, the food will start cooking.

The display will count down the bake time.

When the cycle ends, the “End” screen will appear in the display, 4 end-of-cycle tones will sound, and then reminder tones will sound every minute.
7. Press OFF/CANCEL or open the door to clear the display and/or stop reminder tones.

Grill

The Grill function uses a 1,500-watt halogen and quartz element that heats quickly to grill a variety of foods.

- Oven cavity and door will become very hot during grill element use. The use of oven mitts is recommended.
- The circular grill rack and Browning Pan will become very hot. Use oven mitts to grasp Browning Pan for removal. Do not place hot Browning Pan directly on heat-sensitive surfaces. Damage may occur.
- Use the grill rack to place food closer to the Grill element for faster grilling.
- Remove rectangular cooking rack. Do not use the cooking rack to grill food.
- The turntable must be turned on when using the grill rack.
- Use the Browning Pan to catch drippings. Never place the Browning Pan on the grill rack or the cooking rack.
- Place grill rack securely on Browning Pan, and place both on the turntable. Then position food on rack.
- For best results, apply light amount of cooking oil to grill rack.
- While the Grill function is in use, the fan operates at a low speed automatically until the cycle is over.

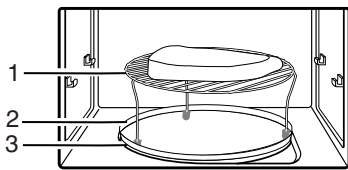

1. Grill Rack
2. Browning Pan
3. Turntable
(under Browning Pan)

FOOD TO BE GRILLED

Chicken Pieces, Bone-in: 1 or 2 pieces

Fish Steak: 1 or 2 steaks

Hamburger Patties: 2-4 patties

Steak: 1 steak, ½" (13 mm) thick

Chops: 1 or 2 chops

Shrimp: 5-8 oz (142-227 g)

Vegetable: Mushroom (1-3 servings); Onions (1 or 2 servings); Peppers (1 or 2 servings); Summer Squash (1 or 2 servings); Tomatoes (2 or 4 halves)

To Grill:

Before using, remove rectangular cooking rack from oven.

1. Place circular grill rack securely on Browning Pan, and place both on the turntable. Then position food on rack.
2. On "Home" screen, touch "Grill."
3. Select food item to be grilled or touch "Custom" (on "More Choices" screen) if grilling a food not on the menu. See "Custom Grill Chart."

Microwaves may be added to the custom grilling cycle.

4. Press number buttons to enter amount.
Doneness may be adjusted at this time by touching "Doneness," and then touching "+" or "-."

Preparation instructions can be viewed for the specific food by touching "Prepare."

5. Touch "Start" or press START button.
The display will count down the grill time.

When the cycle ends, the "End" screen will appear in the display, 4 end-of-cycle tones will sound, and then reminder tones will sound every minute.

6. Press OFF/CANCEL or open the door to clear the display and/or stop reminder tones.

Custom Grill may be used as the first stage in stage cooking. See "Cooking in Stages" section.

After Grilling

The food, circular grill rack, Browning Pan and oven cavity and door will be very hot. Using oven mitts, grasp the Browning Pan securely with both hands and remove it with grill rack and food in place.

Use the detachable handle when handling the hot Browning Pan. Use oven mitts when handling the hot grill rack.

Custom Grill Chart

Use the following chart as a guide when custom grilling.

FUNCTION	FOOD
Grill only	½" (13 mm) steaks, medium doneness
Grill + microwaves, 10%	½" (13 mm) steaks, medium-well, and boneless chops, shrimp
Grill + microwaves, 20%	vegetables, hot dogs, precooked sausage
Grill + microwaves, 30%	hamburger patties, raw sausage, bone-in chicken pieces and chops
Grill + microwaves, 40%	1" (25 mm) steaks, well-done

Boil & Simmer

The Boil & Simmer function has programs for simmering rice and pasta. Use the Manual Simmer function for foods such as soups, casseroles, stews and other liquid food. Boil & Simmer is a sensor function.

- Cover dish with its lid, not plastic wrap.
- Do not remove lid or covering while container is in oven. The large amount of steam released will disrupt sensor settings.

FOOD TO BE SIMMERED

White Rice: Long grain, Short grain or Instant

Brown Rice: Long grain or Instant

Fresh Pasta: Tortellini, Linguine or Ravioli

Dried Pasta: Spaghetti, Macaroni, Rotini, Penne or Fettuccine

To Use Boil & Simmer:

1. On "Home" screen, touch "More Choices."
2. Touch "Boil & Simmer."
3. Follow menu to select specific food to be simmered.
4. Enter amount.

Doneness may be adjusted at this time by touching "Doneness," and then touching "+" or "-."

Preparation instructions can be viewed for the specific food by touching "Prepare."

5. Touch "Start" or press START button.
"Boiling Water" will appear on the display for pasta, or "Cooking" will appear on the display for rice.

If simmering pasta, when water begins to boil, 2 short tones will sound, and "Add food." will appear on the display. Open door, remove container, add food to boiling water, replace container in oven, close door and touch "Continue." The display will count down the simmer time.

If simmering rice, when water begins to boil, the display will count down the simmer time.

When the cycle ends, the "End" screen will appear in the display, 4 end-of-cycle tones will sound, and then reminder tones will sound every minute.

6. Press OFF/CANCEL or open the door to clear the display and/or stop reminder tones.

To Use Manual Simmer:

1. On "Home" screen, touch "More Choices."
2. Touch "Boil & Simmer."
3. Touch "Manual Simmer."

4. Enter simmer time.

See "Manual Simmer Chart" for instructions.

5. Touch "Start" or press START button.

"Simmer Cook" will appear on the display. When water begins to boil, the display will count down the simmer time.

When the cycle ends, the "End" screen will appear in the display, 4 end-of-cycle tones will sound, and then reminder tones will sound every minute.

6. Press OFF/CANCEL or open the door to clear the display and/or stop reminder tones.

Manual Simmer Chart

Use the following chart as a guide when using the "Manual Simmer" function.

FOOD	INSTRUCTIONS
Pasta*	Add 1 tbsp (15 mL) oil to water. Place the dish containing water in microwave oven. No need to enter a simmer time. The water will heat to a boil and then the oven will turn off. Place the pasta in the water and cover the dish. Repeat steps 1-3 under "To Use Manual Simmer," then enter simmer time.
Rice and Vegetables	Place water and food in dish. Use ¼-½ cup (60-125 mL) water with vegetables. Place dish in microwave oven. Set simmer time.
Soup and liquid foods	Place food in dish and place dish in microwave oven. Set simmer time.

*Use a dish large enough to completely cover food with water.

Browning Pan Feature

The Browning Pan feature uses the pan to brown, crisp, and pan-fry foods in the oven. The Browning Pan reaches its optimal cooking temperature in approximately 3 minutes. Use the pan as quickly as possible after it is heated for best results.

While microwaves heat food from above, they also heat the pan very quickly from below to brown and crisp the food.

- Oven cavity and door will become very hot during grill element use. The use of oven mitts is recommended.
- The Browning Pan will become very hot. Use the handle to grasp and remove the pan from the oven. Do not place hot Browning Pan directly on heat-sensitive surfaces. Damage may occur.
- Do not use plastic utensils on the pan, as it becomes very hot quickly and could melt the utensils.
- Do not use metal utensils, as they can scratch the pan.
- Do not use the pan in any other microwave oven or in a thermal oven.
- Do not place the pan on the rectangular cooking rack or circular grill rack. Always use the turntable as a support for the pan.
- For best results, coat pan lightly with cooking oil to make removing food and cleaning easier.

Browning Pan Cooking Chart

Use the following chart as a guide when using the browning function.

FOOD

Bacon*: 2-4 slices

Omelet: 2-4 eggs

Fried Eggs*: 1-4 eggs

Hamburger Patties*: 1-4 patties

Fish* (Frozen, Breaded): 1-4 servings

Nuts*: .5, 1, 1.5 or 2 cups (125, 250, 375 or 500 mL)

Pizza (Rising or Thin crust): 6-12" (15-30 cm) pizza

Poultry*, Breast: 1-3 pieces, .4 lb (180 g) each

*Requires turning or stirring of food.

To Use:

1. Place empty Browning Pan on turntable.
2. On "Home" screen, touch "More Choices."
3. On "More Choices" screen, touch "Browning Pan."
4. Select food or touch "Manual" for foods not on the menu.
5. Press number buttons to enter amount.
Doneness may be adjusted at this time by touching "Doneness," and then touching "+" or "-."

Preparation instructions can be viewed for the specific food by touching "Prepare."

6. Touch "Start" or press START button.
"Preheating Pan" will appear on the display. When Browning Pan is preheated, 2 short tones will sound, and "Place food in pan." will appear on the display. Open door, place food in Browning Pan, close door and touch "Continue."

The display will count down the cooking time.

If required, when food is ready to be turned or stirred, two short tones will sound, and "Turn over food." or "Stir food." will appear on the display. Open the door, turn or stir food, close door and touch "Continue."

When the cycle ends, the "End" screen will appear in the display, 4 end-of-cycle tones will sound, and then reminder tones will sound every minute.

7. Press OFF/CANCEL or open the door to clear the display and/or stop reminder tones.

To Use Manual Browning:

1. On "Home" screen, touch "More Choices."
2. Touch "Browning Pan."
3. Touch "More Choices."
4. Touch "Manual."
5. Enter a browning time.
6. Press START.

When the cycle ends, the "End" screen will appear in the display, 4 end-of-cycle tones will sound, and then reminder tones will sound every minute.

7. Press OFF/CANCEL or open the door to clear the display and/or stop reminder tones.

Manual browning may be used as the first stage in stage cooking. See "Cooking in Stages" section.

Soften and Melt

The oven uses low power to soften and melt certain foods. Soften butter and cream cheese so they will be ready to use in a recipe. Ice cream will be softened enough to make scooping easier. Melt items such as butter, chocolate and marshmallows with minimal spatter. Use the following chart as a guide.

FOOD TO BE SOFTENED	FOOD TO BE MELTED
Butter: 1, 2 or 3 sticks	Butter: 1, 2 or 3 sticks
Cream cheese: 3 or 8 oz (85 or 250 mL)	Cheese: 8 or 16 oz (227 or 454 g)
Frozen Juice: 6, 12 or 16 oz (173, 355 or 500 mL)	Chocolate: 4, 6, 8 or 12 oz (113, 170, 227 or 340 g)
Ice cream: 16, 32 or 64 oz (500 mL, 1 L or 2 L)	Marshmallows: 5 or 10 oz (142 or 283 g)

To Soften or Melt:

1. Place container of food on turntable.
2. On "Home" screen, touch "Melt"
or
touch "More Choices" and then "Soften."
3. Select food item to be softened or melted.
4. Enter amount.
Doneness may be adjusted at this time by touching "Doneness," and then touching "+" or "-."
Preparation instructions can be viewed for the specific food by touching "Prepare."
5. Touch "Start" or press START button.
The display will count down the Soften or Melt time.
When the cycle ends, the "End" screen will appear in the display, 4 end-of-cycle tones will sound, and then reminder tones will sound every minute.
When melting, foods may not be completely melted when the program ends, but stirring the food will complete the melting.
6. Press OFF/CANCEL or open the door to clear the display and/or stop reminder tones.

Keep Warm

WARNING

Food Poisoning Hazard

Do not let food sit in oven more than one hour before or after cooking.

Doing so can result in food poisoning or sickness.

Hot cooked food can be kept warm in the oven. Keep Warm can be used by itself or can be programmed to follow a cooking cycle.

To Use:

Put hot cooked food in the oven. Cover plates of food and foods that were cooked covered. Pastries, pies, turnovers, etc. should remain uncovered.

1. On "Home" screen, touch "More Choices."
2. Touch "Hints & Settings."
3. Touch "Keep Warm."
4. Adjust time, if desired, and then touch "Start."
The display will show "Keep Warm."

When the cycle ends, the "End" screen will appear in the display, 4 end-of-cycle tones will sound, and then reminder tones will sound every minute.

5. Press OFF/CANCEL or open the door to clear the display and/or stop reminder tones.

To Set at end of cycle: Follow instructions in "Cooking in Stages," and set the last stage as the Keep Warm stage.

OVEN CARE

General Cleaning

IMPORTANT: Before cleaning, make sure all controls are off and the oven is cool. Always follow label instructions on cleaning products.

Soap, water and a soft cloth or sponge are suggested first unless otherwise noted.

GREASE FILTERS

Do not operate the microwave oven without the grease filters in place.

Soak grease filters in hot water and mild detergent. Scrub and swish to remove embedded dirt. Rinse well and shake dry.

- Do not use ammonia or oven cleaner.
- Do not place in dishwasher.

OVEN CAVITY

The gray finish inside the oven cavity is a durable, nonstick coating that makes soils easier to remove.

Do not use soap-filled scouring pads, abrasive cleaners, steel-wool pads, gritty washcloths or paper towels made from recycled material. Damage may occur.

The area where the oven door and frame touch when closed should be kept clean.

Average soil

- Mild, nonabrasive soaps and detergents:
Rinse with clean water and dry with soft, lint-free cloth.

Heavy soil

- Mild, nonabrasive soaps and detergents:
Heat 1 cup (250 mL) of water for 2 to 5 minutes in oven. Steam will soften soil. Rinse with clean water and dry with soft, lint-free cloth.

Odors

- Lemon juice or vinegar:
Heat 1 cup (250 mL) of water with 1 tbsp. (15 mL) of either lemon juice or vinegar for 2 to 5 minutes in oven.

CONTROL PANEL

Do not use abrasive cleaners, steel-wool pads or gritty washcloths. Damage may occur.

Unplug oven or disconnect power to avoid touch screen activation.

Use gentle pressure when wiping the touch screen.

- Glass cleaner and soft cloth:
Apply glass cleaner to soft cloth, not directly on panel.
- Mild cleanser, water and soft washcloth

OVEN DOOR EXTERIOR

- Glass cleaner and paper towels or nonabrasive plastic scrubbing pad:

Apply glass cleaner to soft cloth or sponge, not directly on panel.

TURNTABLE

Replace turntable immediately after cleaning. Do not operate the microwave oven without the turntable in place.

- Mild cleanser and scouring pad
- Dishwasher

BROWNING PAN

Do not use abrasive cleansers or scrubbers.

- Mild cleanser, water and washcloth
- Dishwasher

COOKING and GRILL RACKS

Dishwasher cleaning is not recommended. Do not use abrasive cleansers or scrubbers.

- Mild soap, water and washcloth

Replacing Filters

The grease filters should be removed and cleaned at least once a month. Do not operate the oven without the filters in place. The charcoal filter cannot be washed and should be replaced every 6 to 12 months. See "Assistance or Service" to reorder filters. See "General Cleaning" for cleaning instructions.

To Remove:

1. Unplug oven or disconnect power.
2. Remove each of the grease filters by pushing the back of the filter up, grasping the tab, and sliding the filter to the back. Pull tab down until the filter drops out.

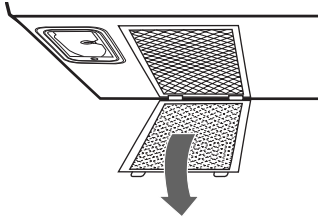

3. Remove each charcoal filter by pushing the filter toward the center of the oven until it is clear of the narrow outer lip. Swing the filter down and slide it out.

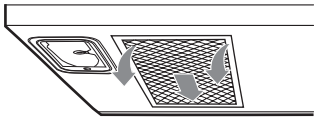

To Replace:

1. Replace each charcoal filter by positioning it above the wide lip near the center of the oven. Swing the filter up into position and slide it toward the narrow lip. The filter will now be held in position between the lips.
2. Replace each grease filter by inserting the end without the tab into the frame. Swing other side up and slide into position.
3. Plug in oven or reconnect power.

Replacing Cooktop Light

The cooktop light is a 10W low-voltage halogen capsule bulb. See "Assistance or Service" section to reorder.

To Replace:

1. Unplug oven or disconnect power.
2. Remove bulb cover mounting screw, and carefully remove cover.

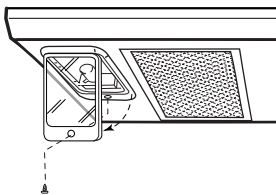

3. Remove the burned-out bulb.
4. Replace bulb, using a tissue to handle the bulb, or wearing cotton gloves. Do not touch bulb with bare fingers.
5. Replace bulb cover and mounting screw.
6. Plug in oven or reconnect power.

Replacing Oven Light

The oven light is a 10W low-voltage halogen capsule bulb. It will automatically come on when the door is opened and when the oven is operating. See "Assistance or Service" section to reorder.

To Replace:

1. Unplug oven or disconnect power.
2. Pull the vent grille out.

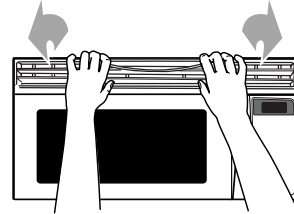

3. Lift up the bulb cover.

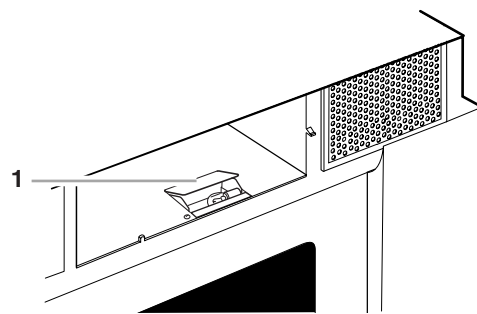

1. Bulb cover

4. Replace light. Close bulb cover.
5. Slide the bottom of the vent grille into place. Push the top until it snaps into place.

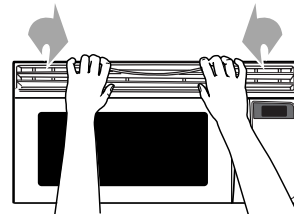

6. Plug in oven or reconnect power.

TROUBLESHOOTING

Try the solutions suggested here first in order to avoid the cost of an unnecessary service call.

Nothing will operate

- **Has a household fuse blown or has the circuit breaker tripped?**
Replace the fuse or reset the circuit.
- **Is the appliance wired properly?**
See Installation Instructions provided with your oven.

Oven will not operate

- **Is the door completely closed?**
Firmly close door.
- **The a spacer (on some models) attached to the inside of the door?**
Remove spacer, then firmly close door.
- **Is the electronic oven control set correctly?**
See "Oven Control" section.
- **Is the Child Lock set?**
See "Child Lock" section.
- **Is the Learning Mode activated?**
See "Learning Mode" section.
- **Is the magnetron working properly?**
Try to heat 1 cup (250 mL) of cold water for 2 minutes at 100% cooking power. If water does not heat, call for service. See "Assistance or Service" section.

Touch screen does not take command, or takes wrong command

- Try using fingertip or fingernail. See "Display/Touch Screen" section.

Oven door looks wavy

- This is normal and will not affect performance.

Turntable will not operate

- **Is the turntable properly in place?**
Make sure turntable is correct-side up and is sitting securely on the turntable support.
- **Is the turntable support operating properly?**
Remove turntable. Remove and replace turntable support. Replace turntable. Put in 1 cup (250 mL) of water, then restart oven. If still not working, call for service. See "Assistance or Service" section. Do not operate the oven without turntable and turntable support working properly.

Turntable rotates both directions

- This is normal and depends on motor rotation at beginning of cycle.

Display shows messages

- **Is the display showing "Home"?**
There has been a power failure or the clock time has been turned off. See "Clock" section to reset the clock or to turn it on.
- **Is the display showing a letter followed by a number?**
Press the cancel pad/button to clear the message. If it reappears, call for service. See "Assistance or Service" section.

Display shows time countdown, but is not operating

- **Is the Timer in use?**
See "Timer" section.
- **Is the Learning Mode in use?**
See "Learning Mode" section.

Tones are not sounding

- **Are tones turned off?**
See "Tones" section.

Steam is coming from the vent grille

- Some steam is normal.

Fan running slower than usual

- **Has the oven been stored in a cold area?**
The fan will run slower until the oven warms up to normal room temperature.

Cooking times seem too long

- **Is the cooking power set properly?**
See "Cooking Power" section.
- **Are large amounts of food being heated?**
Larger amounts of food need longer cooking times.
- **Is the incoming voltage less than specified in "Microwave Oven Safety?"**
Have a qualified electrician check the electrical system in the home.

Radio or TV Interference

- **Is the oven plugged into the same outlet?**
Try a different outlet.
- **Is the radio or TV receiver near the microwave oven?**
Move the receiver away from the oven, or adjust the radio or TV antenna.
- **Are the oven door and sealing surfaces clean?**
Make sure these areas are clean.

ASSISTANCE OR SERVICE

Before calling for assistance or service, please check “Troubleshooting.” It may save you the cost of a service call. If you still need help, follow the instructions below.

When calling, please know the purchase date and the complete model and serial number of your appliance. This information will help us to better respond to your request.

If you need replacement parts

If you need to order replacement parts, we recommend that you only use factory specified parts. These factory specified parts will fit right and work right because they are made with the same precision used to build every new KITCHENAID® appliance.

To locate factory specified parts in your area, call our Customer Interaction Center telephone number or your nearest KitchenAid designated service center.

In the U.S.A.

Call the KitchenAid Customer Interaction Center toll free:
1-800-422-1230.

Our consultants provide assistance with:

- Features and specifications on our full line of appliances.
- Installation information.
- Accessory and repair parts sales.
- Specialized customer assistance (Spanish speaking, hearing impaired, limited vision, etc.).
- Referrals to local dealers, repair parts distributors, and service companies. KitchenAid designated service technicians are trained to fulfill the product warranty and provide after-warranty service, anywhere in the United States.

To locate the KitchenAid designated service company in your area, you can also look in your telephone directory Yellow Pages.

For further assistance

If you need further assistance, you can write to KitchenAid with any questions or concerns at:

KitchenAid Brand Home Appliances
Customer Interaction Center
553 Benson Road
Benton Harbor, MI 49022-2692

Please include a daytime phone number in your correspondence.

Replacement Parts

Glass Turntable
Part No. 4393799

Turntable Support and Rollers
Part No. 8184102

Turntable Rollers
Part No. 4393861

Turntable Hub
Part No. 8183949

Cooking Rack (rectangular)
Part No. 8184865

Cooktop and Oven Halogen
Capsule Bulb
Part No. 8204670

Browning Pan
Part No. 8184863

Handle (for Browning Pan)
Part No. 8204652

Grill Rack (circular)
Part No. 8184862

Grease Filters
Part No. 8184001

Charcoal Filters
Part No. 8184002

Steamer Vessel (accessory)
Part No. 8184864

KITCHENAID® MICROWAVE HOOD COMBINATION WARRANTY

ONE-YEAR FULL WARRANTY

For one year from the date of purchase, when this appliance is operated and maintained according to instructions attached to or furnished with the product, KitchenAid will pay for factory specified parts and repair labor costs to correct defects in materials or workmanship. Service must be provided by a KitchenAid designated service company.

SECOND THROUGH FIFTH YEAR LIMITED WARRANTY ON MAGNETRON TUBE, ELECTRIC OVEN ELEMENTS, AND SOLID STATE TOUCH CONTROL SYSTEM

In the second through fifth years from the date of purchase, when this appliance is operated and maintained according to instructions attached to or furnished with the product, KitchenAid will pay for factory specified parts for the microwave magnetron tube, any electric oven element and the solid state touch control system to correct defects in materials or workmanship.

SECOND THROUGH TENTH YEAR LIMITED WARRANTY ON STAINLESS STEEL OVEN CAVITY/INNER DOOR

In the second through tenth years from date of purchase, when this appliance is operated and maintained according to instructions attached to or furnished with the product, KitchenAid will pay for factory specified parts for the stainless steel oven cavity/inner door if the part rusts through due to defects in materials or workmanship.

KitchenAid will not pay for:

1. Service calls to correct the installation of your appliance, to instruct you how to use your appliance, to replace house fuses or correct house wiring, or to replace owner-accessible light bulbs.
 2. Repairs when your appliance is used in other than normal, single-family household use.
 3. Pickup and delivery. Your appliance is designed to be repaired in the home.
 4. Damage resulting from accident, alteration, misuse, abuse, fire, flood, improper installation, acts of God or use of products not approved by KitchenAid.
 5. Repairs to parts or systems resulting from unauthorized modifications made to the appliance.
 6. Replacement parts or repair labor costs for units operated outside the United States.
 7. Any labor costs during the limited warranty periods.
-

KITCHENAID SHALL NOT BE LIABLE FOR INCIDENTAL OR CONSEQUENTIAL DAMAGES.

Some states do not allow the exclusion or limitation of incidental or consequential damages, so this exclusion or limitation may not apply to you. This warranty gives you specific legal rights, and you may also have other rights which vary from state to state.

Outside the 50 United States, this warranty does not apply. Contact your authorized KitchenAid dealer to determine if another warranty applies.

If you need service, first see the "Troubleshooting" section of this book. After checking "Troubleshooting," additional help can be found by checking the "Assistance or Service" section or by calling the KitchenAid Customer Interaction Center, **1-800-422-1230** (toll-free), from anywhere in the U.S.A. 5/00

Keep this book and your sales slip together for future reference. You must provide proof of purchase or installation date for in-warranty service.

Write down the following information about your appliance to better help you obtain assistance or service if you ever need it. You will need to know your complete model number and serial number. You can find this information on the model and serial number label/plate, located on your appliance as shown in the "Parts and Features" section.

Dealer name _____
Address _____
Phone number _____
Model number _____
Serial number _____
Purchase date _____