

Contents

	Page		Page
Parts and Features	2	Changing or Adding Instructions	16
Before You Install		Cancelling Instructions	16
Your Microwave Oven	3	Programming Tone	16
Before You Use Your		Other Operating Hints	17
Microwave Oven	3	Bi-Level Cooking	17
Precautions to Avoid Possible		Operating Safety Precautions	17
Exposure to Excessive		Installation Instructions	19
Microwave Energy	3	Grounding Instructions	20
Important Safety Instructions	4	Building in Your Microwave Oven	21
Using Your Microwave Oven	5	Caring for Your Microwave Oven	21
Microwave Oven Controls	5	Cleaning the Microwave Oven	21
Setting the Clock	6	Replacing the Light Bulb	21
Cooking at High Cook Power	6	How Your Microwave Oven Works	22
Cooking at Lower Cook Powers	7	If You Need Service or Assistance	23
Defrosting	9	1. Before Calling for Assistance	23
Cooking Automatically after		2. If You Need Assistance	23
Defrosting	10	3. If You Need Service	23
Cooking with the Temperature Probe	12	4. If You Have a Problem	23
Minute Timer	15		

©1984 Whirlpool Corporation

Parts and features

Model MW8520XP

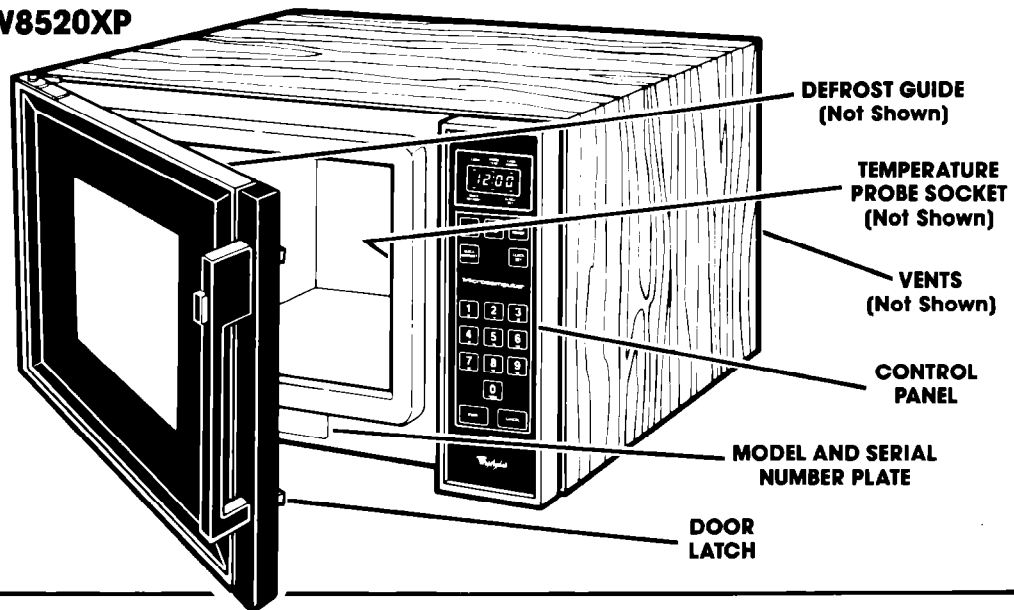

Copy your Model and Serial Numbers here...

If you need service or call with a question, have this information ready:

1. **Complete** Model and Serial Numbers (from the plate just behind the microwave oven door on the oven frame).
2. Purchase date from sales slip.

Copy this information in these spaces. Keep this book, your warranty and sales slip together in a handy place. There is no warranty registration to return. Proof-of-purchase is all that is required for in-warranty service.

Model Number _____

Serial Number _____

Purchase Date _____

Service Company Phone Number _____

Fill out and return the "Microwave Registration Card" attached to the oven door. If the card is missing, please send the model number of your microwave oven, with your name and address to...

Whirlpool Corporation
Microwave Registration Department
Administrative Center
2000 U.S. 33 North
Benton Harbor, Michigan 49022

This information will help us reach you if there is ever a need to pass along information about your microwave oven.

Before you install your microwave oven

Read and carefully follow the "INSTALLATION INSTRUCTIONS" found on page 19 of this "Use & Care Guide."

Before you use your microwave oven

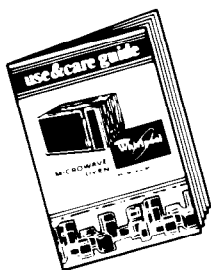

Read this "Use & Care Guide" carefully for important use and safety information. Store in a convenient place for future use.

It is your personal responsibility and obligation to be sure your microwave oven:

- Has been installed where it is protected from the elements. **The microwave oven should be at a temperature above 50°F (10°C) for proper operation.**
- Has been installed on a surface strong enough to support its weight.
- Has been properly connected to electrical supply and grounded.
(See "Installation Instructions.")
- Is not used by children or anyone unable to operate it properly.
- Is properly maintained.
- Is used only for jobs expected of a home microwave oven.

PRECAUTIONS TO AVOID POSSIBLE EXPOSURE TO EXCESSIVE MICROWAVE ENERGY...

DO NOT attempt to operate this oven with the door open since open-door operation can result in harmful exposure to microwave energy. It is important not to defeat or tamper with the safety interlocks.

DO NOT place any object between the oven front face and the door or allow soil or cleaner residue to accumulate on sealing surfaces.

DO NOT operate the oven if it is damaged. It is particularly important that the oven door close properly and that there is no damage to the

- (1) Door (bent),
- (2) Hinges and latches (broken or loosened),
- (3) Door seals and sealing surfaces.

DO NOT operate the microwave oven if the door glass is broken.

The microwave oven should be checked for microwave leakage by qualified service personnel after a repair is made.

The oven should not be adjusted or repaired by anyone except properly qualified service personnel.

DO NOT operate the microwave oven with the outer cabinet removed.

IMPORTANT SAFETY INSTRUCTIONS

Microwave ovens have been used successfully in homes for a number of years. They are thoroughly tested for safe and efficient operation. However, as with any appliance, there are special installation and safety precautions which must be followed to ensure safe and satisfactory operation and prevent damage to the unit.



WARNING – To reduce the risk of burns, electric shock, fire, injury to persons or exposure to excessive microwave energy:

1. Read all instructions before using appliance.
2. Read and follow the specific "PRECAUTIONS TO AVOID POSSIBLE EXPOSURE TO EXCESSIVE MICROWAVE ENERGY" found on page 3.
3. This appliance must be grounded. Connect only to properly grounded outlet. See "GROUNDING INSTRUCTIONS" found on page 20.
4. Install or locate this appliance only in accordance with the provided "INSTALLATION INSTRUCTIONS" found on page 19.
5. Some products such as whole eggs and sealed containers – for example, closed glass jars – may explode and should not be heated in this oven.
6. Use this appliance only for its intended use as described in this manual.
7. As with any appliance, close supervision is necessary when used by children.
8. Do not operate this appliance if it has a damaged cord or plug, if it is not working properly, or if it has been damaged or dropped. Electric shock, fire or other hazards may result.
9. This appliance should be serviced only by qualified service personnel. Call a Whirlpool authorized TECH-CARE® Service Company for examination, repair or adjustment.
10. Do not cover or block any opening on the appliance, for fire may result.
11. Do not use outdoors for damage to the oven or electric shock may result.
12. Do not immerse cord or plug in water for electric shock may result.
13. Keep cord away from heated surfaces for electric shock may result.
14. Do not let cord hang over edge of table or counter for electric shock may result.
15. See door surface cleaning instructions on page 21.
16. To reduce the risk of fire in the oven cavity:
 - a. Do not overcook food. Carefully attend appliance if paper, plastic, or other combustible materials are placed inside the oven to facilitate cooking. Paper can char or burn, and some plastics can melt if used when heating foods.
 - b. Remove wire twist-ties from paper or plastic bags before placing bag in oven. Cooking in metal containers can damage the oven. So can containers with hidden metal (twist-ties, foil-lining, staples, metallic glaze or trim). Test dinnerware or cookware before using. See page 17.
 - c. If materials inside the oven should ignite, keep oven door closed, turn oven off, and disconnect the power cord, or shut off power at the fuse or circuit breaker panel.
17. Read and follow "OPERATING SAFETY PRECAUTIONS" starting on page 17.

SAVE THESE INSTRUCTIONS

Using your microwave oven

Microwave oven controls

There are three parts in the control section:

- The Digital Display/Clock, and Signal Lights
- Command Pads
- Number Pads

Instructions for each control are covered on the following pages. Read them carefully.



When you first plug in the oven, the Display will show 88:88. If, after you set the Clock (page 6), the Display again shows all 8's, it means your electricity was off for a while. Reset the Clock.

Digital display/clock and signal lights



When you are not using the microwave oven, this is an accurate digital clock. When you are using the microwave oven, this displays time, temperature and Cook Power settings, signal lights and shows you what Number Pads you touched.

Command pads

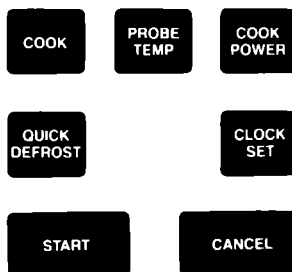

Touch Command Pads to tell the microwave oven what to do and in what order. A few examples:

- CLOCK SET tells the oven you are going to set the clock.
- START tells the oven to start. See

page 16 for information on the tone you hear when touching any pad.

Each Command Pad (except START and CANCEL) lights a Signal Light. The Signal Light comes on when you touch the Command Pad.

While the oven is running, a Signal Light (or lights) will be on to show what the oven is doing.

Number pads

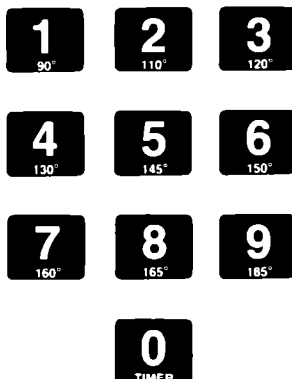

Once you've touched a Command Pad to tell the oven what you want it to do, you'll touch Number Pads to tell it...

- a time,
- a Cook Power,
- a food temperature.

Setting the clock

When the oven is first plugged in, the Display shows **88:88**. If the electric power ever goes off, the Display will also show all 8's when the power comes back on.

You can cook without setting the clock, but the display will be blank after cooking.

The oven door must be closed before setting the clock.

DO THIS...



1. Touch **CLOCK SET**.

THIS HAPPENS...

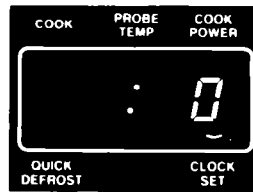

The **CLOCK SET** Signal Light will come on. The Display will show a "0". **Start touching number pads for the desired time within 5 seconds.**



2. Touch Number Pads for the correct time of day.

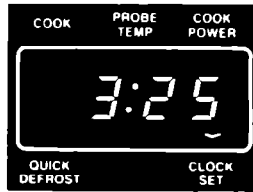

The Display will show what numbers you touched **in the order you touched them**. This example shows 3:25.



3. Touch **START**.

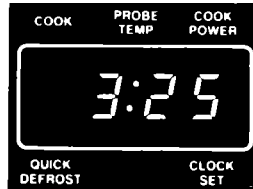

The Clock is set when the **CLOCK SET** Signal Light goes off.

The Display will flash on and off if you have touched in an incorrect time such as 12:65.

Cooking at high cook power

DO THIS...

1. Put food in the oven and close the door.



2. Touch **COOK**.

THIS HAPPENS...



The **COOK** Signal Light will come on and the Display will show four 0's.



3. Touch Number Pads for the cooking time you want.



The Display will show the numbers you touched **in the order you touched them**. This example shows 1 minute, 30 seconds.



4. Touch START.

The oven will automatically cook at high Cook Power.



The COOK Signal Light will stay on to show that the oven is cooking.

The Display counts down the time to show how much cooking time is left in the Cook cycle.

count
down

BEEP
BEEP
BEEP
BEEP

When the cooking time ends you will hear 4 beeps. (You can stop the beeping by opening the oven door or touching CANCEL.) When the beeping stops, the Display will show the time of day.

Changing the cooking time

You can change the cooking time anytime during the cycle:

1. Touch COOK.
2. Touch numbers for new time.
3. Touch START.

The COOK cycle will continue cooking for the new time.

Cooking at lower powers

For best results, some recipes call for lower Cook Powers. The lower the Cook Power, the slower the cooking. Each Number Pad on your microwave oven stands for a different percentage of Cook Power. Many recipes in your MICRO MENUS* Cookbook tell you, by number, which Cook Power to use. Recipes in other books and magazines may tell you by name (HI, MED, LO, etc.) or percentage (10%, 50%, 80%, etc.).

The following chart gives you the percentage of Cook Power each Number Pad stands for, and Cook Power name usually used. *Tmk.

automatic 100% of full power HIGH	
9 = 90% of full power	4 = 40% of full power
8 = 80% of full power	3 = 30% of full power MED-LOW
7 = 70% of full power MED-HIGH	2 = 20% of full power
6 = 60% of full power	1 = 10% of full power LOW
5 = 50% of full power MED	0 = no power (fan and light will be off)

DO THIS...

THIS HAPPENS...

1. Put food in the oven and close the door.



2. Touch COOK.



The COOK Signal Light will come on and the Display will show four 0's.



3. Touch Number Pads for the cooking time you want.

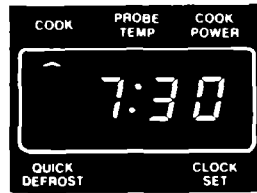

The Display will show the numbers you touched **in the order you touched them**. This example shows 7 minutes, 30 seconds.



4. Touch COOK POWER.

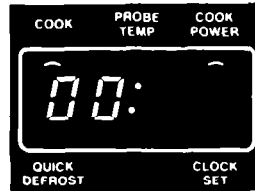

The COOK POWER Signal Light will come on and the Display will show two 0's.



5. Touch a Number Pad for the Cook Power you want.

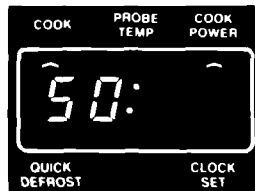

The display will show what you touched. This example shows 50% of full power.



6. Touch START.



The COOK and COOK POWER Signal Lights will stay on to show that the oven is cooking at a Cook Power other than high.

count down

The Display counts down the time to show how much cooking time is left.

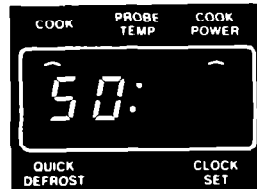

For 2 of every 10 seconds, the Display will show the Cook Power you selected.

BEEP
BEEP
BEEP
BEEP

When the cooking time ends, you will hear 4 beeps. (You can stop the beeping by opening the door or by touching CANCEL.) When the beeping stops, the Display will show the time of day.

Changing cook powers

- **Cook Power** can be changed at any time during the cooking cycle.
 - Touch COOK POWER.
 - Touch a number for the new Cook Power.
 - Touch START. The oven will cook at the new Cook Power for the original time.
- OR...**
 - Touch COOK POWER **twice**, then touch START, if you want to change a lower Cook Power to high.

Defrosting

Use Quick Defrost to thaw frozen food before cooking. For suggested defrost times, see the guide on the inside of the oven door or the chart in your MICRO MENUS* Cookbook.

*Tmk.

DO THIS...

THIS HAPPENS...

1. Put frozen food in the oven and close the door.



2. Touch QUICK DEFROST.



The QUICK DEFROST Signal Light will come on and the Display will show four 0's.



3. Touch Number Pads for the defrosting time you want.

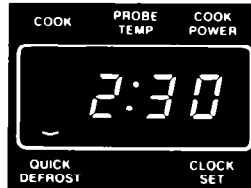

The Display will show the numbers you touched **in the order you touched them**.

This example shows 2 minutes, 30 seconds.



4. Touch START.



The QUICK DEFROST Signal Light will stay on to show that the oven is in the QUICK DEFROST Cycle.

The Display counts down the time to show how much defrosting time is left.

count
down

BEEP
BEEP
BEEP
BEEP

When the defrost time ends, you will hear 4 beeps. (You can stop the beeping by opening the oven door or touching CANCEL.) When the beeping stops, the Display will show the time of day.

Standing time

For best results, allow the food to stand for a while after defrosting. This helps equalize the temperature of the food to provide more even defrosting.

When the COOK Cycle follows QUICK DEFROST, the oven automatically provides a standing time equal to the time touched in for QUICK DEFROST. The COOK Cycle will begin after the automatic standing time.

About the "QUICK DEFROST" Cycle

The microwave oven automatically divides the time set for the QUICK DEFROST Cycle into three equal parts:

- First part 80% of full Cook Power;
- Second part 50% of full Cook Power;
- Third part 20% of full Cook Power.

This automatic step-down in Cook Power helps defrost food quickly and completely with less cooking.

Changing or adding defrost time

You can change the defrosting time while the QUICK DEFROST Cycle is operating:

1. Touch QUICK DEFROST.
2. Touch numbers for the new time.
3. Touch START.

Any new time setting made while QUICK DEFROST is operating will continue the defrosting only at 20% of full Cook Power.

The best time to change the setting is near the end of the QUICK DEFROST Cycle.

1. Open the door.
2. Check the food with long-tined fork; if center area is hard frozen, set additional time. Remember that standing time will further defrost the food.
3. Close the door and touch START to continue the cycle if no additional time is needed.
4. **Or**, touch in new instructions if additional time is needed.

Cooking automatically after defrosting

The controls can be set so the microwave oven goes automatically from defrosting to the Cook Cycle you have touched in.

DO THIS...

THIS HAPPENS...

1. Put frozen food in the oven and close the door.



2. Touch QUICK DEFROST.



The QUICK DEFROST Signal Light will come on and the Display will show four 0's.



3. Touch Number Pads for defrosting time you want.



The Display will show the numbers you touched **in the order you touched them**. This example shows 2 minutes, 30 seconds.



4. Touch COOK.



The COOK Signal Light will come on and the Display will show four 0's.



5. Touch Number Pads for the cooking time you want.



The Display will show the numbers you touched **in the order you touched them**. This example shows 3 minutes, 25 seconds.



6. Touch **COOK POWER**.
(Options: Skip to 8 if you want to cook at high power.)

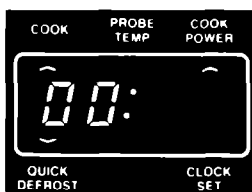

The **COOK POWER** Signal Light will come on and the Display will show two 0's.



7. Touch a Number Pad for the Cook Power you want.



The Display will show what you touched. This example shows 60% of full power.



8. Touch **START**.



When you touch **START**, the **QUICK DEFROST** Signal Light will stay on. All other Signal Lights will go off.

The Display counts down the time to show how much time is left in the defrost cycle.

When the defrost time ends, the microwave oven automatically lets the food stand for the **same amount of time used for defrosting**. The **QUICK DEFROST** Signal Light stays on and the Display counts down the standing time. **During the count-down the oven will be dark, and the fan will be off.**

When the standing time is over, you will hear 2 beeps and the cooking cycle will start.

The **COOK** Signal Light will be on during the cooking cycle. The **COOK POWER** Light will also be on if **you are using a Cook Power other than high.**

The Display counts down the time to show how much time is left in the cooking cycle.

For 2 of every 10 seconds, the Display will show the Cook Power you selected if you are using a Cook Power other than high.

When the Cook Cycle ends, you will hear 4 beeps. (You can stop the beeping by opening the oven door or touching **CANCEL**.) When the beeping stops, the Display will show the time of day.

count down



BEEP BEEP



count down



BEEP BEEP BEEP BEEP

Cooking with the TEMPERATURE PROBE

The Temperature Probe helps take guesswork out of cooking roasts and larger casseroles. The probe is designed to turn the oven off when it senses the temperature you choose. See your MICRO MENUS* Cookbook for helpful information in cooking different types of food.

Temperature settings are printed on the Number Pads

*Tmk.

DO THIS...

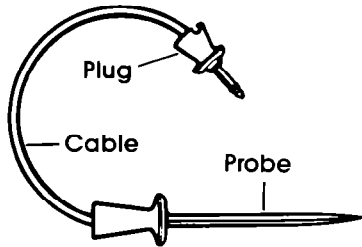

1. Insert at least 1/3 of the temperature probe into the food.

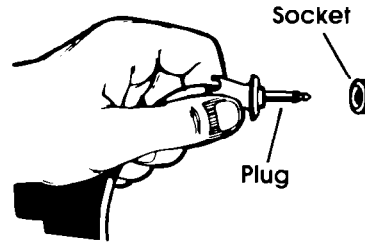

2. Place food in the oven and plug the probe into the socket on the oven wall.

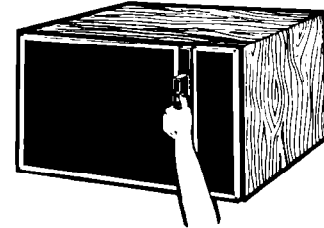

3. Make sure the probe does not touch any part of the oven interior. Close the door.

DO THIS...



4. Touch PROBE TEMP.

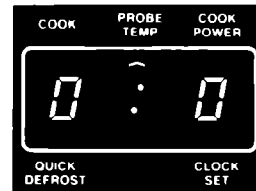

The PROBE TEMP Signal Light will come on and the Display will show two 0's.



5. Touch a Number Pad for the desired final temperature.

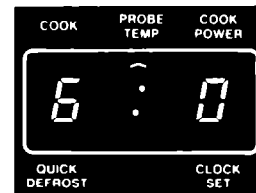

The Display will show the number you touched. This example uses 6, or a final cooked temperature of about 150°F (66°C). The 0 means the food is still cold.



6. Touch COOK POWER. (Option: Touch START if you want to use high power.)



The COOK POWER Signal Light will come on and the Display will show two 0's.



7. Touch the Number Pad for the Cook Power you want.

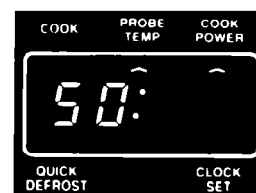

The Display will show what you touched. This example shows 50% of full power.

START

8. Touch START.

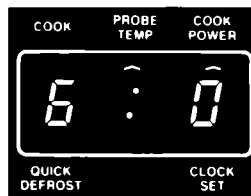

The PROBE TEMP and COOK POWER Lights will stay on.

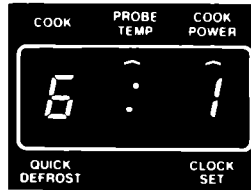

The left number on the display shows what temperature (number) you selected. The number on the right shows you how the temperature is rising in the food.



For 2 of every 10 seconds, the Display will show the Cook Power you selected if you are using a Cook Power other than high.

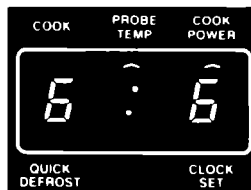

When the probe senses the temperature you selected, the oven shuts off and you will hear 4 beeps. (You can stop the beeping by opening the oven door or touching CANCEL.) When the beeping stops, the Display will show the time of day.

BEEP
BEEP
BEEP
BEEP

Hints for using the temperature probe

DO...

- use hot pads when removing probe from food or food from oven.
- stir foods during cooking when recommended.
- stir soups, casseroles and drinks before serving.
- cover roasts with foil and let stand a few minutes after cooking. Remove foil if you decide to cook it longer.

DON'T...

- let probe or probe cable touch any part of the oven interior.
- let probe touch foil (if used). Foil can be kept away from probe with wooden toothpicks. Remove foil if arcing occurs.
- use paper, plastic wrap or plastic containers. They will be in the oven too long.
- use probe in regular oven.
- force probe into frozen food.
- use probe for foods that need to simmer.

Changing the temperature setting

- When using the Temperature Probe, PROBE TEMP settings can be changed before or during operation:
 - Touch PROBE TEMP.
 - Touch number for new temperature.
 - Touch START. The oven will continue cooking to the new temperature. If the new temperature is lower than the temperature of the food, the oven will shut off.

Temperature probe cooking tips

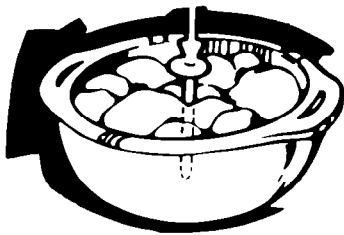

For casseroles, the tip of the probe should be in the center of the food. Stir foods when recommended. Replace the probe.

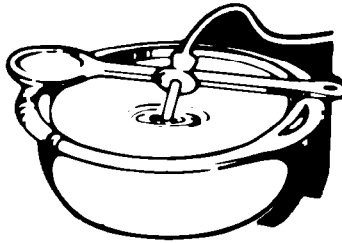

For liquids, balance the probe on a wooden spoon or spatula so the tip of the probe is in the center of the liquid.

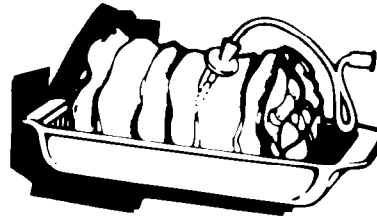

For roasts, the tip of the probe should be in the center of the largest muscle, but not touching fat or bone.

- Casseroles cooked using the Temperature Probe should be made from precooked foods. Do not use raw meats, raw vegetables and cream sauces in casseroles.
- Dry casseroles do not work well.
- Thaw frozen casseroles and meats in the microwave oven before inserting the probe.
- If you are cooking individual servings such as mugs of soup, check the probe setting in several of the items – all the mugs may not heat at the same rate.
- Dry meat loaf mixtures don't work well.
- Remember that roasts may vary in size, shape and composition. Use the timings for minutes per pound as a guideline as well as the Temperature Probe.
- Starchy vegetables tend to stick to the Temperature Probe.

Cleaning the probe

1. Remove probe from microwave oven using hot pads.
2. Wipe probe with a hot sudsy cloth. Use a plastic scouring pad to remove stubborn foods.
3. Probe may be placed in the silverware basket of the dishwasher.

Minute Timer

The microwave oven control can be used as a kitchen timer. Use COOK at "0" Cook Power for timing up to 99 minutes, 99 seconds.

DO THIS...



1. Touch COOK.



2. Touch number pads for minutes and seconds.



3. Touch COOK POWER.



4. Touch "0" number pad.



5. Touch START.

THIS HAPPENS...



The COOK Signal Light will come on and the Display will show four 0's.



The Display will show the numbers you touched **in the order you touched them**. This example shows 1 minute, 45 seconds.

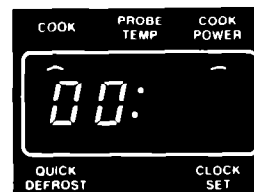

THE COOK POWER Signal Light will come on and the Display will show two 0's.

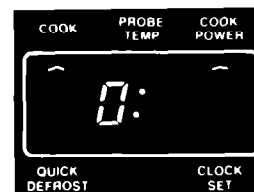

The Display will show the COOK POWER you touched...0% for minute timer operation.



The COOK and COOK POWER Signal Lights will stay on to show that the timer is running.

The Display counts down to show how much time is left. During the countdown the oven will be dark and the fan will be off.

For 2 of every 10 seconds, the Display will show 0% Cook Power.

When the set time ends, you will hear 4 beeps. (You can stop the beeping by opening the oven door or touching CANCEL.) When the beeping stops, the Display will show the time of day.

Opening the oven door stops the count down. Close the door and touch START to continue the timing countdown.

Changing or adding instructions

Your microwave oven is designed to let you change your mind while you are touching in instructions, and to let you change instructions after you have started the oven.

- **Cooking time** can be changed at any time during the cooking cycle:
 - Touch COOK.
 - Touch numbers for the new time.
 - Touch START.
 - The cycle will cook at the original Cook Power for the new time.
- **Cook Power** can be changed at any time during the cooking cycle, or PROBE TEMP:
 - Touch COOK POWER.
 - Touch a number for the new Cook Power.
 - Touch START. The Cycle will cook at the new Cook Power for the original time.
- **OR...**
 - Touch COOK POWER **twice** then touch start if you want to change a lower Cook Power to high.
- When using the Temperature Probe, **PROBE TEMP.** can be changed during operation:
 - Touch PROBE TEMP.
 - Touch number for new temperature.
 - Touch START. The oven will continue cooking to the new temperature. If the new temperature is lower than the temperature of the food, the oven will shut off.
- **COOK** can be added anytime while QUICK DEFROST is operating:
 - Touch COOK.
 - Touch in time and Cook Power Instructions.
 - Touch START.Standing time occurs between QUICK DEFROST and COOK.

Cancelling instructions

- Touch CANCEL **to erase all instructions** or beeps.
- Opening the oven door during cooking does not cancel cooking instructions.

Programming tone

Each time you touch a pad you will hear a tone. If you do not hear a tone, it is because the instruction is not correct, or it is because the tones have been removed.

EXAMPLE: If you forget to plug in the Temperature Probe and touch PROBE TEMP. you will not hear a tone. The instruction is not correct.

If you want to remove the tone:

- Open the door.
- Touch CANCEL **twice**, then START.
- The tone will not sound for any touch.

If you want to replace the tone:

- Open the door.
- Touch CANCEL **twice**, then START.
- The tone will sound for any correct touch.
- The programming tone will return after an electrical power outage.

Other operating hints

These are a number of things you can do with your microwave oven. Some will be reminders. Others will be mentioned for the first time.

1. **To double check settings** while the oven is running, touch the command pad for the setting you want to check. The instruction programmed for that pad will show on the Display for 5 seconds. Then the Display will return to show what the oven is doing.
2. **To stop the oven while it is running:**
 - Open the door. The oven will stop. You can restart it by closing the door and touching START.
 - Touch CANCEL. All instructions will be erased. You must touch in new instructions.
3. If you touch two instructions into the **same** cycle, the second instructions will erase the first.
4. When using a Cook Power other than high, the Display will show the Cook Power for 2 seconds of every 10 during cooking.
5. When COOK follows QUICK DEFROST, a standing time equal to the defrosting time will occur between the two. The COOK Cycle will automatically begin after this standing time.

Bi-level cooking

A removable Bi-Level Cooking Rack is available as an accessory kit. This rack lets you cook or reheat foods together as a meal. Ask your dealer for details on...

- RCK800 (832848) – Bi-Level Cooking Rack Kit

Operating safety precautions

DO NOT use the oven until you have read and understand **ALL** the information on safe use.

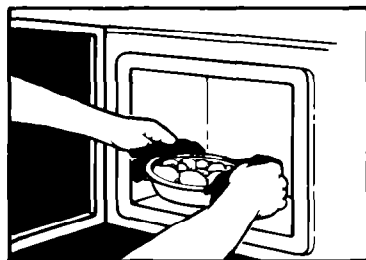

USE HOT PADS. Microwave energy does not heat containers, but the hot food does.



To test a dish for safe use, put it into the oven with a cup of water **beside it**. Cook on high Cook Power for one minute. **If the dish gets hot and water stays cool do not use it.**

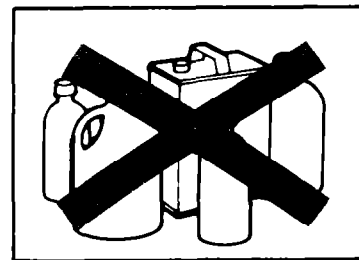

DO NOT heat or store flammable or inflammable materials in or near the oven.

(continued on page 18)

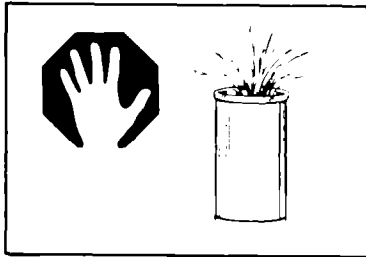

WARNING – Use care when heating liquids or adding ingredients to heated liquids. Liquids heated in certain shaped containers may become overheated. The liquid may splash out with a loud noise during or after heating or when adding ingredients (instant coffee, etc.). This can harm the oven and the hot liquid could burn you. Do not use such containers to heat liquids again.

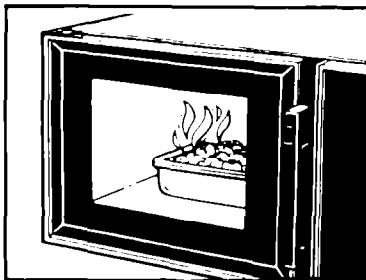

If a fire should start in the oven cavity:

- **keep door closed**
- **turn oven off**
- **disconnect the power supply** at the cord, fuse or circuit breaker.

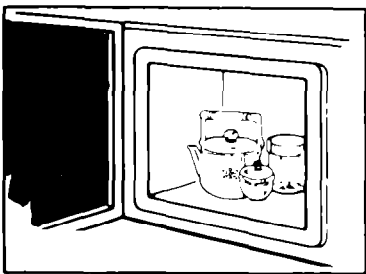

DO NOT use the oven for storage. Do not leave paper products, books or cooking utensils in the oven when not in use. Fire may result if someone accidentally starts the oven.

Don't let anything touch the top of the oven.

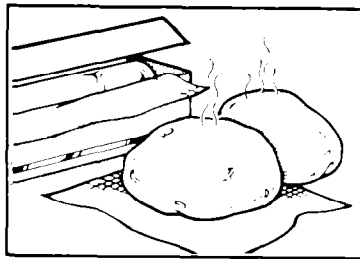

DO NOT OVERCOOK POTATOES. Fire could result. At the end of the recommended cooking time they should be slightly firm. Wrap in foil and set aside for 5 minutes. They will finish cooking while standing.

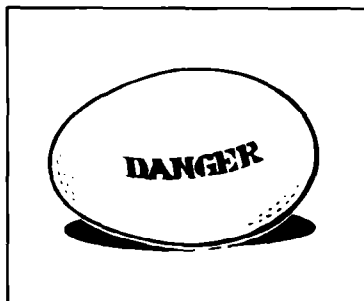

NEVER COOK OR REHEAT A WHOLE EGG.

Steam build-up in whole eggs may cause them to burst and burn you, and possibly damage the oven. Slice hard boiled eggs before heating. In rare instances, poached eggs have been known to explode. Cover poached eggs and allow a standing time of one minute before cutting into them.

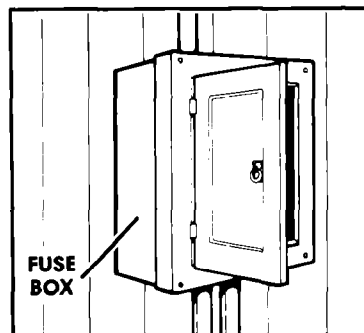

If your electric power line voltage is less than the normal 120 volts, cooking times may be longer.

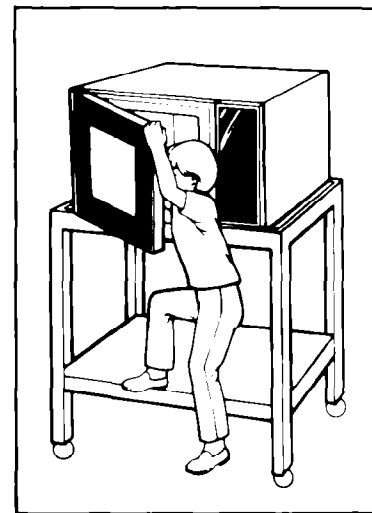

NEVER lean on the door or allow a child to swing on it when the door is open. Injury could result.

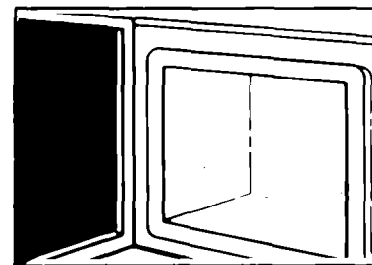

Starting a microwave oven when its empty is not recommended. If you experiment, put a container of water in the oven.

It is normal for the inside of the oven door to look wavy after the oven has been running for a while.

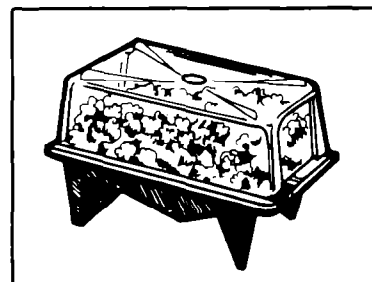

Make popcorn only in poppers designed for use in microwave ovens. Follow popper directions. Results are the popper manufacturer's responsibility.

Installation instructions

BEFORE YOU BEGIN, READ THE FOLLOWING INSTRUCTIONS COMPLETELY AND CAREFULLY.

Installing your microwave oven

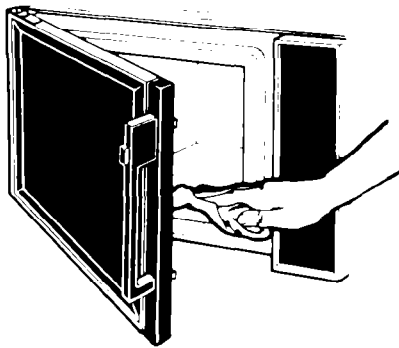

1. Empty the microwave oven and clean inside it with a soft, damp cloth. Check for damage such as misaligned door, damage around the door or dents inside the oven or on the exterior. If there is any damage, **do not** operate the unit until it has been checked by an authorized Whirlpool service technician and any repairs made.

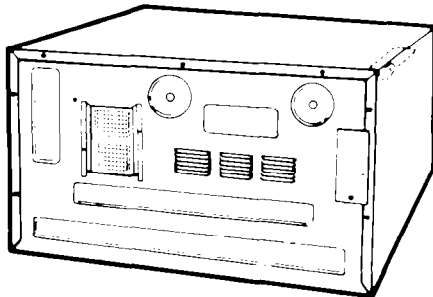

3. Do not block the vent openings on the rear of the oven or the air intake openings on the bottom of the oven. Blocking vent or air intake openings can cause poor cooking results. The air from these vent openings will also contain moisture and should not be vented onto overhead cabinets.

Make sure the microwave oven legs are in place. Do not set the oven on anything that will block the air intake openings.

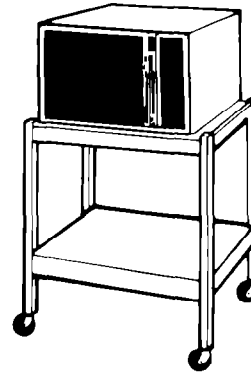

2. Put the oven on a cart, counter, table or shelf that is strong enough to hold the oven and the food and utensils you put in it. **(The control side of the unit is the heavy side. Use care when handling.)** The weight of the oven is approximately 70 lbs. (31.75 kg).

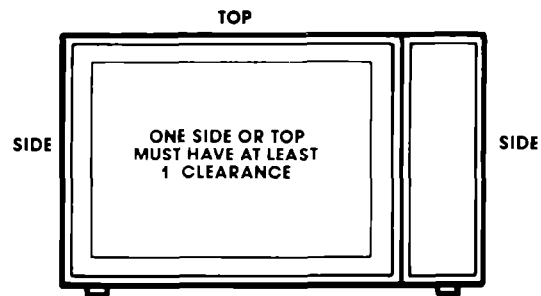

4. Do not install the microwave oven so that both sides and the top are flush with walls or cabinets. One side or the top must have at least 1 in. (2.54 cm) clearance for proper operation. Do not install the oven next to a conventional surface unit or in any area where excessive heat and steam are generated. This could damage the outside of the cabinet.

5. Electrical requirements

Observe all governing codes and ordinances.

A 120 Volt, 60 Hz, AC only, 15 amp fused electrical supply is required. (Time-delay fuse is recommended.) It is recommended that a separate circuit serving only this appliance be provided.

6. GROUNDING INSTRUCTIONS

WARNING: Improper use of the grounding plug can result in a risk of electrical shock.

An extension cord should not be used with this appliance. Such use may result in a fire, electrical shock or other personal injury.

DO NOT, UNDER ANY CIRCUMSTANCES, REMOVE THE POWER SUPPLY CORD GROUNDING PRONG.

7. For your personal safety, this appliance must be grounded. In the event of an electrical short circuit, grounding reduces the risk of electric shock by providing an escape wire for the electric current. This appliance is equipped with a

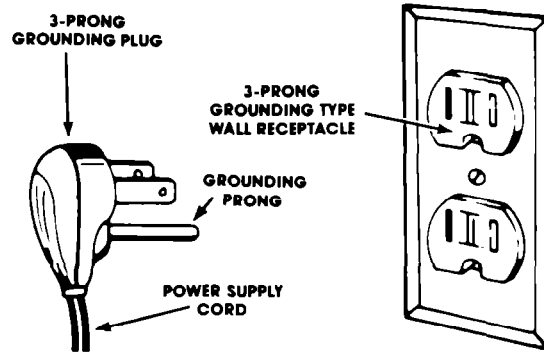

polarized 3-prong grounding plug. It must be plugged into a correctly polarized mating 3-prong grounding type wall receptacle, properly installed and grounded in accordance with the National Electrical Code and local codes and ordinances. If a mating wall receptacle is not available or if you are not sure if the wall receptacle is properly grounded and polarized, have it checked by a qualified electrician.

It is the personal responsibility and obligation of the customer to have a properly grounded and correctly polarized 3-prong wall receptacle installed by a qualified electrician.

Consult a qualified electrician if the grounding instructions are not completely understood, or if doubt exists as to whether the appliance is properly grounded.



8. Plug the oven into the proper electrical outlet and put about one cup (250 mL) of cold water in a glass container in the oven. Close the door. Make sure it latches. Follow the directions on page 6 to set the oven to COOK for 1½ minutes. When the time is up, the water should be heated.

9. This microwave oven is designed for use in the household only and must not be used for commercial purposes.

DO NOT remove the outer case, door, or control panel at any time. The unit is equipped with high voltage and should not be serviced unless by an authorized Whirlpool trained service technician.

SAVE THESE INSTRUCTIONS

Building in your microwave oven

Your microwave oven is not limited to carts, counters or tables. Custom installations are made easy with kits available from your dealer.

1. Build the microwave oven into a cabinet or wall by itself or over built-in single ovens in the Whirlpool RDE, REE, RGE, RB and SB model series or Imperial 7200 single gas ovens.
2. Attach the microwave oven to a wall by itself or with cabinets over it.
3. Put the microwave oven on the **MICRO SHELF®** Hood over a cooktop. The hood is available ducted or as a recirculating hood, and includes cooktop lights.

Ask your dealer for details on...

- RCK803 (832849) – 30-inch Built-in Kit
- RCK805 (832856) – 25¾-inch Built-in Kit
- RCK807 (832850) – 27-inch Built-in Kit
- RCK710 (832763) – Wall Mount Kit
- RCK811 (832875) – Wall Mount Vent Grille and Filter Kit
- RCK713 (832940) – Wall Mount Cookbook Storage Cabinet
- RH3330XL – MICRO SHELF® Hood
- RCK902 (832873) – Storage Cabinet for use with MICRO SHELF® Hood

Caring for your microwave oven

Cleaning the microwave oven



Wipe often with warm sudsy water and a soft cloth or sponge.

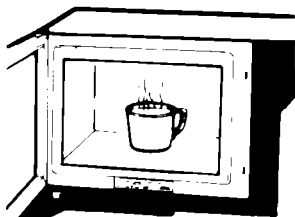

For stubborn soil, boil a cup of water in the oven for 2 or 3 minutes. Steam will soften the soil.

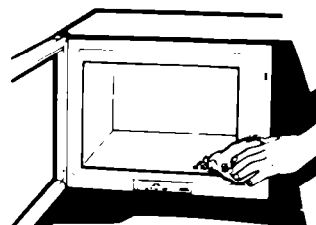

Be sure to clean the areas where the door and oven frame touch when closed. When cleaning surfaces of door and oven that come together on closing the door, use only mild, non-abrasive soaps or detergents applied with a sponge or soft cloth. Rinse well.

Caution:

Abrasive cleansers, steel wool pads, gritty wash cloths, etc., can damage the control panel and the interior and exterior oven surfaces. Use a soft cloth or a sponge with a mild detergent or spray glass cleaner.

Replacing the light bulb

1. Unplug the power cord.
2. Remove holding screw on access panel.
3. Remove the light bulb from its socket.
4. Replace bulb with a 40-watt **appliance** bulb.
5. Replace the access panel and holding screw.
6. Plug in the power cord.

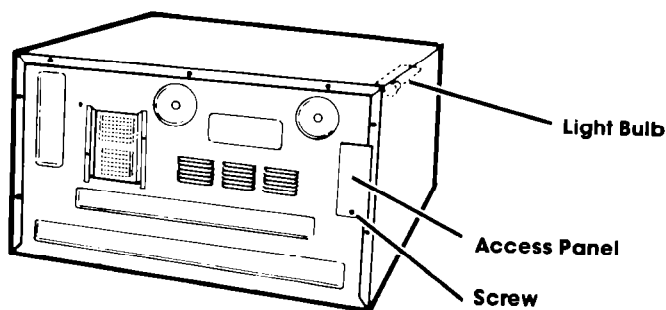

How your microwave oven works

Microwave ovens are safe. Microwave energy is not hot. It causes food to make its own heat, and it's this heat that cooks the food.

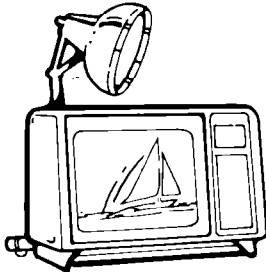

Microwaves are like TV waves or light waves. You can't see them, but you can see what they do.

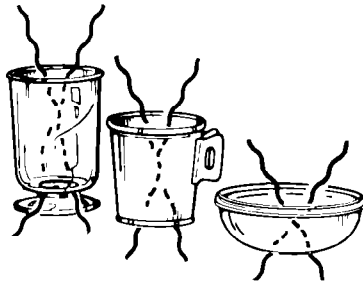

Microwaves pass through glass, paper and plastic without heating them so food absorbs the energy. Microwaves bounce off metal pans so food does not absorb the energy.

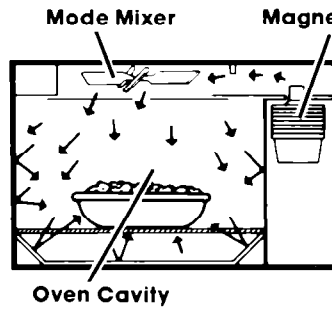

A magnetron in the microwave oven produces microwaves. The microwaves move into the oven where they are scattered or stirred by a mode mixer (like a fan). Microwaves bounce off metal oven walls and are absorbed by food.

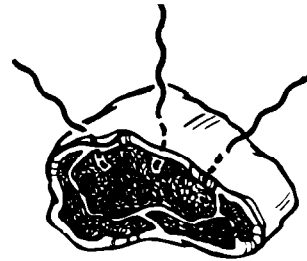

Microwaves may not reach the center of a roast. The heat around the outside is what cooks the roast all the way through. This is one of the reasons for letting some foods (roasts, baked potatoes) stand for a while after cooking, or for stirring some foods during the cooking time.

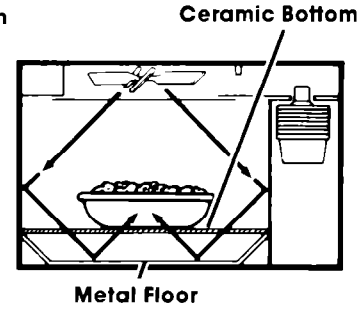

The ceramic bottom of your microwave oven lets microwaves through. Then they bounce off a metal floor, back through the ceramic bottom and are absorbed by the food.



The microwaves disturb water molecules in the food. As the molecules bounce around bumping into each other, heat is made, like rubbing your hands together. This is the heat that cooks.

If you need service or assistance, we suggest you follow these four steps:

1. Before calling for assistance...

Performance problems often result from little things you can find and fix yourself without tools of any kind:

If nothing operates:

- Is the oven correctly plugged into a live circuit with the proper voltage? (See page 20.)
- Have you checked the main fuse or circuit breaker box?

If the microwave oven will not run:

- Is the timer set?
- If the Temperature Probe is being used, is it plugged tightly into its socket?
- Is the door firmly closed and latched?
- Did you touch START?
- Did you follow the directions exactly?

If the microwave cooking times seem too long:

- Is the electric supply to your home low or lower than normal? Your electric company can tell you if the line voltage is low.
- Is the Cook Power set correctly?
- Are you allowing for more time when cooking more food at one time?

If the display shows the time counting down but the oven is not cooking:

- Is the oven door closed completely?
- Is the oven in a standing time between QUICK DEFROST and COOK. (See page 9.)
- Have you set the controls as a kitchen timer?

If you do not hear the Programming Tone (page 16):

- Is the command correct?
- Has the tone been cancelled?

If the fan seems to be running slower than usual:

- Has the oven been stored in a cold area? The fan will run slower until the oven warms up to normal room temperature.

If there has been a power interruption, the Display will show 88:88. Reset the clock (page 6).

If the microwave oven turns off too soon or not soon enough when using the probe:

- Is at least 1/3 of the probe in the food?
- Is the probe tip in the center of the food?
- Is the probe touching bone or fat?
- Have you allowed roasts to stand for a few minutes after cooking to equalize temperature?
- Is the probe plugged tightly into its socket?
- Is the Cook Power set correctly?
- Is the Probe Temperature set correctly?

2. If you need assistance*...

Call the Whirlpool COOL-LINE® service assistance telephone number. Dial free from:

Continental U.S. (800) 253-1301
 Michigan (800) 632-2243
 Alaska & Hawaii (800) 253-1121

and talk with one of our trained Consultants. The Consultant can instruct you on how to obtain satisfactory operation from your appliance or, if service is necessary, recommend a qualified service company in your area.

3. If you need service*...



Whirlpool has a nationwide network of franchised TECH-CARE® service Companies. TECH-CARE service technicians are trained to fulfill the product warranty and provide after-

warranty service, anywhere in the United States. To locate TECH-CARE service in your area, call our COOL-LINE service assistance telephone number (see Step 2) or look in your telephone directory Yellow Pages under:

APPLIANCES - HOUSEHOLD - MAJOR - SERVICE & REPAIR	OR	ELECTRICAL APPLIANCES - MAJOR - REPAIRING & PARTS
WHIRLPOOL APPLIANCES FRANCHISED TECH-CARE SERVICE		WHIRLPOOL APPLIANCES FRANCHISED TECH-CARE SERVICE
SERVICE COMPANIES		
XYZ SERVICE CO 123 Maple 999-9999		XYZ SERVICE CO 123 Maple 999-9999
OR		
WASHING MACHINES, DRYERS & IRONERS - SERVICING		
WHIRLPOOL APPLIANCES FRANCHISED TECH-CARE SERVICE		
SERVICE COMPANIES		
XYZ SERVICE CO 123 Maple 999-9999		

4. If you have a problem*...

Call our COOL-LINE service assistance telephone number (see Step 2) and talk with one of our Consultants, or if you prefer, write to:

Mr. Guy Turner, Vice President
 Whirlpool Corporation
 Administrative Center
 2000 U.S. 33 North
 Benton Harbor, MI 49022

*If you must call or write, please provide: model number, serial number, date of purchase, and a complete description of the problem. This information is needed in order to better respond to your request for assistance.



Making your world a little easier.

Part No. 311879
©1984 Whirlpool Corporation

Printed in U.S.A.

Ice Makers, Dishwashers, Built-In Ovens and Surface Units, Ranges, Microwave Ovens, Trash Compactors, Room Air Conditioners, Dehumidifiers, Automatic Washers, Clothes Dryers

